

AB Submersible Propeller Pump

OPERATION MANUAL

INTRODUCTION

Thank you for selecting the Tsurumi AB Submersible Propeller Pump for your application.

This equipment should not be used for applications other than those listed in this manual. Failure to observe this precaution may lead to a malfunction or an accident. In the event of a malfunction or an accident, the manufacturer will not assume any liability. After reading this Operation Manual, keep it in a location that is easily accessible, so that it can be referred to whenever information is needed while operating the equipment.

CONTENTS

1. PART NAMES	1
2. PRIOR TO USE	1
3. INSTALLATION	2
4. ELECTRICAL WIRING	4
5. OPERATION	6
6. MAINTENANCE AND INSPECTION	8
7. DISASSEMBLY AND REASSEMBLY PROCEDURE	10
8. TROUBLESHOOTING	11

TSURUMI MANUFACTURING CO., LTD.

MADE IN JAPAN

1 PART NAMES

■ Example

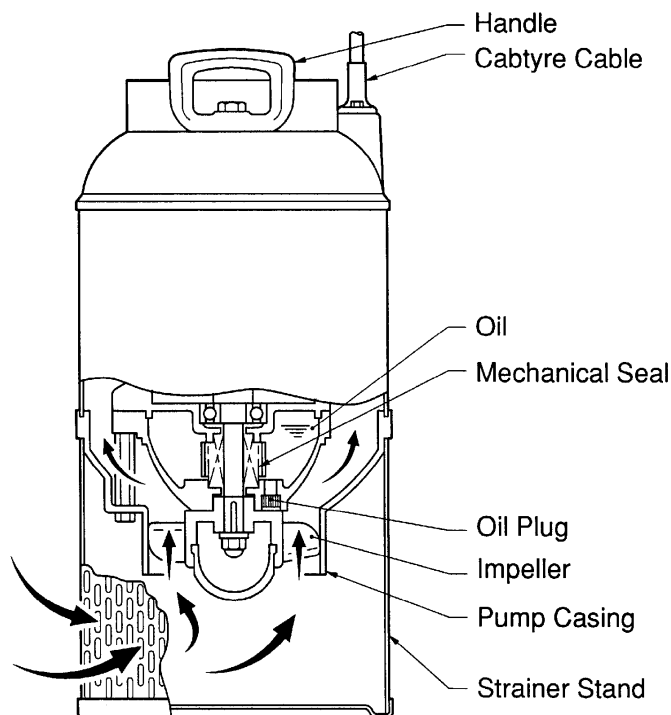

2 PRIOR TO OPERATION

After unpacking, verify the contents.

Product Inspection

Inspect the product for damage during shipment, and make sure all bolts and nuts are tightened properly.

Specification Check

Check the nameplate of the unit to verify that it is the product that you have ordered. Pay particular attention to its voltage and frequency specifications.

Accessory Check

Verify that all accessory items are included in the package.

Operation Manual 1

Note: *If you discover any damage or discrepancy in the product, please contact the dealer where this equipment was purchased or the Tsurumi sales office in your area.*

Product Specifications

CAUTION Do not operate this product under any conditions other than those that have been specified.

Major Standard Specifications

Applicable Liquids	Consistency and Temperature	River water and Agricultural water ; 0 ~ 40°C
Pump	Impeller	Propeller
	Shaft Seal	Double Mechanical Seal
	Bearing	Sealed Ball Bearing
Motor	Specifications	Dry Submersible Induction Motor, 2,4-Pole
	Insulation	Class E
	Protection System (built-in)	Circle Thermal Protector
	Lubricant	Turbine Oil VG32 (non-additive)
Connection		Special Screw

3 INSTALLATION

CAUTION

- Do not use the pump for pumping liquids other than water, such as oil, salt water, or organic solvents.
- The supply voltage should be within $\pm 5\%$ of the rated voltage.
- The water temperature for operating the pump should be between 0 ~ 40°C. Failure to observe the precautions given above could cause the pump to malfunction, which may lead to current leakage or electrical shock.

Note: To use the pump for a special solution, contact the dealer where it was purchased, or the Tsurumi sales office in your area.

Critical Use Pressure

CAUTION Do not operate the pump in an area that is exposed to a water pressure that exceeds the values given below.

Applicable Pump	Critical Use Pressure
Models with output of 0.75kW or under	0.2MPa (2kgf/cm ²) - discharge pressure during use
Models with output of 1.5kW	0.3MPa (3kgf/cm ²) - discharge pressure during use

Preparation for Installation

Single-phase power supply:

Use a megger to measure the resistance between the tip of the cable plug and the ground terminal to verify the insulation resistance of the motor.

(This diagram shows a 2-pin plug type.)

Three-phase power supply:

Use a megger to measure the resistance between each core of the cable and the (green) ground wire to verify the insulation resistance of the motor.

Insulation resistance reference value
= 20M Ω minimum

Single-Phase

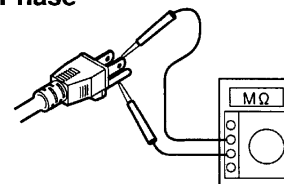

Three-Phase

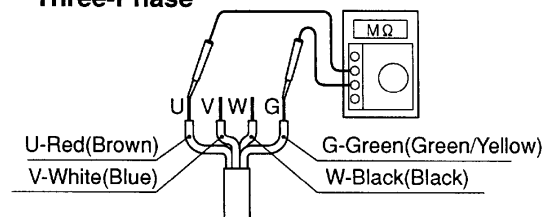

Note: The insulation resistance reference value of 20M Ω minimum is based on a new or repaired pump. For reference values of a pump that has already been put into operation, refer to "6. Maintenance and Inspection" of this manual.

Precautions During Installation

WARNING When installing the pump, be mindful of the pump's center of gravity and weight. If the pump is not suspended properly, the pump may fall and break, which may lead to injury.

CAUTION When installing or moving the pump, never suspend the pump by the cable. Doing so will damage the cable, which may cause a current leakage, electrical shock, or fire.

When a hose is used, attach the hose to the screw-on hose coupling as far as it will go, then fasten it securely with the hose bands.

Using a hose

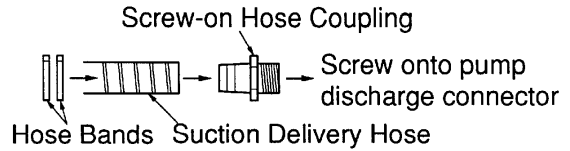

When PVC pipe is used, attach the pipe onto the socket as far as it will go, then bond it with adhesive.

Using a PVC pipe

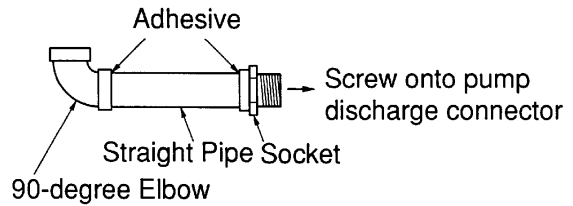

Handle the pump carefully without applying shock to it, such as by dropping it. To suspend the pump, do so manually or by attaching ropes to its handles.

CAUTION The rope for suspending the pump during its installation must be of a thickness that accommodates the weight of the pump. When using a chain, make sure that the chain does not become twisted. Failure to observe these precautions could cause the rope or chain to break and the pump to fall and break, which could lead to personal injury.

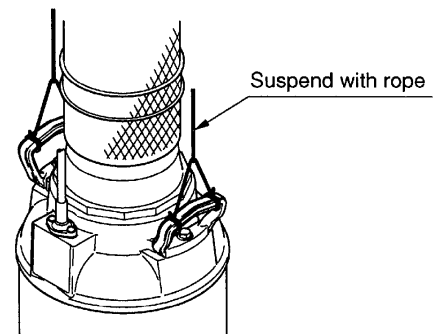

Operate the pump in a location that has a sufficient water level and collects water easily.

CAUTION If the pump draws in a large amount of mud, it could cause the pump to wear prematurely and lead to a malfunction, current leakage, and electrical shock.

Note: For the water level required for operating the pump, refer to the external dimension drawing, which is provided separately. Extend the end of the hose (discharge side) above the water surface. If the end of the hose is submerged in water, it may cause the water to flow back when the pump has been stopped. Conversely, if the end of the hose is located at a level that is lower than the source water surface, water may continue to flow out even after the pump has been stopped.

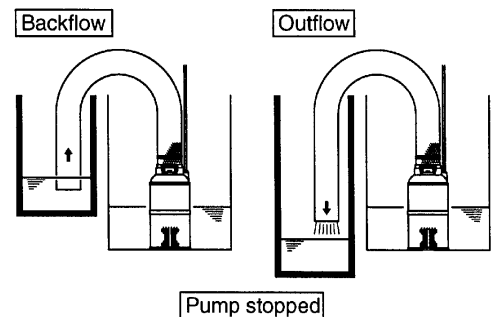

4 ELECTRICAL WIRING

Electrical Wiring Work



WARNING

- All electrical work must be performed by an authorized electrician, in compliance with local electrical equipment standards and internal wiring codes. Never allow an unauthorized person to perform electrical work because it is not only against the law, but it can also be extremely dangerous.
- Improper wiring can lead to current leakage, electrical shock, or fire.
- Be sure to use a dedicated ground leakage circuit breaker and overcurrent protector provided exclusively for this unit, to prevent the pump from being damaged. Failure to observe this precaution may lead to current leakage and electrical shock.

Operate well within the capacity of the power supply and wiring.

Grounding



WARNING

Be sure to install the ground wire securely. Failure to observe this precaution could damage the pump and cause current leakage, which may lead to electrical shock.



CAUTION

Do not connect the ground wire to a gas pipe, water pipe, lightning rod, or telephone ground wire. Improper grounding could cause electrical shock.

Connecting the Power Plug



WARNING

Before inserting the power plug or connecting the wires to the terminal board, make sure that the power supply (i.e. circuit breaker) is properly disconnected. Failure to do so may lead to electrical shock, short, or injury caused by the unintended starting of the pump.



CAUTION

Do not use damaged cable cables, power plugs, or loose power outlets. Failure to observe this precaution could lead to electrical shock, short circuit, or fire.

Follow the diagram on the right to connect the power.

When using a three-prong grounded plug, connect as shown in the drawing.



CAUTION

Be sure to use a dedicated power supply with a ground leakage circuit breaker.

(This diagram shows a 2-pin plug type.)

Note: *the shape of the plug may differ from that shown in the illustration.*

When a single-phase power source is used, connect the leads to the control panel terminals as shown in the diagram, making sure they do not become twisted together.

When a three-phase power source is used, connect the leads to the control panel terminals as shown in the diagram, making sure they do not become twisted together.

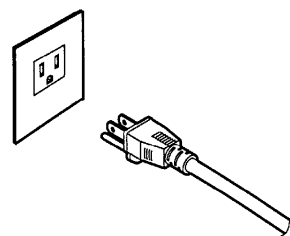

Single Phase

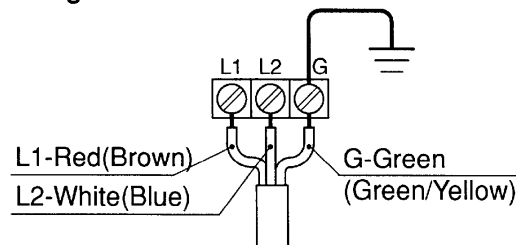

Three Phase

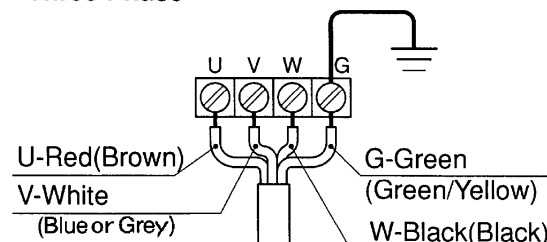

Motor Protector

The pump is equipped with a built-in motor protector (circle thermal protector).

If a current overload or overheating occurs under the symptoms given below, the pump will stop automatically to protect the motor regardless of the water level at the time of operation.

- Extreme fluctuation of power supply voltage
- Pump operated under overload condition
- Pump operated at open phase or binding condition

Note: *After the motor protector has tripped, the motor automatically resumes its operation. Therefore, make sure to disconnect the cable from the terminal board or the power outlet, and eliminate the cause of the problem. Do not operate the pump at unusually low head, or with the impeller clogged with debris. Doing so will not only prevent the pump from attaining its full potential, but may also generate abnormal noise and vibration and damage the pump.*

Electrical Circuit Diagrams

Power Supply: Single-Phase

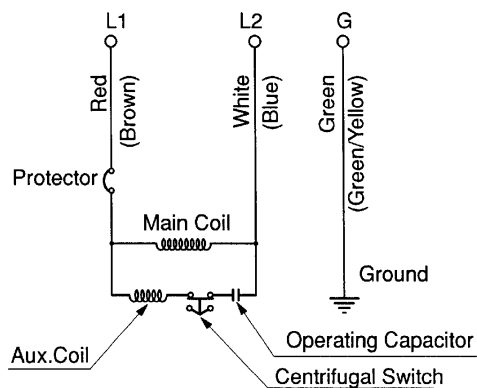

Power Supply: Three-Phase

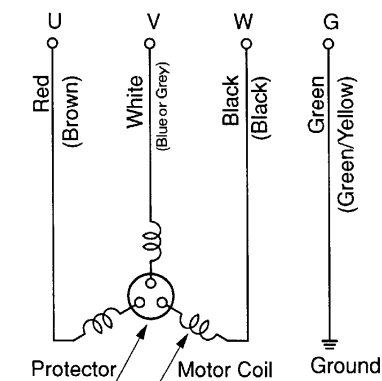

5 OPERATION

► Prior to Operation

- (1) Once again, check the nameplate of the pump to verify that its voltage and frequency are correct.

⚠ CAUTION Improper voltage and frequency of the power supply will prevent the pump from attaining its full potential, and may also damage the pump.

Note: Verify the specs on the pump's nameplate.

- (2) Check the wiring, power supply voltage, the capacity of the ground leakage circuit breaker, and the insulation resistance of the motor.

■ Insulation resistance reference value = 20M Ω minimum

Note: The insulation resistance reference value of 20M Ω minimum is based on a new or repaired pump. For reference values of a pump that has already been put into operation, refer to "Maintenance and Inspection".

- (3) Adjust the setting of the thermal relay (i.e. 3E relay) to the pump's rated current.

Note: Verify the rated current on the pump's nameplate.

► Trial Operation

⚠ WARNING Never start the pump while it is suspended, as the pump may jerk and cause a serious accident involving injury.

- (1) Operate the pump for a short time (1 to 2 seconds) and verify the direction of the rotation of the impeller. Observe the pump unit from above, and if its recoil is in the counterclockwise direction, the direction of its rotation is correct.

⚠ CAUTION Make sure to check the pump's direction of rotation with the pump exposed to the atmosphere. Operating the pump in reverse while it is submerged in water will damage the pump, which may lead to current leakage and electrical shock.

- (2) To reverse the rotation, the following countermeasures must be taken.

⚠ WARNING Before changing the connections for reverse rotation, make sure that the power supply (i.e. circuit breaker) is properly disconnected and that the impeller has stopped completely. Failure to observe this may lead to electrical shock, short, or injury.

COUNTERMEASURE

Direct-on-line starting
Interchange any two of the three wires designated U, V, and W, respectively.

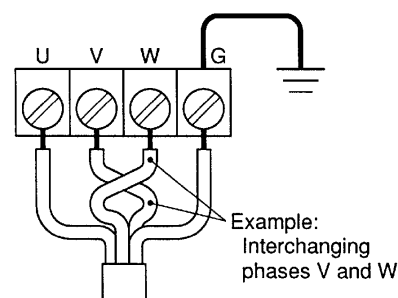

(3) Connect the pump to the pipe and submerge it in water.

(4) Operate the pump for a short time (3 to 10 minutes) and perform the following checks:

Using an AC ammeter (clamp), measure the operating current at the phases U, V, and W that are connected to the terminal board.

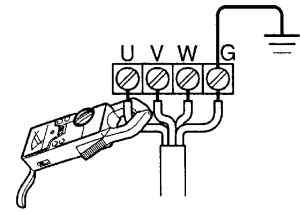

COUNTERMEASURE

Because an overload condition may be present at the pump motor if the operating current exceeds the rated current, follow the instructions in section "3. Installation" to operate the pump in the correct manner.

Using an AC voltmeter (tester), measure the voltage at the terminal board.

■ Power supply voltage tolerance = within $\pm 5\%$ of the rated voltage

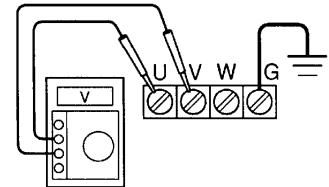

COUNTERMEASURE

If the power supply voltage deviates from the tolerance value, the cause of the deviation may be the capacity of the power supply or the extension cable that is used. Refer to section "4. Electrical Wiring" to operate the pump in the correct manner.

⚠ CAUTION

In case the pump exhibits an abnormal condition (such as a considerable amount of vibration, noise, or smell), disconnect the power supply immediately and contact the dealer where you purchased the equipment, or Tsurumi's sales office in your area. If the pump continues to be used in the abnormal state, it may cause current leakage, electrical shock, or fire.

(5) Proceed with the normal operation if no abnormal conditions are found during the trial operation.

▶ Operation

⚠ **WARNING** The pump unit may be extremely hot during operation. To prevent burns, do not touch the pump unit with bare hands during or after the operation.

Pay attention to the water level during the pump operation. The pump will become damaged if it is allowed to operate dry.

Due to an overload operation or a pump malfunction, if the motor protector trips to stop the pump, make sure to eliminate the cause of the problem before restarting.

To operate a submersible pump (including automatic operation), set the water level so that the pump will operate about 5~6 times per hour.

Note: A large amount of amperage flows when a submersible pump is started, causing the temperature of its windings to rise rapidly. Beware that a frequent stop-and-go operation of the pump will accelerate the deterioration of the insulation of the motor windings and thus affect the use life of the motor.

▶ Operating Water Level

⚠ **CAUTION** Do not operate the pump at the lowest water level longer than 30 minutes, as it could damage the pump, causing current leakage and electrical shock. For details on the lowest water level, refer to the dimension drawing, which is provided separately.

Storage

If the pump will not be operated for a long period of time, pull the pump up, wash the pump, allow it to dry, and store it indoors.

Note: For reinstallation, be sure to perform a trial operation before putting the pump into operation.

If the pump remains immersed in water, operate it on a regular basis (i.e. once a week).

Oil Inspection and Changing Procedures

Inspecting Oil

Inspect the oil as follows:

- (1) Using a screwdriver, remove the Phillips screws and plain washers to remove the strainer stand.
- (2) Remove the hex nut and the spring washer to remove the pump casing, outer cover, and the upper and lower square packings.
- (3) Remove the impeller thread protection cap with a screwdriver, and the hex nut with a box wrench. Then, remove the impeller and the impeller adjusting washer.
- (4) Remove the oil plug with a hex key wrench.
- (5) Stand the unit upright and drain the oil. If the drained oil appears milky or intermixed with water, a likely cause is a defective shaft sealing device (i.e. mechanical seal), which requires that the pump be disassembled and repaired.

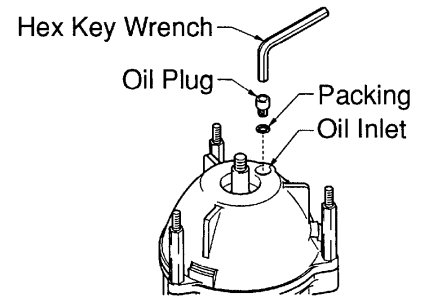

Specified Oil: Turbine Oil VG32 (non-additive)

Unit : ml

Applicable Model	Specified Volume
Model with 0.4 ~ 0.75kW power output	160
Model with 1.5kW power output	600

Changing Oil

Remove the oil plug and drain the oil completely. Pour a specified volume of oil into the oil filler inlet.

Note: The drained oil must be disposed of properly to prevent it from being released into the sewer or rivers. The packing or the O-ring for the oil plug must be replaced with a new part at each oil inspection and change.

7

DISASSEMBLY AND REASSEMBLY PROCEDURE

Prior to Disassembly and Reassembly

**WARNING**

Before disassembling and reassembling the pump, be sure that the power supply (i.e. circuit breaker) is disconnected, and remove the cable from the outlet or the terminal board. Do not connect or disconnect the power plug with a wet hand, in order to prevent electrical shock. Do not perform an activation test (to check the rotation of the impeller) during disassembly and reassembly. Failure to observe this precaution could lead to a serious accident, including injury.

This section explains the disassembly and reassembly processes that are involved up to the replacement of the impeller itself. Operations involving the disassembly and reassembly of the sealing portion (i.e. mechanical seal) and of the motor require a specialized facility including vacuum and electrical test equipment. For these operations, contact the dealer where this equipment was purchased, or the Tsurumi sales office in your area.

Disassembly Procedure

- (1) Removing the strainer stand
Using a screwdriver, remove the Phillips screws and plain washers to remove the strainer stand.
- (2) Removing the pump casing and outer cover
Remove the hex nut and the spring washer to remove the pump casing, outer cover, and the square packings.
- (3) Removing the impeller
Remove the impeller thread protection cap with a screwdriver and the hex nut with a box wrench. Then, remove the impeller and the impeller adjusting washer.

Disassembly Diagram

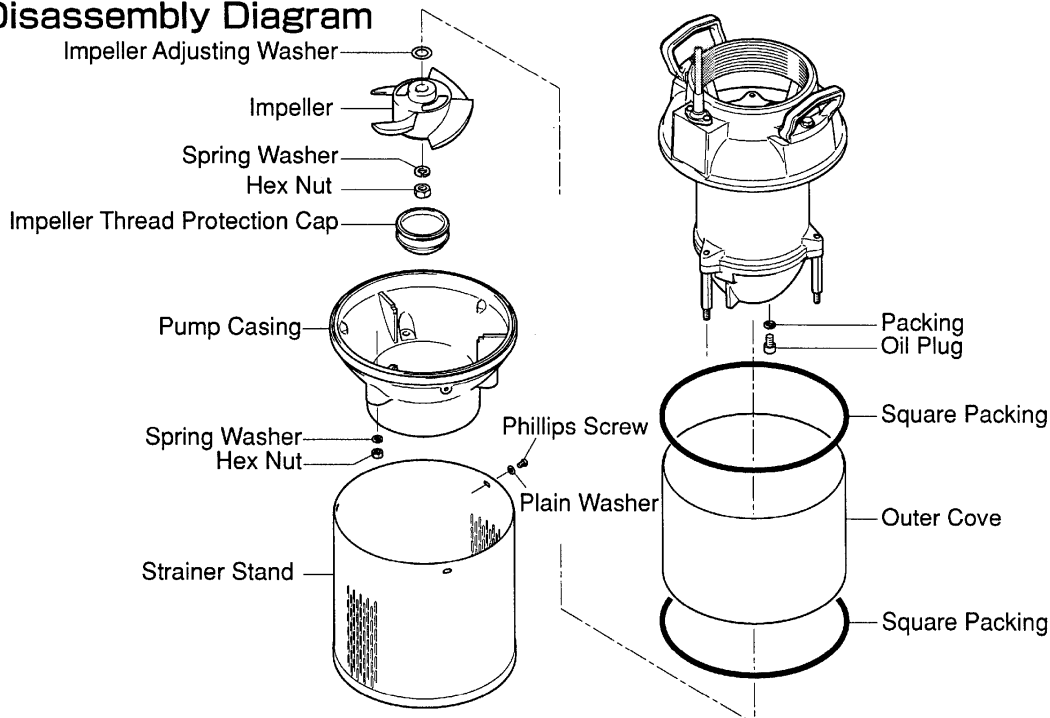

Reassembly Procedure

Observe the precautions given below and reassemble the unit in the reverse order of disassembly.

Note: Make sure to pour in the specified amount of oil before reassembly. Replace the packings with new ones.

If there are other parts that are worn or damaged, also replace them with new ones. When installing the outer cover, do not forget to also install the upper and lower square packings.

After installing the impeller, make sure that it rotates smoothly.

8 TROUBLESHOOTING

⚠ WARNING To prevent serious accidents, disconnect the power supply before inspecting the pump.

Read this Operation Manual carefully before requesting repair. After re-inspecting the pump, if it does not operate normally, contact the dealer where this equipment was purchased, or the Tsurumi sales office in your area.

Symptom	Cause	Countermeasure
Pump fails to start.	<ul style="list-style-type: none"> ① No proper power is supplied (i.e. power outage). ② Open circuit in cabtyre cable or poor connection. ③ Foreign matter is wedged in the propeller, causing the motor protector to trip. 	<ul style="list-style-type: none"> ① Contact the electric power company or an electrical repair shop. ② Check whether there is an open circuit in the cabtyre cable or wiring. ③ Inspect the pump and remove the debris.
Pump starts but stops immediately, causing the motor protector to trip.	<ul style="list-style-type: none"> ① Foreign matter is wedged in the impeller or the pump casing is filled with mud. ② The voltage is too low. ③ A 50Hz pump is used at 60Hz. ④ The pump has been operated for a long time with its strainer stand clogged. ⑤ The motor is faulty. ⑥ The pump is drawing in too much mud. 	<ul style="list-style-type: none"> ① Remove the strainer stand, remove the debris, and spin the impeller by hand. ② Provide the rated voltage or use an extension cable that meets the specifications. ③ Check the nameplate and replace the pump or the impeller. ④ Remove the debris from the strainer stand. ⑤ Repair the motor or replace it with a new one. ⑥ Place a concrete block under the pump to prevent the pump from drawing in excess mud.
The pumping volume is low.	<ul style="list-style-type: none"> ① The impeller is worn. ② The hose is clogged or kinked at its midspan. ③ The strainer stand is clogged or is buried. ④ The motor rotates in reverse. 	<ul style="list-style-type: none"> ① Replace the impeller. ② Minimize the bends of the hose, and if the pump is used in a dusty area, place it inside a mesh basket during operation. ③ Remove the debris from the strainer stand. Place a concrete block under the pump to prevent the pump from drawing in excess mud. ④ Change the power connection.
The pump generates vibration or noise.	<ul style="list-style-type: none"> ① The pipe support is loose. ② Motor bearings are damaged. 	<ul style="list-style-type: none"> ① Secure the pipe support. ② Replace the motor bearings.

The following information is required when ordering repairs or making other inquiries.

Product model	
Manufacturing number	
Purchase date	
Remarks	

Disposal of Product

Properly dispose of the product by disassembling it, presorting the contents, and sending them to the waste material treatment site.