



Stream your
discoveries



**STREAM
VISION**



TRAIL **LRF** Thermal Imaging Sights

I N S T R U C T I O N S

ENGLISH



Class 1 Laser Product

Caution - use of controls or adjustments or performance of procedures other than those specified herein may result in hazardous radiation exposure.



LRF Laser aperture

Electromagnetic compliance

This product complies with EU Standard EN 55032:2015, Class A.
Warning! Operation of this equipment in a residential environment could cause radio interference.

Attention! Trail LRF thermal imaging sights require a license if exported outside your country.

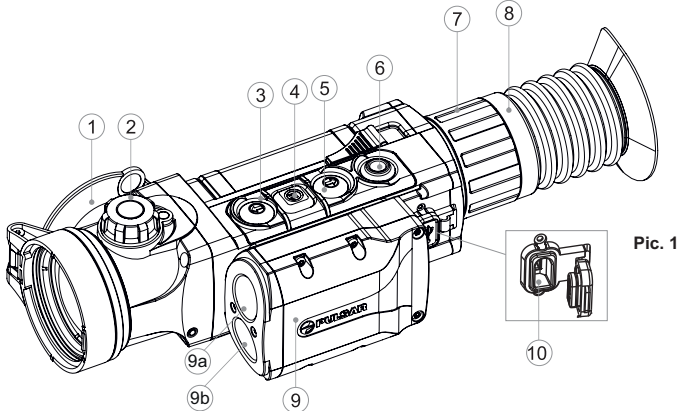

Pic. 1

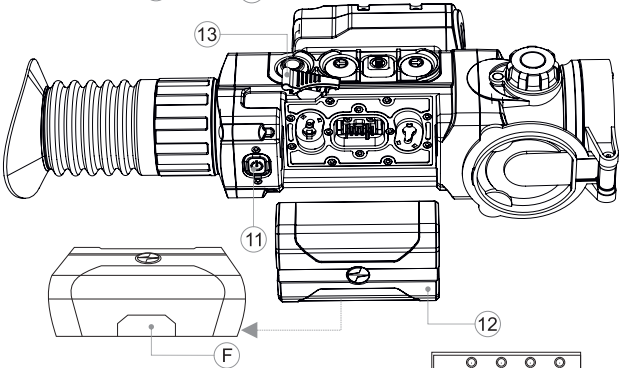

Pic. 2

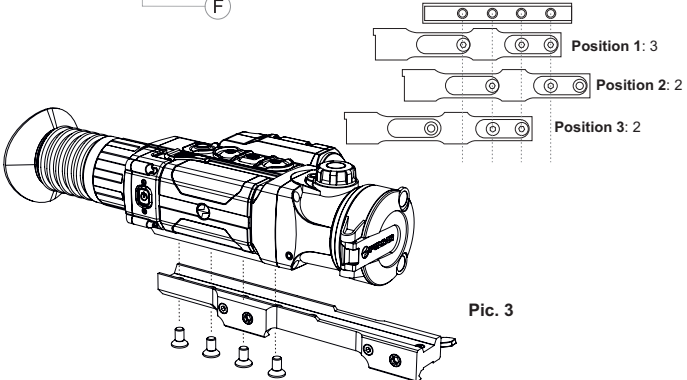

Pic. 3

SPECIFICATIONS

MODEL TRAIL LRF SKU#	XQ28 76514	XQ38 76516	XQ50 76503
Microbolometer:			
Type	uncooled	uncooled	uncooled
Resolution, pixels	384x288	384x288	384x288
Frame rate, Hz	50	50	50
Pixel size, µm	17	17	17
Optical characteristics:			
Objective lens	F28mm, F/1.2	F38mm, F/1.2	F50mm, F/1.2
Magnification, x	1.5	2.1	2.7
Continuous digital zoom, x	1.5-6	2.1-8.4	2.7-10.8
Digital zoom, x	x2/x4	x2/x4	x2/x4
Eye relief, mm	50	50	50
Field of view (H), degrees m@100m	13.3 23.3	9.8 17.2	7.5 13.1
Dioptr adjustment, D	±4	±4	±4
Max. observation range of an animal 1.7m tall, such as deer, m/y	800/ 845	1350/ 1476	1800/ 1969
Close-up range, m	5	5	5
Reticle			
Click value, mm at 100 m (H/V)	36/36	27/27	20/20
Click range, mm@100m (H/V)	7200/7200	5400/5400	4000/4000
Display:			
Type	AMOLED	AMOLED	AMOLED
Resolution, pixels	640x480	640x480	640x480
Power supply			
Battery type / Capacity / Output voltage	Li-Ion Battery Pack IPS5 / 5000 mAh / DC 3.7V		
Power supply	3 – 4.2V	3 – 4.2V	3 – 4.2V
External power supply	5V (USB)	5V (USB)	5V (USB)
Max. operating time on Battery Pack (at t=22°C), hours*	8	8	8
Max. recoil power on rifled weapon, Joules	6000	6000	6000
Max. recoil power on smooth-bore weapon, Joules	12	12	12
Degree of protection, IP code (IEC60529)	IPX7	IPX7	IPX7
Operating temperature range	-25 °C... +50 °C / -13 °F... 122 °F		
Dimensions (LxWxH), mm	287x72x67	285x72x76	292x72x76
inch	11.3x.2.8x2.6	11.2x2.8x2.9	11.5x2.8x2.9
Weight (w/o batteries, mount), kg/oz	0.48 / 16.9	0.52 / 18.3	0.56 / 19.8
Video recorder			
Video / photo resolution, pixel	640x480	640x480	640x480
Video / photo format	.avi / .jpg	.avi / .jpg	.avi / .jpg
Built-in memory	8 Gb	8 Gb	8 Gb
Built-in memory capacity	150 min video or >10 000 pictures		
Wi-Fi channel			
Frequency	2.4GHz	2.4GHz	2.4GHz
Standard	802.11 b/g/n	802.11 b/g/n	802.11 b/g/n
Line-of-sight reception range, m	15	15	15
Characteristics of the rangefinder			
Wavelength, nm	905	905	905
Max. measuring range, m/y**	1000 / 1094	1000 / 1094	1000 / 1094
Measurement accuracy, m	+/-1	+/-1	+/-1

* Actual operating time depends on the intensity of using Wi-Fi, video recorder, laser rangefinder.
** Depends on the characteristics of the object under observation and environmental conditions.

MODEL TRAIL LRF SKU#	XP38 76517	XP50 76519
Microbolometer:		
Type	uncooled	uncooled
Resolution, pixels	640x480	640x480
Frame rate, Hz	50	50
Pixel size, µm	17	17
Optical characteristics:		
Objective lens	F38mm, F/1.2	F50mm, F/1.2
Magnification, x	1.2	1.6
Continuous digital zoom, x	1.2-9.6	1.6-12.8
Digital zoom	x2/x4/x8	x2/x4/x8
Eye relief, mm	50	50
Field of view (H), degrees m@100m	16.3 28.6	12.4 21.8
Dioptr adjustment, D	±4	±4
Max. observation range of an animal 1.7m tall, such as a deer, m / y	1350 / 1476	1800 / 1969
Close-up range, m	5	5
Reticle		
Click value, mm at 100 m (H/V)	45/45	34/34
Click range, mm@100m (H/V)	9000/9000	6800/6800
Display:		
Type	AMOLED	AMOLED
Resolution, pixels	640x480	640x480
Power supply		
Battery type / Capacity / Output voltage	Li-Ion Battery Pack IPS5 / 5000 mAh / DC 3.7V	
Power supply	3 – 4.2V	3 – 4.2V
External power supply	5V (USB)	5V (USB)
Operating time on Battery Pack (at t=22°C), hours*	8	8
Max. recoil power on rifled weapon, Joules	6000	6000
Max. recoil power on smooth-bore weapon, Joules	12	12
Degree of protection, IP code (IEC60529)	IPX7	IPX7
Operating temperature range, °C	-25 °C... +50 °C / -13 °F... 122 °F	
Dimensions (LxWxH), mm	285x72x67	292x72x67
inch	11.2x2.8x2.6	11.5x2.8x2.6
Weight (without batteries and mount), kg	0.67 / 23.6	0.71 / 25
Video recorder		
Video / photo resolution, pixel	640x480	640x480
Video / photo format	.avi / .jpg	.avi / .jpg
Built-in memory	8 Gb	8 Gb
Built-in memory capacity	150 min video or >10 000 pictures	
Wi-Fi channel		
Frequency	2.4GHz	2.4GHz
Standard	802.11 b/g/n	802.11 b/g/n
Line-of-sight reception range, m	15	15
Characteristics of the rangefinder		
Wavelength, nm	905	905
Max. measuring range, m/y**	1000 / 1094	1000 / 1094
Measurement accuracy, m	+/-1	+/-1

* Actual operating time depends on the intensity of using Wi-Fi, video recorder, laser rangefinder.

** Depends on the characteristics of the object under observation and environmental conditions.

● PACKAGE CONTENTS

- Thermal Imaging Sight
- IPS5 Battery Pack
- Battery charger with mains charger
- Wireless remote control
- Carrying case
- MicroUSB cable
- Mount (with screws and hex-nut wrench(-es))*
- User manual
- Lens cloth
- Warranty card

* Mount may not be included for certain orders.

This product is subject to change in line with improvements to its design.
The latest edition of this user manual is available online at www.pulsar-nv.com

● DESCRIPTION

Thermal imaging sights **TRAIL LRF** are designed for the use on hunting rifles both in the nighttime and in the daylight in inclement weather conditions (fog, smog, rain) to see through obstacles hindering detection of targets (branches, tallgrass, thick bushes etc.). Unlike the image intensifier tube based night vision riflescopes, thermal imaging sights do not require an external source of light and are not affected by bright light exposure. **TRAIL LRF** sights are equipped with a high precision built-in laser rangefinder which allows distance measurement up to 1000 metres.

The **TRAIL LRF** sights have a wide range of applications including night hunting, observation and terrain orientation, search and rescue operations.

● FEATURES

- Built-in precise laser rangefinder
- High resolution thermal imaging sensor
- Long detection distance up to 1800 m
- Smooth and incremental digital zoom
- High caliber recoil resistance 12 gauge, 9.3x64, .375 H&H
- High refresh rate 50 Hz
- Zeroing profiles memorization
- Frost resistant AMOLED screen
- Built-in video recorder
- Built-in Wi-Fi module
- Quick-change long-life rechargeable battery packs

- “Picture-in-Picture” mode
- Manual contrast and brightness adjustment
- Variable electronic reticles
- Various observation modes
- Three calibration modes

● EXTERNAL VIEW AND CONTROLS

- ① Lens cover
- ② Lens focusing ring
- ③ Button **UP**
- ④ Button **MENU (M)**
- ⑤ Button **DOWN**
- ⑥ Button **REC**
- ⑦ Dioptre adjustment ring
- ⑧ Eyeshade
- ⑨ Laser rangefinder
- ⑨a Rangefinder’s signal emitter
- ⑨b Rangefinder’s signal receiver
- ⑩ MicroUSB port
- ⑪ Button **ON**
- ⑫ Battery Pack
- ⑬ Lever for Battery Pack
- ⑭ Rail for mount installation

Please see the scheme on the front flyleaf.

DESCRIPTION OF CONTROLS

BUTTON	SIGHT STATUS (CURRENT OPERATING MODE)	FIRST SHORT PRESS	OTHER SHORT PRESSES	LONG PRESS
ON (11) ⏻	Sight is off	Power sight on	Calibrate the sensor	Turn display off/ Power sight off
	Display off	Turn display on	Calibrate the sensor	
	Sight is on	Calibrate the sensor		
UP (3) ↑	Regular (observation)	Activate rangefinder		Switch color palettes
	Rangefinder	Distance measurement		SCAN mode ON/OFF
	Menu navigation	Navigation upwards/rightwards		
MENU (4) M	Regular (observation)	Enter quick menu		Enter main menu
	Main menu	Confirm selection		Exit submenu without confirming selection / Exit menu (switch to viewing mode)
	Quick menu	Switch between quick menu options		
DOWN (5) ↓	Regular (observation)	Control continuous digital zoom		PiP on/off
	Menu navigation	Navigation downwards/leftwards		
REC (6) ⊙	Video mode	Start video recording	Pause / resume video recording	Stop video recording / Switch to photo mode
	Photo mode	Take a photograph		

USING THE BATTERY PACK

Thermal imaging sights are supplied with a rechargeable Li-Ion Battery Pack IPS5 which allows operation for up to 8 hours. Please remember to charge the Battery Pack before first use.

Charging:

- Lift the lever **(C)** of the charger.
- Remove the protective cover from the Battery Pack.
- Install the Battery Pack into the charger by inserting the pins **(A)** of the battery into the grooves **(B)** of the charger – the Pulsar logo on the battery Pack should be located closer to the lever; click the lever **(C)** **(Pic.4)**.
- Upon installation, a green **LED** indicator **(D)** on the charger will start to glow and begin flashing:
 - once if the battery charge ranges from 0% to 50%;
 - twice if the battery charge ranges from 51% to 75%;
 - three times if the battery charge ranges from 75% to 100%;
- If the indicator lights green continuously, the battery is fully charged.
- You can remove the battery from the charger by lifting the lever.
- If the indicator of the charger lights **red** continuously upon battery installation, probably the battery's charge level is lower than acceptable (the battery has been long in deep discharge). Keep the battery in the charger for a long time (up to several hours), remove and re-insert it. If the indicator starts blinking **green**, the battery is good; if it keeps lighting **red** it's defective. **Do not use the battery!**
- Connect the Micro-USB plug of the USB cable to the port **(E)** of the charger.
- Connect the Micro-USB plug to the charger.
- Insert the plug of the charger to the 220V socket.

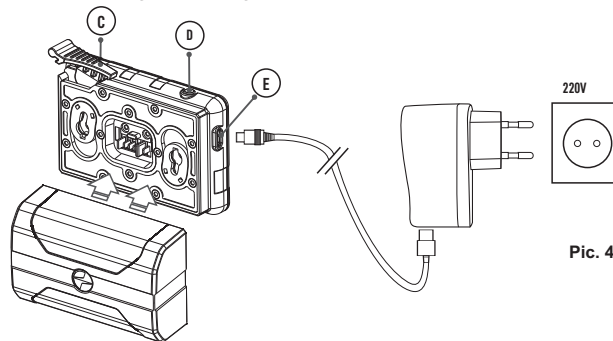

Pic. 4

INSTALLATION:

- Remove the protective cover from the Battery Pack.
- Lift the lever (13).
- Install the battery into the dedicated slot on the sight housing so that element F (Pic.2) appears from below.
- Fix the battery by clicking the lever.

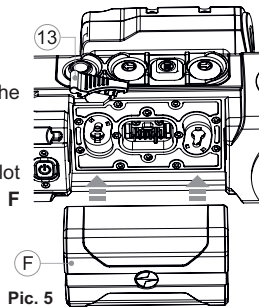

Pic. 5



- Only use the charger supplied with the Battery Pack. The use of any other charger may irreparably damage the Battery Pack or the charger and may cause fire.
- **When keeping the battery for a long period, the battery should not be fully charged or fully discharged.**
- **Do not charge the battery immediately after bringing the battery from cold environment to a warm one. Wait for 30-40 minutes for the battery to get warm.**
- Do not leave a battery unattended while charging. Never use a modified or damaged charger.
- Charge the Battery Pack at a temperature from 0 °C to +45 °C. Otherwise batter's life will decrease significantly.
- Do not leave the Battery Pack with a charger connected to the mains longer than 24 hours after full charge.
- Do not expose the battery pack to high temperature or to a naked flame.
- Do not submerge the battery in water.
- Do not connect external device with a current consumption that exceeds permitted levels.
- The Battery Pack is short circuit protected. However, any situation that may cause short-circuiting should be avoided.
- Do not dismantle or deform the Battery Pack.
- Do not drop or hit the battery.
- When using the battery at negative temperatures, battery's capacity decreases, this is normal and is not a defect.
- Do not use the battery at the temperatures above those shown in the table – this may decrease battery's life.
- Keep the battery out of the reach of children.

7

EXTERNAL POWER SUPPLY

The sight can be powered with an external power supply such as Power Bank (5V).

- Connect the external power supply to the USB port (10) of the sight (Pic. 1).
- The sight switches to operation from external power supply, and the IPS5 Battery Pack will begin slowly charging.

- The display will show the battery icon  with charge level as a percentage.
- If the sight operates on external power supply but the IPS5 battery is not connected, the icon  is shown.
- When the external power supply is disconnected, the sight switches to the internal battery pack without powering off.

8

OPERATION

INSTALLATION OF MOUNT

- Before using the sight you need to install a mount (may not be included).
The mounting holes (14)(pic.4 on the front flyleaf) in the base of the sight enable the mount to be installed in one of the multiple positions. The choice of the mounting position helps the user to ensure the correct eye relief depending on the rifle type.
- Attach the mount to the base of the sight using a hex-nut wrench and screws.
- Install the sight on the rifle and check if the position is suitable for you.
- If you are happy with its position, remove the sight, unscrew the screws halfway, apply some thread sealant onto the thread of the screws and tighten them fully (do not overtighten). Let the sealant dry for a while.
- The sight is ready to be installed on a rifle and to be zeroed.
- After first installation of your sight on a rifle, please follow instructions in the section "Zeroing".

WARNING! Do not point the objective lens of the unit at intensive sources of light such sight emitting laser radiation or the sun. This may render the electronic components inoperative. The warranty does not cover damage caused by improper operation.









Powering on and image setup

- Open the lens cover (1).
- Turn the unit on with a short press of the **ON (11)** button.
- To obtain a crisp image of the icons on the display, rotate the dioptre adjustment ring (7). After this there is no need to rotate the dioptre adjustment ring for distance or any other conditions.
- To focus on the object being observed rotate the lens focusing ring (2).
- To set up display brightness and contrast and continuous zoom, please refer to the QUICK MENU FUNCTIONS section.
- After use, hold down the **ON** button to turn the sight off.

● ZEROING

The sight features two zeroing methods - “one shot” zeroing and using **FREEZE** function.

Zeroing should be done at operating temperatures, by following the order of these steps:

- Mount the rifle with the sight installed on a bench rest.
- Set a target at a certain distance.
- Adjust the sight according to the instructions of section “Powering on and image setup”.
- Select the zeroing profile (see main menu option «Zeroing Profile» ).
- Aim the firearm at the target and take a shot.
- If the point of impact does not match the aiming point (centre of the sight's reticle), hold down the **M (4)** button to enter the main menu.
- Enter the submenu “Zeroing”  with a short press of the **M** button.
- Set the zeroing distance value (see main menu option “Zeroing” => submenu “Add new distance” ).
- Enter the submenu with a short press of the **M** button .
- Select icon  with **UP(3)/DOWN (5)** buttons. Press briefly the **M** button.
- Additional menu for zeroing parameters setup appears on the display .
- An auxiliary cross  appears in the centre of display, and coordinates of the auxiliary cross X and Y appear in the top right corner (**see Pic. 5**).
- Select icon  with **UP/DOWN** buttons. Press briefly the **M** button.
- Holding the reticle in the aiming point, move the auxiliary cross horizontally or vertically with **UP/DOWN** buttons relative to the reticle until the auxiliary cross matches the point of impact.
- **Attention!** Not to hold the reticle in the aiming point, you can use the **FREEZE** function – freezing the zeroing screen (refer to main menu option “Zeroing” => submenu “Distance” => submenu “Zeroing parameters setup” => submenu **FREEZE** ).

- Switch between movement directions of the auxiliary cross from horizontal to vertical with a short press of the **M** button.

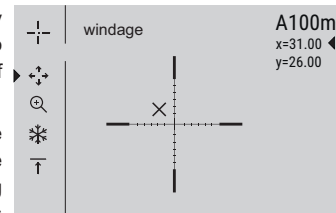

Pic.5

- Save the new position of the reticle with a long press of the **M** button. Message “zeroing coordinates saved” confirms successful operation.
- Menu exit takes place. The reticle will now move to the point of impact.
- Exit the submenu, take another shot - the point of impact should now match the aiming point.

10

● SENSOR CALIBRATION

Calibration allows levelling of the background temperature of the microbolometer and eliminates image flaws (such as frozen image, vertical stripes etc.).

There are three calibration modes: manual (**M**), semi-automatic (**SA**) and automatic (**A**).

Select the desired mode in the menu option “CALIBRATION” .

- **Mode M (manual)**. Close the lens cover, turn the sight on with a short press of the **ON (11)** button. Having finished calibration, open the lens cover.
- **Mode SA (semi-automatic)**. Calibration is activated with a short press of the **ON** button. You do not have to close the lens cover (the sensor is closed with the internal shutter automatically).
- **Mode A (automatic)**. The sight calibrates by itself according to the software algorithm. You do not have to close the lens cover (the sensor is closed with the internal shutter automatically). User assisted calibration with the **ON** button is allowed in this mode (in semi-automatic mode).

11

● DISCRETE DIGITAL ZOOM

The sight allows you to quickly increase the basic magnification (please refer to the “**Digital zoom**” line in the specifications table) by two times or four times (8 times in XP models), as well as to return to the basic magnification. To operate the discrete digital zoom, press successively the **DOWN (5)** button.

QUICK MENU FUNCTIONS

The Quick menu allows change of basic settings (display brightness and contrast, incremental digital zoom, information on the actual profile and zeroing distance).

- Enter the menu with a short press of the **M (4)** button.
- To toggle between the functions below, press successively the **M** button.
- **Brightness** ☀️ – press the **UP (3)** and **DOWN (5)** buttons to change display brightness from 00 to 20.
- **Contrast** 🗨️ – press the **UP/ DOWN** buttons to change display contrast from 00 to 20.
- **Digital zoom** 🔍 – press the **UP/ DOWN** buttons to change digital zoom from 1.0x to 4.0x (or 8.0x in XP models). Continuous digital zoom is in 0.1x increments.
- The initial value of the continuous digital zoom is x1.0 if the discrete digital zoom is not active; x2.0 is discrete digital zoom is 2x; x4.0 is discrete digital zoom is 4x; x8.0 is discrete digital zoom is 8x.

Notes.

- actual magnification is the product of the basic magnification value and continuous digital zoom value. For example: the sight's basic magnification is 2.1x, continuous digital zoom value x1.7. Actual magnification is 3,6x (2,1*1,7).

- display brightness and contrast settings are saved in the memory when the unit is turned off.

- A100 T – information on the actual profile and zeroing distance, at which zeroing was done in this profile (for example, profile A, zeroing distance 100m).
Toggle between zeroing distances with the **UP (3)** and **DOWN (5)** buttons.

MAIN MENU FUNCTIONS

- Enter the main menu with a long press of the **M (4)** button.
- Press the **UP (3)** and **DOWN (5)** buttons to toggle between the main menu options.
- Main menu navigation is cyclical: as soon as the last menu option of the first tab is reached, first menu option of the second tab starts.
- Enter a submenu of the main menu with a short press of the **M** button.
- Exit the submenu with a long press of the **M** button.
- Automatic exit takes place in 10 sec of inactivity.

- Upon exit from the menu the cursor location ▶ is memorized only for the duration of the working session (i.e. until the unit is turned off). Upon restarting the sight and entering the menu the cursor will be located on the first menu option.

MENU CONTENTS:



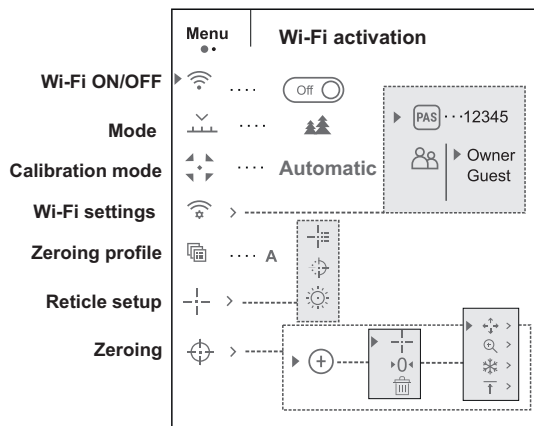

Tab 1

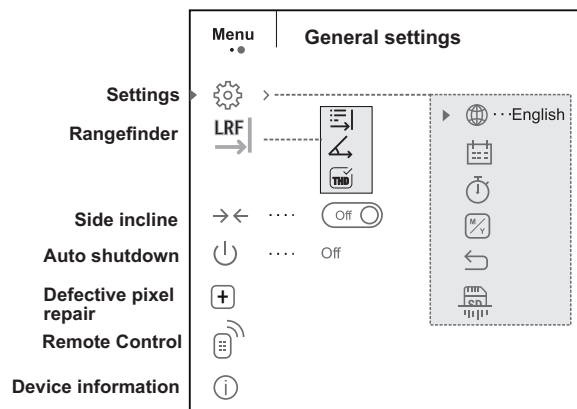





Tab 2



Menu contents and description

 Wi-Fi	Wi-Fi ON/OFF
▶  ... 	Turn Wi-Fi on with a short press of the M (4) button.
▶  ... 	Turn Wi-Fi off with a short press of the M (4) button.

 Mode	Selection of operating mode.
	There are three automatic operating modes: Each mode includes optimal combination of parameters (brightness, contrast, gain etc.) to deliver best possible image in specific viewing conditions.
 Rocks	Enhanced contrast mode. Perfect for viewing animals against the background of rocks, ground in mountain areas.
 Forest	Low contrast mode Perfect for viewing animals against a background of vegetation.
 Identification	Universal mode for various modes of observation.

 Calibration	Selection of calibration mode. There are three calibration modes: manual (M), semi-automatic (SA) and automatic (A).
	<ul style="list-style-type: none">• Enter the main menu with a long press of the M (4) button.• Enter the submenu with a short press of the M button.• Select one of the below calibration modes with UP (3) and DOWN (5) buttons.• Confirm selection with a short press of the M button.
A	Automatic. In the automatic mode the need for calibration is based on software algorithm. Calibration starts automatically.
SA	Semi-automatic. The user determines for himself the need for calibration based on the actual image status.
M	Manual (silent) calibration. Close the lens cover before calibration.

Wi-Fi settings

Wi-Fi setup.

This menu option allows you to set up your sight for operation in a Wi-Fi network.

Password setup

This submenu allows you to set a password to access your thermal sight from an external sight.

- ▶  ... 12345
- The password is used to connect an external sight (i.e. smartphone) to your thermal sight.

- Enter the main menu with a long press of the **M (4)** button.
- Enter the submenu "Wi-Fi" with a short press of the **M** button.
- The default password "12345" appears on the display.
- Set the desired password with the **UP (3)** and **DOWN (5)** buttons (button UP to increase value; button DOWN to reduce). Switch between digits with a short press of the M button.

Save the password and exit the submenu with a long press of the **M** button.

Access level setup

This submenu allows you to set required access level of the Stream Vision application to your sight.

- ▶  ▶ Owner
Guest
- Access level **Owner**. The Stream Vision user has the complete access to all sight's functions.
 - Access level **Guest**. The Stream Vision user has the access only to the real time video stream from the sight.

- Enter the main menu with a long press of the **M (4)** button.
- Enter the submenu with a short press of the **M** button.
- Set the desired access level with the **UP (3)** and **DOWN (5)** buttons.
- Save your selection and exit the submenu with a long press of the **M** button.



Zeroing profile

This main menu option allows you to select between one of the three profiles. Each profile includes the following:

- 1) Set of distances with zeroing coordinates for each.
- 2) Reticle color
- 3) Reticle type

Various profiles can be used when employing the sight on different rifles and when shooting different cartridges.

- Enter the main menu with a long press of the **M (4)** button.
- Enter the submenu “Zeroing profile” with a short press of the **M** button.
- Select one of the zeroing profiles (shown with letters A; B; C) with the **UP (3)** and **DOWN (5)** buttons.
- Confirm your selection with a short press of the **M** button.
- The name of a selected profile is displayed in the status bar.



Reticle setup



Reticle type

This main menu option allows you to select reticle shape, color and brightness.

Selection of reticle shapes.

- Enter the main menu with a long press of the **M (4)** button.
- Enter the submenu “Reticle type” with a short press of the **M** button.
- Select the desired reticle shape out of the list of 13 reticles with **UP (3)** and **DOWN (5)** buttons.
- The reticle types change as the cursor goes down the reticle list.
- Confirm your selection with a short press of the **M** button.



Reticle color

Selection of reticle color

- Enter the main menu with a long press of the **M (4)** button.
- Enter the submenu “Reticle color” with a short press of the **M** button.
- Select the desired reticle color: black or white - with **UP (3)** and **DOWN (5)** buttons.
- Confirm your selection with a short press of the **M** button.



Reticle brightness



Reticle brightness setup

- Enter the main menu with a long press of the **M (4)** button.
- Enter the submenu “Reticle brightness” with a short press of the **M** button.
- Set the desired reticle brightness from 0 to 10 with **UP (3)** and **DOWN (5)** buttons.
- Confirm your selection with a short press of the **M** button.







Zeroing



Adding new distance:



To zero your rifle, you need to set a zeroing distance first.

You can zero your weapon at any distance ranging from 1 to 910m (1 to 955 yards).

- Enter the main menu with a long press of the **M (4)** button.
- Select main menu option  and enter it with a short press of the **M** button.
- Enter the submenu “Add new distance”  with a short press of the **M** button.
- Set the values for each digit with the **UP (3)** and **DOWN (5)** buttons. Switch between the digits with a short press of the **M** button.  150m
- Having set the desired distance, hold down the **M** button to save it.
- The distance you set first becomes a primary distance – shown with icon  on the right to the distance value.

Note: max. number of zeroing distances is 10 for each profile.



Operating the distances:

- Enter the main menu with a long press of the **M (4)** button.
- Select main menu option  and enter it with a short press of the **M** button.
- Enter the submenu operating the distances  and enter it with a short press of the **M** button – distances at which zeroing has been done will be shown.

▶ 300m ... +7.0
 600m ... ▶ 0 ◀
 ⊕

- The values (for example, +7.0) shown on the right of the distance values, stand for the number of clicks along the Y axis, at which the reticle position at other distances differs from the reticle position in the primary distance.
- To re-zero at any distance, select the desired distance and press briefly the **M** button.
- Zeroing screen which allows the change of zeroing coordinates will appear.

Changing the primary distance.

- Select a non-primary distance and enter the submenu for operating the distances with a short press of the **M** button.
- Select icon  - primary distance.
- Press briefly the **M** button.
- Icon  next to the selected distance confirms the change of primary distance.

Deleting added distance.

- Select the distance you wish to delete and enter the submenu for operating the distances with a short press of the **M** button.
- Select icon  "delete distance".
- Select "Yes" in the dialog box to delete a distance. "No" – to cancel deletion.
- When selecting "Yes" you go to the submenu "list of distances"; "No" – return to the previous screen "operating the distances".

Attention! If the primary distance is deleted, the first distance on the list automatically becomes the new primary distance.

Additional menu for zeroing parameters setup

Having selected a zeroing distance and having entered the submenu , the display shows the following:



- Windage/Elevation correction
- Magnification
- Zeroing with the FREEZE function
- Edit distance title

Additional menu option "Windage/Elevation correction" allows you to correct the reticle position as follows:

- First select in the submenu "Operating the distances" at which the reticle position needs to be corrected.

- Select icon  with a short press of the **M** button.
- For detailed description of the reticle position correction please refer to section 9 "Zeroing".



Magnification

This submenu allows you to increase the sight's digital zoom when zeroing which reduced the click value this improving accuracy of zeroing.

- Having selected a zeroing distance and having entered the submenu, select submenu "Magnification" with a short press of the **M** button.
- Select the digital zoom value (i.e. 4x) with the **UP (3) and DOWN (5)** buttons.
- Confirm you selection with a short press of the **M** button.



Freeze

Function FREEZE is designed to zero your weapon.

The highlight of the function is that, unlike in the "one shot zeroing" method, you **do not need to hold the sight in the aiming point**.

- Having selected a zeroing distance and having entered the submenu, enter the submenu FREEZE with a short press of the **M** button or press briefly the **ON** button when in the zeroing mode.
- A screen shot (image freezing) will be made – icon  will appear on the display.
- For detailed description of the zeroing procedure, please refer to section 9 "Zeroing".



Edit distance title.

This submenu allows you to change the value of the current distance.

- Having selected a zeroing distance and having entered the submenu, enter the submenu "Edit distance title" with a short press of the **M** button.
- Select values for each digit with the **UP (3) and DOWN (5)** buttons. Toggle between the digits with a short press of the **M** button.
- Confirm you selection with a long press of the **M** button.



Settings

The following settings are available:

Language

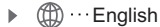

Interface language selection

- Enter the main menu with a long press of the **M (4)** button.
- Enter the submenu "Settings" with a short press of the **M** button.
- Enter the submenu "Language" with a short press of the **M** button.
- Select one of the available interface languages with a short press of the **UP (3) and DOWN (5)** buttons: English, French, German, Spanish.
- Switch between languages with a short press of the **M** button.
- Save selection and exit the submenu with a long press of the **M** button.



Date

Date setup

- Enter the main menu with a long press of the **M (4)** button.
- Enter the submenu "**Settings**" with a short press of the **M** button.
- Enter the submenu "**Date**" with a short press of the **M** button. Date format is displayed as: **YYYY/MM/DD (2018/01/24)**.
- Select the correct values for the year, month and date with a short press of the **UP (3) and DOWN (5)** buttons.
- Switch between digits with a short press of the **M** button.
- Save selected date and exit the submenu with a long press of the **M** button.



Time

Time setup

- Enter the main menu with a long press of the **M (4)** button.
- Enter the submenu "Settings" with a short press of the **M** button.
- Enter the submenu "Time" with a short press of the **M** button.
- Select the desired time format with a short press of the **UP and DOWN** buttons: **24 or PM/AM**.
- Switch to hour setup with a short press of the **M** button.
- Select hour value with a short press of the **UP and DOWN** buttons.

- Switch to minute setup with a short press of the **M** button.
- Select minute value with a short press of the **UP and DOWN** buttons.
- Save selected date and exit the submenu with a long press of the **M** button.

Units of measure



Selection of units of measurement

- Enter the main menu with a long press of the **M (4)** button.
- Enter the submenu "Settings" with a short press of the **M** button.
- Enter the submenu "Units of measure" with a short press of the **M** button.
- Select the desired time format with a short press of the **UP/ DOWN** buttons, press **M** again.
- Menu exit will take place automatically.



Reset

Restore default settings

- Enter the main menu with a long press of the **M (4)** button.
- Enter the submenu "Settings" with a short press of the **M** button.

Enter the submenu "Reset" with a short press of the **M** button.

- With a short press of the **UP and DOWN** buttons select "Yes" to restore default settings or "No" to abort.
- Confirm selection with a short press of the **M** button.
- If "Yes" is selected, display will show "Return default settings?" and "Yes" and "No" options. Select "Yes" to restore default settings.
- If "No" is selected, action is aborted and you return to the submenu.

The following settings will be restored to their original values before changes made by the user:

- Operating mode of video recorder – video
- Operating mode of the sight - forest
- Calibration mode – automatic
- Zeroing profile - A
- Reticle selection – 1*
- Reticle color – black*
- Reticle brightness – 5*
- Language – English
- "TPA" – off
- Rangefinder's indicator – 1
- "THD" – off
- Wi-Fi – off (default password)
- Digital zoom - off
- Colour palette – White Hot
- Unit of measurement - metric
- PiP – off
- Side incline – off
- Auto shutdown – off

* These values are set for all profiles (A, B and C).

Warning: date and time settings, default pixel map and remote control activation, zeroing coordinates for all distances are not restored.



Format

This menu option allows you to format your sight's Flash card or memory card (erase all files from its memory).

- Enter the main menu with a long press of the **M (4)** button.
- Enter the submenu "Settings" with a short press of the **M** button.
- Enter the submenu "Format" with a short press of the **M** button.
- With a short press of the **UP and DOWN** buttons select "Yes" to format the memory card or "No" to return to the submenu.
- Confirm selection with a short press of the **M** button.
- If "Yes" is selected, display will show "Do you want to format memory card?" and "Yes" and "No" options. Select "Yes" to format the memory card.
- Message «Memory card formatting» means that formatting is in progress.
- Upon completion of formatting the message «Formatting completed» is shown.
- If "No" is selected, formatting is aborted and you return to the submenu.

LRF | Rangefinder



Menu item "Rangefinder" allows you to set up built-in rangefinder's parameters as follows:

- Enter the main menu with a long press of the **M (4)** button.
- Enter the submenu "Rangefinder" with a short press of the **M** button.
- Set the desired parameter with the **UP (3)** and **DOWN (5)** buttons.

☰ | Selection of rangefinding indicator

- Select one of the three indicator shapes with the **UP (3)** and **DOWN (5)** buttons.
- Confirm selection with a brief press of the **M (4)** button.
- Upon start the aiming reticle disappears from the display, and rangefinding indicator is only shown instead.
- In 4 seconds of inactivity the aiming reticle reappears on the display.



↙ | Function "Target position angle" (TPA)

- Function "**TPA**" allows you to change angle of target location (angle of elevation). When the function is activated, the angle is shown continuously. When the function is disabled, the angle is shown if the rangefinder is working. The angle is shown in a pop-up menu during measurement.
- Select **(On)** to activate "TPA".
- Confirm selection with a brief press of the **M (4)** button.



THD" function

"THD" function allows the user to measure true horizontal distance to a target based on the angle of elevation value.

- Select **(On)** to activate "THD".
- Confirm selection with a brief press of the **M (4)** button. Hereinafter message THD will appear above the distance readings.



This option allows you to activate/deactivate the side (horizontal) incline of the rifle.

Side incline

Side incline is indicated by "sector" arrows on the edges of the horizontal line of the reticle. Arrows show the direction in which you should move your rifle to eliminate side incline.



There are three modes of side incline:

- 5°-10° - one sector arrow;
- 10°-20° - two sector arrow;
- >20° - three sector arrow.

A side incline of less than 5° is not shown on the display.

- Enter the main menu with a long press of the **M (4)** button.
- Enter the submenu "Side incline" with a short press of the **M** button.
- Select "On" with the **UP (3) and DOWN (5)** buttons to activate side incline; «Off» to deactivate.
- Confirm your selection with a short press of the **M** button.



Auto shutdown

This option allows you to activate automatic shutdown the sight which recognizes whether your sight is in a shooting position. Automatic shutdown is actuated after you move the sight relative to the optical axis:

Upwards >70°; Downwards >70°; Leftwards >30°; Rightwards >30°



- Enter the main menu with a long press of the **M (4)** button.
- Enter the submenu "Auto shutdown" with a short press of the **M** button.
- With the **UP (3)** and **DOWN (5)** buttons select the time period (1 min, 3 min, 5 min) upon expiry of which the sight will automatically shut down. Select "Off" if you wish to deactivate Auto shutdown.
- Confirm your selection with a short press of the **M** button.

Note: if Auto shutdown is active, the status bar shows the respective icon and selected time period 1min.



Defective pixel repair

When operating a thermal sight, defective (dead) pixels (bright or dark dots with constant brightness) may become visible on the sensor. Thermal sights allow the user to repair defective pixels on the detector using a software-based method or to abort deletion.

- Enter the main menu with a long press of the **M (4)** button.
- Enter the submenu "Defective pixel repair" with a short press of the **M** button.
- Select icon  with a short press of the **M** button.
- A marker  appears on the left side of the display.
- On the right side of the display appears a "magnifying glass" (G) – a magnified image in a frame with a fixed cross (H),  designed for easier detection of a defective pixel and to match the pixel with the marker, horizontal and vertical arrows for X and Y axes (I) showing marker's movement.
- With a short press of the **UP and DOWN** buttons move the marker to align it with a defective pixel.
- Switch the direction of the marker from horizontal to vertical and vice versa with a short press of the **M** button.
- Align the defective pixel with the fixed cross in the frame – the pixel should disappear.
- Delete the defective pixel with a short press of the **REC (6)** button.
- A brief message "**OK**" appears in the frame in case of success.
- Then you can delete another defective pixel by moving the marker along the display.
- Exit "**Defective pixel repair**" option with a long press of the **M** button.

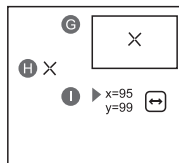



Return to default defective pixel pattern

This option allows you to cancel deletion of the defective pixels and return them to the original state.

- Enter the main menu with a long press of the **M (4)** button.
- Enter the submenu "Defective pixel repair" with a short press of the **M** button.
- Select icon  and press **M**.
- Select "Yes" if you wish to return to default defective pixel pattern, or "No" if you do not.
- Confirm selection with a short press of the **M** button.

Remote Control

Before operating the remote control, remember to activate it as follows:

- Enter the main menu with a long press of the **M (4)** button.
- Enter the submenu "Settings" with a short press of the **M** button.
- Enter the submenu "Remote control" with a short press of the **M** button.
- Press the **M** button, countdown starts (30 sec), within which hold down for two seconds any RC button.
- If activation is successful, the message «Connection complete» appears.  If error occurs the message «Connection failed»  appears. Repeat the procedure.
The RC is activated and ready for use.

Unlinking remote control:

- Enter the main menu, select menu item "Remote control".
- Press the **M** button, countdown will start (30 sec).
- Wait for the countdown to expire without pressing any RC button for 30 sec.
- All remote controls previously linked to your sight are now unlinked.

Info

This option allows the user to view the following information about the sight:

- Full name
- SKU number
- serial number
- software version
- hardware version
- service information

Enter the main menu with a long press of the **M (4)** button.

Enter the submenu "Info" with a short press of the **M** button.

14

STATUS BAR

The status bar is located in the lower part of the display and shows information on the actual operating status of the sight, including:



(1) Image inversion mode (only Hot Black)

(2) Actual zeroing profile (for example A)

(3) Zeroing distance (for example, 300 m)

(4) Operating mode (for example, Forest)

(5) Calibration mode

in the automatic calibration mode, three seconds before automatic calibration a countdown timer  00:01 is shown in place of the calibration mode icon)

(6) Current full magnification (for example x12.8)

(7) Wi-Fi connection status

(8) Function "Auto shutdown" (for example 1 min)

(9) Running time

(10) Battery charge level (if the sight is powered by the Battery Pack) or External battery power indicator  (if the sight is powered by an external power supply)

BUILT-IN LASER RANGEFINDER

The sight is equipped with a built-in rangefinder (9), allowing you to measure distance to objects up to 1000m away.

How the rangefinder works:

- Turn on the sight, adjust image according to section 8 “**Operation**”, press the “**UP**” (3) or **REC** (17) button on remote control – rangefinding indicator appears (and aiming reticle disappears), in the top right corner of the display dashes of distance values with unit of measurement appear, i.e. the rangefinder enters the stand-by mode.
- If PIP mode is activated, the aiming reticle disappears upon activation of the rangefinder and the PIP window remains active.
- Point the rangefinding indicator at an object and press the “**UP**” button.
- In the top right corner of the display you will see distance in metres (or yards – depending on settings). 
- **Note:** if the rangefinder is idle longer than for three seconds, it turns off automatically and aiming reticle appears.

Operation in SCAN mode:

- To measure distance in scanning mode, hold down the “**UP**” button or **REC** (17) button on remote control for longer than two seconds. Measurement readings will be changing in real time as you point the sight at different objects. In top right corner message **SCAN** appears. To exit **SCAN** mode, press “**UP**” again.
- In case of unsuccessful measurement dashes will appear on the display.
- To exit **SCAN** mode and to return to regular measurement mode, press “**UP**”.

Примечания:

- To select a rangefinding indicator, please go to the respective menu option. 
- To select a unit of measurement (metres or yards) go to “**Settings**”.

Peculiarities of operation

- Accuracy of measurement and maximum range depend on the reflection ratio of the target surface, the angle at which the emitting beam falls on the target surface and environmental conditions. Reflectivity is also affected by surface texture, colour, size and shape of
- Measuring range to a small sized target is more difficult than to a large sized target.
- Accuracy of measurement can also be affected by light conditions, fog, haze, rain, snow etc. Ranging performance can degrade in bright conditions or when ranging towards the sun.

VIDEO RECORDING AND PHOTOGRAPHY

TRAIL LRF thermal sights feature video recording and photography of the image being ranged to the internal memory card.

Before using this feature please read the menu options “**Date setup**”, “**Time setup**” of the section “**Main menu functions**”.

The built-in recorder operates in two modes - **VIDEO** and **PHOTO**

VIDEO mode. Video recording





- The device in the VIDEO mode upon turning on.
- In the top left corner you will see icon  and remaining recording time in the format HH:MM (hours: minutes) 5:12.
- Start video recording with a short press of the **REC** (6) button.
- Upon start of video recording icon  disappears, and icon **REC** and recording timer in the format MM:SS (minutes : seconds) appear instead: 
- Pause and resume recording video with a short press of the **REC** button.
- Stop recording video with a long press of the **REC** button.
- Video files are saved to the memory card after stopping video.
- Switch between modes (Video-> Photo-> Video) with a long press of the **REC** button.

Photo mode. Photography

- Switch to the Photo mode with a long press of the **REC** button.
- Take a picture with a short press of the **REC** button. The image freezes for 0.5 sec and a photo is saved to the internal memory. in the top left corner of the display you can see: photography icon , “>100” means that you can take more than 100 pictures. If the number of available pictures is less than 100, actual amount of available pictures (for example 98) is shown next to the icon .

Notes:

- you can enter and operate the menu during video recording;
- recorded videos and photos are saved to the built-in memory card in the format **img_xxx.jpg (photos); video_xxx.avi (videos)**. **xxx** – three-digit counter for videos and photos;
- counter for multimedia files cannot be reset;

Attention!

- **Maximum duration of a recorded file is seven minutes. After this time expires a video is recorded into a new file. The number of recorded files is limited by the capacity of unit's internal memory.**

- check regularly the free capacity of the internal memory, move recorded footage to other storage media to free up space on the internal memory card;

IMPORTANT!

To playback video files recorded by thermal imaging devices on iOS-based computers, we recommend that you use **VLC** video player or **Elmedia player**.

Download links and QR codes are shown below:



VLC VIDEO PLAYER
<http://www.videolan.org/vlc/download-macosx.html>



ELMEDIA VIDEO PLAYER
<https://itunes.apple.com/us/app/elmedia-multiformat-video/id937759555?mt=12>



Recoil activated video recording

- When operating in this mode, the sight starts video recording upon taking a shot.
- To activate this mode, press and hold down the REC button until recording icon  and bullet icon  appear in the upper left corner.
- Upon taking a shot, video recording is activated automatically - 10 seconds before the shot and up to 3 minutes after.

During recording you can:

- **Continue recording** for a period of more than 3 min – briefly press the REC button.
- **Pause a video** – briefly press twice the REC button.

Stop recording – press and hold down the REC button.

Notes:

If one or multiple shots are taken during recording, recording time will prolong – the last shot taken adds another three minutes.





When recording a video in the mode "Recoil activated video recording", you can use all functions available in the "Video" mode.



17

WI-FI FUNCTION

Your thermal sight features wireless connection option (Wi-Fi) which links it with external appliances (tablet, smartphone).

- Turn on the wireless module the with a long press of the **UP (3)** button. Wi-Fi operation is shown in the status bar as follows:

Connection status	Status bar indication
Wi-Fi is off	
Wi-Fi activated by the user, Wi-Fi in the sight is being activated	
Wi-Fi is on, no connection with sight	
Wi-Fi is on, sight connected	

- Your sight is detected by an external sight as “**TRAIL_LRF XXXX**”, where **XXXX** – is the last four digits of sight's serial number».
- After a password is generated on an external appliance (please refer to the menu option “Wi-Fi setup” of the section “Main menu functions” of this user manual) and connection is established, the icon  in the status bar changes to 

18

FUNCTION DISPLAY OFF

The DISPLAY OFF function deactivates transmission of image to the display by minimizing its brightness. This prevents accidental disclosure. The device keeps running.

- When the device is on, hold down the **ON (1)** button. Display goes out, message “**Display off**”.
- To activate the display, press briefly the **ON** button.
- When holding down the **ON** button, the display shows “**Display off**” message with countdown, the device will turn off.



19

FUNCTION PiP

PIP (“Picture in Picture”) allows you to see a zoomed image simultaneously with the main image in a dedicated window.

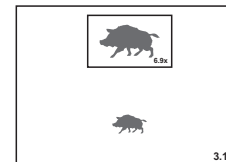

- Turn on/off the **PIP** function with a long press of the **DOWN (8)** button.
- Change zoom ratio in the **PIP** window with a short press of the **DOWN** button.
- The zoomed image is displayed in a dedicated window, with the full optical magnification being shown.
- The main image is shown with optical magnification ratio which corresponds to ratio x1.0.
- When **PIP** is turned on, you can operate the discrete and continuous digital zoom. The full optical magnification will take place only in the dedicated window.
- When **PIP** is turned off, the image is shown with the optical magnification set for the **PIP** function.

SCALABLE RETICLE

- This function is designed to preserve ballistic properties of the M56Fi reticle for all magnifications.
 - Enter the main menu, select menu item “Reticle setup”.
 - Enter menu item “Reticle type”, select Mil-Dot reticle M56Fi.
 - When zooming in and out the image, the selected reticle on the display and in the recorded video changes its geometrical size according to the magnification selected.
 - The reticle scale changes both on the main display and in the PiP mode.
- To learn more about the Mil-Dot reticle M56Fi, please go online www.pulsar-nv.com

SHOT COUNTER

- Trail sight is equipped with a sensor which counts shots taken with your rifle.
- Enter the main menu, select menu item “About”.
- Press the M button - line “Shots” will show the number of shots taken with a rifle with a Trail sight installed.

Notes:

- The shot counter is always active when the sight is on.
- The shot counter cannot be reset or deactivated.

STREAM VISION

TRAIL thermal sights support Stream Vision technology which allows you to stream an image from the display of your thermal sight to a smartphone or PC tablet via Wi-Fi in real time mode.

Further guidelines are available online: www.pulsar-nv.com

Note: the Stream Vision application allows you to update the firmware features of your thermal sight.

Scan the QR codes to download Stream Vision free of charge:



Google Play (Android OS):



iTunes (iOS):

USB CONNECTION

- Connect one end of the USB cable to the Micro-USB (10) port of your sight, and the other end to the USB port of your PC/laptop.
- Turn the sight on with a short press of the **ON (11)** button (sight that has been turned off cannot be detected by your computer).
- Your sight will be detected by the computer automatically; no drivers need to be installed.
- Two connection modes will appear on the display:
 - Memory card** (external memory) and **Power**.
- Select connection mode with **UP and DOWN** buttons.
- Confirm selection with a short press of the **M** button.

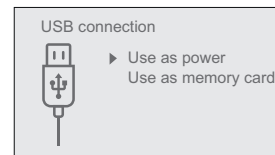

Connection modes:

- **Memory card (external memory).** In this mode the device is detected by the computer as a flash card. This mode is designed for work with the files saved in device's memory. The device's functions are not available in this mode; the device turns off automatically.
 - If video recording was in progress when connection was made, recording stops and video is saved.
- When **USB** is disconnected from the device where connection is in the **USB** Mass storage device mode, the device remains on the **OFF** state. Turn the device **ON** for further operation.

Power.

- In this mode PC/laptop is used as an external power supply. The status bar shows icon . The device continues operating and all functions are available.
 - Note:** The Battery pack installed in the device is not being charged!
- When **USB** is disconnected from the device when in the Power mode, the device keeps operating with Battery Pack, if available, and it has sufficient charge.

WIRELESS REMOTE CONTROL

Wireless remote control (RC) duplicates the POWER ON function, digital zoom, distance measurement, and menu navigation.

RC controls are:

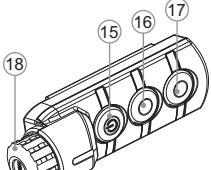
	Controller (18)	Button ON (15)	Button ZOOM (16)	Button REC (17)
Short press	Enter quick menu	Turn sight on / Calibrate sensor	Activate incremental zoom	Measure distance
Long press	Enter main menu	Turn display / sight off	Turn on/off PiP	Wi-Fi on/off SCAN mode
Clockwise rotation	Increase value, upward movement			
Counter-clockwise rotation	Decrease value, downward movement			

MAINTENANCE AND STORAGE

Maintenance should be carried out no less frequently than twice a year, and should consist of the following measures:

- Wipe external plastic and metal surfaces clean of dust and dirt with a soft cloth moistened with a synthetic cleaning agent.
- Clean the electric terminals of the Battery Pack and sight's battery slot using a grease-free organic solvent.
- Check the objective and eyepiece lenses. If required, remove dust and sand (preferably by a noncontact method). Clean the external surfaces of the lenses with products expressly designed for this purpose.
- Always store the sight in its carrying case in a dry, well-ventilated space. For prolonged storage, remove the batteries.

TECHNICAL INSPECTION

Check:

- External view (there should be no cracks on the housing).
- The state of the objective and eyepiece lenses (there should be no cracks, spot, dust, deposits etc.).
- The state of the Battery Pack (should be charged) and electric terminals (there should be no oxidation).
- Correct functioning of the controls.

TROUBLESHOOTING

The table presented below lists some potential problems that may occur when using the sight. If a problem encountered with the sight is not listed, or if the recommended action does not resolve the problem, the unit should be returned for repair.

Problem	Check	Corrective action
The thermal sight will not turn on.	Battery Pack is discharged.	Charge the battery.
The sight does not operate on external power supply.	USB cable is damaged.	Replace USB cable.
	External power supply is discharged.	Charge the external power supply (if necessary).
The image is blurry, with vertical stripes and uneven background.	Calibration is required.	Carry out calibration according to Section "SENSOR CALIBRATION".
The image is too dark.	Brightness or contrast level is too low.	Adjust brightness/contrast with the UP/DOWN buttons.
The reticle is blurred and cannot be focused with the dioptre knob.	The dioptre cannot be adjusted to your eyesight.	If you wear prescription glasses with a range of +/- 4, keep glasses on when looking through the eyepiece.

Problem	Check	Corrective action
With a crisp image of the reticle, the image of the observed target that is at least 30 m away is blurred.	Dust and condensate are covering the outside optical surfaces after the sight was brought in from the cold into a warm environment, for example. The objective lens is not focused.	Clean the lens surfaces with a blower and soft lens cloth. Let the sight dry by leaving it in a warm environment for 4 hours. Adjust the image by rotating the lens.
The aiming point shifts after firing rounds.	The sight is not mounted securely or the mount was not fixed with thread sealant.	Check that the sight has been securely mounted, make sure that the same type and calibre bullets are being used as when the scope was initially zeroed; if your sight was zeroed during the summer, and is now being used in the winter (or the other way round), a small displacement of the aiming point is possible.
The sight will not focus.	Wrong settings.	Adjust the sight according to the instructions given in the Section 8 "OPERATION" and check the surfaces of the eyepiece and objective lenses and clean them if necessary from dust, condensation, frost, etc; to prevent fogging in cold weather, apply a special anti-fog solution.
The sight cannot be powered on with wireless remote control.	Remote control is not activated. Low battery.	Activate the remote control according to instructions. Install a new CR2032 battery.
Smartphone or tablet PC cannot be connected to the sight.	Password in the unit was changed. There are too many Wi-Fi networks in the area where the sight is located which may cause signal interference.	Delete network and connect again inserting the password saved in the sight. To ensure stable Wi-Fi performance, move the sight to an area with few or no Wi-Fi networks.
No Wi-Fi signal or erratic signal.	The unit is beyond reliable Wi-Fi range. There are obstacles between the device and the signal receiver (i.e. concrete walls).	Place the device in line-of-sight of the Wi-Fi signal.

Problem	Check	Corrective action
There is no image of the object under observation.	You are looking through glass.	Remove glass from the field of view.
Poor image quality / Detection range reduced.	Problems described may arise in adverse weather conditions (snow, rain, fog etc.).	
When using the scope at below zero temperatures the image quality is worse than at positive temperatures.	Because of variations in thermal conductivity, objects (surrounding environment, background) under observation become warm more quickly at above-zero temperatures, which allows higher temperature contrast and, thus, the quality of the image produced by a thermal imager will be better. At low operating temperatures, objects under observation (background) normally cool down to roughly identical temperatures, which leads to lower temperature contrast, and to image quality (precision) degradation. This is normal for thermal imaging device.	
Rangefinder does not measure distance.	In front of the receiver lens or emitter lens there is an object that prevents signal The unit is not held steadily when measuring. Distance to the object exceeds 1000m. Low reflection ratio (i.e. leaves of trees).	Make sure that: the lenses are not blocked by your hand or fingers; the lenses Do not stress the unit when measuring. Choose an object at a distance longer than 1000m. Choose an object with a higher reflection ratio.
Large measurement error.	Incliment weather conditions (rain, mist, snow).	

Follow the link to read FAQs on thermal vision <http://www.pulsar-nv.com/support/faq/>

Attention! The display of a thermal sight may have 1-2 pixels represented as bright white or color (blue, red) dots which cannot be deleted and are not a defect. The defective pixels on the sensor may proportionally increase in size when digital zoom is activated.