



IMAGETEAM™ 3800/3900

Hand Held Linear Imager

User's Guide



Disclaimer

Hand Held Products, Inc. d/b/a HHP (“HHP”) reserves the right to make changes in specifications and other information contained in this document without prior notice, and the reader should in all cases consult HHP to determine whether any such changes have been made. The information in this publication does not represent a commitment on the part of HHP.

HHP shall not be liable for technical or editorial errors or omissions contained herein; nor for incidental or consequential damages resulting from the furnishing, performance, or use of this material.

This document contains proprietary information which is protected by copyright. All rights are reserved. No part of this document may be photocopied, reproduced, or translated into another language without the prior written consent of HHP.

© 2000-2002 **Hand Held Products, Inc.** All rights reserved.

Web Address: www.HHP.com

Statement of Agency Compliance

This device complies with part 15 of the FCC Rules. Operation is subject to the following two conditions: (1) this device may not cause harmful interference, and (2) this device must accept any interference received, including interference that may cause undesired operation.

FCC Class B Compliance Statement

This equipment has been tested and found to comply with the limits for a Class B digital device pursuant to part 15 of the FCC Rules. These limits are designed to provide reasonable protection against harmful interference in a residential installation. This equipment generates, uses, and can radiate radio frequency energy and, if not installed and used in accordance with the instructions, may cause harmful interference to radio communications. However, there is no guarantee that interference will not occur in a particular installation. If this equipment does cause harmful interference to radio or television reception, which can be determined by turning the equipment off and on, the user is encouraged to try to correct the interference by one or more of the following measures:

- Reorient or relocate the receiving antenna.
- Increase the separation between the equipment and receiver.
- Connect the equipment into an outlet on a circuit different from that to which the receiver is connected.
- Consult the dealer or an experienced radio or television technician for help.

Caution: Any changes or modifications made to this device that are not expressly approved by Hand Held Products, Inc. may void the user's authority to operate the equipment.

Note: To maintain compliance with FCC Rules and Regulations, cables connected to this device must be shielded cables, in which the cable shield wire(s) have been grounded (tied) to the connector shell.

Canadian Notice

This equipment does not exceed the Class B limits for radio noise emissions as described in the Radio Interference Regulations of the Canadian Department of Communications.

Le présent appareil numérique n'émet pas de bruits radioélectriques dépassant les limites applicables aux appareils numériques de la classe B prescrites dans le Règlement sur le brouillage radioélectrique édicté par le ministère des Communications du Canada.



The CE mark on the product indicates that the system has been tested to and conforms with the provisions noted within the 89/336/EEC Electromagnetic Compatibility Directive and the 73/23/EEC Low Voltage Directive.

For further information please contact:
Hand Held Products, Inc.
Nijverheidsweg 9
5627 BT Eindhoven
The Netherlands

HHP shall not be liable for use of our product with equipment (i.e., power supplies, personal computers, etc.) that is not CE marked and does not comply with the Low Voltage Directive.

UL and cUL Statement

UL listed UL1950 and CSA 22.2 No.950. cUL listed UL1950 and CSA 22.2 No 950.

LED Safety Statement

This device has been tested in accordance with EN60825-1 LED safety, and has been certified to be under the limits of a Class 1 LED device.

TÜV Statement

TÜV or GS marked to EN60950 and EN60825-1.

C-TIC Statement

Conforms to AS/NZS N10410.

Patents

The IMAGETEAM 3800 product is covered by the following U.S. Patents: 5,831,254; 5,900,613; 5,932,862; 5,942,741; 5,965,863; 6,119,939; 6,164,544; 6,254,003 B1; 6,275,388 B1, 6,371,374 B1. Other U.S. and foreign patents pending.



Table of Contents

Chapter 1 - Getting Started

Typical Applications for the IT3900	1-1
About This Manual	1-1
Unpacking the Scanner	1-2
IT3800 Scanner Identification	1-3
IT3900 Scanner Identification	1-3
Connecting the Scanner When Powered by Host (Keyboard Wedge)	1-4
Mounting Information for the IMAGETEAM 3900	1-5
Specular Zone	1-6
Plug and Play	1-6
IBM 4683 Ports 5B, 9B, and 17 Interface	1-9
USB Interface	1-10
USB Converter	1-11
OCIA Interface	1-12
NCR OCIA Short Format (8 Bit) Interface	1-12
NCR OCIA Long Format (9 Bit) Interface	1-13
Nixdorf OCIA Interface	1-13
Serial Wedge	1-14

Chapter 2 - Terminal Interfaces

Keyboard Wedge Connection	2-1
Terminal ID	2-2
Supported Terminals	2-3
Keyboard Country	2-5
Keyboard Style	2-6
Keyboard Modifiers	2-7

Serial Port Connection	2-9
Baud Rate	2-10
RS-232 Word Length: Data Bits, Stop Bits, and Parity.....	2-11
RS-232 Handshaking.....	2-13
Wand Emulation Connection.....	2-14
Wand Emulation Transmission Rate	2-15
Wand Emulation Polarity	2-15
Wand Emulation Idle.....	2-16
PDF417 Wand Emulation	2-16
Data Block Size	2-16
Delay Between Blocks.....	2-17
Overall Checksum	2-17

Chapter 3 - Output

Scan Rate.....	3-1
Beeper Volume.....	3-1
Beeper Tone	3-2
Scan Voting.....	3-2
Reduce Quiet Zone.....	3-2
Reread Delay	3-3
Good Read Delay	3-4
Trigger Mode	3-4

Chapter 4 - Data Editing

Prefix/Suffix Overview	4-1
To Add a Prefix or Suffix:.....	4-2
To Clear One or All Prefixes or Suffixes:.....	4-3
To Add a Carriage Return Suffix to all Symbolologies	4-3
Prefix Selections	4-4
Suffix Selections.....	4-4
Symbology Chart	4-5
Decimal to Hex to ASCII Conversion Chart.....	4-6
Function Code Transmit	4-7

Intercharacter, Interfunction, and Intermassage Delays	4-7
Intercharacter Delay	4-8
User Specified Intercharacter Delay	4-9
Interfunction Delay	4-10
Intermessage Delay	4-10

Chapter 5 - Data Formatting

Data Format Editor Introduction	5-1
To Add a Data Format	5-1
Other Programming Selections	5-2
Data Format Editor Commands	5-2
Data Format Editor	5-4
Data Formatter	5-5
Alternate Data Formats	5-5

Chapter 6 - Secondary Interface

Secondary Code 39 Wand Emulation	6-1
Secondary RS-232 Connection	6-1
Secondary Non Decoded Output Laser Emulation	6-2
Non Decoded Output Laser Emulation Transmission Rate ..	6-2
Non Decoded Output Laser Emulation Polarity.....	6-2
Non Decoded Laser Emulation Idle	6-3
Disabling the Secondary Interface	6-3
Secondary Trigger Mode.....	6-3

Chapter 7 - Symbologies

Introduction	7-1
All Symbologies	7-1
Codabar	7-2
Start/Stop Characters.....	7-2
Check Character.....	7-3
Concatenation	7-4
Message Length	7-4

Code 39	7-6
Start/Stop Characters	7-6
Check Character	7-7
Message Length.....	7-7
Code 39 Append	7-8
Base 32	7-8
Full ASCII	7-9
Interleaved 2 of 5	7-10
Check Digit.....	7-10
Message Length.....	7-11
Strict Decoding.....	7-11
Code 93	7-12
Message Length.....	7-12
Code 2 of 5	7-13
Message Length.....	7-13
IATA Code 2 of 5	7-14
Message Length.....	7-14
Matrix 2 of 5.....	7-15
Message Length.....	7-15
Code 11	7-16
Check Digits Required.....	7-16
Message Length.....	7-16
Code 128	7-18
<GS> Substitution	7-18
Message Length.....	7-18
Telepen.....	7-20
Telepen Output	7-20
Message Length.....	7-20
UPC A	7-22
Check Digit.....	7-22
Number System	7-22
Addenda.....	7-23
Addenda Required	7-23
Addenda Separator	7-24
UPC Strict Decoding	7-24

UPC E0 and UPC E1	7-25
UPC E Expand	7-25
Check Digit	7-26
Number System	7-26
Addenda	7-27
Addenda Required	7-27
Addenda Separator	7-28
EAN/JAN 13	7-29
Check Digit	7-29
Addenda	7-30
Addenda Required	7-30
Addenda Separator	7-31
ISBN Enable	7-31
EAN/JAN 8	7-32
Check Digit	7-32
Addenda	7-33
Addenda Required	7-33
Addenda Separator	7-34
MSI	7-35
Check Character	7-35
Message Length	7-36
Plessey	7-37
Message Length	7-37
RSS-14	7-38
RSS-14 Limited	7-38
RSS-14 Expanded	7-39
Message Length	7-39
China Post Code	7-40
Message Length	7-40
PDF417	7-41
Message Length	7-41
Show GLI Blocks	7-42
Scan Diagnostics	7-42
PDF Learn Mode	7-43
MicroPDF417	7-44
MicroPDF417	7-44
Message Length	7-44

EAN•UCC Composite Symbology	7-46
EAN•UCC Composite.....	7-46
Enable UPC/EAN Version.....	7-46
EAN•UCC Composite Symbology Message Length ...	7-47

Chapter 8 - Cloning

Procedure.....	8-1
----------------	-----

Chapter 9 - Visual Menu

Visual Menu Introduction	9-1
Temporary Visual Menu Configuration	9-1
Installing Visual Menu from the Web	9-2
Upgrading USB Firmware.....	9-2

Chapter 10 - Interface Keys

Keyboard Function Relationships	10-1
Supported Interface Keys.....	10-3

Chapter 11 - Utilities

To Add a Test Code I.D. Prefix to All Symbologies	11-1
Show Software Revision.....	11-1
Show Data Format.....	11-1
Specular Effect Reduction.....	11-2

Chapter 12 - Default Charts

Resetting the Factory Settings	12-1
Communication (RS-232) Selections	12-1
Wand Emulation Selections.....	12-2
PDF417 Wand Emulation Selections	12-2
Output Selections	12-2
Data Editing Selections.....	12-3
Secondary Interface Selections.....	12-3
Codabar Selections	12-3
Code 39 Selections.....	12-3
Interleaved 2 of 5 Selections.....	12-4
Code 93 Selections.....	12-4
Code 2 of 5 Selections	12-4
IATA Code 2 of 5 Selections.....	12-4
Matrix 2 of 5 Selections.....	12-4
Code 11 Selections.....	12-5
Code 128 Selections.....	12-5
Telepen Selections	12-5
UPC A.....	12-5
UPC E	12-5
EAN/JAN 13	12-6
EAN/JAN 8.....	12-6
MSI Selections	12-7
Plessey Selections	12-7
RSS-14 Selections.....	12-7
China Post Code.....	12-7
PDF417 Symbology Selections	12-7
MicroPDF417 Selections	12-8
EAN•UCC Composite Symbology Selections	12-8

Chapter 13 - Serial Programming Commands

Conventions	13-1
Menu Command Syntax	13-1
Query Commands	13-2
Concatenation of Multiple Commands	13-2
Trigger Commands.....	13-4

Menu Commands	13-5
---------------------	------

Chapter 14 - Product Specifications

IMAGETEAM 3800 Product Specifications	14-1
IMAGETEAM 3900 Product Specifications	14-2
Standard Cable Pinouts	14-3
Scan Maps	14-8

Chapter 15 - Maintenance

Repairs.....	15-1
Maintenance	15-1
Replacing the Interface Cable.....	15-2
Troubleshooting	15-2
Application Support	15-4

Chapter 16 - Customer Support

Obtaining Factory Service.....	16-1
Help Desk.....	16-3
Limited Warranty	16-4

Getting Started

The IMAGETEAM™ (IT) 3800 is a high performance linear imaging scanner from HHP. The IT3800 marks a new performance level for hand held scanners. Linear imaging technology is defined by a bright and sharply focused aiming line, high resolution imaging, and fast reading speed. The IT3800 is comfortable to hold, easy to use, rugged, and excellent for all general scanning applications.

The IMAGETEAM™ (IT) 3900 is a fixed mount bar code scanner designed for retail kiosks, manufacturing WIP tracking, document processing, or other OEM applications. It is a complete decoded output scanner that is easy to integrate. It communicates with PCs or host terminals via keyboard wedge or a serial RS-232 interface. The IT3900 can be used internally or externally. The housing provides protection from dust, dirt, and electrostatic discharge.

Typical Applications for the IT3900

The IT3900 is an ideal scanner for retail kiosks. The bright aiming line and large working range make scanning easy for untrained users.

The IT3900 mounted in a stand makes an efficient bar code document reader; it takes up a minimum of counter space and reads and transmits data quickly.

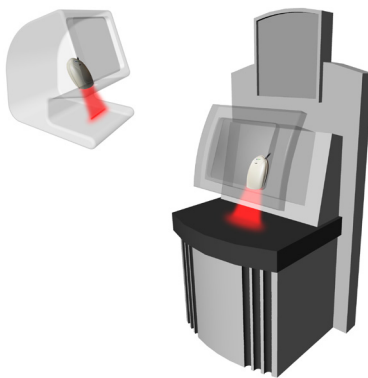

About This Manual

This User's Guide provides installation and programming instructions for the IMAGETEAM 3800/3900. Product specifications, dimensions, warranty, and customer support information are also included.

HHP's bar code scanners are factory programmed for the most common terminal and communications settings. If you need to change these settings, programming is accomplished by scanning the bar codes in this guide.

An asterisk (*) next to an option indicates the default setting.

Unpacking the Scanner

Open the carton. The shipping carton or container should contain:

An IMAGETEAM 3800:



or an IMAGETEAM 3900:



- Check to make sure everything you ordered is present.
- Save the shipping container for later storage or shipping.
- Check for damage during shipment. Report damage immediately to the carrier who delivered the carton.

IT3800 Scanner Identification

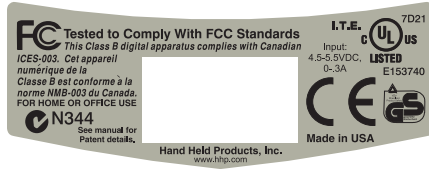
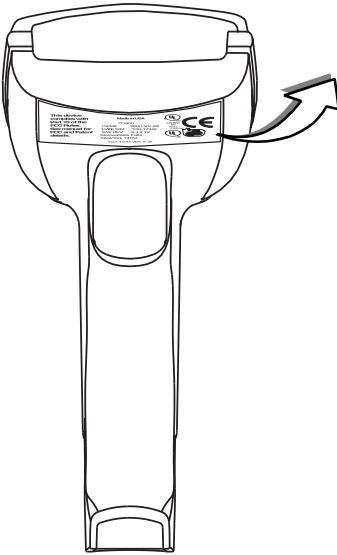

IT3900 Scanner Identification

**IT3900 Scanner
Bottom View**

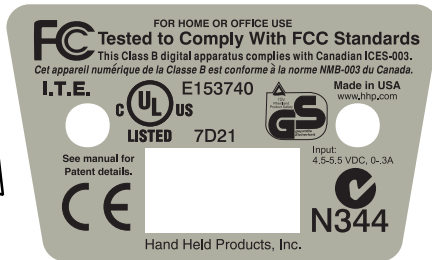
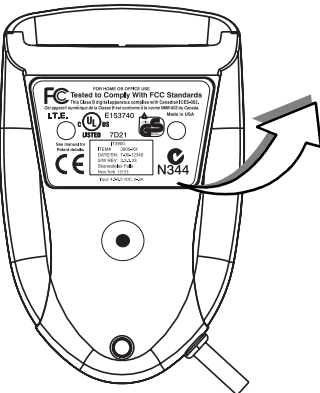

Connecting the Scanner When Powered by Host (Keyboard Wedge)

A scanner can be connected between the keyboard and PC as a “keyboard wedge,” plugged into the serial port, or connected to a portable data terminal in wand emulation or non decoded output mode. The following is an example of a keyboard wedge connection:

1. Turn off power to the terminal/computer.
2. Disconnect the keyboard cable from the back of the terminal/computer.

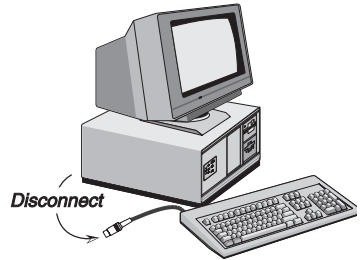

3. Connect the appropriate interface cable to the scanner and to the terminal/computer.

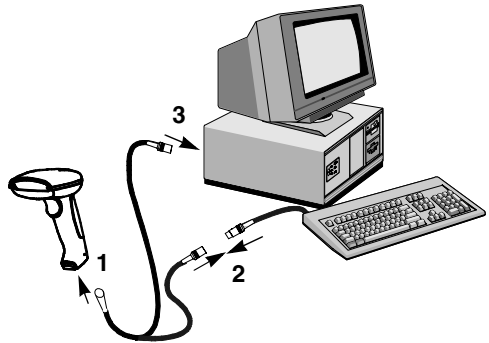

4. Turn the terminal/computer power back on. The scanner will beep twice.
5. Verify the scanner operation by scanning a bar code from the back cover of this manual. The scanner will beep once.

Mounting Information for the IMAGETEAM 3900

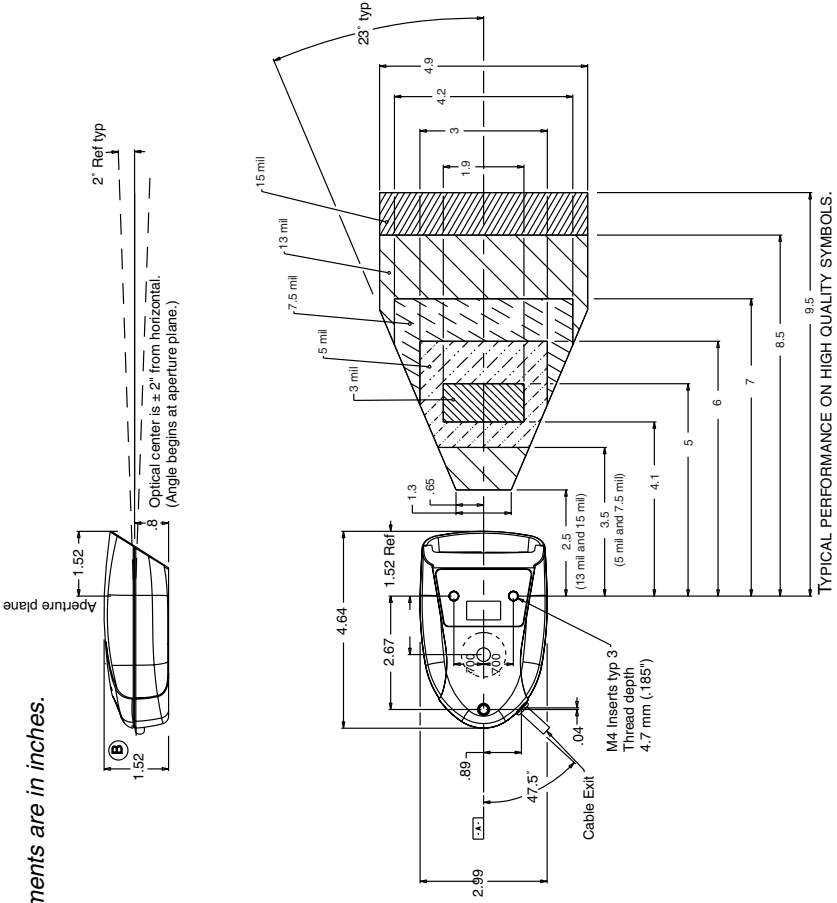

Mounting Information, continued

Specular Zone

The IT3900 must be mounted at a 5 degree, or greater, angle to the bar code in order to scan properly:

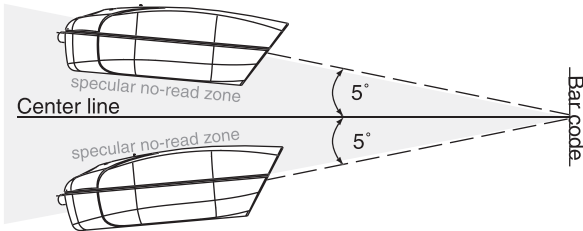

The scanner is now connected and ready to communicate with your terminal/PC. You must program the scanner for your interface before bar code data can be transmitted to your terminal/PC. If you are using the scanner as a keyboard wedge, turn to page 2-1. If the scanner is connected via a serial port, turn to page 2-9. If this is a wand emulation application, turn to page 2-16, and for a non decoded output connection, turn to page 6-2.

Plug and Play

Plug and Play bar codes provide instant scanner set up for commonly used interfaces.

Note: After you scan one of the codes, power cycle the host terminal to have the interface in effect.

The most common interface is Keyboard Wedge. The following Keyboard Wedge bar code also programs a carriage return (CR) suffix.



Keyboard Wedge Interface for IBM PC
AT and Compatibles

The following Plug and Play bar code for **IBM XT and Compatibles** also programs a carriage return (CR) suffix.



IBM XT and Compatibles

The following Plug and Play bar code for **IBM PS-2 and Compatibles** also programs a carriage return (CR) suffix.



IBM PS-2 and Compatibles

Use **Non Decoded Output Laser Emulation** when connecting to a secondary terminal with integral decoding. This also sets the transmission rate to 36 scans per second and the polarity to white high.



Non Decoded Output
Laser Emulation

For most laptops, scanning the **Laptop Direct Connect** bar code allows operation of the integral keyboard. The following Laptop Direct Connect bar code also programs a carriage return (CR) suffix.



Laptop Direct Connect

The RS-232 Interface bar code is used when connecting to the serial port of a PC or terminal. The following RS-232 Interface bar code adds a suffix of a CR and LF, and also programs the parameters:

<u>Option</u>	<u>Setting</u>
Baud Rate	9600 bps
Parity	Even
Data Format	7 data bits, parity bit, 1 stop bit (8 bit data)



RS-232 Interface

In Wand Emulation mode, the scanner decodes the bar code then sends data in the same format as a wand scanner. The **Same Code** format transmits UPC, EAN, Code 128 and Interleaved 2 of 5 bar codes without any changes, but converts all other symbologies to Code 39.



Wand Emulation Same Code

The following Wand Emulation bar code sets the interface to Wand Emulation mode and translates bar code data as Code 39 symbology. It also programs the Transmission Rate to 25 inches per second, and Output Polarity to black high.



Wand Emulation (Code 39 Format)

Note: For the 3800PDF model: When the 3800PDF interface is set to wand emulation, all PDF417 bar code data is transmitted as Code 128. Data from other symbologies follow the rules described above.

IBM 4683 Ports 5B, 9B, and 17 Interface

Note: The following Retail “Plug and Play” codes are for use with the 3800LR-11 and 3800LR-15 models only.

Scan one of the following “Plug and Play” codes to program the IT3800 for IBM 4683 Port 5B, 9B, or 17.

Note: After scanning one of these codes, you must re-boot the cash register.



IBM 4683 Port 5B Interface
(Default for -11 Models)



IBM 4683 Port 9B HHBCR-1 Interface



IBM 4683 Port 9B HHBCR-2 Interface



IBM 4683 Port 17 Interface

Each bar code above also programs the following suffixes for each symbology:

<u>Symbology</u>	<u>Suffix</u>
EAN 8	0C
EAN 13	16
UPC A	0D
UPC E	0A
Code 39	00 0A 0B
Interleaved 2 of 5	00 0D 0B
Code 128	00 18 0B

USB Interface

Note: The following USB “Plug and Play” codes (IBM SurePOS Hand Held and Tabletop Scanners) are for use with the 3800LX-15 model only.

Scan one of the following “Plug and Play” codes to program the IT3800 for IBM SurePos (USB Hand Held scanner) or IBM SurePos (USB Tabletop scanner).

Note: After scanning one of these codes, you must re-boot the cash register.



IBM SurePos (USB Hand Held Scanner) Interface



IBM SurePos (USB Tabletop Scanner) Interface

Each bar code above also programs the following suffixes for each symbology:

Symbology	Suffix
EAN 8	0C
EAN 13	16
UPC A	0D
UPC E	0A
Code 39	00 0A 0B
Interleaved 2 of 5	00 0D 0B
Code 128	00 18 0B

Note: The following USB “Plug and Play” codes (USB Keyboard - PC , USB Keyboard - Mac, and USB HID) are for use with the 3800LX-14 and 3800LX-15 models.

Scan one of the following codes to program the IT3800 for USB PC Keyboard or USB Macintosh Keyboard. Default = USB Keyboard (PC).



* USB Keyboard (PC)



USB Keyboard (Mac)

Scan the following code to program the IT3800 for USB HID bar code scanners.



USB HID Bar Code Scanner

USB Converter

Note: The USB converter is for use with the 3800-11 and 3800/3900-12 models only.

The IT3800-11, -12 and IT3900-12 models use a USB converter to simulate a USB keyboard. Data flows into applications as if entered from the keyboard. The USB converter is compatible with Apple iMac Series and Windows®98 and later PCs. Use cable set 42206062-01 to make the USB port connection.

To set up the USB communications, find the terminal ID in the Supported Terminal Chart on page 2-3, and follow the instructions on page 2-2. The PC and scanner automatically connect. Communications start immediately.

OCIA Interface

Note: *The OCIA interfaces are only available on the 3800LR-11 model.*

Scan one of the following “Plug and Play” codes to program the IT3800 for Generic OCIA, NCR OCIA Short Format (8 bit), NCR OCIA Long Format (9 bit), and Nixdorf OCIA.

Note: *After scanning one of these codes, you must re-boot the cash register.*



Generic OCIA Interface

The Generic OCIA bar code also programs the following prefixes for each symbology:

<u>Symbology</u>	<u>Prefix</u>
EAN 8	06 06
EAN 13	06
UPC A	01
UPC E	05

NCR OCIA Short Format (8 Bit) Interface



NCR OCIA Short Format (8 Bit) Interface

The NCR OCIA Short Format (8 Bit) bar code also programs the following prefixes for each symbology:

<u>Symbology</u>	<u>Prefix</u>
EAN 8	0F 0F
EAN 13	0F
UPC A	0A
UPC E	0E

NCR OCIA Long Format (9 Bit) Interface



NCR OCIA Long Format (9 Bit) Interface

The NCR OCIA Long Format (9 Bit) bar code also programs the following prefixes for each symbology:

<u>Symbology</u>	<u>Prefix</u>
EAN 8	46 46
EAN 13	46
UPC A	41
UPC E	45
Code 39	42 31
Interleaved 2 of 5	42 32
Code 128	42 33

Nixdorf OCIA Interface



Nixdorf OCIA Interface

The Nixdorf OCIA bar code also programs the following prefixes for each symbology:

<u>Symbology</u>	<u>Prefix</u>
EAN/UPC with Addenda	44 4B
Code 39	44 49
Interleaved 2 of 5	44 48
2 of 5	44 47
Code 128	44 4A

Serial Wedge

The IT3800/3900 uses true and TTL signal levels to wedge into an RS-232 serial network. Use IT3800/3900 serial wedge cables only to prevent damage to the scanner. Refer to the serial interface programming (pages 2-9 to 2-13) to set the baud rate and communications protocol.

To set up the serial wedge terminal ID, find the terminal ID in the Supported Terminal Chart and follow the instructions on page 2-2. Set the port to which you want the scanned data to transmit. Port 1 corresponds to P1 on the output cable and Port 2 corresponds to P2 on the output cable. Choosing Both sends scanned data to P1 and P2. *Default = P1.*



* P1



P2



Both P1 and P2

Terminal Interfaces

Keyboard Wedge Connection

IMAGETEAM 3800/3900 scanners are factory programmed for a keyboard wedge interface to an IBM PC AT with a USA keyboard. If this is your interface and you do not need to modify the settings, skip to Chapter 3 - Output.

If you have a different terminal and/or you want to make any keyboard wedge changes, scan the bar code below.



IBM PC AT and Compatibles
with CR suffix

Terminal ID

If your interface is not a standard PC AT, refer to "Supported Terminals" on page 2-3 through page 2-4, and locate the Terminal ID number for your PC. Scan the **Terminal ID** bar code below, then scan the numeric bar code(s) on the inside back cover of this manual to program the scanner for your terminal ID. Scan **Save** to save your selection.

For example, an IBM AT terminal has a Terminal ID of 003. You would scan the **Terminal ID** bar code, then **0, 0, 3** from the inside back cover, then **Save**. If you make an error while scanning the digits (before scanning Save), scan the **Discard** code on the back cover, scan the **Terminal ID** bar code, scan the digits, and the **Save** code again.



Terminal ID



Save

Note: After scanning one of these codes, you must power cycle your computer.

Supported Terminals

Terminal	Model(s)	Terminal ID
Apple Mac	Mac Classic, SE SE30, II (All)	049 **
Apple Mac Powerbook	5300 Series (Portable PC)	049 **
DEC	VT510, 520, 525 (PC style)	005
DEC	VT510, 520, 525 (DEC style LK411)	104
Esprit	200, 400	005
Heath Zenith	PC, AT	090
HP	Vectra	003
HP	Vectra ES	023
IBM	XT	001
IBM	PS/2 25, 30, 77DX2	002
IBM	AT, PS/2 30–286, 50, 55SX, 60, 70, 70–061, 70–121, 80	003 *
IBM 102 key	3161, 3162, 3163, 3191, 3192, 3194, 3196, 3197, 3471, 3472, 3476, 3477	006
IBM 122 key	3191, 3192, 3471, 3472	007
IBM 122 key	3196, 3197, 3476, 3477, 3486, 3482, 3488	008
IBM 122 key	3180	024
IBM 122 key	3180 data entry keyboard	114
IBM DOS/V 106 key	PC & Workstation	102
IBM SurePOS	USB Hand Held Scanner	128****
IBM SurePOS	USB Tabletop Scanner	129****
IBM Thinkpad	360 CSE, 340, 750	097
IBM Thinkpad		106
IBM Thinkpad	365, 755CV	003
I/O 122 key	2676D, 2677C, 2677D	008
ITT	9271	007
Lee Data	IIS	007
NEC	98XX Series	103
Olivetti	M19, M200	001
Olivetti	M240, M250, M290, M380, P500	003
RS-232 True		000***
RS-232 TTL		000
Serial Wedge		050
Silicon Graphics	Indy, Indigoll	005

Supported Terminals (Continued)

<u>Terminal</u>	<u>Model(s)</u>	<u>Terminal ID</u>
Telex 88 key	078, 078A, 79, 80, 191, 196, 1191,1192, 1471, 1472, 1476, 1477, 1483	025
Telex 88 key	Data Entry Keyboard	112
Telex 102 key	078, 078A, 79, 80, 191, 196, 1191,1192, 1471, 1472, 1476, 1477, 1483	045
Telex 122 key	078, 078A, 79, 80, 191, 196, 1191,1192, 1471, 1472, 1476, 1477, 1482, 1483	046
USB converter		124
USB PC Keyboard		124
USB Mac Keyboard		125
Wand Emulation		061

* Default for -12 model

** Applies to -12 models only

*** Default for -13 model (applies to -13 models only)

**** Applies to 3800LX-15 model only. Because special suffixes are required by the IBM SurePOS terminal, it is best to use the Plug and Play bar codes on page 1-9 to program these interfaces, rather than scanning the terminal ID listed in this table.

See page 1-9 for -11 model default.

Keyboard Country

Scan the **Program Keyboard Country** bar code below, then scan the numeric bar code(s) from the inside back cover, then the **Save** bar code to program the keyboard for your country. As a general rule, the following characters are not supported by the scanner for countries other than the United States:

@ | \$ # { } [] = / ' \ < > ~



Program Keyboard Country

Country Code	Scan	Country Code	Scan
Belgium	1	Italy	5
Denmark	8	Norway	9
Finland	2	Spain	10
France	3	Switzerland	6
Germany/Austria	4	USA (Default)	0
Great Britain	7		



Save

Keyboard Style

This programs keyboard styles, such as Caps Lock and Shift Lock. *Default = Regular.*

Regular is used when you normally have the Caps Lock key off.



* Regular

Caps Lock is used when you normally have the Caps Lock key on.



Caps Lock

Shift Lock is used when you normally have the Shift Lock key on (not common to U.S. keyboards).



Shift Lock

Automatic Caps Lock is used if you change the Caps Lock key on and off. The software tracks and reflects if you have Caps Lock on or off (AT and PS/2 only). This selection can only be used with systems that have an LED which notes the Caps Lock status.



Automatic Caps Lock

Emulate External Keyboard should be scanned if you do not have an external keyboard (IBM AT or equivalent). To connect the scanner to a laptop, it may be necessary to use the Automatic Direct Connect selection on page 2-8 in conjunction with the bar code below.



Emulate External Keyboard

Note: Note:After scanning the Emulate External Keyboard bar code, you must power cycle your computer.

Keyboard Modifiers

This modifies special keyboard features, such as CTRL+ ASCII codes and Turbo Mode.

Control + ASCII Mode On: The scanner sends key combinations for ASCII control characters for values 00-1F. Refer to page 10-1 for CTRL+ ASCII Values. *Default = Off*



Control + ASCII Mode On



* Control + ASCII Mode Off

Turbo Mode: The scanner sends characters to an IBM AT terminal faster. (For use with IBM AT only.) If the terminal drops characters, do not use Turbo Mode. *Default = Off*



Turbo Mode On



* Turbo Mode Off

Numeric Keypad Mode: Sends numeric characters as if entered from a numeric keypad. *Default = Off*



Numeric Keypad Mode On



* Numeric Keypad Mode Off

Automatic Direct Connect: Use this selection if you are using a laptop whose keyboard is disabled when you plug in the scanner. This selection can also be used if you have an IBM AT style terminal and the system is dropping characters. *Default = Off*



Automatic Direct
Connect Mode On



* Automatic Direct Connect
Mode Off

Serial Port Connection

All communication parameters between the scanner and terminal must match for correct data transfer through the serial port using RS-232 protocol. Scanning the RS-232 interface bar code, programs the scanner for an RS-232 interface at 9600 baud, even parity, 7 data bits, 1 stop bit (8 bit data), and adds a suffix of a CR LF.



RS-232 Interface

1. Turn off power to the terminal/computer.
2. Connect the appropriate interface cable to the scanner.

Note: For the scanner to work properly, you must have the correct cable for your type of terminal/computer.

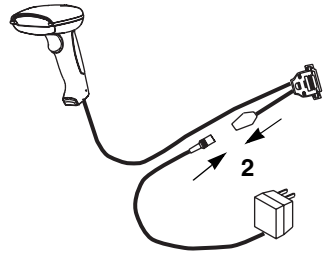

3. Plug the serial connector into the serial port on the back of your computer/terminal, as shown below. Tighten the two screws to secure the connector to the port.

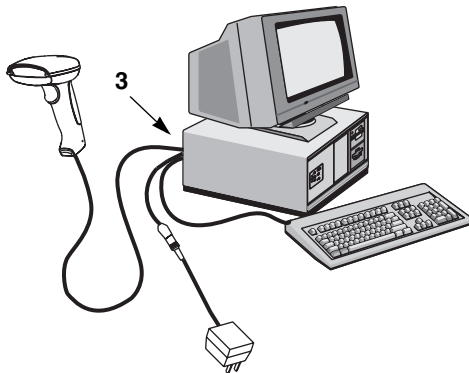

4. Plug the power pack into a power source.
5. Once the scanner has been fully connected, power up the terminal/computer.

Baud Rate

Baud Rate sends the data from the scanner to the terminal at the specified rate. The host terminal must be set for the same baud rate as the scanner.

Default = 9600.



300



600



1200



2400



4800



* 9600



19200



38400

RS-232 Word Length: Data Bits, Stop Bits, and Parity

Data Bits sets the word length at 7 or 8 bits of data per character. If an application requires only ASCII Hex characters 0 through 7F decimal (text, digits, and punctuation), select 7 data bits. For applications which require use of the full ASCII set, select 8 data bits per character. *Default = 7.*

Stop Bits sets the stop bits at 1 or 2. *Default = 1.*

Parity provides a means of checking character bit patterns for validity. *Default = Even.*



* 7 Data, 1 Stop, Parity Even



7 Data, 1 Stop, Parity None



7 Data, 1 Stop, Parity Odd



7 Data, 1 Stop, Parity Mark



7 Data, 1 Stop, Parity Space



7 Data, 2 Stop, Parity Even



7 Data, 2 Stop, Parity None



7 Data, 2 Stop, Parity Odd



7 Data, 2 Stop, Parity Mark

RS-232 Word Length: Data Bits, Stop Bits, and Parity
(continued)



8 Data, 1 Stop, Parity Even



8 Data, 1 Stop, Parity Odd



8 Data, 1 Stop, Parity Space



7 Data, 2 Stop, Parity Space



8 Data, 1 Stop, Parity None



8 Data, 1 Stop, Parity Mark

RS-232 Handshaking

RS-232 handshaking is a set of rules concerning the exchange of data between serially communicating devices. *Default = RTS/CTS, XON/XOFF and ACK/NAK Off*



RTS/CTS On



* RTS/CTS Off



XON/XOFF On



* XON/OFF Off



ACK/NAK On



* ACK/NAK Off

Wand Emulation Connection

In Wand Emulation mode, the scanner decodes the bar code then sends data in the same format as a wand scanner. The Code 39 Format converts all symbologies to Code 39. The Same Code Format transmits UPC, EAN, Code 128 and Interleaved 2 of 5 without any changes, but converts all other symbologies to Code 39. These codes set the transmission rate to 25 inches per second and the output polarity to black, high. *Default = Code 39 Format.*



* Code 39 Format



Same Code Format

Note: For the 3800PDF model: When the 3800PDF interface is set to wand emulation, all PDF417 bar code data is transmitted as Code 128. Data from other symbologies follow the rules described above.

Wand Emulation Transmission Rate

The Transmission Rate is limited by the terminal's ability to receive data without dropping characters. *Default = 25 inches/second.*



10



* 25



40



80



120



150



200

Wand Emulation Polarity

The Polarity can be sent as standard with black bars high, or reversed with white bars high. *Default = Black High.*



* Black High



White High

Wand Emulation Idle

The idle describes the state of the scanner when no data is being transmitted. When in Wand Emulation mode, you must set the scanner's idle state to match the idle state for the device to which the scanner is connected. *Default = Idle High.*



* Idle High



Idle Low

PDF417 Wand Emulation

Note: The following Wand Emulation functions are for use with the 3800PDF-12 scanner only.

Data Block Size

This transmits the PDF417 data in smaller blocks to prevent buffer overflow. *Default = 60.*



20



40



* 60



80

Delay Between Blocks

This sets the delay time between data blocks. *Default = 50ms.*



5ms



* 50ms



150ms



500ms

Overall Checksum

When this option is turned on, a computed check character is added at the end of the entire message. The check character is the character which when Exclusive-OR'd with every preceding character of the message yields a result of 0x00 (00H). *Default = Off.*



On



* Off



Output

Scan Rate

Adjusting the scan rate changes the current draw when scanning. The slower the scan rate, the lower the current draw. (The standby current remains the same.) Scan speeds are 270 s/s, 135 s/s, and 67 s/s. A scan speed of 270 draws the highest power and has the best performance. A scan speed of 135 has a medium draw with medium performance. A scan speed of 67 draws the lowest power and has the lowest performance. *Default = 270 s/s.*



* 270 s/s



135 s/s



67 s/s

Beeper Volume

Default = High.



* High



Medium



Low



Off

Beeper Tone

Default = Normal.



* Normal Beep



Short Beep

Scan Voting

This sets the number of times the same bar code has to be read before it is transmitted to the terminal. **Normal** uses the default values listed for the symbologies in the Default Charts beginning on page 12-1. **High** doubles the votes used below the threshold. *Default = Voting Normal.*



* Voting Normal



Voting High

Reduce Quiet Zone

Reducing the quiet zone requirements below AIM guidelines makes it possible to read off-spec bar codes. This feature is effective with all symbologies. *Default = Don't Reduce Quite Zone.*



* Don't Reduce Quiet Zone



Reduce Quiet Zone

Reread Delay

This sets the time period before the scanner can read the *same* bar code a second time. Setting a reread delay protects against accidental rereads of the same bar code. Longer delays are effective in minimizing accidental rereads at POS (point of sale). Use shorter delays in applications where repetitive bar code scanning is required. *Default = Short.*

Reread Delay only works when in automatic trigger mode (see page 3-4).



* Short



Medium



Long



Extra Long

Good Read Delay

This sets the minimum amount of time before the scanner can read another bar code. *Default = No Delay.*



* No Delay



Short Delay



Medium Delay



Long Delay

Trigger Mode

Manual/Serial Trigger: You can activate the scanner either by pressing the trigger, or using a serial trigger command (see "Trigger Commands" on page 13-4). When in manual trigger mode, the scanner scans until a bar code is read, or until the trigger is released.

When in serial mode, the scanner scans until a bar code has been read or until the deactivate command is sent. In serial mode, the scanner can also be set to turn itself off after a specified time has elapsed (see Serial Trigger Time Out, which follows). *Default for IT3800.*



Manual/Serial Trigger

Serial Trigger Time Out: Use this selection to set a time out (in quarter seconds) of the scanner's trigger when using serial commands to trigger the scanner. Once the scanner has timed out, it must be triggered again either serially (see "Manual/Serial Trigger: You can activate the scanner either by pressing the trigger, or using a serial trigger command (see "Trigger Commands" on page 13-4). When in manual trigger mode, the scanner scans

until a bar code is read, or until the trigger is released." on page 3-4), or manually. After scanning the Serial Trigger Time Out bar code, set the time out duration (from 0-1200 quarter seconds) by scanning digits from the inside back cover, then scanning **Save**. *Default = 0 (infinite, or no time out).*



Serial Trigger Time Out

Manual Trigger, Low Power: The scanner “sleeps,” using only 30 milliamps, until the trigger is pulled. When the trigger is pulled, the scanner wakes up and operates at reduced power until there is no triggering for the time set with the Low Power Time Out bar code. There is a short delay in operation when the scanner is first triggered, but there is no delay when operating in low power mode.



Manual Trigger, Low Power

Manual Trigger, Low Power cannot be used with keyboard wedge applications.

Low Power Time Out: Scan the Low Power Time Out bar code to change the time out duration. Then scan the time out duration (from 0-300 seconds) from the inside back cover, and **Save**. *Default = 2 minutes.*

If you make an error while scanning the digits (before scanning Save), scan Discard on the back cover, scan the Lower Power Time Out bar code, scan the correct digits, then Save again.



Low Power Time Out

Automatic Trigger: The scanner scans continuously at full power. *Default for IT3900.*



Automatic Trigger

Presentation Mode: The LEDs are off until a bar code is presented to the scanner. Then the LEDs turn on automatically to read the code. Presentation Mode uses normal office or store ambient light to detect the bar codes.



Presentation Mode

Note: Do not use Presentation Mode with a 3800/3900PDF. Normal office or store ambient light does not provide enough illumination for the 3800/3900PDF to work properly in Presentation Mode.

Data Editing

Prefix/Suffix Overview

When a bar code is scanned, additional information is sent to the host computer along with the bar code data. This group of bar code data and additional, user-defined data is called a "message string." The selections in this section are used to build the user-defined data into the message string.

Prefix and Suffix characters are data characters that can be sent before and after scanned data. You can specify if they should be sent with all symbologies, or only with specific symbologies. The following illustration shows the breakdown of a message string:

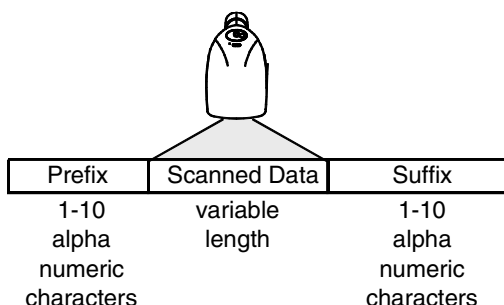

Points to Keep In Mind

- It is not necessary to build a message string. The selections in this chapter are only used if you wish to alter the default settings. *Default prefix = None. Default suffix = None.*
- A prefix or suffix may be added or cleared from one symbology or all symbologies.
- You can add any prefix or suffix from the ASCII chart (page 4-6), plus Code I.D. and Aim I.D.
- You can string together several entries for several symbologies at one time.
- Enter prefixes and suffixes in the order in which you want them to appear on the output.

To Add a Prefix or Suffix:

- Step 1.** Scan the **Add Prefix** or **Add Suffix** symbol (page 4-4).
- Step 2.** Determine the 2 digit Hex value from the Symbology Chart (page 4-5) for the symbology to which you want to apply the prefix or suffix.
- Step 3.** Scan the 2 hex digits from the Programming Chart inside the back cover or scan **9, 9** for all symbologies.
- Step 4.** Determine the hex value from the Decimal to Hex to ASCII Conversion Chart (page 4-6) for the prefix or suffix you wish to enter.
- Step 5.** Scan the 2 digit hex value from the Programming Chart inside the back cover.
- Step 6.** Repeat Steps 4 and 5 for every prefix or suffix character.
- Step 7.** To add the Code I.D., scan **5, C, 8, 0**.
To add AIM I.D., scan **5, C, 8, 1**.
To add a backslash (\), scan **5, C, 5, C**.
- Step 8.** Scan **Save** to exit and save, or scan **Discard** to exit without saving.
Repeat Steps 1-6 to add a prefix or suffix for another symbology.

Example: Add a Suffix to a specific symbology

To send a CR (carriage return) Suffix for UPC only:

- Step 1.** Scan **Add Suffix**.
- Step 2.** Determine the 2 digit hex value from the Symbology Chart (page 4-5) for UPC.
- Step 3.** Scan **6, 3** from the Programming Chart (inside back cover).
- Step 4.** Determine the hex value from the Decimal to Hex to ASCII Conversion Chart (page 4-6) for the CR (carriage return).
- Step 5.** Scan **0, D** from the Programming Chart (inside back cover).
- Step 6.** Scan **Save**, or scan **Discard** to exit without saving.

To Clear One or All Prefixes or Suffixes:

You can clear a single prefix or suffix, or clear all prefixes/suffixes for a symbology. When you Clear One Prefix (Suffix), the specific character you select is deleted from the symbology you want. When you Clear All Prefixes (Suffixes), all the prefixes or suffixes for a symbology are deleted.

Step 1. Scan the **Clear One Prefix** or **Clear One Suffix** symbol.

Step 2. Determine the 2 digit Hex value from the Symbology Chart (page 4-5) for the symbology from which you want to clear the prefix or suffix.

Step 3. Scan the 2 digit hex value from the Programming Chart inside the back cover or scan **9, 9** for all symbologies.

Your change is automatically saved.

To Add a Carriage Return Suffix to all Symbologies

Scan the following bar code if you wish to add a Carriage Return Suffix to all symbologies at once. This action first clears all current suffixes, then programs a carriage return suffix for all symbologies.



Add CR Suffix
All Symbologies

Prefix Selections



Add Prefix



Clear One Prefix



Clear All Prefixes

Suffix Selections



Add Suffix



Clear One Suffix



Clear All Suffixes



Save



Discard

Symbology Chart

Symbology	Code ID	AIM ID	Hex ID	Symbology	Code ID	AIM ID	Hex ID
China Postal	q]X0	71	Interleaved 2 of 5	e]I0	65
Codabar	a]F0	61	Matrix 2 of 5	m]X0	6D
Code 2 of 5	f]S0	66	MicroPDF417	R]L0	52
Code 11	h]H0	68	MSI	g]M0	67
Code 39	b]A0	62	PDF417	r]L0	72
Code 39 PARAF	w]X0	77	Plessey	n]P0	6E
Code 93	i]G0	69	RSS-14	y]e0	79
Code 128	j]C0	6A	Telepen	t]B0	74
EAN/JAN	d]E0	64	UPC	c]E0	63
EAN-UCC Composite	y]e0	79	<i>All Symbologies †</i>			<i>99</i>
IATA 2 of 5	f]R0	66				

Note: Prefix/Suffix entries for specific symbologies override the universal (*All Symbologies, 99*) entry.

† *All Symbologies: Prefix/Suffix programming only!*

Decimal to Hex to ASCII Conversion Chart

Dec.	Hex	ASCII	Dec.	Hex	ASCII	Dec.	Hex	ASCII	Dec.	Hex	ASCII
0	00	NUL	32	20	SP	64	40	@	96	60	`
1	01	SOH	33	21	!	65	41	A	97	61	a
2	02	STX	34	22	"	66	42	B	98	62	b
3	03	ETX	35	23	#	67	43	C	99	63	c
4	04	EOT	36	24	\$	68	44	D	100	64	d
5	05	ENQ	37	25	%	69	45	E	101	65	e
6	06	ACK	38	26	&	70	46	F	102	66	f
7	07	BEL	39	27	'	71	47	G	103	67	g
8	08	BS	40	28	(72	48	H	104	68	h
9	09	HT	41	29)	73	49	I	105	69	i
10	0A	LF	42	2A	*	74	4A	J	106	6A	j
11	0B	VT	43	2B	+	75	4B	K	107	6B	k
12	0C	FF	44	2C	,	76	4C	L	108	6C	l
13	0D	CR	45	2D	-	77	4D	M	109	6D	m
14	0E	SO	46	2E	.	78	4E	N	110	6E	n
15	0F	SI	47	2F	/	79	4F	O	111	6F	o
16	10	DLE	48	30	0	80	50	P	112	70	p
17	11	DC1	49	31	1	81	51	Q	113	71	q
18	12	DC2	50	32	2	82	52	R	114	72	r
19	13	DC3	51	33	3	83	53	S	115	73	s
20	14	DC4	52	34	4	84	54	T	116	74	t
21	15	NAK	53	35	5	85	55	U	117	75	u
22	16	SYN	54	36	6	86	56	V	118	76	v
23	17	ETB	55	37	7	87	57	W	119	77	w
24	18	CAN	56	38	8	88	58	X	120	78	x
25	19	EM	57	39	9	89	59	Y	121	79	y
26	1A	SUB	58	3A	:	90	5A	Z	122	7A	z
27	1B	ESC	59	3B	;	91	5B	[123	7B	{
28	1C	FS	60	3C	<	92	5C	\	124	7C	
29	1D	GS	61	3D	=	93	5D]	125	7D	}
30	1E	RS	62	3E	>	94	5E	^	126	7E	~
31	1F	US	63	3F	?	95	5F	_	127	7F	DEL

Function Code Transmit

When this selection is enabled and function codes are contained within the scanned data, the scanner transmits the function code to the terminal. Charts of these function codes are provided in Section 10, Supported Interface Keys. When the scanner is in keyboard wedge mode, the scan code is converted to a key code before it is transmitted. *Default = Enable.*



* Enable



Disable

Intercharacter, Interfunction, and Intermessage Delays

Some terminals drop information (characters) if data comes through too quickly. Intercharacter, interfunction, and intermessage delays slow the transmission of data, increasing data integrity.

Each delay is composed of a 5 millisecond step. You can program up to 99 steps (of 5 ms each).

Intercharacter Delay

This is a delay of up to 495 milliseconds (in multiples of 5) placed between the transmission of each character of scanned data. You can program up to 99 steps (of 5 ms each). Scan the Intercharacter Delay bar code below, then scan the number of steps, and the **SAVE** bar code from the inside back cover.

*Note: If you make an error while scanning the digits (before scanning Save), scan **Discard** on the back cover, scan the Intercharacter Delay bar code, scan the correct digits, and **Save** again.*

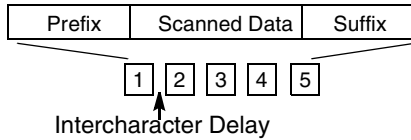

To remove this delay, scan the Intercharacter Delay bar code, then set the number of steps to 00. Scan the **SAVE** bar code from the inside back cover.

User Specified Intercharacter Delay

This is a delay of up to 495 milliseconds (in multiples of 5) placed after the transmission of a particular character of scanned data. You can program up to 99 steps (of 5 ms each) to follow the character you specify. Scan the Delay Length bar code below, then the number of steps for the delay, and the **SAVE** bar code from the inside back cover.

Next, scan the Character to Trigger Delay bar code, then the 2 digit hex value for the ASCII character that will trigger the delay (refer to the Decimal to Hex to ASCII conversion chart on page 4-5).

Note: If you make an error while scanning the digits (before scanning Save), scan Discard on the inside back cover, scan the Character to Trigger Delay bar code, scan the correct digits, and Save again.



Character to Trigger Delay



Delay Length

To remove this delay, scan the Delay Length bar code, and set the number of steps to 00. Scan the **SAVE** bar code from the inside back cover.

Interfunction Delay

This is a delay of up to 495 milliseconds (in multiples of 5) placed between the transmission of each segment of the message string. You can program up to 99 steps (of 5 ms each). Scan the Interfunction Delay bar code below, then scan the number of steps, and the **SAVE** bar code from the inside back cover.

Note: If you make an error while scanning the digits (before scanning Save), scan Discard on the inside back cover, scan the Interfunction Delay bar code, scan the correct digits, and Save again.

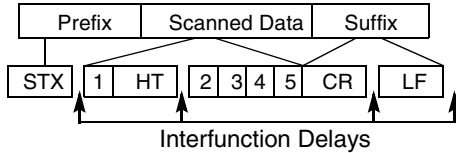

To remove this delay, scan the Interfunction Delay bar code, then set the number of steps to 00. Scan the **SAVE** bar code from the inside back cover.

Intermessage Delay

This is a delay of up to 495 milliseconds (in multiples of 5) placed between each scan transmission. You can program up to 99 steps (of 5 ms each). Scan the Intermessage Delay bar code below, then scan the number of steps, and the **SAVE** bar code from the inside back cover.

Note: If you make an error while scanning the digits (before scanning Save), scan Discard on the inside back cover, scan the Intermessage Delay bar code, scan the correct digits, and Save again.

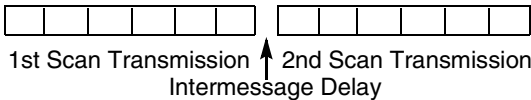

To remove this delay, scan the Intermessage Delay bar code, then set the number of steps to 00. Scan the **SAVE** bar code from the inside back cover.

Data Formatting

Data Format Editor Introduction

The Data Format Editor selections are used to edit scanned data. For example, you can use the Data Format Editor to insert characters at certain points in bar code data as it is scanned. It is not necessary to use the Data Format Editor. A set of defaults for the data format is already programmed in the scanner. The selections in the following pages are used only if you wish to alter the default settings. *Default Data Format setting = none.*

If you have changed data format settings, and wish to clear all formats and return to the defaults, scan the **Default Data Format** code on page 5-4.

To Add a Data Format

Step 1. Scan the **Enter Data Format** symbol (page 5-4).

Step 2. Primary/Alternate Format

Determine if this will be your primary data format, or one of 3 alternate formats. (Alternate formats allow you “single shot” capability to scan one bar code using a different data format. After the one bar code has been read, the scanner reverts to the primary data format. See page 5-5.) If you are programming the primary format, scan **0**. If you are programming an alternate format, scan **1**, **2**, or **3**, depending on the alternate format you are programming.

Step 3. Terminal Type

Refer to the Supported Terminals Chart (page 2-3) and locate the Terminal ID number for your PC. Scan three numeric bar codes on the inside back cover to program the scanner for your terminal ID (you must enter 3 digits). For example, scan **0 0 3** for an AT wedge.

Note: The wildcard for all terminal types is 099.

Step 4. Code I.D.

On page 4-5, find the symbology to which you want to apply the data format. Locate the Hex value for that symbology and scan the 2 digit hex value from the Programming Chart.

Step 5. Length

Specify what length (up to 9999 characters) of data will be acceptable for this symbology. Scan the four digit data length from the Programming Chart. (Note: 50 characters is entered as 0050. 9999 is a universal number, indicating all lengths.)

Step 6. Editor Commands

Refer to the Format Editor Commands Chart (page 5-2). Scan the symbols that represent the command you want to enter. 94 alphanumeric characters may be entered for each symbology data format.

Step 7. Scan **Save** to save your entries.

Other Programming Selections

- **Clear One Data Format**
This deletes one data format for one symbology. If you are clearing the primary format, scan **0**. If you are clearing an alternate format, scan **1**, **2**, or **3**, depending on the alternate format you are clearing. Scan the Terminal Type (refer to the Supported Terminals Chart on page 2-3), Code I.D. and the length of the format you want to delete. That length data format for that symbology is deleted and all other formats are unaffected.
- **Save**
This exits, saving any Data Format changes.
- **Discard**
This exits without saving any Data Format changes.

Data Format Editor Commands

Send Commands

- F1 Send all characters followed by “xx” key or function code, starting from current cursor position. **Syntax = F1xx** (xx stands for the hex value for an ASCII code, see Decimal to Hex to ASCII Conversion chart, page 4-6.)
- F2 Send “nn” characters followed by “xx” key or function code, starting from current cursor position. **Syntax = F2nnxx** (nn stands for the numeric value (00-99) for the number of characters and xx stands for the hex value for an ASCII code. See Decimal to Hex to ASCII Conversion chart, page 4-6.)
- F3 Send up to but not including “ss” character (Search and Send) starting from current cursor position, leaving cursor pointing to “ss” character followed by “xx” key or function code. **Syntax = F3ssxx** (ss and xx both stand for the hex values for ASCII codes, see Decimal to Hex to ASCII Conversion chart, page 4-6.)
- F4 Send “xx” character “nn” times (Insert) leaving cursor in current cursor position. **Syntax = F4xxnn** (xx stands for the hex value for an ASCII code, see Decimal to Hex to ASCII Conversion chart, page 4-6, and nn is the numeric value (00-99) for the number of times it should be sent.)
- E9 Send all but the last “nn” characters, starting from the current cursor position. **Syntax = E9nn** (nn is the numeric value (00-99) for the number of characters that will not be sent at the end of the message.)

Move Commands

- F5 Move the cursor ahead “nn” characters from current cursor position. **Syntax = F5nn** (nn stands for the numeric value (00-99) for the number of characters the cursor should be moved ahead.)
- F6 Move the cursor back “nn” characters from current cursor position. **Syntax = F6nn** (nn stands for the numeric value (00-99) for the number of characters the cursor should be moved back.)
- F7 Move the cursor to the beginning of the data string. **Syntax = F7.**
- EA Move the cursor to the end of the data string. **Syntax = EA**

Search Commands

- F8 Search ahead for “xx” character from current cursor position, leaving cursor pointing to “xx” character. **Syntax = F8xx** (xx stands for the hex value for an ASCII code, see Decimal to Hex to ASCII Conversion chart, page 4-6.)
- F9 Search back for “xx” character from current cursor position, leaving cursor pointing to “xx” character. **Syntax = F9xx** (xx stands for the hex value for an ASCII code, see Decimal to Hex to ASCII Conversion chart, page 4-6.)
- E6 Search ahead for the first non “xx” character from the current cursor position, leaving cursor pointing to non “xx” character. **Syntax = E6xx** (xx stands for the hex value for an ASCII code, see Decimal to Hex to ASCII Conversion chart, page 4-6.)
- E7 Search back for the first non “xx” character from the current cursor position, leaving cursor pointing to non “xx” character. **Syntax = E7xx** (xx stands for the hex value for an ASCII code, see Decimal to Hex to ASCII Conversion chart, page 4-6.)

Miscellaneous Commands

- FB Suppress all occurrences of up to 15 different characters, starting at the current cursor position, as the cursor is advanced by other commands. When the FC command is encountered, the suppress function is terminated. The cursor is not moved by the FB command. **Syntax = FBnnxxyy . .zz** where nn is a count of the number suppress characters in the list and xxyy . . zz is the list of characters to be suppressed. (xx stands for the hex value for an ASCII code, see Decimal to Hex to ASCII Conversion chart, page 4-6.)
- FC Disable suppress filter and clear all suppressed characters. **Syntax = FC.**
- E4 Replaces up to 15 characters in the data string with user specified characters. Replacement continues until the E5 command is encountered. **Syntax = E4nnxx₁xx₂yy₁yy₂...ZZ₁ZZ₂** where nn is the total count of both characters to be replaced plus replacement characters; xx₁ defines characters to be replaced and xx₂ defines replacement characters, continuing through zz₁ and zz₂.
- E5 Terminates character replacement. **Syntax = E5.**
- FE Compare character in current cursor position to the character “xx.” If characters are equal, increment cursor. If characters are not equal, no format match. **Syntax = FExx** (xx stands for the hex value for an ASCII code, see Decimal to Hex to ASCII Conversion chart, page 4-6.)
- EC Check to make sure there is an ASCII number at the current cursor position. If character is not numeric, format is aborted. **Syntax = EC.**
- ED Check to make sure there is a non-numeric ASCII character at the current cursor position. If character is numeric, format is aborted. **Syntax = ED.**

Data Format Editor



Enter Data Format



Default Data Format



Clear One Data Format



Clear All Data Formats



Save



Discard

Data Formatter

When Data Formatter is turned off, the bar code data is output to the host as read (including prefixes and suffixes). Choose one of the following options. *Default = Data Formatter On.*



* Data Formatter On,
but Not Required



Data Formatter Off

When Data Formatter is required, all input data must conform to an edited format or the scanner does not transmit the input data to the host device.



Data Format On, Format Required

Alternate Data Formats

Alternate formats allow you “single shot” capability to scan one bar code using a different data format than your primary format. When data formats are programmed (see page 5-1), you must input whether you are programming the primary format, or an alternate format numbered 1, 2, or 3.

An alternate format is initiated by scanning one of the 3 alternate format bar codes below. The scanner will scan the next bar code, formatting the data with the selected alternate format, then revert immediately to the primary format.



Alternate Data Format 1



Alternate Data Format 2



Alternate Data Format 3



Secondary Interface

By switching interface cables, the IT3800/3900 scanner can communicate with a portable data terminal (secondary interface), in addition to the host terminal (primary interface).

Note: Secondary interfaces do not apply to the IT3800LX-15.

The secondary interface can be programmed at any time.

Secondary Code 39 Wand Emulation

In Wand Emulation mode, the scanner decodes the bar code then sends data in the same format as a wand scanner. The Code 39 Format converts all symbologies to Code 39. The Same Code Format transmits UPC, EAN, Code 128 and Interleaved 2 of 5 without any changes, but converts all other symbologies to Code 39. These codes set the transmission rate to 25 inches per second and the output polarity to black, high. *Default = Code 39 Format.*



* Wand Emulation
Code 39 Format



Wand Emulation
Same Code Format

Note for the 3800PDF model: When the 3800PDF interface is set to wand emulation, all PDF417 bar code data is transmitted as Code 128. Data from other symbologies follow the rules described above.

Secondary RS-232 Connection

All communication parameters between the scanner and terminal must match for correct data transfer through the serial port using RS-232 protocol.

RS-232 programmable selections are used by both the primary and secondary interfaces. Changing an RS-232 parameter (e.g., baud rate or parity), while in primary or secondary mode will affect both interfaces.



RS-232 Interface

Secondary Non Decoded Output Laser Emulation

Use this selection when connecting to a secondary terminal with integral decoding. This also sets the transmission rate to 36 scans per second and the polarity to white high.



Non Decoded Output Laser Emulation Transmission Rate

The Transmission Rate is limited by the terminal's ability to receive data without dropping characters. *Default = 36 scans/second.*



Non Decoded Output Laser Emulation Polarity

The Polarity can be sent as standard with white bars high, or reversed with black bars high. *Default = White High.*



Non Decoded Laser Emulation Idle

The idle describes the state of the scanner when no data is being transmitted. When in Non Decoded mode, you must set the scanner's idle state to match the idle state for the device to which the scanner is connected. *Default = High.*



Low



* High

Disabling the Secondary Interface

You can temporarily disable the secondary interface, but still retain the secondary interface settings in the scanner's memory by scanning the Disable bar code below. To re-enable the secondary interface, scan the Enable bar code. *Default = Disable.*



* Disable



Enable

Secondary Trigger Mode

Manual Trigger: You must press the scanner trigger to scan. When not scanning, idle power is maintained. *Default = Manual Trigger.*



* Manual Trigger

Automatic Trigger: The scanner scans continuously at full power.



Automatic Trigger

Manual Trigger, Low Power: The scanner “sleeps,” using only 30 milliamps, until the trigger is pulled. When the trigger is pulled, the scanner wakes up and operates at normal power until there is no triggering for the time set with the Low Power Time Out bar code. Then, the scanner goes to “sleep” again.

Low Power Time Out: Scan the Low Power Time Out bar code to change the time out duration. Then scan the time out duration (from 0-300 seconds) from the inside back cover and **Save**. *Default = 2 minutes.*

Note: If you make an error while scanning the digits (before scanning Save), scan Discard on the back cover, scan the Low Power Time Out bar code, scan the correct digits, and Save again.



Manual Trigger, Low Power



Low Power Time Out

Note: The Secondary Manual Trigger, Lower Power option is not available on the 3800LR-11 in Secondary Non-Decoded Out Laser Emulation Mode.

Symbologies

Introduction

Use this section to program the scanner for Industrial, Retail, and PDF417 Symbology selections.

This programming section contains the following menu selections:

All Symbologies	IATA Code 2 of 5
China Post Code	Interleaved 2 of 5
Codabar	Matrix 2 of 5
Code 2 of 5	MicroPDF417
Code 11	MSI
Code 39	PDF417
Code 39 PARAF	Plessey
Code 93	RSS-14
Code 128	Telepen
EAN/JAN	UPC
EAN•UCC Composite	

All Symbologies

If you want to decode all the symbologies allowable for your scanner, scan the **All Symbologies On** code.



All Symbologies On



All Symbologies Off

Codabar

<Default All Codabar Settings>



Codabar



* On



Off

Start/Stop Characters

Start/Stop characters identify the leading and trailing ends of the bar code. You may either transmit, or not transmit Start/Stop characters.
Default = Don't Transmit.



Transmit



* Don't Transmit

Codabar (continued)

Check Character

Codabar check characters are created using different “modulos.” You can program the scanner to read only Codabar bar codes with Modulo 16 check characters. *Default = No Check Character.*

No Check Character indicates that the scanner reads and transmits bar code data with or without a check character.

When Check Character is set to **Validate and Transmit**, the scanner will only read Codabar bar codes printed with a check character, and will transmit this character at the end of the scanned data.

When Check Character is set to **Validate, but Don't Transmit**, the unit will only read Codabar bar codes printed **with** a check character, but will not transmit the check character with the scanned data.



* No Check Character



Validate Modulo 16, but
Don't Transmit



Validate Modulo 16 and Transmit

Concatenation

Codabar supports symbol concatenation. When you **Enable** concatenation, the scanner looks for a Codabar symbol having a “D” start character, adjacent to a symbol having a “D” stop character. In this case the two messages are concatenated into one with the “D” characters omitted. *Default = On.*



Select **Require** to prevent the scanner from decoding a lone Codabar symbol.



* On



Off



Require

Message Length

The message length selection is used to set the valid reading length of the bar code. If the data length of the scanned bar code doesn't match the valid reading length, the scanner will issue an error beep. You may wish to set the same value for minimum and maximum length to force the scanner to read fixed length bar code data. This helps reduce the chances of a misread.

EXAMPLE: Decode only those bar codes with a count of 9-20 characters.
Min. length = 09 Max. length = 20

EXAMPLE: Decode only those bar codes with a count of 15 characters.
Min. length = 15 Max. length = 15

For a value other than the minimum and maximum message length defaults, scan the bar codes below, then scan the 2-digit value and **Save** bar codes on the Programming Chart inside the back cover. Minimum and Maximum lengths = 2-60.

*Note: If you make an error while scanning the digits (before scanning Save), scan Discard on the back cover, scan the **Minimum** or **Maximum** bar code, scan the correct digits, and **Save** again.*



Minimum (Default =4)



Maximum (Default =60)

Code 39

< Default All Code 39 Settings >



Code 39



* On



Off

Start/Stop Characters

Start/Stop characters identify the leading and trailing ends of the bar code. You may either transmit, or not transmit Start/Stop characters. *Default = Don't Transmit.*



Transmit



* Don't Transmit

Code 39, continued

Check Character

No Check Character indicates that the scanner reads and transmits bar code data with or without a check character.

When Check Character is set to **Validate, but Don't Transmit**, the unit will only read Code 39 bar codes printed *with* a check character, but will not transmit the check character with the scanned data.

When Check Character is set to **Validate and Transmit**, the scanner will only read Code 39 bar codes printed with a check character, and will transmit this character at the end of the scanned data. *Default = No Check Character.*



* No Check Character



Validate, but Don't Transmit



Validate and Transmit

Message Length

The message length selection is used to set the valid reading length of the bar code. If the data length of the scanned bar code doesn't match the valid reading length, the scanner will issue an error beep. You may wish to set the same value for minimum and maximum length to force the scanner to read fixed length bar code data. This helps reduce the chances of a misread.

EXAMPLE: Decode only those bar codes with a count of 9-20 characters.

Min. length = 09 Max. length = 20

EXAMPLE: Decode only those bar codes with a count of 15 characters.

Min. length = 15 Max. length = 15

For a value other than the minimum and maximum message length defaults, scan the bar codes below, then scan the 2-digit value and **Save** bar codes on the Programming Chart inside the back cover. Minimum and Maximum lengths = 0-48.

Code 39, continued

Note: If you make an error while scanning the digits (before scanning **Save**), scan **Discard** on the back cover, scan the **Minimum** or **Maximum** bar code, scan the correct digits, and **Save** again.



Minimum (Default =0)



Maximum (Default =48)

Code 39 Append

This function allows the scanner to append the data from several Code 39 bar codes together before transmitting them to the host computer. When this function is enabled, the scanner stores those Code 39 bar codes that start with a space (excluding the start and stop symbols), and does not immediately transmit the data. The scanner stores the data in the order in which the bar codes are read, deleting the first space from each. The scanner transmits the appended data when it reads a Code 39 bar code that starts with a character other than a space. *Default = Off.*



On



* Off

Base 32

Base 32 is a form of the Code 39 symbology used by Italian pharmacies. This is also known as PARAF.



On



* Off

Code 39, continued

Full ASCII

If Full ASCII Code 39 decoding is enabled, certain character pairs within the bar code symbol will be interpreted as a single character. For example: \$V will be decoded as the ASCII character SYN, and /C will be decoded as the ASCII character #. Default = On.

NUL %U	DLE \$P	SP SPACE	0 0	@ %V	P P	' W	p +P
SOH \$A	DC1 \$Q	! /A	1 1	A A	Q Q	a +A	q +Q
STX \$B	DC2 \$R	" /B	2 2	B B	R R	b +B	r +R
ETX \$C	DC3 \$S	# /C	3 3	C C	S S	c +C	s +S
EOT \$D	DC4 \$T	\$ /D	4 4	D D	T T	d +D	t +T
ENQ \$E	NAK \$U	% /E	5 5	E E	U U	e +E	u +U
ACK \$F	SYN \$V	& /F	6 6	F F	V V	f +F	v +V
BEL \$G	ETB \$W	' /G	7 7	G G	W W	g +G	w +W
BS \$H	CAN \$X	(/H	8 8	H H	X X	h +H	x +X
HT \$I	EM \$Y) /I	9 9	I I	Y Y	i +I	y +Y
LF \$J	SUB \$Z	* /J	: /Z	J J	Z Z	j +J	z +Z
VT \$K	ESC %A	+ /K	; %F	K K	[%K	k +K	{ %P
FF \$L	FS %B	, /L	< %G	L L	\ %L	l +L	%Q
CR \$M	GS %C	- -	= %H	M M] %M	m +M	} %R
SO \$N	RS %D	. .	> %I	N N	^ %N	n +N	~ %S
SI \$O	US %E	/ /O	? %J	O O	_ %O	o +O	DEL %T

Character pairs /M and /N decode as a minus sign and period respectively. Character pairs /P through /Y decode as 0 through 9.



* Full ASCII On



Full ASCII Off

Interleaved 2 of 5

< *Default All Interleaved 2 of 5 Settings* >



Interleaved 2 of 5



* On



Off

Check Digit

No Check Digit indicates that the scanner reads and transmits bar code data with or without a check digit.

When Check Digit is set to **Validate, but Don't Transmit**, the unit will only read Interleaved 2 of 5 bar codes printed **with** a check digit, but will not transmit the check digit with the scanned data.

When Check Digit is set to **Validate and Transmit**, the scanner will only read Interleaved 2 of 5 bar codes printed with a check digit, and will transmit this digit at the end of the scanned data. *Default = No Check Digit.*



* No Check Digit



Validate, but Don't Transmit



Validate and Transmit

Interleaved 2 of 5, continued

Message Length

The message length selection is used to set the valid reading length of the bar code. If the data length of the scanned bar code doesn't match the valid reading length, the scanner will issue an error beep. You may wish to set the same value for minimum and maximum length to force the scanner to read fixed length bar code data. This helps reduce the chances of a misread.

EXAMPLE: Decode only those bar codes with a count of 9-20 characters.
Min. length = 09 Max. length = 20

EXAMPLE: Decode only those bar codes with a count of 15 characters.
Min. length = 15 Max. length = 15

For a value other than the minimum and maximum message length defaults, scan the bar codes below, then scan the 2-digit value and **Save** bar codes on the Programming Chart inside the back cover. Minimum and Maximum lengths = 2-80.

*Note: If you make an error while scanning the digits (before scanning Save), scan Discard on the back cover, scan the **Minimum** or **Maximum** bar code, scan the correct digits, and **Save** again.*



Minimum (Default =4)



Maximum (Default =80)

Strict Decoding

When Strict Decoding is used, the scanner only reads bar codes that are close to spec. This reduces the number of misreads, but also reduces the tolerance for bar codes that are slightly out of spec.



On



* Off

Code 93

< Default All Code 93 Settings >



Code 93



* On



Off

Message Length

The message length selection is used to set the valid reading length of the bar code. If the data length of the scanned bar code doesn't match the valid reading length, the scanner will issue an error beep. You may wish to set the same value for minimum and maximum length to force the scanner to read fixed length bar code data. This helps reduce the chances of a misread.

EXAMPLE: Decode only those bar codes with a count of 9-20 characters.
Min. length = 09 Max. length = 20

EXAMPLE: Decode only those bar codes with a count of 15 characters.
Min. length = 15 Max. length = 15

For a value other than the minimum and maximum message length defaults, scan the bar codes below, then scan the 2-digit value and **Save** bar codes on the Programming Chart inside the back cover. Minimum and Maximum lengths = 0-80.

*Note: If you make an error while scanning the digits (before scanning Save), scan Discard on the back cover, scan the **Minimum** or **Maximum** bar code, scan the correct digits, and **Save** again.*



Minimum (Default =0)



Maximum (Default =80)

Code 2 of 5

<Default All Code 2 of 5 Settings>



Code 2 of 5



* On



Off

Message Length

The message length selection is used to set the valid reading length of the bar code. If the data length of the scanned bar code doesn't match the valid reading length, the scanner will issue an error beep. You may wish to set the same value for minimum and maximum length to force the scanner to read fixed length bar code data. This helps reduce the chances of a misread.

EXAMPLE: Decode only those bar codes with a count of 9-20 characters.

Min. length = 09 Max. length = 20

EXAMPLE: Decode only those bar codes with a count of 15 characters.

Min. length = 15 Max. length = 15

For a value other than the minimum and maximum message length defaults, scan the bar codes below, then scan the 2-digit value and **Save** bar codes on the Programming Chart inside the back cover. Minimum and Maximum lengths = 1-48.

*Note: If you make an error while scanning the digits (before scanning Save), scan Discard on the back cover, scan the **Minimum** or **Maximum** bar code, scan the correct digits, and **Save** again.*



Minimum (Default =4)



Maximum (Default =48)

IATA Code 2 of 5

<Default All Code IATA 2 of 5 Settings>



IATA Code 2 of 5



* On



Off

Message Length

The message length selection is used to set the valid reading length of the bar code. If the data length of the scanned bar code doesn't match the valid reading length, the scanner will issue an error beep. You may wish to set the same value for minimum and maximum length to force the scanner to read fixed length bar code data. This helps reduce the chances of a misread.

EXAMPLE: Decode only those bar codes with a count of 9-20 characters.
Min. length = 09 Max. length = 20

EXAMPLE: Decode only those bar codes with a count of 15 characters.
Min. length = 15 Max. length = 15

For a value other than the minimum and maximum message length defaults, scan the bar codes below, then scan the 2-digit value and **Save** bar codes on the Programming Chart inside the back cover. Minimum and Maximum lengths = 1-48.

*Note: If you make an error while scanning the digits (before scanning Save), scan Discard on the back cover, scan the **Minimum** or **Maximum** bar code, scan the correct digits, and **Save** again.*



Minimum (Default =4)



Maximum (Default =48)

Matrix 2 of 5

<Default All Matrix 2 of 5 Settings>



Matrix 2 of 5



* On



Off

Message Length

The message length selection is used to set the valid reading length of the bar code. If the data length of the scanned bar code doesn't match the valid reading length, the scanner will issue an error beep. You may wish to set the same value for minimum and maximum length to force the scanner to read fixed length bar code data. This helps reduce the chances of a misread.

EXAMPLE: Decode only those bar codes with a count of 9-20 characters.
Min. length = 09 Max. length = 20

EXAMPLE: Decode only those bar codes with a count of 15 characters.
Min. length = 15 Max. length = 15

For a value other than the minimum and maximum message length defaults, scan the bar codes below, then scan the 2-digit value and **Save** bar codes on the Programming Chart inside the back cover. Minimum and Maximum lengths = 1-80.

*Note: If you make an error while scanning the digits (before scanning Save), scan Discard on the back cover, scan the **Minimum** or **Maximum** bar code, scan the correct digits, and **Save** again.*



Minimum (Default =4)



Maximum (Default =80)

Code 11

<Default All Code 11 Settings>



Code 11



Check Digits Required

This option sets whether 1 or 2 check digits are required with Code 11 bar codes.
Default = Two Check Digits.



Message Length

The message length selection is used to set the valid reading length of the bar code. If the data length of the scanned bar code doesn't match the valid reading length, the scanner will issue an error beep. You may wish to set the same value for minimum and maximum length to force the scanner to read fixed length bar code data. This helps reduce the chances of a misread.

Code 11, continued

EXAMPLE: Decode only those bar codes with a count of 9-20 characters.
Min. length = 09 Max. length = 20

EXAMPLE: Decode only those bar codes with a count of 15 characters.
Min. length = 15 Max. length = 15

For a value other than the minimum and maximum message length defaults, scan the bar codes below, then scan the 2-digit value and **Save** bar codes on the Programming Chart inside the back cover. Minimum and Maximum lengths = 1-80.

*Note: If you make an error while scanning the digits (before scanning Save), scan Discard on the back cover, scan the **Minimum** or **Maximum** bar code, scan the correct digits, and **Save** again.*



Minimum (Default =4)



Maximum (Default =80)

Code 128

<Default All Code 128 Settings>



Code 128



* On



Off

<GS> Substitution

When enabled, the scanner substitutes a <GS> for Function Character 1 when decoding EAN 128. *Default =Off.*



On



* Off

Message Length

The message length selection is used to set the valid reading length of the bar code. If the data length of the scanned bar code doesn't match the valid reading length, the scanner will issue an error beep. You may wish to set the same value for minimum and maximum length to force the scanner to read fixed length bar code data. This helps reduce the chances of a misread.

Code 128, continued

EXAMPLE: Decode only those bar codes with a count of 9-20 characters.

Min. length = 09 Max. length = 20

EXAMPLE: Decode only those bar codes with a count of 15 characters.

Min. length = 15 Max. length = 15

For a value other than the minimum and maximum message length defaults, scan the bar codes below, then scan the 2-digit value and **Save** bar codes on the Programming Chart inside the back cover. Minimum and Maximum lengths = 0-90.

*Note: If you make an error while scanning the digits (before scanning Save), scan Discard on the back cover, scan the **Minimum** or **Maximum** bar code, scan the correct digits, and **Save** again.*



Minimum (Default =0)



Maximum (Default =80)

Telepen

<Default All Telepen Settings>



Telepen



* On



Off

Telepen Output

Using AIM Telepen Output, the scanner reads symbols with start/stop pattern 1 and decodes them as standard full ASCII (start/stop pattern 1). When Original Telepen Output is selected, the scanner reads symbols with start/stop pattern 1 and decodes them as compressed numeric with optional full ASCII (start/stop pattern 2). *Default = AIM Telepen Output.*



* AIM Telepen Output



Original Telepen Output

Message Length

The message length selection is used to set the valid reading length of the bar code. If the data length of the scanned bar code doesn't match the valid reading length, the scanner will issue an error beep. You may wish to set the same value for minimum and maximum length to force the scanner to read fixed length bar code data. This helps reduce the chances of a misread.

Telepen, continued

EXAMPLE: Decode only those bar codes with a count of 9-20 characters.
Min. length = 09 Max. length = 20

EXAMPLE: Decode only those bar codes with a count of 15 characters.
Min. length = 15 Max. length = 15

For a value other than the minimum and maximum message length defaults, scan the bar codes below, then scan the 2-digit value and **Save** bar codes on the Programming Chart inside the back cover. Minimum and Maximum lengths = 1-60.

*Note: If you make an error while scanning the digits (before scanning Save), scan Discard on the back cover, scan the **Minimum** or **Maximum** bar code, scan the correct digits, and **Save** again.*



Minimum (Default =1)



Maximum (Default =60)

UPC A

<Default All UPC A Settings>



UPC A



* On



Off

Check Digit

This selection allows you to specify whether the check digit should be transmitted at the end of the scanned data or not. *Default = On.*



* On



Off

Number System

The numeric system digit of a UPC symbol is normally transmitted, but the unit can be programmed so it will not transmit it. *Default = On.*



* On



Off

UPC A, continued

Addenda

This selection adds 2 or 5 digits to the end of all scanned UPC A data.
Default = Off for both 2 Digit and 5 Digit Addenda.



2 Digit Addenda On



* 2 Digit Addenda Off



5 Digit Addenda On



* 5 Digit Addenda Off

Addenda Required

When Addenda Required is set to on, the scanner will only read UPC A bar codes that have addenda. *Default = Off.*



On



* Off

UPC A, continued

Addenda Separator

When this feature is on, there is a space between the data from the bar code and the data from the addenda. When turned off, there is no space.
Default = On.



* On



Off

UPC Strict Decoding

When UPC Strict Decoding is used, the scanner only reads bar codes that are close to spec. This reduces the number of misreads, but also reduces the tolerance for bar codes that are slightly out of spec.



On



* Off

UPC E

<Default All UPC E Settings>



UPC E0 and UPC E1

Most UPC bar codes lead with the 0 number system. For these codes, use the UPC E0 selection. If you need to read codes that lead with the 1 number system, use the UPC E1 selection. *Default = On (UPC E0) and Off (UPC E1).*



* UPC E0 On



UPC E0 Off



UPC E1 On



* UPC E1 Off

UPC E Expand

UPC E Expand expands the UPC E code to the 12 digit, UPC A format. *Default = Off.*



On



* Off

UPC E, continued

Check Digit

Check Digit specifies whether the check digit should be transmitted at the end of the scanned data or not. *Default = On.*



* On



Off

Number System

The numeric system digit of a UPC symbol is normally transmitted, but the unit can be programmed so it will not transmit it. *Default = On.*



* On



Off

UPC E, continued

Addenda

This selection adds 2 or 5 digits to the end of all scanned UPC E data.
Default = Off for both 2 Digit and 5 Digit Addenda.



2 Digit Addenda On



* 2 Digit Addenda Off



5 Digit Addenda On



* 5 Digit Addenda Off

Addenda Required

When Addenda Required is set to on, the scanner will only read UPC E bar codes that have addenda. *Default = Off.*



On



* Off

UPC E, continued

Addenda Separator

When this feature is on, there is a space between the data from the bar code and the data from the addenda. When turned off, there is no space.

Default = On.



* On



Off

EAN/JAN 13

<Default All EAN/JAN Settings>



EAN/JAN 13



* On



Off

Check Digit

This selection allows you to specify whether the check digit should be transmitted at the end of the scanned data or not. *Default = On.*



* On



Off

EAN/JAN 13, continued

Addenda

This selection adds 2 or 5 digits to the end of all scanned EAN/JAN 13 data. *Default = Off for both 2 Digit and 5 Digit Addenda.*



2 Digit Addenda On



* 2 Digit Addenda Off



5 Digit Addenda On



* 5 Digit Addenda Off

Addenda Required

When Addenda Required is set to on, the scanner will only read EAN/JAN 13 bar codes that have addenda. *Default = Off.*



On



* Off

EAN/JAN 13, continued

Addenda Separator

When this feature is on, there is a space between the data from the bar code and the data from the addenda. When turned off, there is no space.

Default = On.



ISBN Enable

This symbology allows the scanner to read ISBN codes on books. *Default = Off.*



EAN/JAN 8

<Default All EAN/JAN 8 Settings>



EAN/JAN 8



* On



Off

Check Digit

This selection allows you to specify whether the check digit should be transmitted at the end of the scanned data or not. *Default = On.*



* On



Off

EAN/JAN 8, continued

Addenda

This selection adds 2 or 5 digits to the end of all scanned EAN/JAN 8 data. *Default = Off for both 2 Digit and 5 Digit Addenda.*



2 Digit Addenda On



* 2 Digit Addenda Off



5 Digit Addenda On



* 5 Digit Addenda Off

Addenda Required

When Addenda Required is set to on, the scanner will only read EAN/JAN 8 bar codes that have addenda. *Default = Off.*



On



* Off

EAN/JAN 8, continued

Addenda Separator

When this feature is on, there is a space between the data from the bar code and the data from the addenda. When turned off, there is no space.
Default = On.



* On



Off

MSI

<Default All MSI Settings>



MSI



On



* Off

Check Character

Different types of check characters are used with MSI bar codes. You can program the scanner to read only MSI bar codes with Type 10 or Type 11 check characters. *Default = Validate Type 10, but Don't Transmit.*

When Check Character is set to **Validate and Transmit**, the scanner will only read MSI bar codes printed with the specified type check character, and will transmit this character at the end of the scanned data.

When Check Character is set to **Validate, but Don't Transmit**, the unit will only read MSI bar codes printed **with** the specified type check character, but will not transmit the check character with the scanned data.



* Validate Type 10, but Don't
Transmit



Validate Type 10 and Transmit



Validate Type 11, but Don't
Transmit



Validate Type 11 and Transmit

MSI, continued

Message Length

The message length selection is used to set the valid reading length of the bar code. If the data length of the scanned bar code doesn't match the valid reading length, the scanner will issue an error beep. You may wish to set the same value for minimum and maximum length to force the scanner to read fixed length bar code data. This helps reduce the chances of a misread.

EXAMPLE: Decode only those bar codes with a count of 9-20 characters.
Min. length = 09 Max. length = 20

EXAMPLE: Decode only those bar codes with a count of 15 characters.
Min. length = 15 Max. length = 15

For a value other than the minimum and maximum message length defaults, scan the bar codes below, then scan the 2-digit value and **Save** bar codes on the Programming Chart inside the back cover. Minimum and Maximum lengths = 4-48.

*Note: If you make an error while scanning the digits (before scanning Save), scan Discard on the back cover, scan the **Minimum** or **Maximum** bar code, scan the correct digits, and **Save** again.*



Minimum (Default =4)



Maximum (Default =48)

Plessey

<Default All Plessey Settings>



Plessey



On



* Off

Message Length

The message length selection is used to set the valid reading length of the bar code. If the data length of the scanned bar code doesn't match the valid reading length, the scanner will issue an error beep. You may wish to set the same value for minimum and maximum length to force the scanner to read fixed length bar code data. This helps reduce the chances of a misread.

EXAMPLE: Decode only those bar codes with a count of 9-20 characters.

Min. length = 09 Max. length = 20

EXAMPLE: Decode only those bar codes with a count of 15 characters.

Min. length = 15 Max. length = 15

For a value other than the minimum and maximum message length defaults, scan the bar codes below, then scan the 2-digit value and **Save** bar codes on the Programming Chart inside the back cover. Minimum and Maximum lengths = 4-48.

*Note: If you make an error while scanning the digits (before scanning Save), scan Discard on the back cover, scan the **Minimum** or **Maximum** bar code, scan the correct digits, and **Save** again.*



Minimum (Default =4)



Maximum (Default =48)

RSS-14

< Default All RSS-14 Settings >



RSS-14

Reduced Space Symbology (RSS) is a family of linear bar codes that meets restricted space requirements, while still providing full product identification.



RSS-14 Limited

< Default All RSS-14 Limited Settings >



RSS-14 Limited



RSS-14 Expanded

< *Default All RSS-14 Expanded Settings* >



RSS-14 Expanded



On



* Off

Message Length

The message length selection is used to set the valid reading length of the bar code. If the data length of the scanned bar code doesn't match the valid reading length, the scanner will issue an error beep. You may wish to set the same value for minimum and maximum length to force the scanner to read fixed length bar code data. This helps reduce the chances of a misread.

EXAMPLE: Decode only those bar codes with a count of 9-20 characters.

Min. length = 09 Max. length = 20

EXAMPLE: Decode only those bar codes with a count of 15 characters.

Min. length = 15 Max. length = 15

For a value other than the minimum and maximum message length defaults, scan the bar codes below, then scan the 2-digit value and **Save** bar codes on the Programming Chart inside the back cover. Minimum and Maximum lengths = 0-80.

*Note: If you make an error while scanning the digits (before scanning Save), scan Discard on the back cover, scan the **Minimum** or **Maximum** bar code, scan the correct digits, and **Save** again.*



Minimum (Default =4)



Maximum (Default =74)

China Post Code

<Default All China Post Code Settings>



China Post Code



On



* Off

Message Length

The message length selection is used to set the valid reading length of the bar code. If the data length of the scanned bar code doesn't match the valid reading length, the scanner will issue an error beep. You may wish to set the same value for minimum and maximum length to force the scanner to read fixed length bar code data. This helps reduce the chances of a misread.

EXAMPLE: Decode only those bar codes with a count of 9-20 characters.
Min. length = 09 Max. length = 20

EXAMPLE: Decode only those bar codes with a count of 15 characters.
Min. length = 15 Max. length = 15

For a value other than the minimum and maximum message length defaults, scan the bar codes below, then scan the 2-digit value and **Save** bar codes on the Programming Chart inside the back cover. Minimum and Maximum lengths = 0-80.

*Note: If you make an error while scanning the digits (before scanning Save), scan Discard on the back cover, scan the **Minimum** or **Maximum** bar code, scan the correct digits, and **Save** again.*



Minimum (Default =4)



Maximum (Default =80)

PDF417

Note: The following selections are for use with the 3800/3900PDF-12 scanner only.

<Default All PDF417 Settings>



PDF417



* On



Off

Message Length

The message length selection is used to set the valid reading length of the bar code. If the data length of the scanned bar code doesn't match the valid reading length, the scanner will issue an error beep. You may wish to set the same value for minimum and maximum length to force the scanner to read fixed length bar code data. This helps reduce the chances of a misread.

EXAMPLE: Decode only those bar codes with a count of 9-20 characters.

Min. length = 09 Max. length = 20

EXAMPLE: Decode only those bar codes with a count of 15 characters.

Min. length = 15 Max. length = 15

For a value other than the minimum and maximum message length defaults, scan the bar codes below, then scan the 2-digit value and **Save** bar codes on the Programming Chart inside the back cover. Minimum and Maximum lengths = 1-2750.

PDF417, continued

Note: If you make an error while scanning the digits (before scanning *Save*), scan *Discard* on the back cover, scan the **Minimum** or **Maximum** bar code, scan the correct digits, and **Save** again.



Minimum (Default =1)



Maximum (Default =2750)

Show GLI Blocks

Turning Show GLI Blocks **On** causes GLI commands to be issued where located within their encoded data sequences. When on, the “\” is used as an escape character and natural occurrences of “\” in data are replaced by “\\”.
Default = Off.



On



* Off

Scan Diagnostics

When Scan Diagnostics is turned on, the scanner sends a report instead of the decoded message. Your terminal displays the diagnostic information first, then the data from the scanned code. *Default = Off.*



On



* Off

PDF417, continued

The following list shows the information that appears for the PDF417 symbology.

Note: The higher the percentage of unused error correction (UEC), the easier it should be to read each code.

PDF 417: x rows, x cols, xx data & xx chks (ECL = x), UEC = xxx%

Rows = Number of rows

Cols = Number of columns

Data = Number of data words

Chks = Number of check words

ECL = Error Correction Level

UEC = Unused Error Correction

PDF Learn Mode

This setting tells the scanner to brighten the LED's when you have an optimal distance between the scanner and the PDF417 code you are attempting to read. Because some PDF417 codes are more compact than others, the reading distance varies from code to code. When you turn on the PDF Learn Mode, the *IT3800/3900's* light becomes very bright when you are at the best distance for reading the PDF417 code. *Default = Off.*



On



* Off

MicroPDF417

Note: The following selections are for use with the 3800/3900PDF-12 scanner only.

<Default All MicroPDF417 Settings>



MicroPDF417



On



* Off

Message Length

The message length selection is used to set the valid reading length of the bar code. If the data length of the scanned bar code doesn't match the valid reading length, the scanner will issue an error beep. You may wish to set the same value for minimum and maximum length to force the scanner to read fixed length bar code data. This helps reduce the chances of a misread.

EXAMPLE: Decode only those bar codes with a count of 9-20 characters.
Min. length = 09 Max. length = 20

EXAMPLE: Decode only those bar codes with a count of 15 characters.
Min. length = 15 Max. length = 15

For a value other than the minimum and maximum message length defaults, scan the bar codes below, then scan the 2-digit value and **Save** bar codes on the Programming Chart inside the back cover. Minimum and Maximum lengths = 1-366.

MicroPDF417, continued

*Note: If you make an error while scanning the digits (before scanning Save), scan Discard on the back cover, scan the **Minimum** or **Maximum** bar code, scan the correct digits, and **Save** again.*



Minimum (Default = 1)



Maximum (Default = 366)

EAN•UCC Composite Symbology

Note: The following selections are for use with the 3800/3900PDF-12 scanner only.

< Default All EAN•UCC Composite Symbology Settings >



EAN•UCC Composite

Linear codes are combined with a unique 2D composite component to form a new class called EAN•UCC Composite Symbology. EAN•UCC Composite Symbology allows for the co-existence of symbologies already in use.



On



*Off

Enable UPC/EAN Version

Turn on this selection to decode EAN•UCC composite symbols having a UPC or EAN primary component.



On



*Off

EAN•UCC Composite Symbology, continued

EAN•UCC Composite Symbology Message Length

The message length selection is used to set the valid reading length of the bar code. If the data length of the scanned bar code doesn't match the valid reading length, the scanner will ignore the symbol and continue scanning. You may wish to set the same value for minimum and maximum length to force the scanner to read fixed length bar code data. This helps reduce the chances of a misread.

EXAMPLE: Decode only those bar codes with a count of 9-20 characters.

Min. length = 09 Max. length = 20

EXAMPLE: Decode only those bar codes with a count of 15 characters.

Min. length = 15 Max. length = 15

For a value other than the minimum and maximum message length defaults, scan the bar codes below, then scan the appropriate value and **Save** bar codes on the Programming Chart inside the back cover. Minimum length range = 1-1000 and Maximum length range = 1-2400. Defaults are Minimum = 1, Maximum = 2400.

*If you make an error while scanning the digits (before scanning Save), scan Discard on the back cover, scan the **Minimum** or **Maximum** bar code, scan the correct digits, and **Save** again.*



Minimum (Default = 1)



Maximum (Default = 2400)



Cloning

The cloning procedure reprograms the software in the “destination” scanner’s memory with software from the “source” scanner. Before using this procedure, determine which scanner will be the source (the scanner containing the desired software). The IMAGETEAM 3800/3900 supports cloning and can act as the source device. The software in the destination scanner will be updated from the source scanner. The destination scanner device must be the same model as the source.

Procedure

1. Use the cloning cable (42204559-01) to connect the two scanners for cloning.
2. Connect the destination scanner to one of the 10 pin modular connectors on the cloning cable.
3. Connect the source scanner (containing the new or updated software) to the remaining 10 pin modular connector on the cloning cable.
4. Connect the power supply to the 4 pin mini-DIN connector located on the cloning cable or the scanner cable.
5. Make sure both units are on, and then scan the “Clone Destination” bar code with the destination scanner.



Clone Destination Bar Code

6. Scan the Clone Source bar code below with the source scanner. The scanner’s “Good Read” LED begins blinking periodically indicating cloning is in process.



Clone Source Bar Code

7. When cloning is complete, the destination scanner will double beep. This procedure takes approximately two minutes.
8. Disconnect the destination scanner from the cloning cable.
9. To clone another scanner, repeat steps 1 through 8.

Caution: DO NOT scan the "source" bar code unless you are going to clone a scanner. If you mistakenly scan this bar code, reset the scanner by turning the power off and back on to regain normal operation.

Visual Menu

Visual Menu Introduction

Visual Menu provides the ability to configure a scanning device by connecting the scanner to the com port of a PC. Visual Menu allows you to download upgrades to a scanner's firmware, change programmed parameters, and create and print programming bar codes. Using Visual Menu, you can even set up the configuration for a scanner which is not attached to your PC. This enables one expert user to establish the configuration settings for all the devices your company uses, then save these configuration files for others. A configuration file can be e-mailed or, if you prefer, an expert user can create a bar code (or series of bar codes) which contains all the customized programming parameters, and mail or fax the bar code(s) to any location. Users in other locations can scan the bar code(s) to load in the customized parameters.

To communicate with a scanner, Visual Menu requires that the PC have at least one available serial communication port and an RS-232 cable to connect the port to the device. A power supply, which plugs into the cable, is also required.

Visual Menu Operations

The Visual Menu program performs the following operations:

- Displays all configuration data, and saves the information to a file on your PC.
- Configures the device to meet your specific requirements. Visual Menu has all the programming parameters which are available via programming bar codes in this User's Guide.
- Creates and prints a clone bar code which contains the program and configuration data from one device. This bar code can then be used to program additional devices with the same parameters.
- Selects a device from a list, then performs offline or online file configuration for that device.

Temporary Visual Menu Configuration

For quick download communication configuration, scan the **Visual Menu** bar code to temporarily configure the scanner for Visual Menu settings.



Visual Menu

Installing Visual Menu from the Web

1. Access the HHP web site at www.hhp.com.
2. Click in the **Quick Search** text box and enter **Visual Menu**.
3. Click on **Search Now**.
4. Click on the entry for Visual Menu.
5. When prompted, select **Save File**, and save the files to the **c:\windows\temp** directory.
6. Once you have finished downloading the file, exit the web site.
7. Using Explorer, go to the **c:\windows\temp** file.
8. Double click on the **Visualmenu.exe** file. Follow the screen prompts to install the Visual Menu program.
9. To start Visual Menu, from the Start Menu click on **Programs, Visual Menu, Visual Menu**.

Note: If you wish, you can create a shortcut to the Visual Menu executable on your desktop.

Upgrading USB Firmware

After you use Visual Menu to upgrade your scanner's firmware, you need to scan the following bar code to upgrade the USB firmware. You must have the USB interface selected. The upgrade takes about 10 seconds, during which a busy tone is generated.



Upgrade EZUSB Firmware

Interface Keys

Keyboard Function Relationships

The following Keyboard Function Code, Hex/ASCII Value, and Full ASCII "CTRL" + relationships apply to all terminals that can be used with the scanner.

Function Code	HEX/ASCII Value	Full ASCII "CTRL" +
NUL	00	2
SOH	01	A
STX	02	B
ETX	03	C
EOT	04	D
ENQ	05	E
ACK	06	F
BEL	07	G
BS	08	H
HT	09	I
LF	0A	J
VT	0B	K
FF	0C	L
CR	0D	M
SO	0E	N
SI	0F	O
DLE	10	P
DC1	11	Q
DC2	12	R
DC3	13	S
DC4	14	T
NAK	15	U
SYN	16	V
ETB	17	W
CAN	18	X
EM	19	Y
SUB	1A	Z
ESC	1B	[
FS	1C	\
GS	1D]
RS	1E	6
US	1F	-

The last five characters in the Full ASCII "CTRL"+ column ([\]6 -), apply to US only. The following chart indicates the equivalents of these five characters for different countries.

Country	Codes				
United States	[\]	6	-
Belgium	[<]	6	-
Scandinavia	8	<	9	6	-
France	^	8	\$	6	=
Germany		Ã	+	6	-
Italy		\	+	6	-
Switzerland		<	..	6	-
United Kingdom	[¢]	6	-
Denmark	8	\	9	6	-
Norway	8	\	9	6	-
Spain	[\]	6	-

Supported Interface Keys

Supported Interface Keys		IBM AT/XT and PS/2 Compatibles, WYSE PC/AT	IBM XTs and Compatibles	IBM, DDC, Memorex Telex, Harris*
NUL	00	Reserved	Reserved	Reserved
SOH	01	Enter (KP)	CR/Enter	Enter
STX	02	Cap Lock	Caps Lock	F11
ETX	03	ALT make	Reserved	F12
EOT	04	ALT break	Reserved	F13
ENQ	05	CTRL make	Reserved	F14
ACK	06	CTRL break	Reserved	F15
BEL	07	CR/Enter	CR/Enter	New Line
BS	08	Reserved	Reserved	F16
HT	09	Tab	Tab	F17
LF	0A	Reserved	Reserved	F18
VT	0B	Tab	Tab	Tab/Field Forward
FF	0C	Delete	Delete	Delete
CR	0D	CR/Enter	CR/Enter	Field Exit/New Line
SO	0E	Insert	Insert	Insert
SI	0F	Escape	Escape	F19
DLE	10	F11	Reserved	Error Reset
DC1	11	Home	Home	Home
DC2	12	Print	Print	F20
DC3	13	Back Space	Back Space	Back Space
DC4	14	Back Tab	Back Tab	Backfield/Back Tab
NAK	15	F12	Reserved	F21
SYN	16	F1	F1	F1
ETB	17	F2	F2	F2
CAN	18	F3	F3	F3
EM	19	F4	F4	F4
SUB	1A	F5	F5	F5
ESC	1B	F6	F6	F6
FS	1C	F7	F7	F7
GS	1D	F8	F8	F8
RS	1E	F9	F9	F9
US	1F	F10	F10	F10

* IBM 3191/92, 3471/72, 3196/97, 3476/77, Telex (all models)

Supported Interface Keys

Supported Interface Keys		IBM, Memorex Telex (102)*	Memorex Telex (88)**
NUL	00	Reserved	Reserved
SOH	01	Enter	Enter
STX	02	F11	PF10
ETX	03	F12	PF11
EOT	04	F13	PF12
ENQ	05	F14	Reserved
ACK	06	F15	Reserved
BEL	07	New Line	New Line
BS	08	F16	Field Forward
HT	09	F17	Field Forward
LF	0A	F18	Reserved
VT	0B	Tab/Field Forward	Field Forward
FF	0C	Delete	Delete
CR	0D	Field Exit	New Line
SO	0E	Insert	Insert
SI	0F	Clear	Erase
DLE	10	Error Reset	Error Reset
DC1	11	Home	Reserved
DC2	12	Print	Print
DC3	13	Back Space	Back Space
DC4	14	Back Tab	Back Field
NAK	15	F19	Reserved
SYN	16	F1	PF1
ETB	17	F2	PF2
CAN	18	F3	PF3
EM	19	F4	PF4
SUB	1A	F5	PF5
ESC	1B	F6	PF6
FS	1C	F7	PF7
GS	1D	F8	PF8
RS	1E	F9	PF9
US	1F	F10	Home

* IBM 3196/97, 3476/77, 3191/92, 3471/72, Memorex Telex (all models) with 102 key keyboards

** Memorex Telex with 88 key keyboards

Supported Interface Keys

Supported Interface Keys		Esprit 200, 400 ANSI	Esprit 200, 400 ASCII	Esprit 200, 400 PC
NUL	00	Reserved	Reserved	Reserved
SOH	01	New Line	New Line	New Line
STX	02	N/A	N/A	N/A
ETX	03	N/A	N/A	N/A
EOT	04	N/A	N/A	N/A
ENQ	05	N/A	N/A	N/A
ACK	06	N/A	N/A	N/A
BEL	07	New Line	New Line	New Line
BS	08	N/A	N/A	N/A
HT	09	Tab	Tab	Tab
LF	0A	N/A	N/A	N/A
VT	0B	Tab	Tab	Tab
FF	0C	N/A	N/A	Delete
CR	0D	New Line	New Line	New Line
SO	0E	N/A	N/A	Insert
SI	0F	Escape	Escape	Escape
DLE	10	F11	F11	F11
DC1	11	Insert	Insert	Home
DC2	12	F13	F13	Print
DC3	13	Back Space	Back Space	Back Space
DC4	14	Back Tab	Back Tab	Back Tab
NAK	15	F12	F12	F12
SYN	16	F1	F1	F1
ETB	17	F2	F2	F2
CAN	18	F3	F3	F3
EM	19	F4	F4	F4
SUB	1A	F5	F5	F5
ESC	1B	F6	F6	F6
FS	1C	F7	F7	F7
GS	1D	F8	F8	F8
RS	1E	F9	F9	F9
US	1F	F10	F10	F10

Supported Interface Keys

Supported Interface Keys		Apple Mac (not iMac)
NUL	00	Reserved
SOH	01	Enter/Numpad Enter
STX	02	CAPS
ETX	03	ALT make
EOT	04	ALT break
ENQ	05	CNTRL make
ACK	06	CNTRL break
BEL	07	RETURN
BS	08	APPLE make
HT	09	TAB
LF	0A	APPLE break
VT	0B	TAB
FF	0C	Del
CR	0D	RETURN
SO	0E	Ins Help
SI	0F	ESC
DLE	10	F11
DC1	11	Home
DC2	12	Prnt Scrn
DC3	13	BACKSPACE
DC4	14	LSHIFT TAB
NAK	15	F12
SYN	16	F1
ETB	17	F2
CAN	18	F3
EM	19	F4
SUB	1A	F5
ESC	1B	F6
FS	1C	F7
GS	1D	F8
RS	1E	F9
US	1F	F10
DEL	7F	BACKSPACE

To Add a Test Code I.D. Prefix to All Symbologies

This selection allows you to turn on transmission of a Code I.D. before the decoded symbology. (See the Symbology Chart on page 4-5 for the single character code that identifies each symbology.) This action first clears all current prefixes, then programs a Code I.D. prefix for all symbologies. This is a temporary setting that will be removed when the unit is power cycled.



Add Code I.D. Prefix to
All Symbologies

Show Software Revision

Scan the bar code below to output the current software revision.



Show Revision

Show Data Format

Scan the bar code below to show current data format settings.



Data Format Settings

Specular Effect Reduction

When the **On** code is scanned, the first pass read rate and voting threshold are increased. *Default = Off.*



Note: If you want to further limit specular effects, reduce the scan speed using "Scan Rate" on page 3-1.

Default Charts

Resetting the Factory Settings

If you aren't sure what programming options are in your scanner, or you've changed some options and want the factory settings restored, scan the **Factory Default Settings** bar code below.



Factory Default Settings

The following chart lists the factory default settings (indicated by an asterisk (*) on the programming pages).

Parameter	Default Setting	Page
Terminal I.D.	003 (Model -12)	2-2
Keyboard Country	USA	2-5
Keyboard Style	Regular	2-6
Keyboard Modifiers	Control+ASCII Off	2-7
	Turbo Off	2-7
	Numeric Keypad Off	2-8
	Auto Direct Connect Off	2-8
<i>Communication (RS-232) Selections</i>		
Baud Rate	9600 bps	2-10
Word Length Data Bits	7	2-11
Word Length Stop Bits	1	2-11
Parity	Even	2-11
RS-232 Handshaking	RTS/CTS off	2-13
	XON/XOFF off	2-13
	ACK/NAK off	2-13

Parameter	Default Setting	Page
<i>Wand Emulation Selections</i>		
Wand Emulation Connection	Code 39 Format	2-14
Wand Emulation Transmission Rate	25 inches/second	2-15
Wand Emulation Polarity	Black High	2-15
Wand Emulation Idle	High	2-16
<i>PDF417 Wand Emulation Selections</i>		
Data Block Size	60	2-16
Data Between Blocks	50ms	2-17
Overall Checksum	Off	2-17
<i>Output Selections</i>		
Scan Rate	270 scans/second	3-1
Beeper Volume	High	3-1
Beeper Tone	Normal	3-2
Scan Voting	Voting Normal	3-2
Quiet Zone	Don't Reduce	3-2
Reread Delay	Short	3-3
Good Read Delay	No Delay	3-4
Trigger Mode	Manual/Serial (IT3800) Automatic (IT3900)	3-4
Serial Trigger Time Out	0 (infinite)	3-5

Parameter	Default Setting	Page
<i>Data Editing Selections</i>		
Prefix	None	4-4
Suffix	None	4-4
Function Code Transmit	Enable	4-7
Data Formatter	On/None	5-5
<i>Secondary Interface Selections</i>		
Code 39 Wand Emulation	Code 39 Format	6-1
Non Decoded Output Laser Emulation Transmission Rate	36 inches/second	6-2
Non Decoded Output Laser Emulation Polarity	White High	6-2
Non Decoded Laser Emulation Idle	High	6-3
Disabling the Secondary Interface	Disabled	6-3
Secondary Trigger Mode	Manual Trigger, Low Power Timeout 2 minutes	6-3
<i>Codabar Selections</i>		
Codabar	On	7-2
Start/Stop	Don't Transmit	7-2
Check Character	Not Required	7-3
Concatenation	On	7-4
Codabar Message Length	Min 4, Max 60	7-5
<i>Code 39 Selections</i>		
Code 39	On	7-6
Start/Stop	Don't Transmit	7-6
Check Character	Not Required	7-7

Parameter	Default Setting	Page
Code 39 Message Length	Min 0, Max 48	7-8
Code 39 Append	Off	7-8
Base 32	Off	7-8
Full ASCII	On	7-9
<i>Interleaved 2 of 5 Selections</i>		
Interleaved 2 of 5	On	7-10
Check Digit	Not Required	7-10
Interleaved 2 of 5 Message Length	Min 4, Max 80	7-11
Strict Decoding	Off	7-11
<i>Code 93 Selections</i>		
Code 93	On	7-12
Code 93 Message Length	Min 0, Max 80	7-12
<i>Code 2 of 5 Selections</i>		
Code 2 of 5	On	7-13
Code 2 of 5 Message Length	Min 4, Max 48	7-13
<i>IATA Code 2 of 5 Selections</i>		
IATA Code 2 of 5	On	7-14
IATA Code 2 of 5 Message Length	Min 4, Max 48	7-14
<i>Matrix 2 of 5 Selections</i>		
Matrix 2 of 5	On	7-15
Matrix 2 of 5 Message Length	Min 4, Max 80	7-15

Parameter	Default Setting	Page
<i>Code 11 Selections</i>		
Code 11	On	7-16
Check Digits Required	2	7-16
Message Length	Min 4, Max 80	7-17
<i>Code 128 Selections</i>		
Code 128	On	7-18
<GS> Substitution	Off	7-18
Code 128 Message Length	Min 0, Max 80	7-19
<i>Telepen Selections</i>		
Telepen	On	7-20
Telepen Output	AIM Telepen	7-20
Telepen Message Length	Min 1, Max 60	7-21
<i>UPC A</i>		
UPC A	On	7-22
Check Digit	On	7-22
Number System	On	7-22
2-Digit Addenda	Off	7-23
5-Digit Addenda	Off	7-23
Addenda Required	Off	7-23
Addenda Separator	On	7-24
UPC Strict Decoding	Off	7-24
<i>UPC E</i>		
UPC E0	On	7-25

Parameter	Default Setting	Page
UPC E1	Off	7-25
UPC E Expand	Off	7-25
Check Digit	On	7-26
Number System	On	7-26
2-Digit Addenda	Off	7-27
5-Digit Addenda	Off	7-27
Addenda Required	Off	7-27
Addenda Separator	On	7-28
<i>EAN/JAN 13</i>		
EAN/JAN 13	On	7-29
Check Digit	On	7-29
2-Digit Addenda	Off	7-30
5-Digit Addenda	Off	7-30
Addenda Required	Off	7-30
Addenda Separator	On	7-31
ISBN Enable	Off	7-31
<i>EAN/JAN 8</i>		
EAN/JAN 8	On	7-32
Check Digit	On	7-32
2-Digit Addenda	Off	7-33
5-Digit Addenda	Off	7-33
Addenda Required	Off	7-33
Addenda Separator	On	7-34

Parameter	Default Setting	Page
<i>MSI Selections</i>		
MSI	Off	7-35
Check Character	Validate Type 10, but Don't Transmit	7-35
MSI Message Length	Min 4, Max 48	7-36
<i>Plessey Selections</i>		
Plessey	Off	7-37
Plessey Message Length	Min 4, Max 48	7-37
<i>RSS-14 Selections</i>		
RSS-14	Off	7-38
RSS-14 Limited	Off	7-38
RSS-14 Expanded	Off	7-39
RSS-14 Expanded Message Length	Min 4, Max 74	7-39
<i>China Post Code</i>		
China Post Code	Off	7-40
China Post Code Message Length	Min 4, Max 80	7-40
<i>PDF417 Symbology Selections</i>		
PDF417	On	7-41
PDF417 Message Length	Min 1, Max 2750	7-42
Show GLI Blocks	Off	7-42
Scan Diagnostics	Off	7-42
PDF Learn Mode	Off	7-43

Parameter	Default Setting	Page
<i>MicroPDF417 Selections</i>		
MicroPDF417	Off	7-44
MicroPDF417 Message Length	Min 1, Max 366	7-45
<i>EAN•UCC Composite Symbology Selections</i>		
EAN•UCC Composite Symbology	Off	7-46
Enable UPC/EAN Version	Off	7-46
EAN•UCC Composite Symbology Message Length	Min 1, Max 2400	7-47

Serial Programming Commands

The serial programming commands can be used in place of the programming bar codes. Both the serial commands and the programming bar codes will program the IT3800/3900. For complete descriptions and examples of each serial programming command, refer to the corresponding programming bar code in this manual.

The device must be set to an RS-232 interface (see page 1-8). The following commands can be sent via a PC com port using terminal emulation software.

Conventions

The following conventions are used for menu and query command descriptions:

- parameter* A label representing the actual value you should send as part of a command.
- [*option*] An optional part of a command.
- {*Data*} Alternatives in a command.
- bold** Names of menus, menu commands, buttons, dialog boxes, and windows that appear on the screen.

Menu Command Syntax

Menu commands have the following syntax (spaces have been used for clarity only):

Prefix Tag SubTag {Data} [, SubTag {Data}] [: Tag SubTag {Data}] [...] Storage

- Prefix Three ASCII characters: **SYN M CR** (ASCII 22,77,13).
- Tag A 3 character case-insensitive field that identifies the desired menu command group. For example, all RS-232 configuration settings are identified with a Tag of **232**.
- SubTag A 3 character case-insensitive field that identifies the desired menu command within the tag group. For example, the SubTag for the RS-232 baud rate is **BDR**.
- Data The new value for a menu setting, identified by the Tag and Sub-Tag.

Storage A single character that specifies the storage table to which the command is applied. An exclamation point (!) performs the command's operation on the device's volatile menu configuration table. A period (.) performs the command's operation on the device's non-volatile menu configuration table. Use the non-volatile table only for semi-permanent changes you want saved through a power cycle. (The non-volatile table allows only a limited number of writes.)

Query Commands

Several special characters can be used to query the device about its settings.

- ^ What is the default value for the setting(s).
- ? What is the device's current value for the setting(s).
- * What is the range of possible values for the setting(s). (The device's response uses a dash (-) to indicate a continuous range of values. A pipe (|) separates items in a list of non-continuous values.)

Tag Field Usage

When a query is used in place of a Tag field, the query applies to the *entire* set of commands available for the particular storage table indicated by the Storage field of the command. In this case, the SubTag and Data fields should not be used because they are ignored by the device.

SubTag Field Usage

When a query is used in place of a SubTag field, the query applies only to the subset of commands available that match the Tag field. In this case, the Data field should not be used because it is ignored by the device.

Data Field Usage

When a query is used in place of the Data field, the query applies only to the specific command identified by the Tag and SubTag fields.

Concatenation of Multiple Commands

Multiple commands can be issued within one Prefix/Storage sequence. Only the Tag, SubTag, and Data fields must be repeated for each command in the sequence. If additional commands are to be applied to the same Tag, then the new command sequence is separated with a comma (,) and only the SubTag and Data fields of the additional command are issued. If the additional command requires a different Tag field, the command is separated from previous commands by a semicolon (;).

Responses

The device responds to serial commands with one of three responses:

ACK Indicates a good command which has been processed.

ENQ Indicates an invalid Tag or SubTag command.

NAK Indicates the command was good, but the Data field entry was out of the allowable range for this Tag and SubTag combination, e.g., an entry for a minimum message length of 100 when the field will only accept 2 characters.

When responding, the device echoes back the command sequence with the status character inserted directly before each of the punctuation marks (the period, exclamation point, comma, or semicolon) in the command.

Examples of Query Commands

In the following examples, a bracketed notation [] depicts a non-displayable response.

Example #1: What is the range of possible values for Codabar Coding Enable?

Enter: **cbrena*.**

Response: **CBRENA0-1[ACK]**

This response indicates that Codabar Coding Enable (CBRENA) has a range of values from 0 to 1 (off and on).

Example #2: What is the default value for Codabar Coding Enable?

Enter: **cbrena^.**

Response: **CBRENA1[ACK]**

This response indicates that the default setting for Codabar Coding Enable (CBRENA) is 1, or on.

Example #3: What is the device's current setting for Codabar Coding Enable?

Enter: **cbrena?.**

Response: **CBRENA1[ACK]**

This response indicates that the device's Codabar Coding Enable (CBRENA) is set to 1, or on.

Example #4: What are the device's settings for all Codabar selections?

Enter: **cbr?.**

Response: **CBRENA1[ACK],**
 SSX0[ACK],
 CK20[ACK],
 CCT1[ACK],
 MIN2[ACK],
 MAX60[ACK],
 DFT[ACK].

This response indicates that the device's Codabar Coding Enable (CBRENA) is set to 1, or on; the Start/Stop Character (SSX) is set to 0, or Don't Transmit; the Check Character (CK2) is set to 0, or Not Required; concatenation (CCT) is set to 1, or Enabled; the Minimum Message Length (MIN) is 2 characters; the Maximum Message Length (MAX) is 60 characters; and the Default setting (DFT) has no value.

Trigger Commands

You can activate and deactivate the scanner with serial trigger commands. First, the scanner must be put in Manual/Serial Trigger Mode either by scanning the Manual/Serial Trigger Mode bar code (page 3-4), or by sending the Manual/Serial Menu Command (page 13-8). Once the scanner is in serial trigger mode, the trigger is activated and deactivated by sending the following commands:

Activate: **SYN T CR**

Deactivate: **SYN U CR**

The scanner scans until a bar code has been read, until the deactivate command is sent, or until the serial time out has been reached (see "Serial Trigger Time Out" on page 3-5 for a description, and the serial command on page 13-8).

Menu Commands

Selection	Setting <i>* Indicates default setting</i>	Serial Command <i># Indicates a numeric entry</i>
Factory Default Settings	Default	DEFAULT
<i>Terminal Interfaces</i>		
Terminal ID		TERMID###
Program Keyboard Country		KBDCTY##
Keyboard Style	*Regular	KBDSTY0
	Caps Lock	KBDSTY1
	Shift Lock	KBDSTY2
	Emulate External Keyboard	KBDSTY5
	Automatic Caps Lock	KBDSTY6
Keyboard Modifiers	*Control + ASCII Off	KBDCAS0
	Control + ASCII On	KBDCAS1
	*Turbo Mode Off	KBDTMD0
	Turbo Mode On	KBDTMD1
	*Numeric Keypad Off	KBDNPS0
	Numeric Keypad On	KBDNPS1
	*Auto Direct Conn. Off	KBDADC0
Auto Direct Conn. On	KBDADC1	
Serial Port Connection	RS-232	PAP232
Baud Rate	300 BPS	232BAD0
	600 BPS	232BAD1
	1200 BPS	232BAD2
	2400 BPS	232BAD3
	4800 BPS	232BAD4
	*9600 BPS	232BAD5
	19200 BPS	232BAD6
	38400 BPS	232BAD7

Selection	Setting <i>* Indicates default setting</i>	Serial Command <i># Indicates a numeric entry</i>
Word Length: Data Bits, Stop Bits, and Parity	*7 Data, 1 Stop, Parity Even	232WRD3
	7 Data, 1 Stop, Parity None	232WRD0
	7 Data, 1 Stop, Parity Odd	232WRD6
	7 Data, 1 Stop, Parity Mark	232WRD12
	7 Data, 1 Stop, Parity Space	232WRD9
	7 Data, 2 Stop, Parity Even	232WRD4
	7 Data, 2 Stop, Parity None	232WRD1
	7 Data, 2 Stop, Parity Odd	232WRD7
	7 Data, 2 Stop, Parity Mark	232WRD13
	7 Data, 2 Stop, Parity Space	232WRD10
	8 Data, 1 Stop, Parity Even	232WRD5
	8 Data, 1 Stop, Parity None	232WRD2
	8 Data, 1 Stop, Parity Odd	232WRD8
	8 Data, 1 Stop, Parity Mark	232WRD14
8 Data, 1 Stop, Parity Space	232WRD11	
RS-232 Handshaking	*RTS/CTS Off	232CTS0
	RTS/CTS On	232CTS1
	*XON/XOFF Off	232XON0
	XON/XOFF On	232XON1
	*ACK/NAK Off	232ACK0
	ACK/NAK On	232ACK1
Wand Emulation Connection	Same Code Format	WNDPAT0
	*Code 39 Format	WNDPAT1
Wand Emulation Transmission Rate	10	WNDSPD0
	*25	WNDSPD1
	40	WNDSPD2
	80	WNDSPD3
	120	WNDSPD4
	150	WNDSPD5
	200	WNDSPD6
Wand Emulation Polarity	*Black High	WNDPOL0
	White High	WNDPOL1
Wand Emulation Idle	Idle Low	WNDIDL0
	*Idle High	WNDIDL1

Selection	Setting <i>* Indicates default setting</i>	Serial Command <i># Indicates a numeric entry</i>
<i>PDF417 Wand Emulation</i>		
Data Block Size	20	WNDBLK0
	40	WNDBLK1
	*60	WNDBLK2
	80	WNDBLK3
Delay Between Blocks	5ms	WNDDLY0
	*50ms	WNDDLY1
	150ms	WNDDLY2
	500ms	WNDDLY3
Overall Checksum	*Off	WNDCHK0
	On	WNDCHK1
<i>Output Selections</i>		
Scan Rate	67 s/s	SCNPFM0
	135 s/s	SCNPFM1
	*270 s/s	SCNPFM2
Beeper Volume	Off	BEPLVL0
	Low	BEPLVL1
	Medium	BEPLVL2
	*High	BEPLVL3
Beeper Tone	*Normal Beep	BEPBIP0
	Short Beep	BEPBIP1
Scan Voting	*Voting Normal	DECVLV0
	Voting High	DECVLV1
Reduce Quiet Zone	*Don't Reduce Quiet Zone	DECRQZ0
	Reduce Quiet Zone	DECRQZ1
Reread Delay	*Short	RRDDLY0
	Medium	RRDDLY1
	Long	RRDDLY2
	Extra Long	RRDDLY3
Good Read Delay	*No Delay	GRDDLY0
	Short Delay	GRDDLY1
	Medium Delay	GRDDLY2
	Long Delay	GRDDLY3

Selection	Setting <i>* Indicates default setting</i>	Serial Command <i># Indicates a numeric entry</i>
Trigger Mode	Manual/Serial Trigger	TRGMOD0
	Automatic Trigger	TRGMOD1
	Manual Trigger, Low Power	TRGMOD2
	Presentation Mode	TRGMOD3
Trigger Time Out	Serial Trigger Time Out	TRGSTO####
	Low Power Time Out	TRGLPT###
<i>Prefix/Suffix Selections</i>		
Add CR Suffix to All Symbologies		VSUFCR
Prefix	Add Prefix	PREBK2
	Clear One Prefix	PRECL2
	Clear All Prefixes	PRECA2
Suffix	Add Suffix	SUFBK2
	Clear One Suffix	SUFCL2
	Clear All Suffixes	SUFCA2
Function Code Transmit	*Enable	RMVFNC0
	Disable	RMVFNC1
Intercharacter Delay		DLYCHR##
User Specified Intercharacter Delay	Delay Length	DLYCRX##
	Character to Trigger Delay	DLY_XX##
Interfunction Delay		DLYFNC##
Intermessage Delay		DLYMSG##
<i>Data Formatter Selections</i>		
Data Format Editor	*Default Data Format (None)	DFMDF3
	Enter Format	DFMBK3
	Clear One Format	DFMCL3
	Clear All Formats	DFMCA3
Data Formatter	Off	DFM_EN0
	*On, but Not Required	DFM_EN1
	On, Required	DFM_EN2
Alternate Data Formats	1	VSAF_1
	2	VSAF_2
	3	VSAF_3

Selection	Setting <i>* Indicates default setting</i>	Serial Command <i># Indicates a numeric entry</i>
<i>Secondary Interface Selections</i>		
Wand Emulation Connection	Same Code Format	2IFTYP0
	*Code 39 Format	2IFTYP1
Secondary RS-232 Connection	RS-232 Interface	2IFTYP2
Secondary Non Decoded Output Laser Emulation	Non Decoded Output	2IFTYP3
Non Decoded Output Laser Emulation Transmission Rate	*36	HLCSPD0
	100	HLCSPD1
Non Decoded Output Laser Emulation Polarity	Black High	HLCPOL0
	*White High	HLCPOL1
Non Decoded Output Laser Emulation Idle	Low	HLCIDL0
	*High	HLCIDL1
Disabling the Secondary Interface	*Disable	2IF_EN0
	Enable	2IF_EN1
Secondary Trigger Mode	*Manual Trigger	2IFTRG0
	Automatic Trigger	2IFTRG1
	Manual Trigger, Low Power	2IFTRG2
	Low Power Time Out	2IFLPT
<i>Symbologies</i>		
All Symbologies	All Symbologies Off	ALLENA0
	All Symbologies On	ALLENA1
Codabar	Default All Codabar Settings	CBRDFT
Codabar	Off	CBRENA0
	*On	CBRENA1
Codabar Start/Stop Char.	*Don't Transmit	CBRSSX0
	Transmit	CBRSSX1
Codabar Check Char.	*No Check Char.	CBRCK20
	Validate Modulo 16, But Don't Transmit	CBRCK23
	Validate Modulo 16, and Transmit	CBRCK24
Codabar Concatatenation	Off	CBRCCT0
	*On	CBRCCT1
	Require	CBRCCT2

Selection	Setting <i>* Indicates default setting</i>	Serial Command <i># Indicates a numeric entry</i>
Codabar Message Length	Minimum	CBRMIN##
	Maximum	CBRMAX##
Code 39	Default All Code 39 Settings	C39DFT
Code 39	Off	C39ENA0
	*On	C39ENA1
Code 39 Start/Stop Char.	*Don't Transmit	C39SSX0
	Transmit	C39SSX1
Code 39 Check Char.	*No Check Char.	C39CK20
	Validate, But Don't Transmit	C39CK21
	Validate, and Transmit	C39CK22
Code 39 Message Length	Minimum	C39MIN##
	Maximum	C39MAX##
Code 39 Append	*Off	C39APP0
	On	C39APP1
Base 32	*Off	C39B320
	On	C39B321
Code 39 Full ASCII	*Off	C39ASC0
	On	C39ASC1
Interleaved 2 of 5	Default All Interleaved 2 of 5 Settings	I25DFT
Interleaved 2 of 5	Off	I25ENA0
	*On	I25ENA1
Interleaved 2 of 5 Check Digit	*No Check Char.	I25CK20
	Validate, But Don't Transmit	I25CK21
	Validate, and Transmit	I25CK22
Interleaved 2 of 5 Message Length	Minimum	I25MIN##
	Maximum	I25MAX##
Interleaved 2 of 5 Strict Decoding	*Off	I25STR0
	On	I25STR1
Code 93	Default All Code 93 Settings	C93DFT

Selection	Setting <i>* Indicates default setting</i>	Serial Command <i># Indicates a numeric entry</i>
Code 93	Off	C93ENA0
	*On	C93ENA1
Code 93 Message Length	Minimum	C93MIN##
	Maximum	C93MAX##
Code 2 of 5	Default All Code 2 of 5 Settings	R25DFT
Code 2 of 5	Off	R25ENA0
	*On	R25ENA1
Code 2 of 5 Message Length	Minimum	R25MIN##
	Maximum	R25MAX##
IATA Code 2 of 5	Default All IATA Code 2 of 5 Settings	A25DFT
IATA Code 2 of 5	Off	A25ENA0
	*On	A25ENA1
IATA Code 2 of 5 Message Length	Minimum	A25MIN##
	Maximum	A25MAX##
Matrix 2 of 5	Default All Matrix 2 of 5 Settings	X25DFT
Matrix 2 of 5	Off	X25ENA0
	*On	X25ENA1
Matrix 2 of 5 Message Length	Minimum	X25MIN##
	Maximum	X25MAX##
Code 11	Default All Code 11 Settings	C11DFT
Code 11	Off	C11ENA0
	*On	C11ENA1
Code 11 Check Digits Required	1 Check Digit	C11CK20
	*2 Check Digits	C11CK21
Code 11 Message Length	Minimum	C11MIN##
	Maximum	C11MAX##
Code 128	Default All Code 128 Settings	128DFT
Code 128	Off	128ENA0
	*On	128ENA1
<GS> Substitution	*Off	128SGS0
	On	128SGS1

Selection	Setting <i>* Indicates default setting</i>	Serial Command <i># Indicates a numeric entry</i>
Code 128 Message Length	Minimum	128MIN##
	Maximum	128MAX##
Telepen	Default All Telepen Settings	TELDFT
Telepen	Off	TELENA0
	*On	TELENA1
Telepen Output	*AIM Telepen Output	TELOLD0
	Original Telepen Output	TELOLD1
Telepen Message Length	Minimum	TELMIN##
	Maximum	TELMAX##
UPC A	Default All UPC A Settings	UPADFT
UPC A	Off	UPAENA0
	*On	UPAENA1
UPC A Check Digit	Off	UPACKX0
	*On	UPACKX1
UPC A Number System	Off	UPANSX0
	*On	UPANSX1
UPC A 2 Digit Addenda	*Off	UPAAD20
	On	UPAAD21
UPC A 5 Digit Addenda	*Off	UPAAD50
	On	UPAAD51
UPC A Addenda Required	*Off	UPAARQ0
	On	UPAARQ1
UPC A Addenda Separator	Off	UPAADS0
	*On	UPAADS1
UPC Strict Decoding	*Off	UPCSTR0
	On	UPCSTR1
UPC E	Default All UPC E Settings	UPEDFT
UPC E0	Off	UPEEN00
	*On	UPEEN01
UPC E1	*Off	UPEEN10
	On	UPEEN11
UPC E Expand	*Off	UPEEXP0
	On	UPEEXP1

Selection	Setting <i>* Indicates default setting</i>	Serial Command <i># Indicates a numeric entry</i>
UPC E Check Digit	Off	UPECKX0
	*On	UPECKX1
UPC E Number System	Off	UPENSX0
	*On	UPENSX1
UPC E 2 Digit Addenda	*Off	UPEAD20
	On	UPEAD21
UPC E 5 Digit Addenda	*Off	UPEAD50
	On	UPEAD51
UPC E Addenda Required	*Off	UPEARQ0
	On	UPEARQ1
UPC E Addenda Separator	Off	UPEADS0
	*On	UPEADS1
EAN/JAN 13	Default All EAN/ JAN 13 Settings	E13DFT
EAN/JAN 13	Off	E13ENA0
	*On	E13ENA1
EAN/JAN 13 Check Digit	Off	E13CKX0
	*On	E13CKX1
EAN/JAN 13 2 Digit Addenda	*Off	E13AD20
	On	E13AD21
EAN/JAN 13 5 Digit Addenda	*Off	E13AD50
	On	E13AD51
EAN/JAN 13 Addenda Required	*Off	E13ARQ0
	On	E13ARQ1
EAN/JAN 13 Addenda Separator	Off	E13ADS0
	*On	E13ADS1
ISBN Enable	*Off	E13ISB0
	On	E13ISB1
EAN/JAN 8	Default All EAN/ JAN 8 Settings	EA8DFT
EAN/JAN 8	Off	EA8ENA0
	*On	EA8ENA1
EAN/JAN 8 Check Digit	Off	EA8CKX0
	*On	EA8CKX1
EAN/JAN 8 2 Digit Addenda	*Off	EA8AD20
	On	EA8AD21

Selection	Setting <i>* Indicates default setting</i>	Serial Command <i># Indicates a numeric entry</i>
EAN/JAN 8 5 Digit Addenda	*Off	EA8AD50
	On	EA8AD51
EAN/JAN 8 Addenda Required	*Off	EA8ARQ0
	On	EA8ARQ1
EAN/JAN 8 Addenda Separator	Off	EA8ADS0
	*On	EA8ADS1
MSI	Default All MSI Settings	MSIDFT
MSI	*Off	MSIENA0
	On	MSIENA1
MSI Check Character	*Validate Type 10, but Don't Transmit	MSICKH0
	Validate Type 10 and Transmit	MSICKH1
	Validate Type 11, but Don't Transmit	MSICKH2
	Validate Type 11 and Transmit	MSICKH3
MSI Message Length	Minimum	MSIMIN##
	Maximum	MSIMAX##
MSI Check Digit	Transmit	MSICKX0
	*Don't Transmit	MSICKX1
Plessey	Default All Plessey Settings	PLSDFT
Plessey	*Off	PLSENA0
	On	PLSENA1
Plessey Message Length	Minimum	PLSMIN##
	Maximum	PLSMAX##
RSS-14	Default All RSS-14 Settings	RSSDFT
RSS-14	*Off	RSENA0
	On	RSENA1
RSS-14 Limited	Default All RSS-14 Limited Settings	RSLDFT
RSS-14 Limited	*Off	RSENA0
	On	RSENA1
RSS-14 Expanded	Default All RSS-14 Expanded Settings	RSEDFT

Selection	Setting <i>* Indicates default setting</i>	Serial Command <i># Indicates a numeric entry</i>
RSS-14 Expanded	*Off	RSEENA0
	On	RSEENA1
RSS-14 Expanded Msg. Length	Minimum	RSEMIN##
	Maximum	RSEMAX##
China Post Code	Default All China Post Code Settings	CPCDFT
China Post Code	*Off	CPCENA0
	On	CPCENA1
China Post Code Msg. Length	Minimum	CPCMIN##
	Maximum	CPCMAX##
PDF417	Default All PDF417 Settings	PDFDFT
PDF417	Off	PDFENA0
	*On	PDFENA1
PDF417 Message Length	Minimum	PDFMIN##
	Maximum	PDFMAX##
Show GLI Blocks	*Off	PDFGLI0
	On	PDFGLI1
Scan Diagnostics	*Off	PDFDIA0
	On	PDFDIA1
PDF Learn Mode	*Off	PDFLRN0
	On	PDFLRN1
MicroPDF417	Default All MicroPDF417 Settings	MPDDFT
MicroPDF417	*Off	MPDENA0
	On	MPDENA1
MicroPDF417 Message Length	Minimum	MPDMIN##
	Maximum	MPDMAX##
EAN•UCC Composite Symbolology	Default All EAN•UCC Composite Symbology Settings	COMDFT
EAN•UCC Composite Symbolology	*Off	COMENA0
	On	COMENA1
Enable UPC/EAN Version	*Off	COMUPC0
	On	COMUPC1
EAN•UCC Composite Symbolology Message Length	Minimum	COMMIN##
	Maximum	COMMAX##



Product Specifications

IMAGETEAM 3800 Product Specifications

<i>Parameter</i>	<i>Specification</i>
Dimensions:	
Height	6.0 inches (15.2 cm)
Length	5.3 inches (13.5 cm)
Weight	6.3 ounces (179.2 g)
Width	3.1 inches (7.9 cm)
Light Source	630 nm visible red LED
Scan Rate	Programmable to 270 scans per second
Skew Angle	±30 degrees
Pitch Angle	±15 degrees
Horizontal Velocity	2 inches (12.7 cm) per second
Minimum Reflectance Difference	30% - LR/HD, 40% - PDF
Decode Rate	270 decodes per second
Power Requirements	
-12, -13, -14 Models	5VDC ±10% at scanner
-11, -15 Models	5-12VDC ±10% at scanner
Current Draw:	<u>Scanning</u> <u>Standby</u> <u>Inrush</u> <u>Low Power</u>
-11 Model @5Vdc	400mA 200mA 550mA -----
-11 Model @12Vdc	150mA 100mA 250mA -----
-12 Model	275mA 125mA 300mA 30mA
-13 Model	275mA 125mA 250mA 60µA
-15 Model with USB Interface	500mA 265mA 1.2A -----
Temperature Ranges:	
Operating	32° F to +122° F (0° C to +50° C)
Storage	-4° F to +140° F (-20° C to +60° C)
Humidity	0 to 95% non-condensing
Mechanical Shock	Operational after 25 drops from 5 feet (1.53 m) to concrete
Vibration	Withstands 5G peak from 20 to 300 Hz
ESD Sensitivity	15 kV to any external surface

Agency Compliance	FCC Class B, CE EMC Class B, CE Low Voltage Directive, EN60825-1, IEC60825-1 LED Safety: Class 1, UL, cUL, TÜV Certified to EN60950, C-Tic
-------------------	--

IMAGETEAM 3900 Product Specifications

<i>Parameter</i>	<i>Specification</i>
Dimensions:	
Height	1.5 inches (3.8 cm)
Length	4.7 inches (11.9 cm)
Width	3.1 inches (7.9 cm)
Light Source	630 nm visible red LED
Scan Rate	Programmable to 270 scans per second
Skew Angle	±30 degrees
Pitch Angle	±15 degrees
Horizontal Velocity	2 inches (12.7 cm) per second
Minimum Reflectance Difference	30% (3900 Linear), 40% (3900PDF)
Decode Rate	270 decodes per second
Power Requirements	5 VDC ±10% at scanner
Current Draw	<u>Scanning</u> <u>Standby</u> <u>Low Power</u>
@270 s/s	275 mA 125 mA 30 mA
@67 s/s	150 mA 125 mA 30 mA
Temperature Ranges:	
Operating	32° to +122° F (0° to +50° C)
Storage	-4° to +140° F (-20° to +60° C)
Humidity	0 to 95% non-condensing
Mechanical Shock	Operational after 5 drops from 5 feet (1.53 m) to concrete
Vibration	Withstands 5G peak from 20 to 300 Hz
ESD Sensitivity	15 kV to any external surface
Agency Compliance	FCC Class B, CE EMC Class B, CE Low Voltage Directive, IEC60825-1 LED Safety: Class 1, UL, cUL listed, TÜV

Standard Cable Pinouts

Laser Output Only (Laser Compatible Bar Image)

Conventional laser data format is provided at the modular connector in the scanner handle. The interface cable is terminated with a 10 pin modular plug, and a 9 pin Type D (squeeze to release) connector that is compatible with all HHP's terminals.

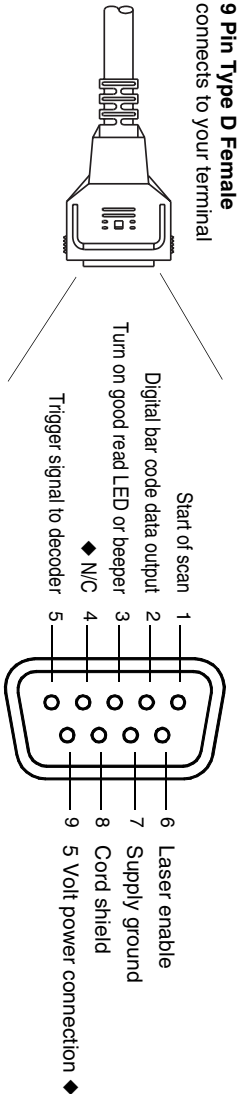
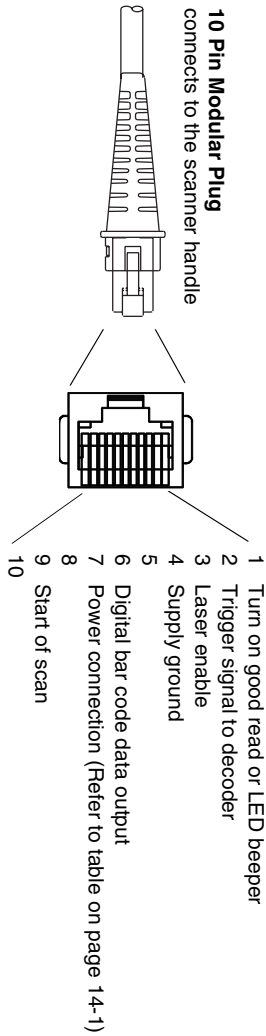

◆ Pins 4 and 9 are populated depending on power supply voltage option.
Some decoders may have +12V on pins 4 or 9. **Connect to +5VDC ONLY!**

Standard Cable Pinouts

Keyboard Wedge

Decoded output data format provided at 10 pin RJ41 modular connector (in scanner handle).

10 Pin RJ41 Modular Plug
connects to the scanner handle

1) IT3800-11, -15 Power Connection (Refer to table on page 14-1)

2 Cord shield

3 Prog 1

4 Supply ground

5 Terminal clock

6 Terminal data

7 Power connection (Refer to table on page 14-1)

8 Keyboard data

9 Keyboard clock

10

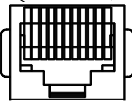

Standard Cable Pinouts

Wand Emulation

Decoded output data format provided at 10 pin RJ41 modular connector (in scanner handle).

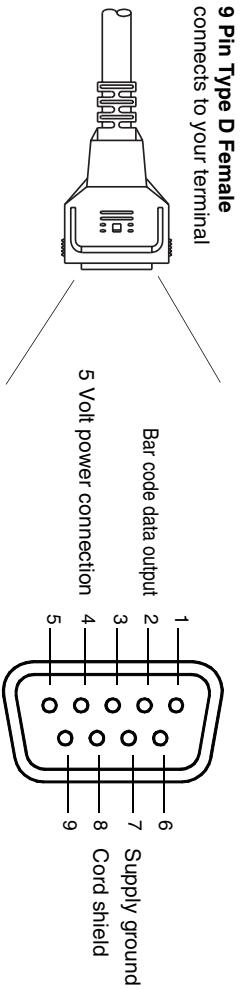
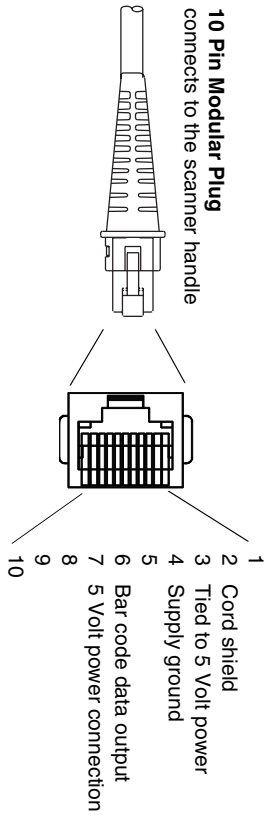

Standard Cable Pinouts (Primary Interface Cables)

Serial Output

Decoded output data format provided at 10 pin RJ41 modular connector (in scanner handle).

10 Pin RJ41 Modular Plug
connects to the scanner handle

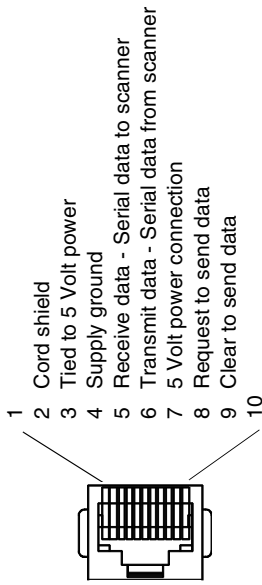

Standard Cable Pinouts
USB

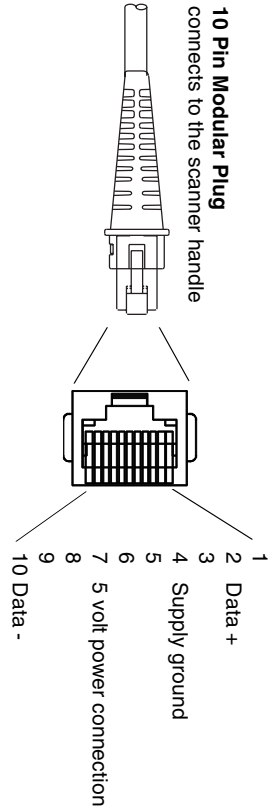

Scan Maps

Typical performance at 20°C for IT3800LR-11, -12, -13 reading good quality linear bar codes

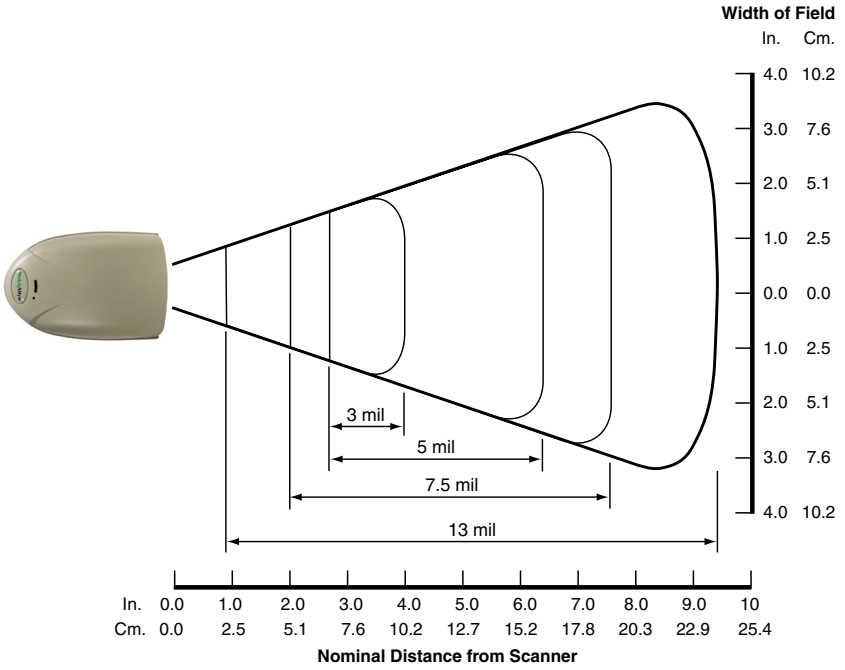

Typical performance at 20°C for IT3800VHD-12 reading good quality linear bar codes

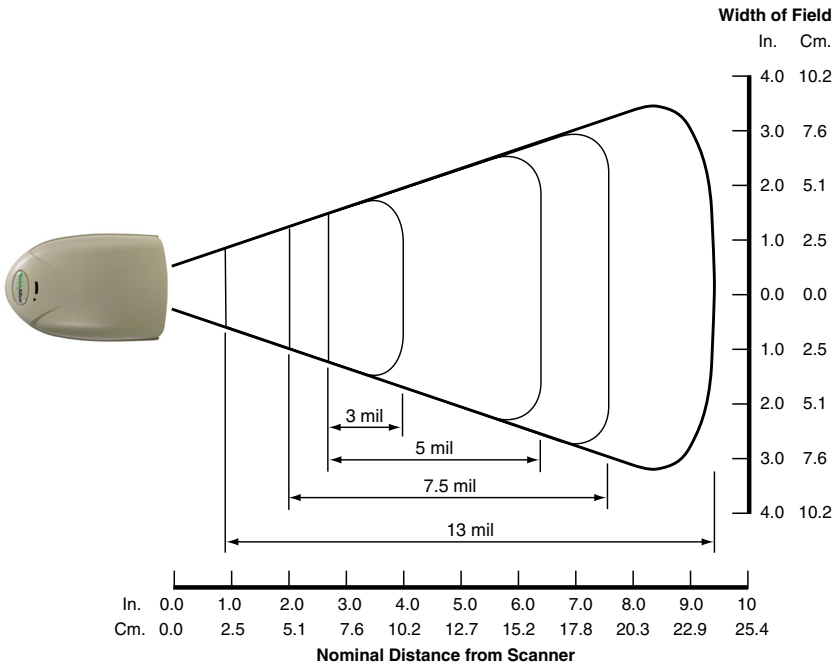

Typical performance at 20°C for IT3800PDF-12 reading good quality, 3:1 aspect ratio PDF417 bar codes

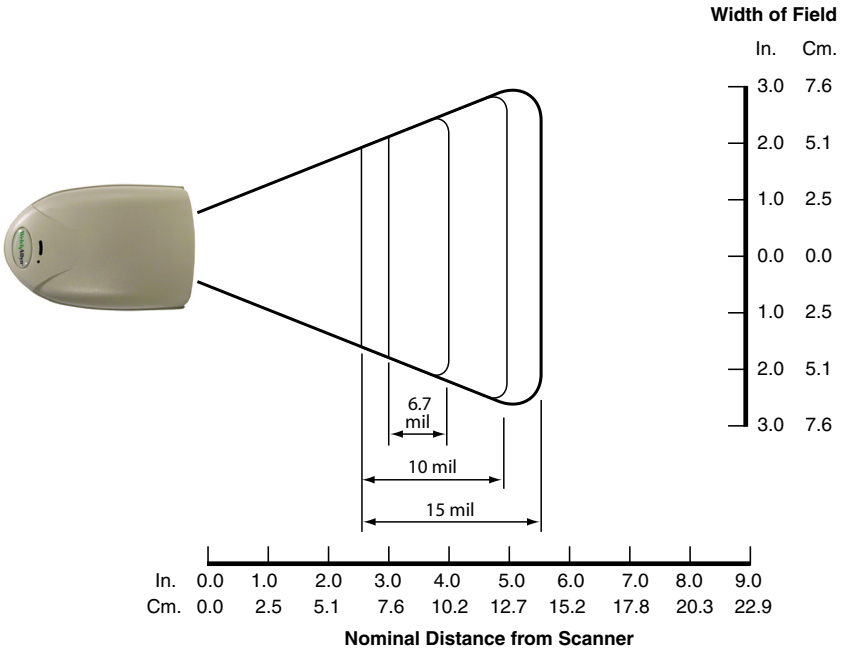

Typical performance at 20°C for IT3800PDF-12 reading good quality linear bar codes

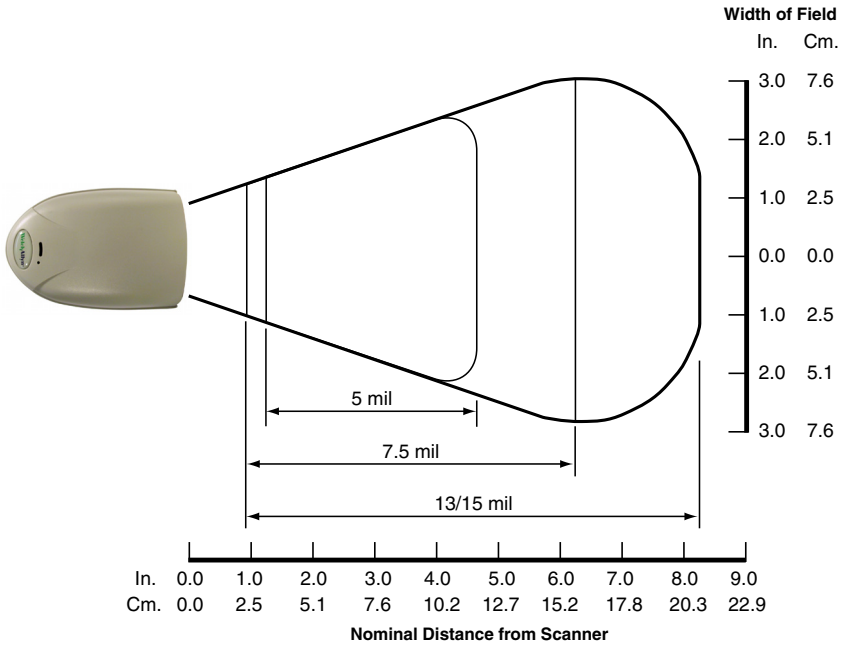

Typical performance at 20°C for IT3800LX reading good quality bar codes

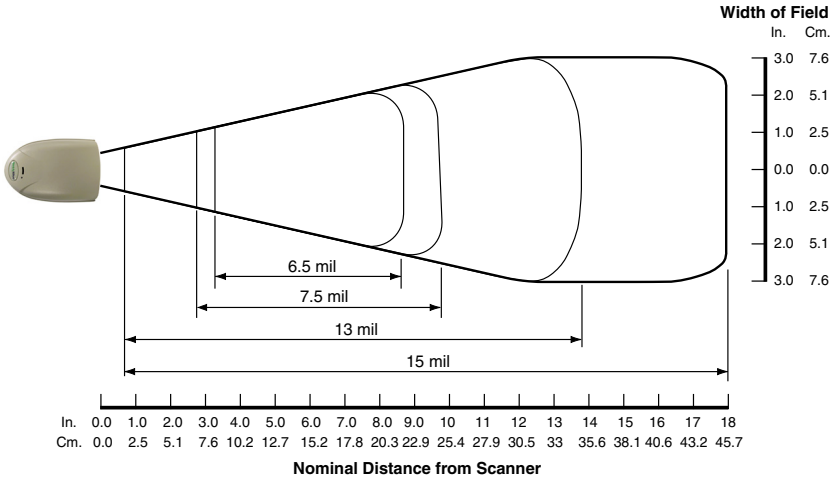

Refer to page 1-5 for the IMAGETEAM 3900 scan map and mounting diagram.

Maintenance

Repairs

Repairs and/or upgrades are not to be performed on this product. These services are to be performed only by an authorized service center. See "Customer Support" on page 16-1 for further information.

Maintenance

The IMAGETEAM 3800/3900 provides reliable and efficient operation with a minimum of care. Although specific maintenance is not required, the following periodic checks ensure dependable scanner operation:

Cleaning the Scanner's Window

Reading performance may degrade if the scanner's window is not clean. If the window is visibly dirty, or if the scanner isn't operating well, clean the window with a soft cloth or facial tissue dampened with water (or a mild detergent- water solution). If a detergent solution is used, rinse with a clean tissue dampened with water only.

The scanner's housing may also be cleaned the same way.



Caution:

Do not submerge the scanner in water. The scanner's housing is not water-tight.

Do not use abrasive wipers or tissues on the scanner's window - abrasive wipers may scratch the window.

Never use solvents (alcohol or acetone) on the housing or window - solvents may damage the finish or the window.

Inspecting Cords and Connectors

Inspect the scanner's interface cable and connector for wear or other signs of damage. A badly worn cable or damaged connector may interfere with scanner operation. Contact your HHP distributor for information about cable replacement. Cable replacement instructions are on page 15-2.

Replacing the Interface Cable

The standard interface cable is attached to the scanner with an 10-pin modular connector. When properly seated, the connector is held in the IT3800 scanner's handle by a flexible retention tab. The IT3900 connector is located in the pod at the end of the IT3900 cable. The interface cable is designed to be field replaceable.

- Order replacement cables from HHP or from an authorized distributor.
- When ordering a replacement cable, specify the cable part number of the original interface cable.

To Replace the Interface Cable:

1. Turn the power to the host system OFF.
2. Disconnect the scanner's cable from the terminal or computer.
3. Locate the small hole on the side of the scanner's handle (IT3800), or on the underside of the connector pod (IT3900). This is the cable release.
4. Straighten one end of a paper clip.
5. Insert the end of the paper clip into the small hole and press in. This depresses the retention tab, releasing the connector. Pull the connector out while maintaining pressure on the paper clip, then remove the paper clip.
6. Replace with the new cable. Insert the connector into the opening and press firmly. The connector is keyed to go in only one way, and will click into place.

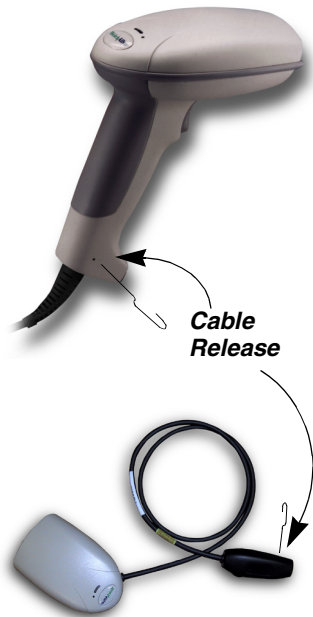

Troubleshooting

The scanner automatically performs self-tests whenever you turn it on. If your scanner is not functioning properly, review the following Troubleshooting Guide to try to isolate the problem.

Is the power on? Is the red illumination beam on?

If the red illumination beam isn't illuminated, check that:

-
1. The cable is connected properly.
 2. The host system power is on (if external power isn't used).
 3. The trigger works.

Is the scanner having trouble reading your symbols?

If the scanner isn't reading symbols well, check that the symbols:

1. Aren't smeared, rough, scratched, or exhibiting voids.
2. Aren't coated with frost or water droplets on the surface.
3. Are enabled in the scanner or in the decoder to which the scanner connects.

Is the bar code displayed but not entered?

The bar code is displayed on the host device correctly, but you still have to press a key to enter it (the Enter/Return key or the Tab key, for example).

You need to program a suffix. Programming a suffix enables the scanner to output the bar code data plus the key you need (such as "CR") to enter the data into your application. Refer to "Prefix/Suffix Overview" on page 4-1 for further information.

Does the scanner read the bar code incorrectly?

If the scanner reads a bar code, but the data is not displayed correctly on the host screen:

1. The scanner may not be programmed for the appropriate terminal interface. For example, you scan "12345" and the host displays "@es%."

Reprogram the scanner with the correct Plug and Play or Terminal selection bar code. See Chapter 1 and Chapter 2.
2. The scanner may not be programmed to output your bar code data properly. For example, you scan "12345" and the host displays "A12345B."

Reprogram the scanner with the proper symbology selections. See Chapter 7.

The scanner won't read your bar code at all.

1. Scan the sample bar codes in the back of this manual. If the scanner reads the sample bar codes, check that your bar code is readable. Verify that your bar code symbology is enabled (see Chapter 7).
2. If the scanner still can't read the sample bar codes, scan "All Symbologies" on page 7-1.

If you aren't sure what programming options have been set in the scanner, or if you want the factory default settings restored, scan "Factory Default Settings" on page 12-1.

Application Support

If you are still experiencing problems, call your Distributor
or HHP:

**315-685-2476 or (800) 782-4263 in North
America**

8 a.m. to 6 p.m. EST

Fax: 315-685-4960

Web Site: www.hhp.com

E-Mail: support@hhp.com



Customer Support

Obtaining Factory Service

HHP provides service for all its products through service centers located in Charlotte, North Carolina, Hong Kong, the Netherlands, and the United Kingdom. To obtain warranty or non-warranty service, return the unit to HHP (postage paid) with a copy of the dated purchase record attached.

In the United States, please contact the HHP Product Service Department at the address/telephone number listed below to obtain a Return Material Authorization number (RMA #) before returning the product.

HHP Service Department

7510 E. Independence Blvd.
Suite 200
Charlotte, NC 28227
Telephone: (800) 782-4263 Fax: (704) 566-9904

For service in Europe, please contact your HHP representative (at the address that follows) or your local distributor.

European Office Hand Held Products, Inc.

Nijverheidsweg 9
5627 BT Eindhoven
The Netherlands

Telephone: +31(0) 40 29 01 600
Fax: + 31 (0) 40 24 25 672

United Kingdom Office Hand Held Products, Inc.

Dallam Court
Dallam Lane
Warrington
Cheshire WA2 7LT
United Kingdom

Telephone: +44 (0) 1 925 240055
or +353 1 216 0070
Fax: +44 (0) 1 925 631280
or +353 1 295 6353

For service in Asia, please contact your HHP representative (at the address that follows) or your local distributor.

Asia/Pacific Office
Hand Held Products, Inc.

10/F Tung Sun Commercial Centre
194-200 Lockhart Road
Wanchai, Hong Kong

Telephone: +852-2511-3050 *or* 2511-3132
Fax: +852-251-1355

For service in Japan, please contact your HHP representative (at the address that follows) or your local distributor.

Japan Office
Hand Held Products, Inc.

Bon Marusan 8F
3-5-1 Kanda-Jinbocho
Chiyoda-ku
Tokyo 101, Japan

Telephone: +81-3-5212-7392
Fax: +81-3-3261-7372

For service in Latin America, please contact your HHP representative (at the address that follows) or your local distributor.

Latin America Office
Hand Held Products, Inc.

5117 Castello Drive
Suite 1
Naples, FL 34103

Telephone: (239) 263-7600
Fax: (239) 263-9689

Help Desk

If you need assistance installing or troubleshooting your scanner, please call your Distributor or the nearest HHP technical support office:

North America:

Telephone: (315) 685-2476 (8 a.m. to 8 p.m. EST)
or in the U.S. (800) 782-4263
Fax number: (315) 685-4960
E-mail: tech_support@hhp.com

Europe:

Telephone-
European Ofc: + 31(0) 40 29 01 600
U.K. Ofc: +44 1925 240055
E-mail: euro_support@hhp.com

Asia:

Telephone: +852-2511-3050 or 2511-3132
E-mail: asia_support@hhp.com

Latin America:

Telephone: (56) 2 942-2495 or (56) 2 942-8371
E-mail: la_support@hhp.com

Limited Warranty

Hand Held Products, Inc., d/b/a HHP ("HHP") warrants its products to be free from defects in materials and workmanship and to conform to HHP's published specifications applicable to the products purchased at the time of shipment. This warranty does not cover any HHP product which is (i) improperly installed or used; (ii) damaged by accident or negligence, including failure to follow the proper maintenance, service, and cleaning schedule; or (iii) damaged as a result of (A) modification or alteration by the purchaser or other party, (B) excessive voltage or current supplied to or drawn from the interface connections, (C) static electricity or electro-static discharge, (D) operation under conditions beyond the specified operating parameters, or (E) repair or service of the product by anyone other than HHP or its authorized representatives.

This warranty shall extend from the time of shipment for the duration published by HHP for the product at the time of purchase ("Warranty Period"). Any defective product must be returned (at purchaser's expense) during the Warranty Period to HHP's factory or authorized service center for inspection. No product will be accepted by HHP without a Return Materials Authorization, which may be obtained by contacting HHP. In the event that the product is returned to HHP or its authorized service center within the Warranty Period and HHP determines to its satisfaction that the product is defective due to defects in materials or workmanship, HHP, at its sole option, will either repair or replace the product without charge, except for return shipping to HHP.

EXCEPT AS MAY BE OTHERWISE PROVIDED BY APPLICABLE LAW, THE FOREGOING WARRANTY IS IN LIEU OF ALL OTHER COVENANTS OR WARRANTIES, EITHER EXPRESSED OR IMPLIED, ORAL OR WRITTEN, INCLUDING, WITHOUT LIMITATION, ANY IMPLIED WARRANTIES OF MERCHANTABILITY OR FITNESS FOR A PARTICULAR PURPOSE.

HHP'S RESPONSIBILITY AND PURCHASER'S EXCLUSIVE REMEDY UNDER THIS WARRANTY IS LIMITED TO THE REPAIR OR REPLACEMENT OF THE DEFECTIVE PRODUCT. IN NO EVENT SHALL HHP BE LIABLE FOR INDIRECT, INCIDENTAL, OR CONSEQUENTIAL DAMAGES, AND, IN NO EVENT, SHALL ANY LIABILITY OF HHP ARISING IN CONNECTION WITH ANY PRODUCT SOLD HEREUNDER (WHETHER SUCH LIABILITY ARISES FROM A CLAIM BASED ON CONTRACT, WARRANTY, TORT, OR OTHERWISE) EXCEED THE ACTUAL AMOUNT PAID TO HHP FOR THE PRODUCT. THESE LIMITATIONS ON LIABILITY SHALL REMAIN IN FULL FORCE AND EFFECT EVEN WHEN HHP MAY HAVE BEEN ADVISED OF THE POSSIBILITY OF SUCH INJURIES, LOSSES, OR DAMAGES. SOME STATES, PROVINCES, OR COUNTRIES DO NOT ALLOW THE EXCLUSION OR LIMITATIONS OF INCIDENTAL OR CONSEQUENTIAL DAMAGES, SO THE ABOVE LIMITATION OR EXCLUSION MAY NOT APPLY TO YOU.

All provisions of this Limited Warranty are separate and severable, which means that if any provision is held invalid and unenforceable, such determination shall not affect the validity of enforceability of the other provisions hereof.

The limited duration of the warranty for the IMAGETEAM 3800/3900 is for five (5) years.

Sample Symbols

UPC A



0 123456 7890

Interleaved 2 of 5

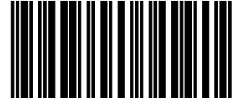

1234567890

Code 128



Code 128

EAN 13



9 780330 290951

Code 39

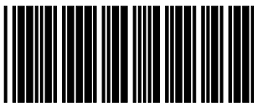

BC321

Codabar

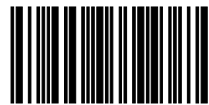

A13579B

Sample Symbols

PDF417



PDF417 Test Message

MicroPDF417



MicroPDF417 Test Message

Code 93

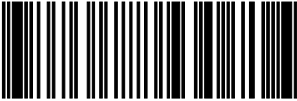

123456-9\$

Code 2 of 5

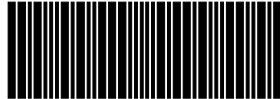

123456

Matrix 2 of 5



6543210

RSS-14



(01)00123456789012

EAN•UCC Composite Symbology with RSS Limited



(01)12345678901231(10)123456789(11)001205(3202)001234

Programming Chart



0



2



4



6



8



1



3



5



7



9

Programming Chart



A



B



C



D



E



F



Save



Discard



Upgrade your image.

700 Visions Drive

P.O. Box 208

Skaneateles Falls, NY 13153-0208