



2020/4820/4820i
2D Cordless Imaging System



User's Guide

Disclaimer

Hand Held Products, Inc. ("Hand Held Products") reserves the right to make changes in specifications and other information contained in this document without prior notice, and the reader should in all cases consult Hand Held Products to determine whether any such changes have been made. The information in this publication does not represent a commitment on the part of Hand Held Products.

Hand Held Products shall not be liable for technical or editorial errors or omissions contained herein; nor for incidental or consequential damages resulting from the furnishing, performance, or use of this material.

This document contains proprietary information which is protected by copyright. All rights are reserved. No part of this document may be photocopied, reproduced, or translated into another language without the prior written consent of Hand Held Products.

© 2005-2006 **Hand Held Products, Inc.** All rights reserved.

Web Address: www.handheld.com

Microsoft® Pocket PC 2002, Windows®, Windows NT®, Windows 2000, Windows ME, Windows XP, ActiveSync®, Outlook®, and the Windows logo are trademarks or registered trademarks of Microsoft Corporation.

The Bluetooth® word mark and logos are owned by Bluetooth SIG, Inc.

Statement of Agency Compliance

The 2020/4820/4820i system meets or exceeds the requirements of all applicable standards organizations for safe operation. However, as with any electrical equipment, the best way to ensure safe operation is to operate them according to the agency guidelines that follow. Please read these guidelines carefully before using your 2020/4820/4820i system.

Regulatory and Safety Approvals for the 2020/4820/4820i

Parameter	Specification
USA	FCC Part 15, Class B
Canada	ICES-003
European Community	EN 55022 (CISPR 22) Class B EN60950 EN60825-1 EN55024:1998

FCC Class B Compliance Statement

This device complies with part 15 of the FCC Rules. Operation is subject to the following two conditions:

1. This device may not cause harmful interference.
2. This device must accept any interference received, including interference that may cause undesired operation.

This equipment has been tested and found to comply with the limits for a Class B digital device pursuant to part 15 of the FCC Rules. These limits are designed to provide reasonable protection against harmful interference in a residential installation. This equipment generates, uses, and can radiate radio frequency energy and, if not installed and used in accordance with the instructions, may cause harmful interference to radio communications. If this equipment does cause harmful interference to radio or television reception, which can be determined by turning the equipment off and on, the user is encouraged to try to correct the interference by one or more of the following measures:

- Reorient or relocate the receiving antenna.
 - Increase the separation between the equipment and receiver.
 - Connect the equipment into an outlet on a circuit different from that to which the receiver is connected.
 - Consult the dealer or an experienced radio or television technician for help.
-

If necessary, the user should consult the dealer or an experienced radio/television technician for additional suggestions. The user may find the following booklet helpful: "Something About Interference." This is available at FCC local regional offices. Hand Held Products, Inc. is not responsible for any radio or television interference caused by unauthorized modifications of this equipment or the substitution or attachment of connecting cables and equipment other than those specified by Hand Held Products, Inc. The correction is the responsibility of the user. Use only shielded data cables with this system.

In accordance with FCC 15.21, changes or modifications not expressly approved by the party responsible for compliance could void the user's authority to operate the equipment.



This device and its antenna must not be co-located or operating in conjunction with any other antenna or transmitter. To maintain compliance with FCC RF exposure guidelines for body-worn operation, do not use accessories that contain metallic components and ensure that the device is at least 15mm (0.6 inches) from the body.

Canadian Compliance

This Class B digital apparatus complies with Canadian ICES-003. Operation is subject to the following two conditions:

1. This device may not cause harmful interference.
2. This device must accept any interference received, including interference that may cause undesired operation.
3. To prevent radio interference to the licensed service, this device is intended to be operated indoors and away from windows to provide maximum shielding. Equipment (or its transmit antenna) that is installed outdoors is subject to licensing.

Cet appareil numérique de la Classe B est conforme à la norme NMB-003 du Canada.

CE Compliance



The CE mark on the product indicates that the system has been tested to and conforms with the provisions noted within the 89/336/EEC Electromagnetic Compatibility Directive and the 73/23/EEC Low Voltage Directive.

Complies with:

- EN55022:1998 (for ITE emissions)
 - EN55024:1998 (for ITE immunity), including CISPR 22B:1997
 - EN61000-4-2:1995
 - EN61000-4-3:1995
-

For CE-related inquiries, please contact:

Hand Held Products
Nijverheidsweg 9-13
5627 BT Eindhoven
The Netherlands

Hand Held Products shall not be liable for use of our product with equipment (i.e., power supplies, personal computers, etc.) that is not CE marked and does not comply with the Low Voltage Directive.

Regulatory Approvals for Bluetooth Radio Devices

RF devices are designed to comply with the most current applicable standards on safe levels of RF energy developed by the Institute of Electrical and Electronics Engineers (IEEE) and the American National Standards Institute (ANSI) and have been recommended for adoption by the Federal Communications Commission (FCC).

Parameter	Specification
RF Approvals	
U.S.A.	FCC Part 15.247
Canada	RSS 210

Bluetooth Radio Device R&TTE Compliance Statement

The 2020 and 4820/4820i are in conformity with all essential requirements of the R&TTE Directive (1999/5/EC). This equipment has been assessed to the following standards:

Parameter	Specification
R&TTE	EN 300 328-2:2000 EN 301 489-1 (2002-08) EN 301 489-17 (2002-08) EN 60950:2000

This product is marked with **CE0682** in accordance with the product requirements specified in the R&TTE Directive, 1999/5/EC.

The equipment is intended for use throughout the European Community.

Bluetooth Qualified Product



Bluetooth Qualified Body approved as a Bluetooth Class II radio.

UL and cUL Statement

UL and cUL listed: UL60950-1 and CSA C22.2 No.60950-1-03.

CB Scheme

Tested and conforms to IEC 60950.

LED Safety Statement

This device has been tested in accordance with IEC60825-1 LED safety, and has been certified to be under the limits of a Class 1 LED device.

TÜV Statement

TÜV or GS marked to EN60950 and EN60825-1.

C-Tick Statement

Conforms to AS/NZS 3548. C-Tick number: N10410.

Mexico



Patents

Please refer to the 4820/4820i packaging for patent information.

Solids and Water Protection

The 2020 and 4820 have ratings of IP41, immunity of foreign particles and dripping water.

The 4820i has a rating of IP54, immunity of foreign particles and sprayed water.

For European Community Users

Hand Held Products complies with Directive 2002/69/EC OF THE EUROPEAN PARLIAMENT AND OF THE COUNCIL of 27 January 2003 on waste electrical and electronic equipment (WEEE).

Waste Electrical and Electronic Equipment Information

This product has required the extraction and use of natural resources for its production. It may contain hazardous substances that could impact health and the environment, if not properly disposed.

In order to avoid the dissemination of those substances in our environment and to diminish the pressure on the natural resources, we encourage you to use the appropriate take-back systems for product disposal. Those systems will reuse or recycle most of the materials of the product you are disposing in a sound way.



The crossed out wheeled bin symbol informs you that the product should not be disposed of along with municipal waste and invites you to use the appropriate separate take-back systems for product disposal.

If you need more information on the collection, reuse, and recycling systems, please contact your local or regional waste administration.

You may also contact your supplier for more information on the environmental performances of this product.

Required Safety Labels

4820



4820i



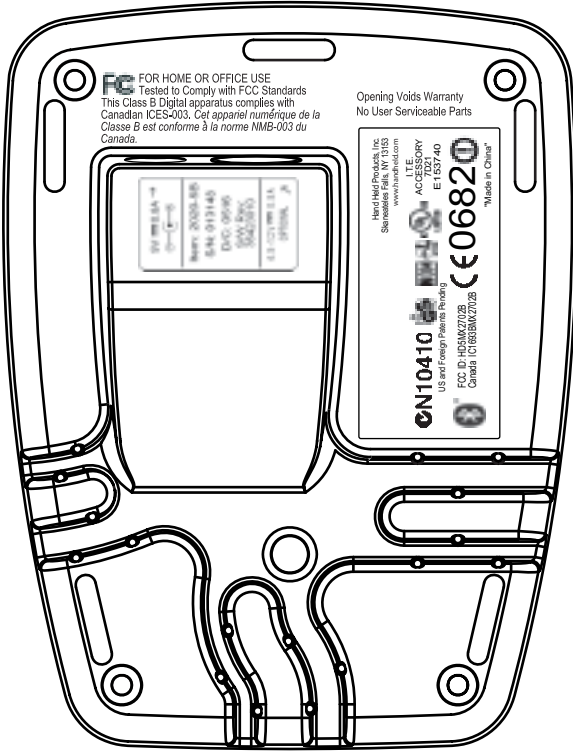



Table of Contents

Chapter 1 - Getting Started

About This Manual	1-1
Unpacking the System	1-1
Imager Models	1-1
Cordless System: Main Components	1-2
About the Battery	1-2
Proper Disposal of the Battery	1-3
Connecting the Base	1-3
Connecting the Base with USB	1-4
Connecting the Base with Keyboard Wedge	1-4
Connecting the Base with RS-232 Serial Port	1-6
Connecting the Base with Serial Wedge	1-6
Linking Imager to Base	1-7
Communication Between the Cordless System and the Host	1-8
Reading Techniques	1-9

Chapter 2 - Programming the Interface

Introduction	2-1
Programming the Interface - Plug and Play	2-1
Keyboard Wedge Connection	2-1
Laptop Direct Connect	2-1
RS-232	2-2
Wand Emulation Plug & Play	2-2
IBM 4683 Ports 5B, 9B, and 17 Interface	2-3
IBM SurePos	2-4
USB PC or Macintosh Keyboard	2-5
USB HID	2-5
USB Com Port Emulation	2-6
Serial Wedge	2-7
Programming the Interface - Terminal ID Method	2-7
Supported Terminals	2-8
Keyboard Country	2-10
Keyboard Style	2-12

Keyboard Modifiers.....	2-13
RS-232 Baud Rate.....	2-15
RS-232 Word Length: Data Bits, Stop Bits, and Parity.....	2-16
RS-232 Receiver Time-Out.....	2-17
RS-232 Handshaking	2-17
Host ACK Selection.....	2-18
Host ACK Enable.....	2-19
Wand Emulation	2-21
Wand Emulation Connection	2-21
Wand Emulation Data Block Size.....	2-21
Wand Emulation Delay Between Blocks.....	2-22
Wand Emulation Overall Checksum.....	2-22
Wand Emulation Transmission Rate.....	2-23
Wand Emulation Polarity.....	2-23
Wand Emulation Idle	2-24

Chapter 3 - Basic System Operation

Cordless Base.....	3-1
RF (Radio Frequency) Module Operation.....	3-1
Cordless Imager.....	3-1
System Conditions	3-2
Linking Process.....	3-2
Imager Is Out of Range	3-2
Imager Is Moved Back Into Range	3-2
Out of Range and Back into Range with Data Accumulation Mode On.....	3-2
Base Charge Mode.....	3-3
Beeper and LED Sequences and Meaning.....	3-4
Imager LED Sequences and Meaning.....	3-4
2020 LED Sequences and Meaning	3-4
Imager Modes	3-5
Unlinking the Imager	3-5
Single Imager Operation.....	3-5
Locked Link Mode - Single Imager	3-6
Open Link Mode - Single Imager	3-6
Override Locked Imager	3-6

Multiple Imager Operation	3-7
Imager Name.....	3-8
Imager Report	3-9
Application Work Groups.....	3-9
Application Work Group Selection.....	3-10
Resetting the Standard Product Default Settings: All	
Application Work Groups	3-11
Resetting the Standard Product Default Settings:	
Current Application Work Group.....	3-11
Using the Imager with Bluetooth Devices	3-12
Changing Bluetooth PIN Code.....	3-12
Out-of-Range Alarm	3-13
Duration.....	3-13
Alarm Sound Type	3-13
Data Accumulation Mode.....	3-14

Chapter 4 - Output

Good Read Indicators	4-1
Beeper – Good Read.....	4-1
Beeper Volume – Good Read.....	4-1
Beeper Pitch – Good Read	4-2
Beeper Duration – Good Read	4-2
LED – Good Read	4-2
Number of Beeps – Good Read.....	4-3
Good Read Delay	4-3
User-Specified Good Read Delay	4-3
Serial Trigger Modes	4-4
Manual/Serial Trigger, Low Power.....	4-4
Scan Stand Mode	4-6
Scan Stand Symbol.....	4-6
Presentation Mode	4-6
Presentation LED Behavior after Decode	4-7
Presentation Sensitivity	4-7
Hands Free Time-Out	4-7
Reread Delay.....	4-8
User-Specified Reread Delay.....	4-8

LED Power Level	4-9
Illumination Lights	4-9
Aimer Delay.....	4-10
User-Specified Aimer Delay	4-10
Aimer Mode.....	4-10
Centering.....	4-11
Decode Search Mode	4-13
Output Sequence Overview	4-14
Output Sequence Editor	4-16
Require Output Sequence.....	4-16
Multiple Symbols	4-17
No Read	4-17
Print Weight.....	4-18
Video Reverse.....	4-18
Working Orientation.....	4-19

Chapter 5 - Data Editing

Prefix/Suffix Overview.....	5-1
To Add a Prefix or Suffix:	5-2
To Clear One or All Prefixes or Suffixes:.....	5-3
To Add a Carriage Return Suffix to all Symbologies	5-3
Prefix Selections.....	5-4
Suffix Selections	5-4
Function Code Transmit.....	5-4
Intercharacter, Interfunction, and Intermesage Delays	5-5
Intercharacter Delay	5-5
User Specified Intercharacter Delay	5-6
Interfunction Delay	5-6
Intermesage Delay	5-7

Chapter 6 - Data Formatting

Data Format Editor Introduction.....	6-1
To Add a Data Format.....	6-1
Other Programming Selections	6-2
Data Format Editor Commands.....	6-2
Data Format Editor	6-4
Data Formatter.....	6-5
Alternate Data Formats	6-5

Chapter 7 - Symbologies

All Symbologies	7-2
Message Length Description.....	7-2
Codabar	7-3
Codabar Start/Stop Characters.....	7-3
Codabar Check Character.....	7-3
Codabar Concatenation	7-4
Codabar Message Length	7-5
Code 39	7-5
Code 39 Start/Stop Characters.....	7-6
Code 39 Check Character.....	7-6
Code 39 Message Length	7-7
Code 39 Append.....	7-7
Code 32 Pharmaceutical (PARAF)	7-8
Full ASCII	7-8
Code 39 Code Page	7-9
Interleaved 2 of 5	7-9
Check Digit.....	7-10
Interleaved 2 of 5 Message Length	7-10
Code 93	7-11
Code 93 Message Length	7-11
Code 93 Code Page	7-12
Straight 2 of 5 Industrial (three-bar start/stop)	7-12
Straight 2 of 5 Industrial Message Length	7-13
Straight 2 of 5 IATA (two-bar start/stop)	7-13
Straight 2 of 5 IATA Message Length	7-14

Matrix 2 of 5	7-14
Matrix 2 of 5 Message Length	7-15
Code 11	7-15
Check Digits Required	7-16
Code 11 Message Length	7-16
Code 128	7-16
ISBT 128 Concatenation	7-17
Code 128 Message Length	7-17
Code 128 Code Page	7-18
Telepen	7-18
Telepen Output	7-19
Telepen Message Length	7-19
UPC-A	7-19
UPC-A Check Digit	7-20
UPC-A Number System	7-20
UPC-A Addenda	7-21
UPC-A Addenda Required	7-21
UPC-A Addenda Separator	7-21
UPC-A/EAN-13	
with Extended Coupon Code	7-22
UPC-E0	7-22
UPC-E0	7-22
UPC-E0 Expand	7-23
UPC-E0 Addenda Required	7-23
UPC-E0 Addenda Separator	7-23
UPC-E0 Check Digit	7-24
UPC-E0 Number System	7-24
UPC-E0 Addenda	7-24
UPC-E1	7-25
EAN/JAN-13	7-25
EAN/JAN-13 Check Digit	7-26
EAN/JAN-13 Addenda	7-26
EAN/JAN-13 Addenda Required	7-26
EAN/JAN-13 Addenda Separator	7-27
ISBN Translate	7-27

EAN/JAN-8	7-27
EAN/JAN-8 Check Digit.....	7-28
EAN/JAN-8 Addenda.....	7-28
EAN/JAN-8 Addenda Required.....	7-29
EAN/JAN-8 Addenda Separator	7-29
MSI	7-29
MSI Check Character	7-30
MSI Message Length.....	7-30
Plessey Code	7-30
Plessey Message Length.....	7-31
RSS-14	7-31
RSS Limited	7-32
RSS Expanded	7-32
RSS Expanded Message Length.....	7-33
PosiCode	7-33
PosiCode Message Length	7-34
Trioptic Code	7-34
Codablock F	7-35
Codablock F Message Length.....	7-35
Code 16K	7-35
Code 16K Message Length	7-36
Code 49	7-36
Code 49 Message Length	7-37
PDF417	7-37
PDF417 Message Length	7-38
MicroPDF417	7-38
MicroPDF417 Message Length.....	7-39
EAN•UCC Composite Codes	7-39
UPC/EAN Version	7-39
EAN•UCC Composite Code Message Length	7-40

EAN•UCC Emulation	7-40
TCIF Linked Code 39 (TLC39)	7-41
Postal Codes	7-41
4-CB (4-State Customer Bar Code)	7-41
ID-tag (UPU 4-State)	7-41
Postnet	7-42
Planet Code	7-42
British Post	7-43
Canadian Post	7-43
Kix (Netherlands) Post	7-43
Australian Post	7-43
Japanese Post	7-44
China Post	7-45
China Post Message Length	7-45
Korea Post	7-46
Korea Post Message Length	7-46
QR Code	7-47
QR Code Message Length	7-47
Data Matrix	7-48
Data Matrix Message Length	7-48
MaxiCode	7-49
MaxiCode Message Length	7-49
Aztec Code	7-50
Aztec Code Message Length	7-50
Aztec Runes	7-51

Chapter 8 - Imaging Commands

Image Snap - IMGSNP	8-1
IMGSNP Modifiers	8-1
Image Ship - IMGSHIP	8-2
IMGSHIP Modifiers	8-3
Image Size Compatibility	8-6
Intelligent Signature Capture - IMGBOX	8-7
IMGBOX Modifiers	8-7
RF Default Imaging Device	8-9

Chapter 9 - OCR Programming

OCR Fonts	9-1
OCR	9-1
U.S. Currency Font	9-2
MICR E13 B Font	9-2
SEMI Font	9-3
OCR Templates.....	9-3
Creating an OCR Template	9-4
Stringing Together Multiple Formats (Creating “Or” Statements)	9-6
OCR User-Defined Variables	9-7
Reading Multi-Row OCR.....	9-7
OCR Check Character.....	9-8
OCR Modulo 10 Check Character	9-9
OCR Modulo 36 Check Character	9-9
OCR User-Defined Check Character.....	9-9
Weighting Options	9-10
OCR ISBN Application Example	9-12
OCR Template Codes	9-13

Chapter 10 - Interface Keys

Keyboard Function Relationships.....	10-1
Supported Interface Keys.....	10-3

Chapter 11 - Utilities

To Add a Test Code I.D. Prefix to All Symbologies	11-1
Show Decoder Revision.....	11-1
Show Engine Revision	11-1
Show Scan Driver Revision	11-1
Show Software Revision.....	11-2
Show Data Format	11-2
Reset Imager	11-2
Imager Report	11-2
Imager Address	11-2
Base Address.....	11-3

Resetting the Standard Product Default Settings:	
Current Application Work Group	11-3
Resetting the Standard Product Default Settings: All	
Application Work Groups	11-3
Test Menu	11-4
Visual Xpress	11-4
Installing Visual Xpress from the Web	11-5
Quick*View	11-5
Installing Quick*View from the Web	11-6

Chapter 12 - Serial Programming Commands

Conventions	12-1
Menu Command Syntax	12-1
Query Commands.....	12-2
Concatenation of Multiple Commands	12-2
Responses	12-3
Examples of Query Commands	12-3
Trigger Commands	12-4
Menu Commands.....	12-5
Programming the Interface	12-5
Basic System Operation	12-8
Output Selections	12-9
Prefix/Suffix Selections	12-11
Data Formatter Selections	12-12
Symbologies	12-12
Imaging Default Commands	12-21
Image Snap	12-21
Image Snap (continued)	12-22
OCR Selections	12-24

Chapter 13 - Product Specifications

4820 Product Specifications	13-1
4820i Product Specifications	13-2
2020 Product Specifications	13-3

Chapter 14 - Maintenance

Repairs	14-1
Maintenance	14-1
Cleaning the Imager's Window	14-1
Inspecting Cords and Connectors	14-1
Replacing the 2020 Interface Cable:	14-2
Assembling the Battery Charge Sleeve Kit	14-3
Troubleshooting Base	14-4

Chapter 15 - Customer Support

Product Service and Repair	15-1
Online Product Service and Repair Assistance	15-2
Technical Assistance	15-2
Online Technical Assistance	15-3
Limited Warranty	15-3

Appendix A

Symbology Chart	A-1
ASCII Conversion Chart (Code Page 1252)	A-4
Code Page Mapping of Printed Bar Codes	A-6



About This Manual

This User's Guide provides installation and programming instructions for the 4820/4820i. Product specifications, dimensions, warranty, and customer support information are also included.

Hand Held Products bar code imagers are factory programmed for the most common terminal and communications settings. If you need to change these settings, programming is accomplished by scanning the bar codes in this guide.

An asterisk (*) next to an option indicates the default setting.

Unpacking the System

After you open the shipping carton containing the product, take the following steps:

- Check for damage during shipment. Report damage immediately to the carrier who delivered the carton.
- Make sure the items in the carton match your order.
- Save the shipping container for later storage or shipping.

Imager Models

Models	Description
4820SF0C1CBE	Cordless Area Imager, Green aimer, Special Focus
4820SR0C1CBE	Cordless Area Imager, Green aimer, Standard Range
4820ISFE	Industrial Cordless Area Imager, Green aimer, Special Focus
4820ISRE	Industrial Cordless Area Imager, Green aimer, Standard Range
2020-5BE	Cordless Base that supports the following interfaces: Keyboard wedge, TTL level 232, TTL level 232 serial wedge, IBM 4683, wand emulation, USB keyboard, USB HID, USB retail (IBM Sure-POS)
2020-CB	Charge-Only Base

Cordless System: Main Components



About the Battery



Use only the Li-ion battery packs provided by Hand Held Products. The use of any battery pack not sold by Hand Held Products will void your warranty and may result in damage to your unit.

Power is supplied to the cordless imager by a rechargeable battery that is integrated in the imager handle. Each imager is shipped with a battery. (See [Product Specifications](#) beginning on page 13-1.)

Charging Information

The battery is designed to charge while the imager is positioned in the cordless base unit. Refer to "[2020 LED Sequences and Meaning](#)" on page 3-4 for an interpretation of the Charge Status indicators.

- Place the imager in the base that is connected to an appropriate power supply.

Battery Recommendations

- Batteries are shipped approximately 30% to 60% charged and should be fully charged for maximum charge capacity.

-
- The battery is a lithium ion cell and can be used without a full charge, as well as can be charged without fully discharging, without impacting the battery life. There is no need to perform any charge/discharge conditioning on this cell type battery.
 - Do not disassemble the battery. There are no user-serviceable parts in the battery.
 - Keep the base connected to power when the host is not in use.
 - Replace a defective battery immediately since it could damage the imager.
 - Don't short-circuit a battery or throw it into a fire. It can explode and cause severe personal injury.
 - Although your battery can be recharged many times, it will eventually be depleted. Replace it after the battery is unable to hold an adequate charge.
 - If you are not sure if the battery or charger is working properly, send it to Hand Held Products or an authorized Hand Held Products service center for inspection.

Proper Disposal of the Battery



When the battery has reached the end of its useful life, the battery should be disposed of by a qualified recycler or hazardous materials handler. Do not incinerate the battery or dispose of the battery with general waste materials. You may send batteries to Hand Held Products (postage paid). The shipper is responsible for complying with all federal, state, and local laws and regulations related to the packing, labeling, manifesting, and shipping of spent batteries. Contact the

Product Service Department ([page 15-1](#)) for recycling or disposal information. Since you may find that your cost of returning the batteries significant, it may be more cost effective to locate a local recycle/disposal company.

Connecting the Base

A base can be connected between the keyboard and PC as a “keyboard wedge,” plugged into the serial port, plugged into a USB port, or connected to a portable data terminal in wand emulation or non decoded output mode.

Turn off power before connecting the base, then power up the computer once the base is fully connected. When the base is connected and powered up, put the imager in the base to establish a link. The green LED on the base flashes to indicate the imager's battery is charging.

Connecting the Base with USB

A base can be connected to the USB port of a computer.

1. Connect the appropriate interface cable to the base first and then to the computer.

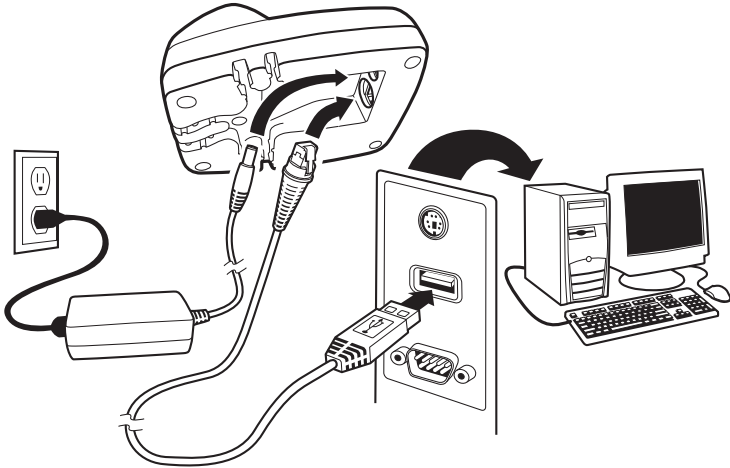

2. Program the base for the USB interface by scanning the appropriate programming bar code See [page 2-5](#).
3. Verify the base operation by scanning a bar code from the [Sample Symbols](#) in the back of this manual.

For additional USB programming and technical information, refer to the Hand Held Products “USB Application Note,” available at www.handheld.com.

Connecting the Base with Keyboard Wedge

1. Turn off power and disconnect the keyboard cable from the back of the terminal/computer.

-
2. Connect the appropriate interface cable to the base and to the terminal/ computer and keyboard.

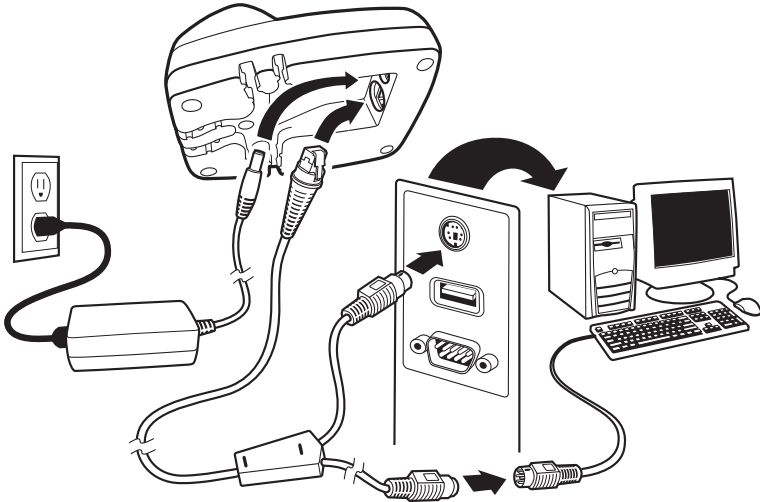

3. Turn the terminal/computer power back on.
4. Program the base for the keyboard wedge interface. See "[Keyboard Wedge Connection](#)" on page 2-1.
5. Verify the base operation by scanning a bar code from the [Sample Symbols](#) in the back of this manual.

Connecting the Base with RS-232 Serial Port

1. Turn off power to the terminal/computer.
2. Connect the appropriate interface cable to the base.

Note: For the base to work properly, you must have the correct cable for your type of terminal/computer.

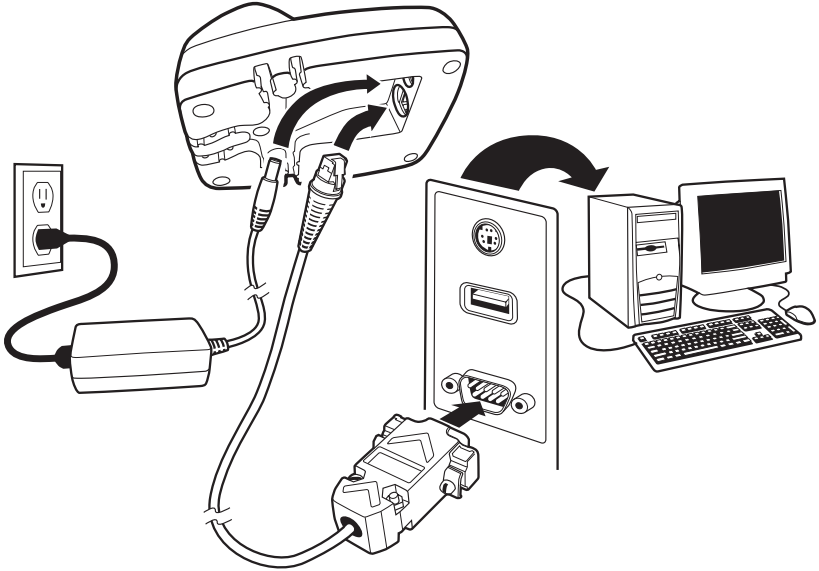

3. Plug the serial connector into the serial port on your computer. Tighten the two screws to secure the connector to the port.
4. Once the imager has been fully connected, power up the computer.

Connecting the Base with Serial Wedge

The 2020 uses TTL signal levels to wedge into an RS-232 serial network. Use only 2020 serial wedge cables to prevent damage to the base. Refer to [RS-232 Baud Rate](#) on page 2-15 to set the baud rate and communications protocol.

1. Turn off power to the computer.
2. Disconnect the existing serial cable from the computer.
3. Connect the appropriate interface cable to the base.

Note: For the base to work properly, you must have the correct cable for your type of computer.

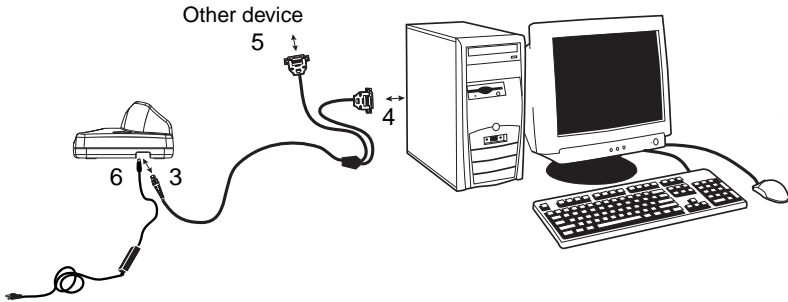

4. Plug the serial connector into the serial port on your computer. Tighten the two screws to secure the connector to the port.
5. Plug the other serial connector into the other device connection and tighten the two screws.
6. Plug the power supply barrel connector to the base, and plug the power supply into the AC source.
7. Once the base has been fully connected, power up the computer.

Linking Imager to Base

When newly shipped or defaulted to factory settings, the base and imager are not linked. Once the imager is placed into the base, the software automatically links the imager and the base. If the imager and base have previously been linked, you do not receive any feedback. If this is the first time that the imager and base are linked, both devices emit a short chirp when their radios link. At this point, you are set to one imager to one base.



1. Provide power to the base.
2. Place the imager into the base. The imager and base link.
3. To determine if your cordless system is set up correctly, scan one of the sample bar codes in the back of this manual. If the imager provides a single good read beep and the green LED lights, the imager has successfully linked to the base. If you receive a triple error beep and the red LED lights, the imager has not linked to the base. Refer to [page 14-4](#) for troubleshooting information.

Communication Between the Cordless System and the Host

The cordless imager provides immediate feedback in the form of a “good read” indication (a green LED on the imager and an audible beep) after a bar code is scanned correctly and the base has acknowledged receiving the data. This is possible since the cordless system provides two-way communication between the imager and the base.

When data is scanned, the data is sent to the host system via the base unit. The cordless imager recognizes data acknowledgement (ACK) from the base unit. If it cannot be determined that the data has been properly sent to the base, the imager issues an error indication. You must then check to see if the scanned data was received by the host system.

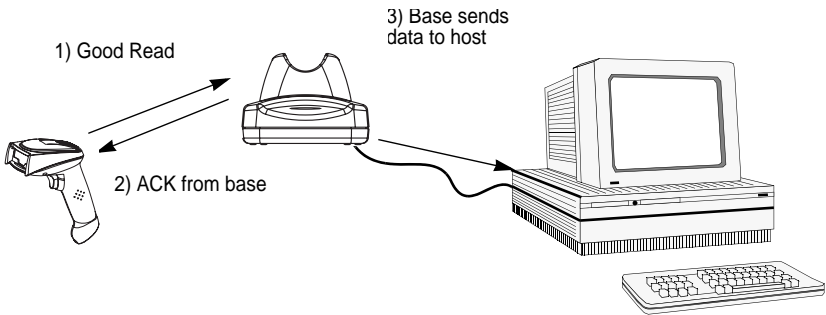

Reading Techniques

The imager has a view finder that projects a bright green aiming beam that corresponds to the imager's horizontal field of view. The aiming beam should be centered over the bar code, but it can be positioned in any direction for a good read.

Linear bar code

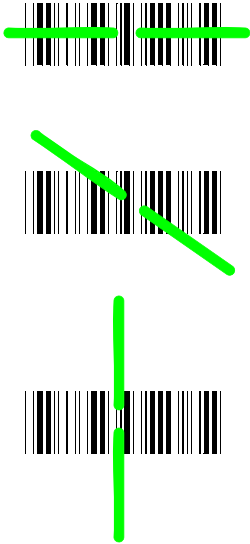

2D Matrix symbol

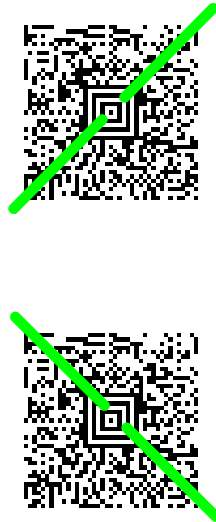

The aiming beam is smaller when the imager is closer to the code and larger when it is farther from the code. Symbologies with smaller bars or elements (mil size) should be read closer to the unit. Symbologies with larger bars or elements (mil size) should be read farther from the unit. To read single or multiple symbols (on a page or on an object), hold the imager at an appropriate distance from the target, pull the trigger, and center the aiming beam on the symbol. If the code being scanned is highly reflective (e.g., laminated), it may be necessary to tilt the code up 15° to 18° to prevent unwanted reflection.



Programming the Interface

Introduction

Chapter 1 describes connecting the base to the computer with the appropriate interface cable. This chapter describes how to program your system for the desired interface.

Programming the Interface - Plug and Play

Plug and Play bar codes provide instant imager set up for commonly used interfaces.

Note: After you scan one of the codes, power cycle the host terminal to have the interface in effect.

Keyboard Wedge Connection

If you want your system programmed for an IBM PC AT and compatibles keyboard wedge interface with a USA keyboard, scan the bar code below. Keyboard wedge is the default interface.

Note: The following bar code also programs a carriage return (CR) suffix.



IBM PC AT and Compatibles
with CR suffix

Laptop Direct Connect

For most laptops, scanning the **Laptop Direct Connect** bar code allows operation of the imager in parallel with the integral keyboard. The following Laptop Direct Connect bar code selects terminal ID 03, programs a carriage return (CR) suffix and turns on Emulate External Keyboard ([page 2-13](#)).



Laptop Direct Connect
with CR suffix

RS-232

The RS-232 Interface bar code is used when connecting to the serial port of a PC or terminal. The following RS-232 Interface bar code also programs a carriage return (CR) and a line feed (LF) suffix, baud rate, and data format as indicated below. It also changes the trigger mode to manual.

Option	Setting
Baud Rate	115200 bps
Data Format	8 data bits, no parity bit, 1 stop bit



RS-232 Interface

Wand Emulation Plug & Play

In Wand Emulation mode, the imager decodes the bar code then sends data in the same format as a scanner imager. The Code 39 Format converts all symbologies to Code 39.

The Same Code Format transmits UPC, EAN, Code 128 and Interleaved 2 of 5 without any changes, but converts all other symbologies to Code 39.

The **Wand Emulation Plug & Play Code 39 Format** bar code below sets the terminal ID to 61. The **Wand Emulation Plug & Play Same Code Format** bar code sets the terminal ID to 64. These Plug & Play bar codes also set the Transmission Rate to 25 inches per second, Output Polarity to black high, and Idle State to high. (If you want to change the terminal ID *only*, without changing any other imager settings, please refer to [Programming the Interface - Terminal ID Method](#) on page 2-7.)



Wand Emulation
Plug & Play
(Code 39 Format)



Wand Emulation
Plug & Play
Same Code

IBM 4683 Ports 5B, 9B, and 17 Interface

Scan one of the following “Plug and Play” codes to program the imager for IBM 4683 Port 5B, 9B, or 17.

Note: After scanning one of these codes, you must power cycle the cash register.



IBM 4683 Port 5B Interface



IBM 4683 Port 17 Interface



IBM 4683 Port 9B
HHBCR-1 Interface



IBM 4683 Port 9B
HHBCR-2 Interface

Each bar code above also programs the following suffixes for each symbology:

Symbology	Suffix
EAN 8	0C
EAN 13	16
UPC A	0D
UPC E	0A
Code 39	00 0A 0B
Interleaved 2 of 5	00 0D 0B
Code 128 *	00 0A 0B
Code 128 **	00 18 0B

* Suffixes programmed for Code 128 with IBM 4683 Port 5B, IBM 4683 Port 9B HHBCR-1, and IBM 4683 Port 17 Interfaces

**Suffixes programmed for Code 128 with IBM 4683 Port 9 HHBCR-2 Interface

IBM SurePos

Scan one of the following “Plug and Play” codes to program the imager for IBM SurePos (USB Hand Held imager) or IBM SurePos (USB Tabletop imager).

Note: After scanning one of these codes, you must power cycle the cash register.



IBM SurePos
(USB Hand Held Imager)
Interface



IBM SurePos
(USB Tabletop Imager)
Interface

Each bar code above also programs the following suffixes for each symbology:

Symbology	Suffix
EAN 8	0C
EAN 13	16
UPC A	0D
UPC E	0A
Code 39	00 0A 0B
Interleaved 2 of 5	00 0D 0B
Code 128	00 18 0B

USB PC or Macintosh Keyboard

Scan one of the following codes to program the imager for USB PC Keyboard or USB Macintosh Keyboard. Scanning these codes adds a CR and LF, along with selecting the terminal ID (USB PC Keyboard - 124, USB Macintosh Keyboard - 125, USB PC Japanese Keyboard - 134).



USB Keyboard (PC)



USB Keyboard (Mac)



USB Japanese Keyboard (PC)

USB HID

Scan the following code to program the imager for USB HID bar code imagers. Scanning this code changes the terminal ID to 131.



USB HID Bar Code Imager

USB Com Port Emulation

Scan the following code to program the imager to emulate a regular RS-232-based Com Port. If you are using a Microsoft® Windows® PC, you will need to download a driver from the Hand Held Products website (www.handheld.com). The driver will use the next available Com Port number. Apple® Macintosh computers recognize the imager as a USB CDC class device and automatically uses a class driver. Scanning the code below changes the terminal ID to 130.



USB COM Port Emulation

Note: No extra configuration (e.g., baud rate) is necessary.

CTS/RTS Emulation



CTS/RTS Emulation On



* CTS/RTS Emulation Off

ACK/NAK Mode



ACK/NAK Mode On



* ACK/NAK Mode Off

Serial Wedge

To set up the serial wedge terminal ID, use the serial terminal ID 050 and follow the instructions on [page 2-7](#). Make sure that all of the communication parameters match on all of the connected devices. Choosing Both sends scanned data to P1 and P2. Default = P1.



* P1



P2



Both P1 and P2

Programming the Interface - Terminal ID Method

If your interface is not a standard PC AT, refer to [Supported Terminals](#), beginning on page 2-8, and locate the Terminal ID number for your PC. Scan the **Terminal ID** bar code below, then scan the numeric bar code(s) from the [Programming Chart](#) inside the back cover of this manual to program the imager for your terminal ID. Scan **Save** to save your selection.

For example, an IBM AT terminal has a Terminal ID of 003. You would scan the **Terminal ID** bar code, then **0, 0, 3** from the [Programming Chart](#) inside the back cover of this manual, then **Save**. If you make an error while scanning the digits (before scanning Save), scan the **Discard** code on the [Programming Chart](#), scan the **Terminal ID** bar code, scan the digits, and the **Save** code again.

Note: The default interface is Keyboard Wedge (Term ID = 003).



Terminal ID



Save

Note: After scanning one of these codes, you must power cycle your computer.

Supported Terminals

<u>Terminal</u>	<u>Model(s)</u>	<u>Terminal ID</u>
DDC	3496, 3497, 122 key	005
DDC	3496, 3497, 102 key	071
DEC	VT510, 520, 525 (PC style)	084
DEC	VT510, 520, 525 (DEC style LK411)	104
Esprit	200, 400	005
Heath Zenith	PC, AT	003 *
Heath Zenith		090
HP	Vectra	003 *
HP	Vectra	023
IBM	XT	001
IBM	PS/2 25, 30, 77DX2	002
IBM	AT, PS/2 30–286, 50, 55SX, 60, 70, 70–061, 70–121, 80	003 *
IBM 102 key	3151, 3161, 3162, 3163, 3191, 3192, 3194, 3196, 3197, 3471, 3472, 3476, 3477	006
IBM 122 key	3191, 3192, 3471, 3472	007
IBM 122 key	3196, 3197, 3476, 3477, 3486, 3482, 3488	008
IBM 122 key	3180	024
IBM 122 key	3180 data entry keyboard	114
IBM DOS/V 106 key	PC & Workstation	102
IBM SurePOS	USB Hand Held Imager	128**
IBM SurePOS	USB Tabletop Imager	129**
IBM Thinkpad	360 CSE, 340, 750	097
IBM Thinkpad		106
IBM Thinkpad	365, 755CV	003 *
I/O 122 key	2676D, 2677C, 2677D	008
ITT	9271	007
Lee Data	IIS	007
NEC	98XX Series	103
Olivetti	M19, M200	001
Olivetti	M240, M250, M290, M380, P500	003
RS-232 TTL		000
Serial Wedge		050
Silicon Graphics	Indy, Indigoll	005

Supported Terminals

<u>Terminal</u>	<u>Model(s)</u>	<u>Terminal ID</u>
Telex 88 key	078, 078A, 79, 80, 191, 196, 1191, 1192, 1471, 1472, 1476, 1477, 1483	025
Telex 88 key	Data Entry Keyboard	112
Telex 102 key	078, 078A, 79, 80, 191, 196, 1191, 1192, 1471, 1472, 1476, 1477, 1483	045
Telex 122 key	078, 078A, 79, 80, 191, 196, 1191, 1192, 1471, 1472, 1476, 1477, 1482, 1483	046
USB COM Port Emulation		130
USB PC Keyboard		124**
USB Mac Keyboard		125**
USB Japanese Keyboard (PC)		134**
USB HID POS		131**
Wand Emulation (Code 39 Format)		061
Wand Emulation (Same Code Format)		064

* Default for 2020-5B and 2020-5BE models

**It is best to use the Plug and Play bar codes, beginning on [page 2-1](#) to program these interfaces, rather than scanning the terminal ID listed in this table.

Keyboard Country

Scan the appropriate country code below to program the keyboard for your country. As a general rule, the following characters are supported, but need special care for countries other than the United States:

@ | \$ # { } [] = / ' \ < > ~



* United States



Belgium



Brazil



Canada (French)



Czech Republic



Denmark



Finland (Sweden)



France



Germany/Austria



Greece



Hungary



Israel (Hebrew)

Keyboard Country (continued)



Italy



Netherlands (Dutch)



Poland



Romania



SCS



Spain



Switzerland (German)



Latin America



Norway



Portugal



Russia



Slovakia



Sweden

Keyboard Country (continued)



Turkey F



Turkey Q



U.K.

Please refer to the Hand Held Products website (www.handheld.com) for complete keyboard country support information and applicable interfaces. If you need to program a keyboard for a country other than one listed above, scan the **Program Keyboard Country** bar code below, then scan the numeric bar code(s) for the appropriate country from the inside back cover, then the **Save** bar code.



Program Keyboard Country

Keyboard Style

This programs keyboard styles, such as Caps Lock and Shift Lock. *Default = Regular.*

Regular is used when you normally have the Caps Lock key off.



* Regular

Caps Lock is used when you normally have the Caps Lock key on.



Caps Lock

Shift Lock is used when you normally have the Shift Lock key on (not common to U.S. keyboards).



Shift Lock

Automatic Caps Lock is used if you change the Caps Lock key on and off. The software tracks and reflects if you have Caps Lock on or off (AT and PS/2 only). This selection can only be used with systems that have an LED which notes the Caps Lock status.



Automatic Caps Lock

Autocaps via NumLock bar code should be scanned in countries (e.g., Germany, France) where the Caps Lock key cannot be used to toggle Caps Lock. The NumLock option works similarly to the regular Autocaps, but uses the NumLock key to retrieve the current state of the Caps Lock.



Autocaps via NumLock

Emulate External Keyboard should be scanned if you do not have an external keyboard (IBM AT or equivalent).



Emulate External Keyboard

Note: After scanning the Emulate External Keyboard bar code, you must power cycle your computer.

Keyboard Modifiers

This modifies special keyboard features, such as CTRL+ ASCII codes and Turbo Mode.

Control + ASCII Mode On: The imager sends key combinations for ASCII control characters for values 00-1F. Refer to [Keyboard Function Relationships](#), page 10-1 for CTRL+ ASCII Values. *Default = Off*



Control + ASCII Mode On



* Control + ASCII Mode Off

Turbo Mode: The imager sends characters to a terminal faster. If the terminal drops characters, do not use Turbo Mode. *Default = Off*



Turbo Mode On



* Turbo Mode Off

Numeric Keypad Mode: Sends numeric characters as if entered from a numeric keypad. *Default = Off*



Numeric Keypad Mode On



* Numeric Keypad Mode Off

Automatic Direct Connect Mode: This selection can be used if you have an IBM AT style terminal and the system is dropping characters. *Default = Off*



Automatic Direct
Connect Mode On



* Automatic Direct Connect
Mode Off

RS-232 Baud Rate

Baud Rate sends the data from the imager to the terminal at the specified rate. The host terminal must be set for the same baud rate as the imager. Default = 115,200.



300



1200



4800



19200



57,600



600



2400



9600



38400



* 115,200

RS-232 Word Length: Data Bits, Stop Bits, and Parity

Data Bits sets the word length at 7 or 8 bits of data per character. If an application requires only ASCII Hex characters 0 through 7F decimal (text, digits, and punctuation), select 7 data bits. For applications which require use of the full ASCII set, select 8 data bits per character. *Default = 8.*

Stop Bits sets the stop bits at 1 or 2. *Default = 1.*

Parity provides a means of checking character bit patterns for validity. *Default = None.*



7 Data, 1 Stop, Parity Even



7 Data, 1 Stop, Parity Odd



7 Data, 2 Stop, Parity None



8 Data, 1 Stop, Parity Even



8 Data, 1 Stop, Parity Odd



7 Data, 1 Stop, Parity None



7 Data, 2 Stop, Parity Even



7 Data, 2 Stop, Parity Odd



* 8 Data, 1 Stop, Parity None

RS-232 Receiver Time-Out

The unit stays awake to receive data until the RS-232 Receiver Time-Out expires. A manual or serial trigger resets the time-out. When an RS-232 receiver is sleeping, a character may be sent to wake up the receiver and reset the time-out. A transaction on the CTS line will also wake up the receiver. The receiver takes 300 milliseconds to completely come up. Change the RS-232 receiver time-out by scanning the bar code below, then scanning **Save**. The range is 0 to 300 seconds. *Default = 0 seconds (no time-out - always on).*



RS-232 Receiver Time-Out

RS-232 Handshaking

RS-232 Handshaking allows control of data transmission from the imager using software commands from the host device. CTS/RTS operates in mode 2. When this feature is turned **Off**, no data flow control is used. When Data Flow Control is turned **On**, the host device suspends transmission by sending the XOFF character (DC3, hex 13) to the imager. To resume transmission, the host sends the XON character (DC1, hex 11). Data transmission continues where it left off when XOFF was sent. *Default = RTS/CTS, XON/XOFF and ACK/NAK Off.*



RTS/CTS On



* RTS/CTS Off



XON/XOFF On



* XON/XOFF Off



ACK/NAK On



* ACK/NAK Off

Host ACK Selection

Some applications require that the host terminal (or server) approve or reject incoming bar code data and notify the operator of these actions. These applications require that the host maintain control over the response indicators emitted from the source imager. Turning the Host ACK selection on, configures the cordless system imagers to respond to commands from the host system.

The following criteria must be met for the Host ACK to work correctly:

- The cordless system must be configured for “Host Port RS-232” (Terminal ID = 000)
- RTS/CTS is defaulted off. You must enable it if the host system requires it.
- Host ACK must be enabled ([page 2-19](#)).
- System performance degrades when using Host ACK at rates lower than 9600.
- The host terminal software must be capable of interpreting the bar code data, make decisions based on the data content, and send out appropriate escape commands to the source imager.

Escape commands are addressed to the source imager via “Application Work Groups.” Once a command is sent, all imagers in a group respond to that command. Because of this situation, **it is recommended that each imager is assigned to its own group in host ACK mode.**

The commands to which the imager responds are listed on [page 2-20](#). The **<ESC>** is a **1B** in hex. A typical command string is **y <ESC> x**, where “y” is the application work group number, “<ESC> x” is the escape command, and the comma is the terminator.

Commands may be strung together to create custom response sequences. An example of a command string is listed below.

0<ESC>4<ESC>5<ESC>6,

The above example will make an imager in application work group zero beep low, medium, high.

Once Host ACK is enabled, the system works as follows:

- The imager reads a code and sends data to the base/host system. No audible or visual indication is emitted until the imager receives an escape command. The imager read illumination goes out upon a successful read.
- Imager operation is suspended until 1) a valid escape string is received from the host system (via the base) or 2) the imager “times out.”
- Once condition 1 or 2 above has been met, the imager is ready to scan again, and the process repeats.

Time out is indicated by three rapid beeps at the same pitch. A time out occurs if the source imager does not receive a valid escape command in 10 seconds. If a time out occurs, the operator should check the host system to understand why a response to the imager was not received.

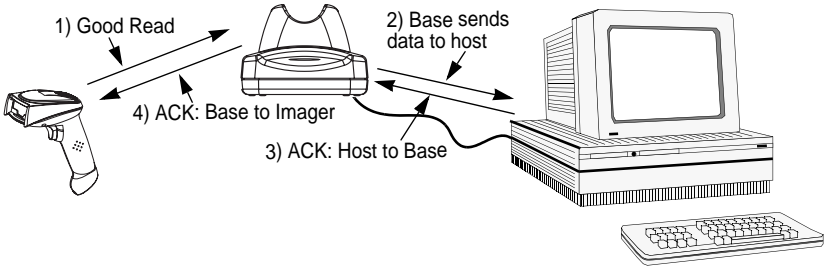

Host ACK Enable



Host ACK On



* Host ACK Off

2020 Host Escape Commands

Command	Action
<ESC> a	Indicate as if successful menu change made
<ESC> b	Indicate as if unsuccessful menu change made
<ESC> 1	Illuminate green LED for 135 milliseconds (followed by at least 70 mSecs. dark time when multiple blinks)
<ESC> 2	Illuminate green LED for two seconds (followed by at least 500 mSecs. dark time when multiple blinks)
<ESC> 3	Illuminate green LED for five seconds (followed by at least 500 mSecs. dark time when multiple blinks)
<ESC> 4	One beep at low volume
<ESC> 5	One beep at medium volume
<ESC> 6	One beep at high volume
<ESC> 7	Indicate as successful decode and communication to host.
<ESC> 8	Indicate as unsuccessful decode and communication to host.

Wand Emulation

Wand Emulation Connection

The Wand Emulation Connection bar codes should be used if you want to change the terminal ID *only*, without changing any other imager settings. We recommend using Wand Emulation Plug & Play bar codes to program your imager to emulate a wand reader. The Wand Emulation Plug & Play bar codes change other parameters, in addition to changing the terminal ID. Please refer to [Wand Emulation Plug & Play](#) on page 2-2 for further information.

In Wand Emulation mode, the imager decodes the bar code then sends data in the same format as a wand scanner. The Code 39 Format converts all symbologies to Code 39.

The Same Code Format transmits UPC, EAN, Code 128 and Interleaved 2 of 5 without any changes, but converts all other symbologies to Code 39. 2D symbologies are converted to Code 128.

The **Code 39 Format** bar code below sets the terminal ID to 61, and the **Same Code Format** bar code sets the terminal ID to 64. *Default = Code 39 Format.*



Code 39 Format



Same Code Format

Wand Emulation Data Block Size

This transmits the data in smaller blocks to prevent buffer overflow. *Default = 40.*



20



* 40



60



80

Wand Emulation Delay Between Blocks

This sets the delay time between data blocks. *Default = 50ms.*



Wand Emulation Overall Checksum

When this option is turned on, a computed check character is added at the end of the entire message. The check character is the character which when Exclusive-OR'd with every preceding character of the message yields a result of 0x00 (00H). *Default = Off.*



Wand Emulation Transmission Rate

The Transmission Rate is limited by the terminal's ability to receive data without dropping characters. *Default = 25 inches/second.*



10



* 25



40



80



120



150



200

Wand Emulation Polarity

The Polarity can be sent as standard with black bars high, or reversed with white spaces high. *Default = Black High.*



* Black High



White High

Wand Emulation Idle

The idle describes the state of the imager when no data is being transmitted. When in Wand Emulation mode, you must set the imager's idle state to match the idle state for the device to which the imager is connected. *Default = Idle High.*



* Idle High



Idle Low

Cordless Base

The cordless base provides the link between the cordless imager and the host system. The base contains an interface assembly and an RF communication module. The RF communication module performs the data exchange between the cordless imager and the interface assembly. The control assembly coordinates the central interface activities including: transmitting/receiving commands and data to/from the host system, performing software activities (parameter menuing, visual indicator support, power-on diagnostics), and data translation required for the host system.

The base also is the imager's battery charger. Refer to "[Base Charge Mode](#)" on page 3-3 for additional information.

RF (Radio Frequency) Module Operation

The cordless system uses a two-way Bluetooth radio to transmit and receive data between the imager and the base. Designed for point-to-point and multipoint-to-single point applications, the radio operates using a license free ISM band, which sends relatively small data packets at a fast data rate over a radio signal with randomly changing frequencies, makes the cordless system highly responsive to a wide variety of data collection applications and resistant to noisy RF environments. Bluetooth Class 2 power level provides a communication range of 33 feet (10m) between the imager and base/Bluetooth adapter, depending on the environment.

Cordless Imager

The cordless imager enables fast and accurate bar code scanning using a non-contact area imager.

The imager is comprised of an area image engine, a decode/control assembly, and an RF communication module. The image engine performs the bar code image illumination and sensing. The decode/control assembly coordinates the central communication activities including: capturing and decoding the bar code image data, performing software activities (parameter menuing, visual indicator support, low battery indication), and data translation required for the host system. The RF communication module performs the data exchange between the imager and the base.

System Conditions

The components of the cordless system interact in specific ways as you associate an imager to a base, as you move an imager out of range, bring an imager back in range, or swap imagers between two cordless systems. The following information explains the cordless system operating conditions.

Linking Process

Once an imager is placed into the base, the imager's battery charge status is checked, and software automatically detects the imager and links it to the base depending on the selected link mode.

Imager Is Out of Range

The cordless imager is in communication with its base, even when it is not transmitting bar code data. Whenever the imager can't communicate with the base for a few seconds, it is out of range. If the imager is out of range and you scan a bar code, the imager issues a triple beep indicating no communication with the base. In addition, your imager and base can sound an alarm if programmed to emit an alarm. Refer to "[Out-of-Range Alarm](#)" on page 3-13.

Imager Is Moved Back Into Range

The imager re-links if the imager or the base have been reset or the imager comes back into range. If the imager re-links, you will hear a single chirp when the re-linking process (uploading of the parameter table) is complete.

Out of Range and Back into Range with Data Accumulation Mode On

The imager may store a number of symbols (approximately 500 UPC symbols, others may vary) when out of range and then send them to the base when back in range. You will not hear a communication error beep in this mode, but you will hear a short buzz when you pull the trigger if the radio communication is not working. Once the radio connection is made, the imager produces a series of beeps while the data is being transferred to the base.

Base Charge Mode

In order for the battery to be charged, there must be enough voltage for the circuitry to work. There are three methods during which power can be supplied to the base:

- 1: 9VDC power supply connected to the barrel connector
- 2: 12VDC host power source only
- 3: 5VDC host power source only

The chart below describes each selection by condition.

	1	2	3
Automatic	Fast Charge	Slow Charge	No Charge
Full Charge Rate	Fast Charge	Fast Charge	No Charge
Low Charge Rate	Slow Charge	Slow Charge	No Charge
Battery Charge Off	No Charge	No Charge	No Charge

Using a slow charge rate draws less current (power) from the input power source when the battery is mostly discharged.

Note: If you attach the 4820/4820i system to a host with a 12V power source, the 12V host is dominant; the system pulls power from the host and not the 9V power supply. For example, if you have a host system with a 12 volt available to the base, it will supersede the 9V power supply. The 9V supply is not needed for 12V host applications and only serves as a backup if the system goes down.

Scan the appropriate bar code for your application. *Default = Automatic.*



* Automatic



Full Charge Rate



Low Charge Rate



Battery Charge Off

Beeper and LED Sequences and Meaning

The imager contains LEDs on the top of the unit to indicate its power up, communication, and battery status. Simply stated, red LED = error; green LED = success of any type. The unit's audible indicators have meaning as well: 3 beeps = error; 2 beeps = menu change; 1 beep = all other successes.

The table below lists the indication and cause of the LED illumination and beeps for the imager.

Imager LED Sequences and Meaning

LED Indication	Beeper Indication	Cause
Normal Operation		
Red Flash	None	Battery low
Green Flash	1 beep	Successful communication or linking
Red, blinking	3 beeps	Failed communication
Menu Operation		
Green Flash	2 beeps	Successful menu change
Red, blinking	3 beeps	Unsuccessful menu change

2020 LED Sequences and Meaning

The base contains a red LED that indicates the status of the unit and verifies its communication with the host system and a green LED that indicates imager battery charge condition.

Charge Condition	Charge Status Indicator (Green LED)
Imager inserted into base	Three flashes
>80% charged	On continuously
30% to 80% charged	Slow flash, 1 second on, 1 second off
<30% charged	Fast flash, 300 mSec on, 300 mSec off

Note: Charging only occurs with external power applied to the 2020 or 12 volt host power.

The table below list the indication and cause of the LED illumination and beeps for the 2020.

System Condition	System Status Indicator (Red LED)
Power On/System Idle	LED is on
Power On/Diagnostic Error	Blink LED for long duration, pulsing indefinitely
Receiving Data (2020 only)	Blink LED for short duration in multiple pulses. Occurs while transferring data to/from the RF module or the Host port.
Base requests status from its own Bluetooth radio	Blink LED once (occurs approx. every 30 seconds)

Imager Modes

The 4820/4820i is capable of working in single imager mode, multiple imager mode, or with Bluetooth devices, other than the 2020 base.

Unlinking the Imager

If the base has an imager linked to it, that imager must be unlinked before a new imager can be linked. Once the previous imager is unlinked, it will no longer communicate with the base. To unlink an imager from the base, scan the Unlink Imager bar code below.



Unlink Imager

Single Imager Operation

There are two link modes to accommodate different applications: Locked Link Mode and Open Link Mode. Scan the appropriate bar codes included in the Open Link and Locked Link Mode explanations that follow to switch from one mode to another. *Default = Locked Link Mode.*

Locked Link Mode - Single Imager

If you link an imager to a base using the Locked Link Mode, other imagers are blocked from being linked if they are inadvertently placed into the base. If you do place a different imager into the base, it will charge the imager, but the imager will not be linked.



* Locked Link Mode
(Single Imager)

To use a different imager, you need to unlink the original imager by scanning the Unlink Imager bar code. (See "Imager Modes" on page 3-5.)

Open Link Mode - Single Imager

When newly shipped or defaulted to factory settings, the base and imager are not linked. By placing an imager into the base, they establish a link. Placing a different imager into the base establishes a new link and the old imager is unlinked. Each time an imager is placed into the base, it becomes the linked imager; the old imager is unlinked.



Open Link Mode
(Single Imager)

Override Locked Imager

If you need to replace a broken or lost imager that is linked to a base, scan the Override Locked Imager bar code below with a new imager and place that imager in the base. The locked link will be overridden; the broken or lost imager's link with the base will be removed, and the new imager will be linked.



Override Locked Imager
(Single Imager)

Multiple Imager Operation

Note: Multiple Imager Operation Mode allows you to link up to 7 imagers to one base. You cannot join an eighth imager until you unlink one of the 7 imagers or take an imager out of range.

To put the imager in multiple imager mode, scan the bar code below. Once you scan this bar code, the imager is unlinked from the base and must be placed into the base to re-link.



Multiple Imager Operation

Imager Name

You may assign a name to each imager you are using. When you have multiple imagers linked to one base, you may want to name each imager so you will be able to control the imager receiving imaging commands sent from the base.

The default name for a 4820 is "4820," and "4820i" for a 4820i. If you have more than one imager linked to a base, and they all have the default names, the first imager linked to the base receives commands. You can change the name of an imager using a serial command (refer to "Imager Name" on page 12-8) or using a bar code command. To change the name serially, unlink all except one of the imagers from the base. Send ":4820:BT_NAMname." or ":4820i:BT_NAMname.", where *name* is the new imager name. If you wish to change the names of additional imagers, re-link them one at a time and repeat the ":4820:BT_NAMname." or ":4820i:BT_NAMname." command for each imager.

To rename imagers with sequential, numeric names, scan the bar codes below. Scan the **Reset** code after each name change and wait for the scanner to re-link to the base before scanning another bar code to rename the next imager.



0001



0002



0003



0004



0005



0006



0007



Reset

Alternatively, you may change the name with a bar code command if you cannot send serial commands to the base. One way to do this is to scan the bar code below and scan a number for the imager name. For example, if you had 7 imagers to one base, scan the bar code below with the first imager, scan the **1** bar code on the [Programming Chart](#) inside the back cover of this manual and scan **Save**. Then scan the **Reset** bar code and wait for the scanner to re-link to the base before scanning the next bar code. Repeat that process for imager number 2, 3, 4 etc.



Imager Name

If you want to assign an alphabetic name to the imager, create a Code 128 bar code containing “~BT_NAMname.” followed by a FNC3 character (hexidecimal 83), where *name* is the new imager name. Scan the **Reset** bar code ([page 3-8](#) or on the [Programming Chart](#) inside the back cover of this manual). You may use Barcode Builder, which is included with Quick*View. Refer to [Quick*View](#) on page 11-5 for instructions about downloading Quick*View from the Hand Held Products website: www.handheld.com.

Imager Report

Scan the bar code below to generate a report for the connected imagers. The report indicates the port, work group, imager name, and address.



Imager Report

Application Work Groups

Your cordless system can have up to seven imagers linked to one base. You can also have up to seven work groups. If you want to have all of the imagers' settings programmed alike, you don't need to use more than one work group. If you want each imager to have unique settings (e.g., beeper volume, prefix/suffix, data formatter), then you may program each imager to its own unique work group and may program each imager independently. For example, you might want to have multiple work groups in a retail/warehouse application where you need to have different data appended to bar codes used in the warehouse area versus the retail area. You could assign all of the imagers in the retail area to one work group and those in the warehouse to another. Consequently, any desired changes to either the retail or warehouse area would apply to all imagers in that particular work group. Visual Xpress ([page 11-4](#)) makes it easy for you to program your system for use with multiple imagers and multiple work groups.

The imager keeps a copy of the menu settings it is using. Whenever the imager is connected or reconnected to a base, the imager is updated with the latest settings from the base for its work group. The imager also receives menu setting changes processed by the base. If an imager is removed from one base and placed into another base, it will be updated with the new base settings for whatever work group that the imager was previously assigned. For example, if the imager was in work group 1 linked to the first base, it will be placed in work group 1 in the second base with the associated settings.

Application Work Group Selection

This programming selection allows you to assign an imager to a work group by scanning the bar code below. You may then program the settings (e.g., beeper volume, prefix/suffix, data formatter) that your application requires.



* Group 0



Group 1



Group 2



Group 3



Group 4



Group 5



Group 6

Resetting the Standard Product Default Settings: All Application Work Groups

The following bar code defaults all of the work groups to the factory settings.



Standard Product Default Settings:
All Application Groups

The [Menu Commands](#), beginning on page 12-5 list the standard product default settings for each of the commands (indicated by an asterisk (*) on the programming pages).

Resetting the Standard Product Default Settings: Current Application Work Group

If you aren't sure what programming options are in your imager, or you've changed some options and want the standard product default settings restored, scan the **Standard Product Default Settings: Current Application Group** bar code below.

The [Menu Commands](#), beginning on page 12-5 list the factory default settings for each of the commands (indicated by an asterisk (*) on the programming pages).

Note: Scanning this bar code also causes both the imager and the base to perform a reset and become unlinked. The imager must be placed in its base to re-establish the link before any setup codes are entered. Refer to "Imager Modes" on page 3-5 for additional information.



Standard Product Default Settings:
Current Application Group

*Note: If your imager is in multiple imager mode and you scan either the current or all application group default bar code, you will hear up to 30 seconds of beeping while all imagers are re-linked from the base and the settings are defaulted to * settings. The default interface is keyboard wedge and the default imager mode is single imager locked link mode.*

Using the Imager with Bluetooth Devices

The imager can be used either with the 2020 base or with other Bluetooth devices. Scanning the Non-Base Bluetooth Connection bar code below allows the imager to be used with other Bluetooth devices (e.g., PDA, PC - Bluetooth USB Adapter). After you scan the bar code below, follow the instructions supplied with your Bluetooth device to locate the imager and connect to it. If you go out of range with your imager, the imager automatically reconnects to the Bluetooth device when it is back in range. If you want to re-link to the 2020 base, refer to "[Single Imager Operation](#)" on page 3-5 or "[Multiple Imager Operation](#)" on page 3-7.

Note: The multiple work groups option is not available when you are using the imager with Bluetooth devices other than the 2020 base.



Non-Base BT Connection

Changing Bluetooth PIN Code

Some devices require a PIN code as part of the Bluetooth security features. Your imager's default PIN is 1234, which you may need to enter the first time you connect to your PDA or PC. The PIN code must be between 1 and 16 characters. To change the PIN, scan the bar code below and then scan the appropriate numeric bar codes from the [Programming Chart](#) inside the back cover of this manual. Scan **Save** to save your selection.



Bluetooth PIN

Out-of-Range Alarm

Duration

If your imager is out range of the base, an alarm sounds from both your base and imager. To activate the alarm options for the imager or the base and to set the alarm duration, scan the appropriate bar code below and then set the time-out duration (from 0-3000 seconds) by scanning digits on the [Programming Chart](#) inside the back cover, then scanning **Save**. *Default = 0 sec (no alarm).*



Base Alarm Duration



Imager Alarm Duration

Note: If you are out of range when you scan a bar code, you will receive an error beep even if you do not have the alarm set. You receive the error beep since the data could not be communicated to the base or the host.

Alarm Sound Type

If you have set the out-of-range alarm enabled, you may change the alarm type for the imager or base by scanning the appropriate bar code below and then scanning a digit (0-7) bar code and the **Save** bar code on the [Programming Chart](#) inside the back cover of this manual. *Default = 0.* Set the sound type to fit your application.



Base Alarm Type



Imager Alarm Type

Data Accumulation Mode

Scan the bar codes below to turn data accumulation (batch) mode on and off. If data accumulation mode is on, bar code data is stored when the imager is out of range of the base and transmitted once the imager is back in range.



Data Accumulation Mode On



* Data Accumulation Mode Off

Good Read Indicators

Beeper – Good Read

The beeper may be programmed **On** or **Off** in response to a good read. Turning this option off, only turns off the beeper response to a good read indication. All error and menu beeps are still audible. *Default = On.*



* Beeper - Good Read On



Beeper - Good Read Off

Beeper Volume – Good Read

The beeper volume codes modify the volume of the beep the imager emits on a good read. *Default = Medium.*



Low



* Medium



High



Off

Beeper Pitch – Good Read

The beeper pitch codes modify the pitch (frequency) of the beep the imager emits on a good read. *Default = Medium.*



Low (1600 Hz)



* Medium (3250 Hz)



High (4200 Hz)

Beeper Duration – Good Read

The beeper duration codes modify the length of the beep the imager emits on a good read. *Default = Normal.*



* Normal Beep



Short Beep

LED – Good Read

The LED indicator can be programmed **On** or **Off** in response to a good read. *Default = On.*



* LED - Good Read On



LED - Good Read Off

Number of Beeps – Good Read

The number of beeps of a good read can be programmed from 1 - 9. The same number of beeps will be applied to the beeper and LED in response to a good read. For example, if you program this option to have five beeps, there will be five beeps and five LED flashes in response to a good read. The beeps and LED flashes are in sync with one another. To change the number of beeps, scan the bar code below and then scan a digit (1-9) bar code and the **Save** bar code on the [Programming Chart](#) inside the back cover of this manual. *Default = One.*



Number of Beeps/LED Flashes

Good Read Delay

This sets the minimum amount of time before the imager can read another bar code. *Default = 0 ms (No Delay).*



* No Delay



Short Delay (500 ms)



Medium Delay (1,000 ms)



Long Delay (1,500 ms)

User-Specified Good Read Delay

If you want to set your own length for the good read delay, scan the bar code below, then set the delay (from 0-30,000 milliseconds) by scanning digits from the inside back cover, then scanning **Save**.



User-Specified Good Read Delay

Serial Trigger Modes

Manual/Serial Trigger, Low Power

You can activate the imager either by pressing the trigger, or using a serial trigger command (see [Trigger Commands](#) on page 12-4). When in manual trigger mode, the imager scans until a bar code is read, or until the trigger is released.

When in serial mode, the imager scans until a bar code has been read or until the deactivate command is sent. In serial mode, the imager can also be set to turn itself off after a specified time has elapsed (see [Read Time-Out \(Serial Trigger Mode\)](#), which follows).



* Manual/Serial Trigger

Read Time-Out (Serial Trigger Mode)

Use this selection to set a time-out (in milliseconds) of the imager's trigger when using serial commands to trigger the imager. Once the imager has timed out, you can activate the imager either by pressing the trigger or using a serial trigger command. After scanning the **Read Time-Out** bar code, set the time-out duration (from 0-300,000 milliseconds) by scanning digits on the [Programming Chart](#) inside the back cover, then scanning **Save**. *Default = 300,000 ms.*



Read Time-Out

Imager Power Time-Out Timer

Note: The Imager Power Time-out Timer option only applies to Manual/Serial Trigger.

When there is no activity within a specified time period, the imager enters low power mode. Scan the appropriate Imager Power Time-Out bar code to change the time-out duration (in seconds).

Note: Scanning zero (0) is the equivalent of setting no time-out.

If there are no trigger pulls during the “imager power time-out timer” interval, the imager goes into power down mode. Whenever the trigger is enabled, the “imager power time-out timer” is reset. If the imager is placed in the 2020 cradle and the battery is in the process of being charged, the imager will not go into power down mode.



0 seconds



200 seconds



400 seconds



900 seconds



* 3600 seconds



7200 seconds

Note: When the imager is in power down mode, pull the trigger to power the unit back up. There will be a set of power up beeps and a delay of up to a few seconds for the radio to join. The imager will then be ready to use.

Scan Stand Mode

When a unit is in Scan Stand mode, it remains idle as long as it sees the Scan Stand symbol. (See **Scan Stand Symbol** that follows.) When a different code is presented, the imager is triggered to read the new code.

Note: The imager automatically adjusts the illumination LEDs to the lowest light level possible to maintain a good lock on the Scan Stand symbol. When a symbol is presented, the imager's light levels adjust to the saved setting (see [LED Power Level](#) on page 4-9). This mode requires at least 50 lux of ambient light to operate correctly.



Scan Stand Mode

Scan Stand Symbol

When a unit is in Scan Stand mode, the LEDs shine at the Scan Stand symbol on the base of the stand which tells it to remain idle. When the Scan Stand symbol is covered, the imager turns the LEDs on at the configured power level (Default High) and attempts to find and decode bar codes in its field of view.



Scan Stand Symbol

Presentation Mode

Note: This mode requires at least 50 lux of ambient light to operate correctly.

Scanning the bar code below programs the imager to work in Presentation Mode. Presentation Mode uses ambient light to detect bar codes. The LEDs are off until a bar code is presented to the imager, then the LEDs turn on automatically to read the code. If the light level in the room is not high enough, Presentation Mode may not work properly.



Presentation Mode

Presentation LED Behavior after Decode

When an imager is in presentation mode, the LEDs remain on and continue scanning for a short time after a bar code is decoded. If you wish to turn the LEDs off immediately after a bar code is decoded, scan the **LEDs Off** bar code, below. *Default = LEDs On.*



* LEDs On



LEDs Off

Presentation Sensitivity

Presentation Sensitivity is a numeric range that increases or decreases the imager's reaction time to bar code presentation. To set the sensitivity, scan the **Sensitivity** bar code, then scan the degree of sensitivity (from 0-20) from the inside back cover, and **Save**. 0 is the most sensitive setting, and 20 is the least sensitive. *Default = 1.*



Sensitivity

Hands Free Time-Out

The Scan Stand and Presentation Modes are referred to as “hands free” modes. If the imager's trigger is pulled when using a hands free mode, the imager changes to manual trigger mode. You can set the time the imager should remain in manual trigger mode by setting the Hands Free Time-Out. Once the time-out value is reached, (if there have been no further trigger pulls) the imager reverts to the original hands free mode.

Scan the **Hands Free Time-Out** bar code, then scan the time-out duration (from 0-300,000 milliseconds) from the inside back cover, and **Save**. *Default = 5,000 ms.*



Hands Free Time-Out

Reread Delay

This sets the time period before the imager can read the *same* bar code a second time. Setting a reread delay protects against accidental rereads of the same bar code. Longer delays are effective in minimizing accidental rereads. Use shorter delays in applications where repetitive bar code scanning is required. *Default = Medium.*

Reread Delay only works when in [Presentation Mode](#) (see page 4-6).



Short (500 ms)



* Medium (750 ms)



Long (1000 ms)



Extra Long (2000 ms)

User-Specified Reread Delay

If you want to set your own length for the reread delay, scan the bar code below, then set the delay (from 0-30,000 milliseconds) by scanning digits from the inside back cover, then scanning **Save**.



User-Specified Reread Delay

LED Power Level

This selection allows you to adjust LED and aimer brightness. **Off** is used when no illumination is needed. **Low** is used if low illumination is sufficient. **High** (the default) is the brightest setting.

If you have an aimer delay programmed (see [Aimer Delay](#) on page 4-10), the aimer will be at 100% power during the delay, regardless of the LED Power Level.

*Note: If you scan the **Off** bar code, both the aimer and illumination lights turn off, making it impossible to scan bar codes in low light. To turn the LED Power Level back on, move to a brightly lit area and scan either the **Low** or the **High** bar code below.*



Off



Low (50%)



* High (100%)

Illumination Lights

If you want the illumination lights on while reading a bar code, scan the **Lights On** bar code, below. However, if you want to turn just the lights off, scan the **Lights Off** bar code.

Note: This setting does not affect the aimer light. The aiming light can be set using [Aimer Mode](#) (page 4-10).



* Lights On



Lights Off

Aimer Delay

The aimer delay allows a delay time for the operator to aim the imager before the picture is taken. Use these codes to set the time between when the trigger is pulled and when the picture is taken. During the delay time, the aiming light will appear, but the LEDs won't turn on until the delay time is over.



200 milliseconds



400 milliseconds



* Off (no delay)

User-Specified Aimer Delay

If you want to set your own length for the duration of the delay, scan the bar code below, then set the time-out by scanning digits (0 - 4,000 ms) from the [Programming Chart](#) inside the back cover of this manual, then scan **Save**.



Delay Duration

Aimer Mode

This feature allows you to turn the aimer on and off. When the Interlaced bar code is scanned, the aimer is interlaced with the illumination LEDs.



Off



* Interlaced

Centering

Use Centering to narrow the imager's field of view to make sure the imager reads only those bar codes intended by the user. For instance, if multiple codes are placed closely together, centering will insure that only the desired codes are read. (Centering can be used in conjunction with [Aimer Delay](#), page 4-10, for the most error-free operation in applications where multiple codes are spaced closely together. Using the Aimer Delay and Centering features, the imager can emulate the operation of older systems, such as linear laser bar code imagers.)

In the example below, the gray area is the full imager field of view and the white area is the centering window. Bar Code 1 will not be read, while Bar Code 2 will be.

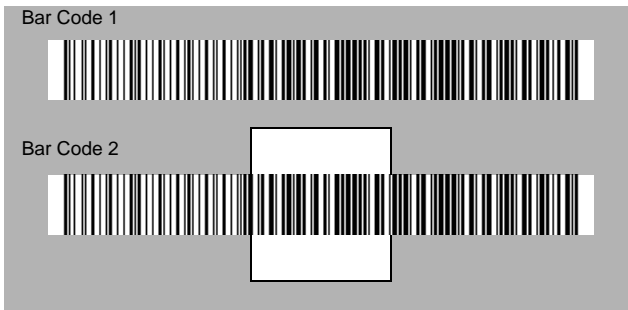

The default centering window is a 128x96 pixel area in the center of the imager's field of view. The following diagram illustrates the default top, bottom, left, and right pixel positions, measured from the top and the left side of the imager's field of view, which is 640 by 480 pixels.

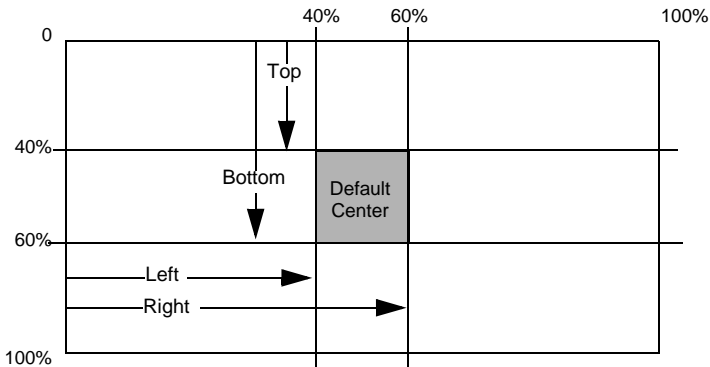

If a bar code is not within the predefined window, it will not be decoded or output by the imager. If centering is turned on by scanning **Centering On**, the imager only reads codes that intersect the centering window you specify using the **Top**, **Bottom**, **Left**, or **Right** bar codes.

Scan **Centering On**, then scan one of the following bar codes to change the top, bottom, left, or right of the centering window. Then scan the percent you want to shift the centering window using digits on the inside back cover of this manual. Scan **Save**. *Default Centering = 40% for Top and Left, 60% for Bottom and Right.*



Centering On



Top of Centering Window



Left of Centering Window



* Centering Off



Bottom of Centering Window



Right of Centering Window

Decode Search Mode

There are two selectable decode (scanning) modes:

Full Omnidirectional - Searches for bar code features beginning at the center of an image, and searches to the image's limits. This mode reads all symbologies (including OCR), in any orientation. The Full Omnidirectional search is very thorough which may slow performance time.

Note: This search mode is the default setting for the imager.



Full Omnidirectional

Quick Omnidirectional - This is an abbreviated search for bar code features around the center region of an image. This mode quickly reads all symbologies in any orientation. The Quick Omnidirectional mode may miss some off-center symbols, as well as larger Data Matrix and QR Code symbols.



Quick Omnidirectional

Output Sequence Overview

Require Output Sequence

When turned off, the bar code data will be output to the host as the imager decodes it. When turned on, all output data must conform to an edited sequence or the imager will not transmit the output data to the host device.

Note: This selection is unavailable when the Multiple Symbols Selection is turned on.

Output Sequence Editor

This programming selection allows you to program the imager to output data (when scanning more than one symbol) in whatever order your application requires, regardless of the order in which the bar codes are scanned. Reading the **Default Sequence** symbol programs the imager to the Universal values, shown below. These are the defaults. Be **certain** you want to delete or clear all formats before you read the **Default Sequence** symbol.

Note: You must hold the trigger while reading each bar code in a sequence.

Note: To make Output Sequence Editor selections, you'll need to know the code I.D., code length, and character match(es) your application requires. Use the Alphanumeric symbols (inside back cover) to read these options.

To Add an Output Sequence

1. Scan the **Enter Sequence** symbol (see [Require Output Sequence](#), page 4-16).
2. **Code I.D.**
On the [Symbology Chart](#) on page A-1, find the symbology to which you want to apply the output sequence format. Locate the Hex value for that symbology and scan the 2 digit hex value from the Programming Chart (inside back cover).
3. **Length**
Specify what length (up to 9999 characters) of data output will be acceptable for this symbology. Scan the four digit data length from the Programming Chart. (Note: 50 characters is entered as 0050. 9999 is a universal number, indicating all lengths.) When calculating the length, you must count any programmed prefixes, suffixes, or formatted characters as part of the length (unless using 9999).
4. **Character Match Sequences**
On the [Code Page Mapping of Printed Bar Codes](#), page A-6, find the Hex value that represents the character(s) you want to match. Use the Programming Chart to read the alphanumeric combination that represents the ASCII characters. (99 is the Universal number, indicating all characters.)
5. **End Output Sequence Editor**
Scan **FF** to enter an Output Sequence for an additional symbology, or **Save** to save your entries.

Other Programming Selections

•**Discard**

This exits without saving any Output Sequence changes.

Output Sequence Example

In this example, you are scanning Code 93, Code 128, and Code 39 bar codes, but you want the imager to output Code 39 1st, Code 128 2nd, and Code 93 3rd, as shown below.

Note: Code 93 must be enabled to use this example.



A - Code 39



B - Code 128



C - Code 93

You would set up the sequence editor with the following command line:

SEQBLK62999941FF6A999942FF69999943FF

The breakdown of the command line is shown below:

SEQBLKsequence editor start command

62 code identifier for **Code 39**

9999 code length that must match for Code 39, 9999 = all lengths

41 start character match for Code 39, 41h = "A"

FF termination string for first code

6A code identifier for **Code 128**

9999 code length that must match for Code 128, 9999 = all lengths

42 start character match for Code 128, 42h = "B"

FF termination string for second code

- 69 code identifier for **Code 93**
- 9999 code length that must match for Code 93, 9999 = all lengths
- 43 start character match for Code 93, 43h = "C"
- FF termination string for third code

To program the previous example using specific lengths, you would have to count any programmed prefixes, suffixes, or formatted characters as part of the length. If you use the example on [page 4-15](#), but assume a <CR> suffix and specific code lengths, you would use the following command line:

SEQBLK62001241FF6A001342FF69001243FF

The breakdown of the command line is shown below:

- SEQBLK sequence editor start command
- 62 code identifier for **Code 39**
- 0012 A - Code 39 sample length (11) plus CR suffix (1) = 12
- 41 start character match for Code 39, 41h = "A"
- FF termination string for first code
- 6A code identifier for **Code 128**
- 0013 B - Code 128 sample length (12) plus CR suffix (1) = 13
- 42 start character match for Code 128, 42h = "B"
- FF termination string for second code
- 69 code identifier for **Code 93**
- 0012 C - Code 93 sample length (11) plus CR suffix (1) = 12
- 43 start character match for Code 93, 43h = "C"
- FF termination string for third code

Output Sequence Editor



Enter Sequence



Default Sequence

Require Output Sequence

When an output sequence is **Required**, all output data must conform to an edited sequence or the imager will not transmit the output data to the host device. When it's **On/Not Required**, the imager will attempt to get the output data to conform to an edited sequence, but if it cannot, the imager transmits all output data to the host device as is.

When the output sequence is **Off**, the bar code data is output to the host as the imager decodes it.

Note: This selection is unavailable when the Multiple Symbols Selection is turned on.



Required



On/Not Required



*Off

Multiple Symbols

When this programming selection is turned **On**, it allows you to read multiple symbols with a single pull of the imager's trigger. If you press and hold the trigger, aiming the imager at a series of symbols, it reads unique symbols once, beeping (if turned on) for each read. The imager attempts to find and decode new symbols as long as the trigger is pulled. When this programming selection is turned **Off**, the imager will only read the symbol closest to the aiming beam.



On



* Off

No Read

With No Read turned **On**, the imager notifies you if a code cannot be read. If using a Quick*View Scan Data Window, an "NR" appears when a code cannot be read. If No Read is turned **Off**, the "NR" will not appear.



On



* Off

If you want a different notation than “NR,” for example, “Error,” or “Bad Code,” you can edit the output message using the [Data Formatter](#) (page 6-5). The hex code for the No Read symbol is 9C.

Print Weight

Print Weight is used to adjust the way the imager reads Matrix symbols. If an imager will be seeing consistently heavily printed matrix symbols, then a print weight of 6 may improve the reading performance. For consistently light printing, a print weight of 2 may help. After scanning the **Set Print Weight** bar code, set the print weight (from 1-7) by scanning digits from the inside back cover, then scanning **Save**. *Default = 4.*



Set Print Weight



* Default

Video Reverse

Video Reverse is used to allow the imager to read bar codes that are inverted. The “Off” bar code below is an example of this type of bar code. If additional menuing is required, Video Reverse must be disabled to read the menu bar codes and then re-enabled after menuing is completed.

Note: Images downloaded from the unit will not be reversed. This is a setting for decoding only.



On



* Off

Working Orientation

Some bar codes are direction-sensitive. For example, KIX codes and OCR can misread when scanned sideways or upside down. Use the working orientation settings if your direction-sensitive codes will not usually be presented upright to the imager. *Default = Upright.*

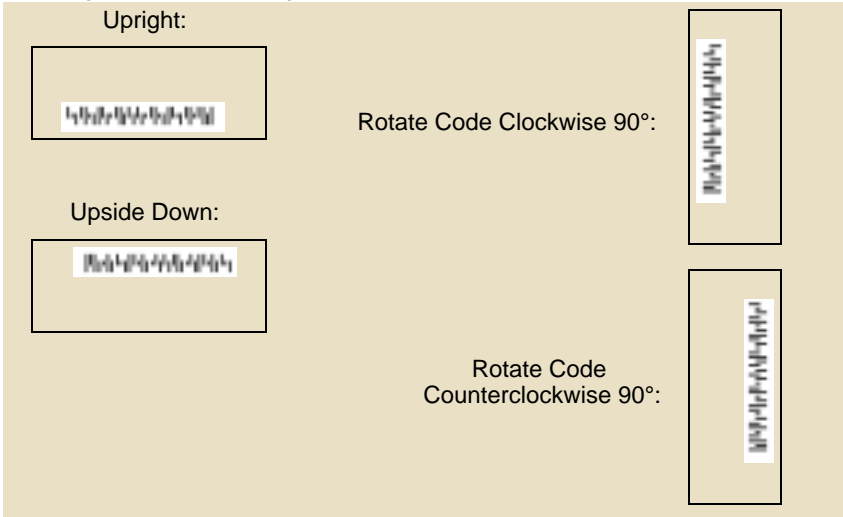



Prefix/Suffix Overview

When a bar code is scanned, additional information is sent to the host computer along with the bar code data. This group of bar code data and additional, user-defined data is called a “message string.” The selections in this section are used to build the user-defined data into the message string.

Prefix and Suffix characters are data characters that can be sent before and after scanned data. You can specify if they should be sent with all symbologies, or only with specific symbologies. The following illustration shows the breakdown of a message string:

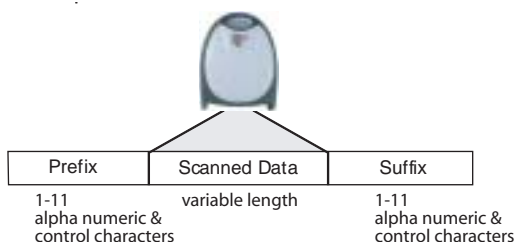

Points to Keep In Mind

- It is not necessary to build a message string. The selections in this chapter are only used if you wish to alter the default settings. *Default prefix = None. Default suffix = None.*
- A prefix or suffix may be added or cleared from one symbology or all symbologies.
- You can add any prefix or suffix from the [Code Page Mapping of Printed Bar Codes](#) on page A-6, plus Code I.D. and AIM I.D.
- You can string together several entries for several symbologies at one time.
- Enter prefixes and suffixes in the order in which you want them to appear on the output.
- When setting up for specific symbologies (as opposed to all symbologies), the specific symbology ID value counts as an added prefix or suffix character.

To Add a Prefix or Suffix:

- Step 1.** Scan the **Add Prefix** or **Add Suffix** symbol (page 5-4).
- Step 2.** Determine the 2 digit Hex value from the Symbology Chart (included in [Appendix A](#)) for the symbology to which you want to apply the prefix or suffix. For example, for Code 128, Code ID is “j” and Hex ID is “6A”.
- Step 3.** Scan the 2 hex digits from the [Programming Chart](#) inside the back cover of this manual or scan **9, 9** for all symbologies.
- Step 4.** Determine the hex value from the [Code Page Mapping of Printed Bar Codes](#) on page A-6, for the prefix or suffix you wish to enter.
- Step 5.** Scan the 2 digit hex value from the [Programming Chart](#) inside the back cover of this manual.
- Step 6.** Repeat Steps 4 and 5 for every prefix or suffix character.
- Step 7.** To add the Code I.D., scan **5, C, 8, 0**.
To add AIM I.D., scan **5, C, 8, 1**.
To add a backslash (\), scan **5, C, 5, C**.

Note: To add a backslash (\) as in Step 7, you must scan 5C twice – once to create the leading backslash and then to create the backslash itself.

- Step 8.** Scan **Save** to exit and save, or scan **Discard** to exit without saving.
- Repeat Steps 1-6 to add a prefix or suffix for another symbology.

Example: Add a Suffix to a specific symbology

To send a CR (carriage return) Suffix for UPC only:

- Step 1.** Scan **Add Suffix**.
- Step 2.** Determine the 2 digit hex value from the Symbology Chart (included in [Appendix A](#)) for UPC.
- Step 3.** Scan **6, 3** from the [Programming Chart](#) inside the back cover of this manual.
- Step 4.** Determine the hex value from the [Code Page Mapping of Printed Bar Codes](#) on page A-6, for the CR (carriage return).
- Step 5.** Scan **0, D** from the [Programming Chart](#) inside the back cover of this manual.
- Step 6.** Scan **Save**, or scan **Discard** to exit without saving.

To Clear One or All Prefixes or Suffixes:

You can clear a single prefix or suffix, or clear all prefixes/suffixes for a symbology. When you Clear One Prefix (Suffix), the specific character you select is deleted from the symbology you want. When you Clear All Prefixes (Suffixes), all the prefixes or suffixes for a symbology are deleted.

Step 1. Scan the **Clear One Prefix** or **Clear One Suffix** symbol.

Step 2. Determine the 2 digit Hex value from the Symbology Chart (included in [Appendix A](#)) for the symbology from which you want to clear the prefix or suffix.

Step 3. Scan the 2 digit hex value from the [Programming Chart](#) inside the back cover of this manual or scan **9, 9** for all symbologies.

Your change is automatically saved.

To Add a Carriage Return Suffix to all Symbologies

Scan the following bar code if you wish to add a carriage return suffix to all symbologies at once. This action first clears all current suffixes, then programs a carriage return suffix for all symbologies.



Add CR Suffix
All Symbologies

Prefix Selections



Add Prefix



Clear All Prefixes



Clear One Prefix

Suffix Selections



Add Suffix



Clear All Suffixes



Clear One Suffix

Function Code Transmit

When this selection is enabled and function codes are contained within the scanned data, the imager transmits the function code to the terminal. Charts of these function codes are provided in [Supported Interface Keys](#) starting on [page 10-3](#). When the imager is in keyboard wedge mode, the scan code is converted to a key code before it is transmitted. *Default = Enable.*



* Enable



Disable

Intercharacter, Interfunction, and Intermessage Delays

Some terminals drop information (characters) if data comes through too quickly. Intercharacter, interfunction, and intermessage delays slow the transmission of data, increasing data integrity.

Each delay is composed of a 5 millisecond step. You can program up to 99 steps (of 5 ms each) for a range of 0-495 ms.

Intercharacter Delay

An intercharacter delay of up to 495 milliseconds may be placed between the transmission of each character of scanned data. Scan the **Intercharacter Delay** bar code below, then scan the number of milliseconds and the **SAVE** bar code using the [Programming Chart](#) inside the back cover of this manual.

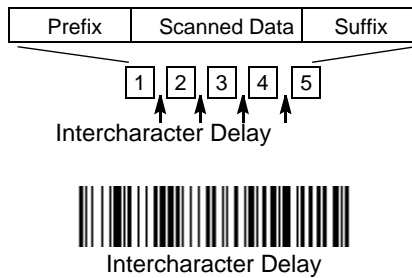

To remove this delay, scan the **Intercharacter Delay** bar code, then set the number of steps to 0. Scan the **SAVE** bar code using the [Programming Chart](#) inside the back cover of this manual.

Note: Intercharacter delays are not supported in USB serial emulation.

User Specified Intercharacter Delay

An intercharacter delay of up to 495 milliseconds may be placed after the transmission of a particular character of scanned data. Scan the **Delay Length** bar code below, then scan the number of milliseconds and the **SAVE** bar code using the [Programming Chart](#) inside the back cover of this manual.

Next, scan the **Character to Trigger Delay** bar code, then the 2-digit hex value for the ASCII character that will trigger the delay [Code Page Mapping of Printed Bar Codes](#) on page A-6.



Delay Length



Character to Trigger Delay

To remove this delay, scan the **Delay Length** bar code, and set the number of steps to 0. Scan the **SAVE** bar code using the [Programming Chart](#) inside the back cover of this manual.

Interfunction Delay

An interfunction delay of up to 495 milliseconds may be placed between the transmission of each segment of the message string. Scan the **Interfunction Delay** bar code below, then scan the number of milliseconds and the **SAVE** bar code using the [Programming Chart](#) inside the back cover of this manual.

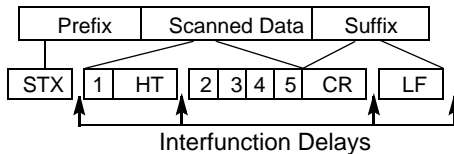

Interfunction Delay

To remove this delay, scan the **Interfunction Delay** bar code, then set the number of steps to 0. Scan the **SAVE** bar code using the [Programming Chart](#) inside the back cover of this manual.

Intermessage Delay

An intermessage delay of up to 495 milliseconds may be placed between each scan transmission. Scan the **Intermessage Delay** bar code below, then scan the number of milliseconds and the **SAVE** bar code using the [Programming Chart](#) inside the back cover of this manual.

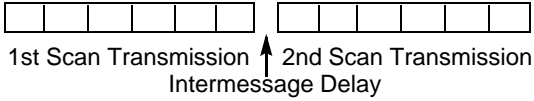

To remove this delay, scan the **Intermessage Delay** bar code, then set the number of steps to 0. Scan the **SAVE** bar code using the [Programming Chart](#) inside the back cover of this manual.



Data Format Editor Introduction

You may use the Data Format Editor to change the imager's output. For example, you can use the Data Format Editor to insert characters at certain points in bar code data as it is scanned. The selections in the following pages are used only if you wish to alter the output. *Default Data Format setting = None.*

Normally, when you scan a bar code, it gets outputted automatically; however when you do a format, you must use a "send" command (see [Send Commands](#) on page 6-2) within the format program to output data.

Multiple formats may be programmed into the imager. They are stacked in the order in which they are entered. However, the following list presents the order in which formats are applied:

1. Specific Term ID, Actual Code ID, Actual Length
2. Specific Term ID, Actual Code ID, Universal Length
3. Specific Term ID, Universal Code ID, Actual Length
4. Specific Term ID, Universal Code ID, Universal Length
5. Universal Term ID, Actual Code ID, Actual Length
6. Universal Term ID, Actual Code ID, Universal Length
7. Universal Term ID, Universal Code ID, Actual Length
8. Universal Term ID, Universal Code ID, Universal Length

If you have changed data format settings, and wish to clear all formats and return to the factory defaults, scan the **Default Data Format** code on [page 6-4](#).

To Add a Data Format

Step 1. Scan the **Enter Data Format** symbol ([page 6-4](#)).

Step 2. Primary/Alternate Format

Determine if this will be your primary data format, or one of 3 alternate formats. (Alternate formats allow you "single shot" capability to scan one bar code using a different data format. After the one bar code has been read, the imager reverts to the primary data format. See [page 6-5](#).) If you are programming the primary format, scan **0** using the [Programming Chart](#) inside the back cover of this manual. If you are programming an alternate format, scan **1**, **2**, or **3**, depending on the alternate format you are programming.

Step 3. Terminal Type

Refer to [Supported Terminals](#) (page 2-8) and locate the Terminal ID number for your PC. Scan three numeric bar codes on the inside back cover to program the imager for your terminal ID (you must enter 3 digits). For example, scan **0 0 3** for an AT wedge.

Note: The wildcard for all terminal types is 099.

Step 4. Code I.D.

In [Appendix A](#), find the symbology to which you want to apply the data format. Locate the Hex value for that symbology and scan the 2 digit hex value from the [Programming Chart](#) inside the back cover of this manual.

Step 5. Length

Specify what length (up to 9999 characters) of data will be acceptable for this symbology. Scan the four digit data length from the [Programming Chart](#) inside the back cover of this manual. (Note: 50 characters is entered as 0050. 9999 is a universal number, indicating all lengths.)

Step 6. Editor Commands

Refer to [Data Format Editor Commands](#) (page 6-2). Scan the symbols that represent the command you want to enter. 94 alphanumeric characters may be entered for each symbology data format.

Step 7. Scan **Save** from the [Programming Chart](#) inside the back cover of this manual to save your entries.

Other Programming Selections

- **Clear One Data Format**

This deletes one data format for one symbology. If you are clearing the primary format, scan **0** from the [Programming Chart](#) inside the back cover of this manual. If you are clearing an alternate format, scan **1**, **2**, or **3**, depending on the alternate format you are clearing. Scan the Terminal Type and Code I.D. (see [Supported Terminals](#) on page 2-8), and the bar code data length for the specific data format that you want to delete. All other formats remain unaffected.

- **Save** from the [Programming Chart](#) inside the back cover of this manual
This exits, saving any Data Format changes.

- **Discard** from the [Programming Chart](#) inside the back cover of this manual
This exits without saving any Data Format changes.

Data Format Editor Commands

Send Commands

F1 Send all characters followed by “xx” key or function code, starting from current cursor position. **Syntax = F1xx** (xx stands for the hex value for an ASCII code, see [Code Page Mapping of Printed Bar Codes](#) on page A-6.)

F2 Send “nn” characters followed by “xx” key or function code, starting from current cursor position. **Syntax = F2nnxx** (nn stands for the numeric value (00-99) for the number of characters and xx stands for the hex value for an ASCII code. See [Code Page Mapping of Printed Bar Codes](#) on page A-6.)

F3 Send up to but not including “ss” character (Search and Send) starting from current cursor position, leaving cursor pointing to “ss” character followed by “xx” key or function code. **Syntax = F3ssxx** (ss and xx both stand for the

hex values for ASCII codes, see [Code Page Mapping of Printed Bar Codes](#) on page A-6.)

- F4 Send “xx” character “nn” times (Insert) leaving cursor in current cursor position. **Syntax = F4xxnn** (xx stands for the hex value for an ASCII code, see [Code Page Mapping of Printed Bar Codes](#) on page A-6, and nn is the numeric value (00-99) for the number of times it should be sent.)
- E9 Send all but the last “nn” characters, starting from the current cursor position. **Syntax = E9nn** (nn is the numeric value (00-99) for the number of characters that will not be sent at the end of the message.)

Move Commands

- F5 Move the cursor ahead “nn” characters from current cursor position. **Syntax = F5nn** (nn stands for the numeric value (00-99) for the number of characters the cursor should be moved ahead.)
- F6 Move the cursor back “nn” characters from current cursor position. **Syntax = F6nn** (nn stands for the numeric value (00-99) for the number of characters the cursor should be moved back.)
- F7 Move the cursor to the beginning of the data string. **Syntax = F7.**
- EA Move the cursor to the end of the data string. **Syntax = EA**

Search Commands

- F8 Search ahead for “xx” character from current cursor position, leaving cursor pointing to “xx” character. **Syntax = F8xx** (xx stands for the hex value for an ASCII code, see [Code Page Mapping of Printed Bar Codes](#) on page A-6.)
- F9 Search back for “xx” character from current cursor position, leaving cursor pointing to “xx” character. **Syntax = F9xx** (xx stands for the hex value for an ASCII code, see [Code Page Mapping of Printed Bar Codes](#) on page A-6.)
- E6 Search ahead for the first non “xx” character from the current cursor position, leaving cursor pointing to non “xx” character. **Syntax = E6xx** (xx stands for the hex value for an ASCII code, see [Code Page Mapping of Printed Bar Codes](#) on page A-6.)
- E7 Search back for the first non “xx” character from the current cursor position, leaving cursor pointing to non “xx” character. **Syntax = E7xx** (xx stands for the hex value for an ASCII code, see [Code Page Mapping of Printed Bar Codes](#) on page A-6.)

Miscellaneous Commands

- FB Suppress all occurrences of up to 15 different characters, starting at the current cursor position, as the cursor is advanced by other commands. When the FC command is encountered, the suppress function is terminated. The cursor is not moved by the FB command. **Syntax = FBnnxxyy .zz** where nn is a count of the number of suppressed characters in the list and xxyy .zz is the list of characters to be suppressed. (xx stands for the hex value for an ASCII code, see [Code Page Mapping of Printed Bar Codes](#) on page A-6.)
- FC Disables suppress filter and clear all suppressed characters. **Syntax = FC.**

- E4 Replaces up to 15 characters in the data string with user specified characters. Replacement continues until the E5 command is encountered. **Syntax = E4nnxx₁xx₂yy₁yy₂...zz₁zz₂** where nn is the total count of both characters to be replaced plus replacement characters; xx₁ defines characters to be replaced and xx₂ defines replacement characters, continuing through zz₁ and zz₂.
- E5 Terminates character replacement. **Syntax = E5.**
- FE Compare character in current cursor position to the character "xx." If characters are equal, increment cursor. If characters are not equal, no format match. **Syntax = FExx** (xx stands for the hex value for an ASCII code, see [Code Page Mapping of Printed Bar Codes](#) on page A-6.)
- EC Check to make sure there is an ASCII number at the current cursor position. If character is not numeric, format is aborted. **Syntax = EC.**
- ED Check to make sure there is a non-numeric ASCII character at the current cursor position. If character is numeric, format is aborted. **Syntax = ED.**

Data Format Editor



Enter Data Format



* Default Data Format



Clear One Data Format



Clear All Data Formats



Save



Discard

Data Formatter

When Data Formatter is turned off, the bar code data is output to the host as read (including prefixes and suffixes). Choose one of the following options. *Default = Data Formatter On, but Not Required.*



* Data Formatter On,
but Not Required



Data Formatter Off

When Data Formatter is required, all input data must conform to an edited format or the imager does not transmit the input data to the host device.



Data Format On, Format Required

Alternate Data Formats

Alternate formats allow you “single shot” capability to scan one bar code using a different data format than your primary format. When data formats are programmed (see page 6-1), you must input whether you are programming the primary format, or an alternate format numbered 1, 2, or 3.

An alternate format is initiated by scanning one of the 3 alternate format bar codes below. The imager will scan the next bar code, formatting the data with the selected alternate format, then revert immediately to the primary format.



Alternate Data Format 1



Alternate Data Format 2



Alternate Data Format 3



Symbologies

This programming section contains the following menu selections. Refer to [Chapter 12](#) for settings and defaults.

- All Symbologies
- 4-CB (4-State Customer Bar Code)
- Australian Post
- Aztec Code
- British Post
- Canadian Post
- China Post
- Codabar
- Codablock F
- Code 11
- Code 128
- Code 16K
- Code 39
- Code 49
- Code 93
- Data Matrix
- EAN/JAN-13
- EAN/JAN-8
- EAN•UCC Composite Codes
- Interleaved 2 of 5
- ID-tag (UPU 4-State)
- Japanese Post
- Kix (Netherlands) Post
- Korea Post
- Matrix 2 of 5
- MaxiCode
- MicroPDF417
- MSI
- PDF417
- Planet Code
- Plessey Code
- PosiCode A and B
- Postnet
- QR Code
- RSS Expanded
- RSS Limited
- RSS-14
- Straight 2 of 5 IATA
- Straight 2 of 5 Industrial
- TCIF Linked Code 39 (TLC39)
- Telepen
- UPC-A
- UPC-A/EAN-13 with Extended Coupon Code

All Symbologies

If you want to decode all the symbologies allowable for your imager, scan the **All Symbologies On** code. If on the other hand, you want to decode only a particular symbology, scan All Symbologies Off followed by the On symbol for that particular symbology.



All Symbologies On



All Symbologies Off

Message Length Description

You are able to set the valid reading length of some of the bar code symbologies. If the data length of the scanned bar code doesn't match the valid reading length, the imager will issue an error beep. You may wish to set the same value for minimum and maximum length to force the imager to read fixed length bar code data. This helps reduce the chances of a misread.

EXAMPLE: Decode only those bar codes with a count of 9-20 characters.
Min. length = 09 Max. length = 20

EXAMPLE: Decode only those bar codes with a count of 15 characters.
Min. length = 15 Max. length = 15

For a value other than the minimum and maximum message length defaults, scan the bar codes included in the explanation of the symbology, then scan the digit value of the message length and **Save** bar codes on the [Programming Chart](#) inside the back cover of this manual. The minimum and maximum lengths and the defaults are included with the respective symbologies.

Codabar

<Default All Codabar Settings>



Codabar



* On



Off

Codabar Start/Stop Characters

Start/Stop characters identify the leading and trailing ends of the bar code. You may either transmit, or not transmit Start/Stop characters.

Default = Don't Transmit.



Transmit



* Don't Transmit

Codabar Check Character

Codabar check characters are created using different “modulos.” You can program the imager to read only Codabar bar codes with Modulo 16 check characters. *Default = No Check Character.*

No Check Character indicates that the imager reads and transmits bar code data with or without a check character.

When Check Character is set to **Validate and Transmit**, the imager will only read Codabar bar codes printed with a check character, and will transmit this character at the end of the scanned data.

When Check Character is set to **Validate, but Don't Transmit**, the unit will only read Codabar bar codes printed **with** a check character, but will not transmit the check character with the scanned data.



* No Check Character



Validate Modulo 16, but Don't Transmit



Validate Modulo 16 and Transmit

Codabar Concatenation

Codabar supports symbol concatenation. When you enable concatenation, the imager looks for a Codabar symbol having a "D" start character, adjacent to a symbol having a "D" stop character. In this case the two messages are concatenated into one with the "D" characters omitted. *Default = On.*



Select Require to prevent the imager from decoding a single "D" Codabar symbol without its companion. This selection has no effect on Codabar symbols without Stop/Start D characters.



On



* Off



Require

Codabar Message Length

Scan the bar codes below to change the message length. Refer to [Message Length Description](#) (page 7-2) for additional information. Minimum and Maximum lengths = 2-60. Minimum Default = 4, Maximum Default = 60.



Minimum Message Length



Maximum Message Length

Code 39

< Default All Code 39 Settings >



Code 39



* On



Off

Code 39 Start/Stop Characters

Start/Stop characters identify the leading and trailing ends of the bar code. You may either transmit, or not transmit Start/Stop characters. *Default = Don't Transmit.*



Transmit



* Don't Transmit

Code 39 Check Character

No Check Character indicates that the imager reads and transmits bar code data with or without a check character.

When Check Character is set to **Validate, but Don't Transmit**, the unit only reads Code 39 bar codes printed with a check character, but will not transmit the check character with the scanned data.

When Check Character is set to **Validate and Transmit**, the imager only reads Code 39 bar codes printed with a check character, and will transmit this character at the end of the scanned data. *Default = No Check Character.*



* No Check Character



Validate, but Don't Transmit



Validate and Transmit

Code 39 Message Length

Scan the bar codes below to change the message length. Refer to [Message Length Description](#) (page 7-2) for additional information. Minimum and Maximum lengths = 0-48. Minimum Default = 0, Maximum Default = 48.



Minimum Message Length



Maximum Message Length

Code 39 Append

This function allows the imager to append the data from several Code 39 bar codes together before transmitting them to the host computer. When this function is enabled, the imager stores those Code 39 bar codes that start with a space (excluding the start and stop symbols), and does not immediately transmit the data. The imager stores the data in the order in which the bar codes are read, deleting the first space from each. The imager transmits the appended data when it reads a Code 39 bar code that starts with a character other than a space. *Default = Off.*



On



* Off

Code 32 Pharmaceutical (PARAF)

Code 32 Pharmaceutical is a form of the Code 39 symbology used by Italian pharmacies. This symbology is also known as PARAF.

Note: *Trioptic Code (page 7-34) must be turned off while scanning Code 32 Pharmaceutical codes.*



On



* Off

Full ASCII

If Full ASCII Code 39 decoding is enabled, certain character pairs within the bar code symbol will be interpreted as a single character. For example: \$V will be decoded as the ASCII character SYN, and /C will be decoded as the ASCII character #. *Default = Off.*

NUL %U	DLE \$P	SP SPACE	0 0	@ %V	P P	' %W	p +P
SOH \$A	DC1 \$Q	! /A	1 1	A A	Q Q	a +A	q +Q
STX \$B	DC2 \$R	" /B	2 2	B B	R R	b +B	r +R
ETX \$C	DC3 \$S	# /C	3 3	C C	S S	c +C	s +S
EOT \$D	DC4 \$T	\$ /D	4 4	D D	T T	d +D	t +T
ENQ \$E	NAK \$U	% /E	5 5	E E	U U	e +E	u +U
ACK \$F	SYN \$V	& /F	6 6	F F	V V	f +F	v +V
BEL \$G	ETB \$W	' /G	7 7	G G	W W	g +G	w +W
BS \$H	CAN \$X	(/H	8 8	H H	X X	h +H	x +X
HT \$I	EM \$Y) /I	9 9	I I	Y Y	i +I	y +Y
LF \$J	SUB \$Z	* /J	: /Z	J J	Z Z	j +J	z +Z
VT \$K	ESC %A	+ /K	; %F	K K	[%K	k +K	{ %P
FF \$L	FS %B	, /L	< %G	L L	\ %L	l +L	%Q
CR \$M	GS %C	- -	= %H	M M] %M	m +M	} %R
SO \$N	RS %D	. .	> %I	N N	^ %N	n +N	~ %S
SI \$O	US %E	/ /O	? %J	O O	_ %O	o +O	DEL %T

Character pairs /M and /N decode as a minus sign and period respectively.
Character pairs /P through /Y decode as 0 through 9.



Full ASCII On



* Full ASCII Off

Code 39 Code Page

Code pages define the mapping of character codes to characters. If the data received does not display with the proper characters, it may be because the bar code being scanned was created using a code page that is different from the one the host program is expecting. If this is the case, scan the bar code below, select the code page with which the bar codes were created (see [Code Page Mapping of Printed Bar Codes](#) on page A-6), and scan the value and the **Save** bar code from the [Programming Chart](#) on the inside the back cover of this manual. The data characters should then appear properly.



Code 39 Code Page

Interleaved 2 of 5

< Default All Interleaved 2 of 5 Settings >



Interleaved 2 of 5



* On



Off

Check Digit

No Check Digit indicates that the imager reads and transmits bar code data with or without a check digit.

When Check Digit is set to **Validate, but Don't Transmit**, the unit only reads Interleaved 2 of 5 bar codes printed with a check digit, but will not transmit the check digit with the scanned data.

When Check Digit is set to **Validate and Transmit**, the imager only reads Interleaved 2 of 5 bar codes printed with a check digit, and will transmit this digit at the end of the scanned data. *Default = No Check Digit.*



* No Check Digit



Validate, but Don't Transmit



Validate and Transmit

Interleaved 2 of 5 Message Length

Scan the bar codes below to change the message length. Refer to [Message Length Description](#) (page 7-2) for additional information. Minimum and Maximum lengths = 2-80. Minimum Default = 4, Maximum Default = 80.



Minimum Message Length



Maximum Message Length

Code 93

< *Default All Code 93 Settings* >



Code 93



* On



Off

Code 93 Message Length

Scan the bar codes below to change the message length. Refer to [Message Length Description](#) (page 7-2) for additional information. Minimum and Maximum lengths = 0-80. Minimum Default = 0, Maximum Default = 80.



Minimum Message Length



Maximum Message Length

Code 93 Code Page

Code pages define the mapping of character codes to characters. If the data received does not display with the proper characters, it may be because the bar code being scanned was created using a code page that is different from the one the host program is expecting. If this is the case, scan the bar code below, select the code page with which the bar codes were created (see [Code Page Mapping of Printed Bar Codes](#) on page A-6), and scan the value and the **Save** bar code from the [Programming Chart](#) on the inside the back cover of this manual. The data characters should then appear properly.



Code 93 Code Page

Straight 2 of 5 Industrial (three-bar start/stop)

<Default All Straight 2 of 5 Industrial Settings>



Straight 2 of 5 Industrial



On



* Off

Straight 2 of 5 Industrial Message Length

Scan the bar codes below to change the message length. Refer to [Message Length Description](#) (page 7-2) for additional information. Minimum and Maximum lengths = 1-48. Minimum Default = 4, Maximum Default = 48.



Minimum Message Length



Maximum Message Length

Straight 2 of 5 IATA (two-bar start/stop)

<Default All Straight 2 of 5 IATA Settings>



Straight 2 of 5 IATA



On



* Off

Straight 2 of 5 IATA Message Length

Scan the bar codes below to change the message length. Refer to [Message Length Description](#) (page 7-2) for additional information. Minimum and Maximum lengths = 1-48. Minimum Default = 4, Maximum Default = 48.



Minimum Message Length



Maximum Message Length

Matrix 2 of 5

<Default All Matrix 2 of 5 Settings>



Matrix 2 of 5



On



* Off

Matrix 2 of 5 Message Length

Scan the bar codes below to change the message length. Refer to [Message Length Description](#) (page 7-2) for additional information. Minimum and Maximum lengths = 1-80. Minimum Default = 4, Maximum Default = 80.



Minimum Message Length



Maximum Message Length

Code 11

<Default All Code 11 Settings>



Code 11



On



* Off

Check Digits Required

This option sets whether 1 or 2 check digits are required with Code 11 bar codes.
Default = Two Check Digits.



One Check Digit



* Two Check Digits

Code 11 Message Length

Scan the bar codes below to change the message length. Refer to [Message Length Description](#) (page 7-2) for additional information. Minimum and Maximum lengths = 1-80. Minimum Default = 4, Maximum Default = 80.



Minimum Message Length



Maximum Message Length

Code 128

<Default All Code 128 Settings>



Code 128



ISBT 128 Concatenation

In 1994 the International Society of Blood Transfusion (ISBT) ratified a standard for communicating critical blood information in a uniform manner. The use of ISBT formats requires a paid license. The ISBT 128 Application Specification describes 1) the critical data elements for labeling blood products, 2) the current recommendation to use Code 128 due to its high degree of security and its space-efficient design, 3) a variation of Code 128 that supports concatenation of neighboring symbols, and 4) the standard layout for bar codes on a blood product label. Use the bar codes below to turn concatenation on or off. *Default =Off.*



Code 128 Message Length

Scan the bar codes below to change the message length. Refer to [Message Length Description](#) (page 7-2) for additional information. Minimum and Maximum lengths = 0-80. Minimum Default = 0, Maximum Default = 80.



Code 128 Code Page

Code pages define the mapping of character codes to characters. If the data received does not display with the proper characters, it may be because the bar code being scanned was created using a code page that is different from the one the host program is expecting. If this is the case, scan the bar code below, select the code page with which the bar codes were created (see [Code Page Mapping of Printed Bar Codes](#) on page A-6), and scan the value and the **Save** bar code from the [Programming Chart](#) on the inside the back cover of this manual. The data characters should then appear properly.



Code 128 Code Page

Telepen

<Default All Telepen Settings>



Telepen



On



* Off

Telepen Output

Using AIM Telepen Output, the imager reads symbols with start/stop pattern 1 and decodes them as standard full ASCII (start/stop pattern 1). When Original Telepen Output is selected, the imager reads symbols with start/stop pattern 1 and decodes them as compressed numeric with optional full ASCII (start/stop pattern 2). *Default = AIM Telepen Output.*



* AIM Telepen Output



Original Telepen Output

Telepen Message Length

Scan the bar codes below to change the message length. Refer to [Message Length Description](#) (page 7-2) for additional information. Minimum and Maximum lengths = 1-60. Minimum Default = 1, Maximum Default = 60.



Minimum Message Length



Maximum Message Length

UPC-A

<Default All UPC-A Settings>



UPC-A



* On



Off

UPC-A Check Digit

This selection allows you to specify whether the check digit should be transmitted at the end of the scanned data or not. *Default = On.*



* On



Off

UPC-A Number System

The numeric system digit of a U.P.C. symbol is normally transmitted at the beginning of the scanned data, but the unit can be programmed so it will not transmit it. *Default = On.*



* On



Off

UPC-A Addenda

This selection adds 2 or 5 digits to the end of all scanned UPC-A data.
Default = Off for both 2 Digit Addenda and 5 Digit Addenda.



2 Digit Addenda On



* 2 Digit Addenda Off



5 Digit Addenda On



* 5 Digit Addenda Off

UPC-A Addenda Required

When **Required** is scanned, the imager will only read UPC-A bar codes that have addenda. You must then turn on a 2 or 5 digit addenda listed on [page 7-21](#). *Default = Not Required.*



Required



* Not Required

UPC-A Addenda Separator

When this feature is on, there is a space between the data from the bar code and the data from the addenda. When turned off, there is no space.
Default = On.



* On



Off

UPC-A/EAN-13 ***with Extended Coupon Code***

Use the following codes to enable or disable UPC-A **and** EAN-13 with Extended Coupon Code. *Default = On.*



* On



Off

UPC-E0

<Default All UPC-E Settings>



UPC-E0

Most U.P.C. bar codes lead with the 0 number system. For these codes, use the UPC-E0 selection. If you need to read codes that lead with the 1 number system, use [UPC-E1](#) (page 7-25). *Default = On.*



* UPC-E0 On



UPC-E0 Off

UPC-E0 Expand

UPC-E Expand expands the UPC-E code to the 12 digit, UPC-A format.
Default = Off.



On



* Off

UPC-E0 Addenda Required

When Addenda Required is set to on, the imager will only read UPC-E bar codes that have addenda. *Default = Not Required.*



Required



* Not Required

UPC-E0 Addenda Separator

When this feature is on, there is a space between the data from the bar code and the data from the addenda. When turned off, there is no space.
Default = On.



* On



Off

UPC-E0 Check Digit

Check Digit specifies whether the check digit should be transmitted at the end of the scanned data or not. *Default = On.*



UPC-E0 Number System

The numeric system digit of a U.P.C. symbol is normally transmitted at the beginning of the scanned data, but the unit can be programmed so it will not transmit it. *Default = On.*



UPC-E0 Addenda

This selection adds 2 or 5 digits to the end of all scanned UPC-E data. *Default = Off for both 2 Digit and 5 Digit Addenda.*



UPC-E1

Most U.P.C. bar codes lead with the 0 number system. For these codes, use [UPC-E0](#) (page 7-22). If you need to read codes that lead with the 1 number system, use the UPC-E1 selection. *Default = Off.*



UPC-E1 On



* UPC-E1 Off

EAN/JAN-13

<Default All EAN/JAN Settings>



EAN/JAN-13



* On



Off

EAN/JAN-13 Check Digit

This selection allows you to specify whether the check digit should be transmitted at the end of the scanned data or not. *Default = On.*



EAN/JAN-13 Addenda

This selection adds 2 or 5 digits to the end of all scanned EAN/JAN-13 data. *Default = Off for both 2 Digit and 5 Digit Addenda.*



EAN/JAN-13 Addenda Required

When Addenda Required is set to on, the imager will only read EAN/JAN-13 bar codes that have addenda. *Default = Not Required.*



EAN/JAN-13 Addenda Separator

When this feature is on, there is a space between the data from the bar code and the data from the addenda. When turned off, there is no space.

Default = On.



* On



Off

Note: If you want to enable or disable EAN13 with Extended Coupon Code, refer to [UPC-A/EAN-13 with Extended Coupon Code](#) (page 7-22).

ISBN Translate

This selection causes EAN-13 Bookland symbols to be translated into their equivalent ISBN number format. *Default = Off.*



On



* Off

EAN/JAN-8

<Default All EAN/JAN-8 Settings>



EAN/JAN-8



* On



Off

EAN/JAN-8 Check Digit

This selection allows you to specify whether the check digit should be transmitted at the end of the scanned data or not. *Default = On.*



* On



Off

EAN/JAN-8 Addenda

This selection adds 2 or 5 digits to the end of all scanned EAN/JAN-8 data. *Default = Off for both 2 Digit and 5 Digit Addenda.*



2 Digit Addenda On



* 2 Digit Addenda Off



5 Digit Addenda On



* 5 Digit Addenda Off

EAN/JAN-8 Addenda Required

When Addenda Required is set to on, the imager will only read EAN/JAN-8 bar codes that have addenda. *Default = Not Required.*



Required



* Not Required

EAN/JAN-8 Addenda Separator

When this feature is on, there is a space between the data from the bar code and the data from the addenda. When turned off, there is no space. *Default = On.*



* On



Off

MSI

<Default All MSI Settings>



MSI



On



* Off

MSI Check Character

Different types of check characters are used with MSI bar codes. You can program the imager to read MSI bar codes with Type 10 check characters. *Default = Validate Type 10, but Don't Transmit.*

When Check Character is set to **Validate and Transmit**, the imager will only read MSI bar codes printed with the specified type check character, and will transmit this character at the end of the scanned data.

When Check Character is set to **Validate, but Don't Transmit**, the unit will only read MSI bar codes printed with the specified type check character, but will not transmit the check character with the scanned data.



* Validate Type 10, but Don't
Transmit



Validate Type 10 and Transmit

MSI Message Length

Scan the bar codes below to change the message length. Refer to [Message Length Description](#) (page 7-2) for additional information. Minimum and Maximum lengths = 4-48. Minimum Default = 4, Maximum Default = 48.



Minimum Message Length



Maximum Message Length

Plessey Code

<Default All Plessey Code Settings>



Plessey Code



On



* Off

Plessey Message Length

Scan the bar codes below to change the message length. Refer to [Message Length Description](#) (page 7-2) for additional information. Minimum and Maximum lengths = 4-48. Minimum Default = 4, Maximum Default = 48.



Minimum Message Length



Maximum Message Length

RSS-14

< Default All RSS-14 Settings >



RSS-14



* On



Off

RSS Limited

< Default All RSS Limited Settings >



RSS Limited



* On



Off

RSS Expanded

< Default All RSS Expanded Settings >



RSS Expanded



* On



Off

RSS Expanded Message Length

Scan the bar codes below to change the message length. Refer to [Message Length Description](#) (page 7-2) for additional information. Minimum and Maximum lengths = 4-74. Minimum Default = 4, Maximum Default = 74.



Minimum Message Length



Maximum Message Length

PosiCode

<Default All PosiCode Settings>



PosiCode A and B



* On



Off

You have to have PosiCode A and B on to read any of the PosiCode symbologies.



A and B On
(No Limited)



A and B and Limited A On
(Limited B Off)



* A and B and Limited B On
(Limited A Off)

PosiCode Message Length

Scan the bar codes below to change the message length. Refer to [Message Length Description](#) (page 7-2) for additional information. Minimum and Maximum lengths = 2-80. Minimum Default = 4, Maximum Default = 48.



Minimum Message Length



Maximum Message Length

Trioptic Code

Note: If you are going to scan Code 32 Pharmaceutical codes (page 7-8), Trioptic Code must be off.

Trioptic Code is used for labeling magnetic storage media.



On



* Off

Codablock F

<Default All Codablock F Settings>



Codablock F



On



* Off

Codablock F Message Length

Scan the bar codes below to change the message length. Refer to [Message Length Description](#) (page 7-2) for additional information. Minimum and Maximum lengths = 1-2048. Minimum Default = 1, Maximum Default = 2048.



Minimum Message Length



Maximum Message Length

Code 16K

<Default All Code 16K Settings>



Code 16K



On



* Off

Code 16K Message Length

Scan the bar codes below to change the message length. Refer to [Message Length Description](#) (page 7-2) for additional information. Minimum and Maximum lengths = 0-160. Minimum Default = 1, Maximum Default = 160.



Minimum Message Length



Maximum Message Length

Code 49

<Default All Code 49 Settings>



Code 49



* On



Off

Code 49 Message Length

Scan the bar codes below to change the message length. Refer to [Message Length Description](#) (page 7-2) for additional information. Minimum and Maximum lengths = 1-81. Minimum Default = 1, Maximum Default = 81.



Minimum Message Length



Maximum Message Length

PDF417

< Default All PDF417 Settings >



PDF417



* On



Off

PDF417 Message Length

Scan the bar codes below to change the message length. Refer to [Message Length Description](#) (page 7-2) for additional information. Minimum and Maximum lengths = 1-2750. Minimum Default = 1, Maximum Default = 2750.



Minimum Message Length



Maximum Message Length

MicroPDF417

< Default All MicroPDF417 Settings >



MicroPDF417



On



* Off

MicroPDF417 Message Length

Scan the bar codes below to change the message length. Refer to [Message Length Description](#) (page 7-2) for additional information. Minimum and Maximum lengths = 1-366. Minimum Default = 1, Maximum Default = 366.



Minimum Message Length



Maximum Message Length

EAN•UCC Composite Codes

Linear codes are combined with a unique 2D composite component to form a new class called EAN•UCC Composite symbology. EAN•UCC Composite symbologies allow for the co-existence of symbologies already in use.



On



* Off

UPC/EAN Version

Scan the **UPC/EAN Version On** bar code to decode EAN•UCC Composite symbols that have a UPC or EAN linear component. (This does not affect EAN•UCC Composite symbols with a UCC/EAN-128 or RSS linear component.)



UPC/EAN Version On



* UPC/EAN Version Off

EAN•UCC Composite Code Message Length

Scan the bar codes below to change the message length. Refer to [Message Length Description](#) (page 7-2) for additional information. Minimum and Maximum lengths = 1-2435. Minimum Default = 1, Maximum Default = 2435.



Minimum Message Length



Maximum Message Length

EAN•UCC Emulation

The imager can automatically format the output from any EAN•UCC data carrier to emulate what would be encoded in an equivalent UCC/EAN-128 or RSS and Composite symbol. EAN•UCC data carriers include UPC-A and UPC-E, EAN-13 and EAN-8, ITF-14, UCC/EAN-128, and EAN•UCC RSS and Composites. Data from 2D symbols such as Aztec Code, Data Matrix, or QR Code, which encode a leading FNC1, also invoke EAN•UCC emulation. If UCC/EAN-128 Emulation is selected, the AIM Symbology Identifier is reported as “jC1”. If RSS Emulation is selected, the AIM Symbology Identifier is reported as “je0.” Any application that accepts EAN•UCC data can be simplified since it only needs to recognize one data carrier type. *Default = No Emulation.*



RSS Emulation



128 Emulation



* EAN•UCC Emulation Off

TCIF Linked Code 39 (TLC39)

This code is a composite code since it has a Code 39 linear component and a MicroPDF417 stacked code component. All bar code readers are capable of reading the Code 39 linear component. The MicroPDF417 component can only be decoded if **TLC39 On** is selected. The linear component may be decoded as Code 39 even if TLC39 is off.



On



* Off

Postal Codes

Note: For best performance when reading a postal symbology, all other postal symbologies should be turned off. The following postal codes can only be read by a 2D imager.

4-CB (4-State Customer Bar Code)



On



* Off

ID-tag (UPU 4-State)



On



* Off

Postnet



On



* Off

Postnet Check Digit

This selection allows you to specify whether the check digit should be transmitted at the end of the scanned data.



Transmit Check Digit



* Don't Transmit Check Digit

Planet Code



On



* Off

Planet Code Check Digit

This selection allows you to specify whether the check digit should be transmitted at the end of the scanned data.



Transmit Check Digit



* Don't Transmit Check Digit

British Post



Canadian Post



Kix (Netherlands) Post

Note: Kix code can misread when scanned sideways or upside down. Use [Working Orientation](#), page 4-19, if your Kix codes will not usually be presented upright to the imager.



Australian Post





Australian Post Interpretation

This option controls what interpretation is applied to customer fields in Australian 4-State symbols. Bar Output lists the bar patterns in "0123" format. Numeric N Table causes that field to be interpreted as numeric data using the N Table. Alphanumeric C Table causes the field to be interpreted as alphanumeric data using the C Table. Refer to the Australian Post Specification Tables.



* Bar Output



Numeric N Table



Alphanumeric C Table

Japanese Post



On



* Off

China Post

<Default All China Post Settings>



China Post



On



* Off

China Post Message Length

Scan the bar codes below to change the message length. Refer to [Message Length Description](#) (page 7-2) for additional information. Minimum and Maximum lengths = 2-80. Minimum Default = 4, Maximum Default = 80.



Minimum Message Length



Maximum Message Length

Korea Post

<Default All Korea Post Settings>



Korea Post



On



* Off

Korea Post Message Length

Scan the bar codes below to change the message length. Refer to [Message Length Description](#) (page 7-2) for additional information. Minimum and Maximum lengths = 2-80. Minimum Default = 4, Maximum Default = 48.



Minimum Message Length



Maximum Message Length

QR Code

< Default All QR Code Settings >



QR Code

This selection applies to both QR Code and Micro QR Code.



* On



Off

QR Code Message Length

Scan the bar codes below to change the message length. Refer to [Message Length Description](#) (page 7-2) for additional information. Minimum and Maximum lengths = 1-3500. Minimum Default = 1, Maximum Default = 3500.



Minimum Message Length



Maximum Message Length

Data Matrix

< *Default All Data Matrix Settings* >



Data Matrix



* On



Off

Data Matrix Message Length

Scan the bar codes below to change the message length. Refer to [Message Length Description](#) (page 7-2) for additional information. Minimum and Maximum lengths = 1-1500. Minimum Default = 1, Maximum Default = 1500.



Minimum Message Length



Maximum Message Length

MaxiCode

< Default All MaxiCode Settings >



MaxiCode



* On



Off

MaxiCode Message Length

Scan the bar codes below to change the message length. Refer to [Message Length Description](#) (page 7-2) for additional information. Minimum and Maximum lengths = 1-150. Minimum Default = 1, Maximum Default = 150.



Minimum Message Length



Maximum Message Length

Aztec Code

< *Default All Aztec Code Settings* >



Aztec Code



* On



Off

Aztec Code Message Length

Scan the bar codes below to change the message length. Refer to [Message Length Description](#) (page 7-2) for additional information. Minimum and Maximum lengths = 1-3750. Minimum Default = 1, Maximum Default = 3750.



Minimum Message Length



Maximum Message Length

Aztec Runes

Select **Enable Runes** if you are scanning Aztec runes, which are the smallest type of Aztec Code symbol with the ability to encode a very short license plate message.



Enable Runes



* Disable Runes



Imaging Commands

The imager can be used as a digital camera for capturing, manipulating, and transferring images.

Imaging Commands with their modifiers send imaging commands to the imager on a single-use basis, and take effect for the next subsequent image capture. Once that capture is complete, the imager reverts to its imaging default settings. If you wish to change a default setting, you must use the serial default command (see [Imaging Default Commands](#) on page 12-21). When the serial default command is used, that selection becomes the new default setting for the imager.

Image Snap - IMGSNP

An image is taken whenever the trigger of the imager is pressed, or when the Image Snap (IMGSNP) command is processed. Image Snap is the command processor for image capture, or taking a picture.

The image snap command has many different modifiers that can be used to change the look of the image in memory. Modifiers always begin with numbers and end with a letter (case insensitive). Any number of modifiers may be appended to the IMGSNP command. For example, you can use the following command to snap an image, increase the gain, and have the beeper sound once the snap is complete:

IMGSNP2G1B

IMGSNP Modifiers

P - Imaging Style: Sets the Image Snap style.

- 0P **Decoding Style.** This is similar to the current format for decoding, however, this processing allows a few frames to be taken until the exposure parameters are met. Then the last frame is available for further use.
- 1P **Photo Style (default).** This attempts to mimic a simple digital camera, and results in a visually optimized image.
- 2P **Manual Style.** This is an advanced style, and should not normally be used. It allows you the most freedom to set up the imager, and has no auto-exposure.

B - Beeper: Causes a beep to sound after an image is snapped.

- 0B No beep (*default*)
- 1B Sounds a beep when the image is captured, notifying the user that the imager can be moved.

E - Exposure: This allows you to set the exposure time. Units are 127 microseconds. Exposure is used in Manual Style only. (*Default = 7874*)

- nE Range: 1 - 7874

G - Gain: This modifier boosts the signal and multiplies the pixel value.

- 1G No gain (*default*)
- 2G Medium gain
- 4G Heavy gain
- 8G Maximum gain

D - Delta for Acceptance: This sets the allowable range for the white value setting (see W - Target White Value). Delta is only available when using Photo Style. (*Default = 25*)

- nD Range: 0 - 255

L - LED State: Determines if the LEDs should be on or off, and when. Ambient illumination (0L) is preferred for taking pictures of color documents, such as ID cards, especially when the imager is in a stand. LED illumination (1L) is preferred when the imager is hand held. LED State is not available when using Decoding Style.

- 0L LEDs off (*default*)
- 1L LEDs on

T - Wait for Trigger: Waits for a hardware trigger pull before taking the image.

- 0T Takes image immediately (*default*)
- 1T Waits for a trigger pull, then takes the image. This option only works with Imaging Style 1P (Photo Style). Refer to [page 8-1](#).

U - Update Tries: The maximum number of frames the imager should take to reach the Delta for Acceptance. Update Tries is only available when using Photo Style. (*Default = 6*)

- nU Range: 0 - 10

W - Target White Value: Sets the target for the median grayscale value in the captured image. For capturing close-up images of high contrast documents, a lower setting, such as 75, is recommended. Higher settings result in longer exposure times and brighter images, but if the setting is too high, the image may be overexposed. Target White Value is only available when using Photo Style. (*Default = 125*)

- nW Range: 0 - 255

% - Target Set Point Percentage: Sets the target point for the light and dark values in the captured image. A setting of 75% means 75% of the pixels are at or below the target white value, and 25% of the pixels are above the target white value. Altering this setting from the default is not recommended under normal circumstances. To alter grayscale values, Target White Value should be used. (*Default = 50*)

- n% Range: 1 - 99

Image Ship - IMGSHIP

An image is taken whenever the trigger of the imager is pressed, or when the Image Snap (IMGSNP) command is processed. The last image is always stored in memory. You may "ship" the image by using the IMGSHIP command.

The image ship command has many different modifiers that can be used to change the look of the image output by the imager. Modifiers affect the image that is transmitted, but do not affect the image in memory. Modifiers always begin with numbers and end with a letter (case insensitive). Any number of modifiers may be appended to the IMGSHIP command. For example, you can use the following command to ship a bitmap image with gamma correction and document image filtering:

IMGSHIP8F75K26U

IMGSHIP Modifiers

A - Infinity Filter: Enhances pictures taken from very long distances (greater than 10 feet or 3 m).

- 0A Infinity filter off (*default*)
- 1A Infinity filter on

C - Compensation: Flattens the image to account for variations in illumination across the image.

- 0C Compensation disabled (*default*)
- 1C Compensation enabled

D - Pixel Depth: Indicates the number of bits per pixel in the transmitted image (KIM or BMP format only).

- 8D 8 bits per pixel, grayscale image (*default*)
- 1D 1 bit per pixel, black and white image

E - Edge Sharpen: Causes the transmitted image to be convolved with an edge sharpening filter. Entering a 23E gives the sharpest edges, but also increases noise in the image.

- 0E Don't sharpen image (*default*)
- 14E Apply edge sharpen for typical image
- ne* Apply edge sharpen using strength *n* ($n = 1-24$)

F - File Format: Indicates the desired format for the image.

- 0F KIM format
- 1F TIFF binary
- 2F TIFF binary group 4, compressed
- 3F TIFF grayscale
- 4F Uncompressed binary (upper left to lower right, 1 pixel/bit, 0 padded end of line)
- 5F Uncompressed grayscale (upper left to lower right, bitmap format)
- 6F JPEG image (*default*)
- 8F BMP format (lower right to upper left, uncompressed)

H - Histogram Stretch: Increases the contrast of the transmitted image. Not available with some image formats.

0H No stretch (*default*)

1H Histogram stretch

I - Invert Image: Used to rotate the image around the X or Y axis in fixed mount applications where the imager is mounted upside down.

1IX Invert around the X axis (flips picture upside down)

1IY Invert around the Y axis (flips picture left to right)

IF- Noise Reduction: Used to reduce the salt and pepper noise.

0IF No salt and pepper noise reduction (*default*)

1IF Salt and pepper noise reduction

IR - Image Rotate:

0IR Image as snapped (rightside up) (*default*)

1IR Rotate image 90 degrees to the right

2IR Rotate image 180 degrees (upside down)

3IR Rotate image 90 degrees to the left

J - JPEG Image Quality: Sets the desired quality when the JPEG image format is selected. Higher numbers result in higher quality, but larger files. Smaller numbers result in greater amounts of lossy compression, faster transmission times, lower quality, but smaller files. (*Default = 50*)

*n*J Image is compressed as much as possible while preserving quality factor of *n* (*n* = 0 - 100)

0J worst quality (smallest file)

100J best quality (largest file)

K - Gamma Correction: Gamma measures the brightness of midtone values produced by the image. You can brighten or darken an image using gamma correction. A higher gamma correction yields an overall brighter image. The lower the setting, the darker the image. A setting of 100 results in no adjustment to the image. The optimal setting for text images is 50K.

0K Gamma correction off (*default*)

50K Apply gamma correction for brightening typical document image

*n*K Apply gamma correction factor *n* (*n* = 1-255)

L, R, T, B, M - Image Cropping: Ships a window of the image by specifying the left, right, top, and bottom pixel coordinates. Device columns are numbered 0 through 639, and device rows are numbered 0 through 479. The resulting cropped image must have two or more rows and two or more columns of pixels or the IMGSHIP command will fail (1x1 is not acceptable). For example, sending IMGSHIP10L15R5T8B will cause a 6 column by 4 row image to be transmitted.

- nL* The left edge of the shipped image corresponds to column *n* of the image in memory. Range: 000 - 639. (Default = 0)
- nR* The right edge of the shipped image corresponds to column *n* - 1 of the image in memory. Range: 000 - 639. (Default = all columns, or 639 for VGA imager)
- nT* The top edge of the shipped image corresponds to row *n* of the image in memory. Range: 000 - 479. (Default = 0)
- nB* The bottom edge of the shipped image corresponds to row *n* - 1 of the image in memory. Range: 000 - 479. (Default = all rows, or 479 for VGA imager)

Alternately, specify the number of pixels to cut from the outside margin of the image; thus only the center pixels are transmitted.

- nM* Margin: cut *n* columns from the left, *n* + 1 columns from the right, *n* rows from the top, and *n* + 1 rows from the bottom of the image. Ship the remaining center pixels. Range: 1 - 238. (Default = 0, or full image)

P - Protocol: Used for shipping an image. Protocol covers two features of the image data being sent to the host. It addresses the protocol used to send the data (Hmodem, which is an Xmodem 1K variant that has additional header information), and the format of the image data that is sent.

- 0P None (raw data)
- 2P None (default for USB)
- 3P Hmodem compressed (default for RS-232)
- 4P Hmodem

S - Pixel Ship: Can be used to decimate the image by shipping only certain, regularly spaced pixels. For example, **4S** would transmit every fourth pixel from every fourth line. The smaller number of pixels shipped, the smaller the image. However, after a certain point, the image becomes unusable.

- 1S ship every pixel (default)
- 2S ship every 2nd pixel, both horizontally and vertically (default)
- 3S ship every 3rd pixel, both horizontally and vertically

U - Document Image Filter: Sharpens the edges and smooths the area between the edges of the transmitted text image. The Document Image Filter enhances images of documents such as ID cards and prescriptions. This filter should be used with gamma correction (see [page 8-4](#)), with the imager in a stand, and the image captured using the command:

IMG SNP1POL168W90%32D

This filter typically provides better JPEG compression than the standard E - Edge Sharpen command (see [page 8-3](#)). This filter also works well when shipping pure black and white images (1 bit per pixel). The optimal setting is 26U.

- 0U Document image filter off (*default*)
- 26U Apply document image filter for typical document image
- nU Apply document image filter using grayscale threshold n. Use lower numbers when the image contrast is lower. 1U will have a similar effect to 22e. Range: 0-255.

V - Blur Image: Smooths transitions by averaging the pixels next to the hard edges of defined lines and shaded areas in an image.

- 0V Don't blur (*default*)
- 1V Blur

W - Histogram Ship: A histogram gives a quick picture of the tonal range of an image, or key type. A low-key image has detail concentrated in the shadows; a high-key image has detail concentrated in the highlights; and an average-key image has detail concentrated in the midtones. This modifier ships the histogram for an image.

- 0W Don't ship histogram (*default*)
- 1W Ship histogram

Image Size Compatibility

If you prefer that an image ship returns images at the sensor's native resolution (752x480 pixels for the 5X00 engine, 640x480 pixels for the 4X00 engine), scan the Native Resolution code. If you have an imager with a 4X00 image engine and have designed applications that expect an image ship to return exactly 640x480 pixels, scan the Force VGA Resolution bar code. Refer to "[Show Engine Revision](#)" on page 11-1 for information on determining the engine in your unit. *Default = Force VGA Resolution*



* Force VGA Resolution



Native Resolution

Intelligent Signature Capture - IMGBOX

Note: IMGBOX commands can only be used with PDF417, Code 39, Code 128, Aztec, Codabar, and Interleaved 2 of 5 symbologies.

Intelligent signature capture ships only part of an image to the host application. This method reduces transfer time and file size, while simplifying signature capture.

Below is an example of an intelligent signature capture application. In this example, the operator reads the bar code, which is then transmitted to the host application. Upon the receipt of the bar code data, the host application sends the IMGBOX command, which tells the imager to output only the area of the image corresponding to the signature capture box. The imager also automatically adjusts for aspect ratio and distortion, issues that arise due to imager skew with respect to the bar code.

Align the aimers with the signature area (not with the bar code), then pull the trigger. Send the IMGBOX command string after the trigger pull.



An important aspect of intelligent signature capture is that all dimensions used in the application are measured as multiples of the minimum element size of the bar code. Using this method, intelligent signature capture always outputs the correct image size and resolution, no matter the distance at which the imager is held from the bar code, assuming that the entire signature capture area is within the imager's field of view.

The intelligent signature capture command string for this application is:

IMGBOX40S0X70Y190W100H1R0F

IMGBOX Modifiers

A - Output Image Width: This option is used to output an image of a particular width. If using this option, set the resolution to zero.

B - Output Image Height: This option is used to output an image of a particular height. If using this option, set the resolution to zero.

D - Pixel Depth: Indicates the number of bits per pixel in the transmitted image.

8D 8 bits per pixel, grayscale image

1D 1 bit per pixel, black and white image

F - File Format: Indicates the type of file format in which to save the image.

- 0F KIM format (*default*)
- 1F TIFF binary
- 2F TIFF binary group 4, compressed
- 3F TIFF grayscale
- 4F Uncompressed Binary
- 5F Uncompressed grayscale
- 6F JPEG image
- 7F Outlined image
- 8F BMP format

H - Height of Signature Capture Area: In the example, the height of the area to be captured is 1 inch, resulting in a value of $H = 1/0.01 = 100$. The value for H is slightly larger, to accommodate some extra image capture area outside of the signature capture box.

K - Gamma Correction: Gamma measures the brightness of midtone values produced by the image. You can brighten or darken an image using gamma correction. A higher gamma correction yields an overall brighter image. The lower the setting, the darker the image. A setting of 100 results in no adjustment to the image. (*Default = 50K*)

- 0K Gamma correction off
- 50K Apply gamma correction for brightening typical document image
- nK Apply gamma correction factor n ($n = 1-255$)

R - Resolution of Signature Capture Area: The number of pixels that the imager outputs per each minimum bar width. The higher the value for R, the higher the quality of the image, but also the larger the file size. To specify a non-integer value for the resolution, use a number greater than or equal to 1000. For example, use 2500 to specify a resolution of 2.500. The imager automatically inserts a decimal point between the first and second digit. Set to zero when using the A and B modifiers.

S - Bar Code Aspect Ratio: The ratio of the bar code height to the narrow element width. In the example, the narrow element width is .010 inches and the bar code height is 0.400 inches, resulting in a value of $S = 0.4/0.01 = 40$.

W - Width of Signature Capture Area: In the example, the width of the area to be captured is 1.90 inches, resulting in a value of $W = 1.9/0.01 = 190$. The value for W is slightly larger, to accommodate some extra image capture area outside of the signature capture box.

X - Horizontal Bar Code Offset: The horizontal ratio offset of the center of the signature capture area, in multiples of the minimum bar width. In the example, the horizontal offset is 0.

Y - Vertical Bar Code Offset: The vertical offset of the center of the signature capture area, in multiples of the minimum bar width. Negative numbers indicate that the signature capture is above the bar code, and positive numbers indicate that the area is below the bar code. In the example, the horizontal offset is 0.70 inches, resulting in a value for $Y = 0.7/0.01 = 70$.

RF Default Imaging Device

The imager supports imaging command processing (IMGSHP, IMGSNP, IMGBOX) so that Quick*View (see "Quick*View" on page 11-5) and other applications are able to perform imaging functions as if they were talking directly to an imager. To accomplish this, the imager uses a menu command called RF_DID (RF Default Imaging Device). RF_DID is the name of the imager (BT_NAM) that is to receive imaging commands. The default for RF_DID is "*" indicating that imaging commands are to be sent to all associated imagers. Change this setting to RF_DID *imager_name* to ensure that they are sent to a particular imager. Refer to "Imager Report" on page 11-2 to generate a report containing the port, work group, imager name, and address for each imager. Refer to "Imager Name" on page 3-8 set a unique name for each imager.



OCR Programming

Use this section to program the imager for optical character recognition (OCR). The imager reads 6 to 60 point OCR typeface.

Note: OCR is not as secure as bar codes. To enhance security in OCR applications, create an OCR template to match the data and print an OCR check character.

The imager will read OCR-A, OCR-B, U.S. Currency Serial Number (Money), MICR E-13B, and SEMI Font.

You can either select an OCR default, or create your own custom template for the type of OCR format you intend to read. See "OCR" on page 9-1 for programming codes that will enable your imager to read OCR-A, OCR-B, U.S. Currency, MICR E 13 B, or SEMI fonts. See "OCR Templates" on page 9-3 if you want to create a custom "template," or character string that defines the length and content of OCR strings that will be read with your imager.

Note: Setting the template and check character options are essential for OCR reading.

OCR Fonts

Default All OCR Settings turns off all OCR capability in the imager, so the imager will be able to scan linear, stacked, matrix, and composite bar codes, but not OCR fonts. In addition, any OCR templates you have created are erased. The eight digit default templates are reinstated for any future use of the **OCR On** codes listed below.

< Default All OCR Settings >



OCR

Note: OCR symbols can misread when scanned sideways or upside down. Use [Working Orientation](#), page 4-19, if your OCR symbols will not usually be presented upright to the imager.

Only one OCR symbology can be read at a time.

OCR-A On allows you to scan characters in the OCR-A font. The default setting allows you to scan any eight digit combination. If you have created an OCR template, character combinations that fit the template can be scanned (see [Creating an OCR Template](#), page 9-4).



OCR-A On

OCR-B On allows you to scan characters in the OCR-B font. The default setting allows you to scan any eight digit combination. If you have created an OCR template, character combinations that fit the template can be scanned (see [Creating an OCR Template](#), page 9-4).



OCR-B On

U.S. Currency Font

U.S. Currency On allows you to scan characters in the font used on U.S. currency. The default setting allows you to scan any eight digit combination. If you have created an OCR template, character combinations that fit the template can be scanned (see [Creating an OCR Template](#), page 9-4).



U.S. Currency On





MICR E13 B Font

MICR E13 B On allows you to scan MICR characters on a bank check. The default setting allows you to scan any eight digit combination. If you have created an OCR template, character combinations that fit the template can be scanned (see [Creating an OCR Template](#), page 9-4).



MICR E 13 B On

Note: *TOAD* characters (*Transit, On Us, Amount and Dash*) are output in the following manner:

-  the transit character is output as **T**
-  the amount character is output as **A**
-  the on us character is output as **O**
-  the dash character is output as **D**

SEMI Font

SEMI Font On allows you to scan the SEMI font used in the semiconductor industry.



SEMI Font On

All OCR Off turns off all OCR capability in the imager, so the imager will be able to scan linear, stacked, matrix, and composite bar codes, but not OCR fonts. However, any OCR templates you have created will be retained in memory.



* All OCR Off

OCR Templates

You can create a custom “template,” or character string that defines the length and content of OCR strings that will be read with your imager. There are several choices when creating a custom template for your application. You can create a template for a single format, you can string together several formats, and you can create a template for a user-defined variable. These choices are described in detail below.

Creating an OCR Template

A single template allows you to program the imager to read any combination of characters in the order you specify. Refer to examples that follow the Template Characters table below.

Template Characters

a	represents any alphanumeric character (digit or letter)
c	represents a check character position
d	represents any digit
e	represents any available OCR character
g	represents character from user-defined variable "g"
h	represents character from user-defined variable "h"
i	represents character from user-defined variable "g" or "h"
k	represents that a check character is verified but transmitted
l	represents any uppercase letter
t	marks the start of a new template
r	multi row indicator
All other characters represent themselves. Spaces can be used. Note: In MICR E13 B templates, TOAD characters (capital letters T, O, A, and D), represent Transit, On Us, Amount, and Dash.	

Note: OCR templates default to eight digits, no check character.

To Add an OCR Template

1. Turn on the OCR font you want to read ([page 9-2](#)).
2. Begin building the template.
Scan the **Enter OCR Template** symbol ([page 9-13](#)).
3. Scan the characters for the string.
Use the Template Characters chart above to determine what characters you need to create your format. Use the [OCR Programming Chart](#) (after the Sample Codes in the back of this manual) to scan the characters for your template.

Example: You need to read any combination of eight digits. The template would be:

ddddddd

To create this template, you would enable the OCR-A font. Scan the **Enter OCR Template** symbol (page 9-13), then scan the **d** from the **OCR Programming Chart** in the back of this manual eight times. Scan **Save OCR Template** (page 9-14). This would let you read any string of eight digits, for example:

37680981

Character Match Sequences

On the [Code Page Mapping of Printed Bar Codes](#), page A-6, find the Hex value that represents the character(s) you want to match. Use the [Programming Chart](#) (inside the back cover) to scan the numbers that represent these characters.

Example: You need to read three digits, three specific characters (ABC), three digits. The template would be:

ddd414243ddd
 └───┘
 hex codes for
 letters A, B, and C

To create this template, you would enable the OCR-A font. Scan the **Enter OCR Template** symbol (page 9-13). Scan the **d** from the **OCR Programming Chart** in the back of this manual three times. Then scan **414243** from the inside back cover (the hex characters for “A,” “B,” and “C”), and scan the **d** three more times. Scan **Save OCR Template**, page 9-14. This would let you read any string of three digits, “ABC,” then any string of three digits, for example:

551ABC983

Adding Spaces

You may also need to put spaces in your template.

Example: You need to read three digits, space, three specific characters (ABC), space, three digits. The template would be:

ddd2041424320ddd
 ↓ ↓
 hex code for a space

To create this template, you would enable the OCR-A font. Scan the **Enter OCR Template** symbol (page 9-13). Scan the **d** from the **OCR Programming Chart** in the back of this manual three times, then scan **2041424320** from the **Programming Chart** on the inside back cover (the hex characters for "space," "A," "B," "C," "space"). Scan the **d** three more times, then scan **Save OCR Template** (page 9-14). This would let you read any string of three digits, space, "ABC," space, then any string of three digits. For example:

551 ABC 983

*Note: If using Quick*View to program, use the space bar to designate a space and not the hex value of 20.*

4. Exit OCR Template Editor
Scan **Save OCR Template** to save your entries. **Discard OCR Template** exits without saving any OCR Template changes.

Stringing Together Multiple Formats (Creating "Or" Statements)

You may want to program the imager to accept many OCR formats. To do this, you would string together each format with a "t." This tells the imager to read optical characters that match any one of the formats in the template.

Example: You need to read any combination of eight digits, *or* a combination of four digits, two uppercase letters, and two digits. The template would be:

dddddddtdddldd

To create this template, you would enable the OCR-A font. Scan the **Enter OCR Template** symbol (page 9-13). Scan the **d** from the **OCR Programming Chart** in the back of this manual eight times, then scan the **t** to create the "or" statement. Then you would scan the characters for the second template. Scan **d** four times, scan **l** two times, then scan **d** two more times. Scan **Save OCR Template** (page 9-14). This would let you read either type of format, for example:

99028650

or

9902XZ50

You can string together as many templates as you need.

OCR User-Defined Variables

You can create up to two of your own user variables for an OCR template. These variables will represent any OCR readable characters. The user-defined variables are stored under the letters “g” and “h.” Creating a user variable follows the same steps as creating a template, but instead of scanning the **Enter OCR Template** symbol, you scan the **Enter User-Defined Variable** symbol (page 9-13). The letters g and h can then be used in an OCR template to define the variable you specified.

Example: You need a variable to represent the letters “A,” “B,” or “C.” The template for this variable would be:

414243

To create this template, you would enable the OCR-A font. Scan the **Enter User-Defined Variable g** symbol (page 9-13). Scan **414243** from the **Programming Chart** (the hex characters for “A,” “B,” and “C”). Scan **Save OCR Template** (page 9-14). This will let you read either A or B or C in any position where you place the g. For example, you could create the following template:

ddddddggg

This template would then let you read data that began with six digits, and had an A, B, or C trailing. So you would be able to read:

654321ABC

or

654321BAC

or

654321CCC

Reading Multi-Row OCR

The imager is capable of decoding multi-row OCR text.

Note: Reading rows longer than sixteen characters is not recommended.

Consider the following example. This example shows serial commands as they would be entered using Quick*View.

Example: You need to read multiple rows of OCR-A data as shown below:

12345678

ABCDEFGH

First, enable the OCR-A font. To read the first row of OCR data, you would program the following template:

OCRTMP"ddddddd".

This template is the default OCR template. If you wanted to read the second line of data, you would use the following template:

OCRTMP"IIIIII".

To read both lines of OCR at one time, use the variable *r* to indicate the start of a new row. All the other templating variables for the individual rows work the same as previously described. For instance, in the above example, you would use the following template to read both rows:

OCRTMP"dddddddrIIIIII".

To read the three rows below, you would use the template command "OCRTMP"dddddddrIIIIIIrIIIdddd".

12345678

ABCDEFGHIH

ABCD1234

OCR Check Character

You may want to print and verify a check character in order to enhance the security of your OCR application. The imager can be programmed for almost any type of check character. A number of presets are provided for common check character uses (e.g., modulo 10 and modulo 36).

Scan the **OCR Modulo 10** or **OCR Modulo 36 Check Character** bar code to specify the type of check character used in the OCR strings you're scanning. The imager will then only read OCR character strings with a valid check character. The imager transmits the OCR data without the check character data. You must specify the location of the check character in the template with a **c**.

Example: You need to read any combination of seven digits, with a modulo 10 check character in the eighth position. The template would be:

dddddddc

To create this template, you would enable the OCR-A font. Scan the **Modulo 10 Check Character** symbol. Then scan the **Enter OCR Template** symbol, and scan the **d** from the [OCR Programming Chart](#) seven times, and scan the **c** once. Scan **Save OCR Template** (page 9-14). This template will let you read any combination of six digits with a correct check character after. (If the check character is invalid, data is discarded.) For example, the following string could be scanned:

01234569

and the output would be: 0123456

OCR Modulo 10 Check Character

Scan this symbol to program the OCR template for a simple modulo 10 checksum of the digits 0 through 9.



OCR Modulo 10 Check Character

OCR Modulo 36 Check Character

Scan this symbol to program the OCR template for a simple modulo 36 checksum of the digits 0 through 9 and the letters A through Z.



OCR Modulo 36 Check Character

OCR User-Defined Check Character

You can customize the check character calculation to suit your application. Each character of the check character alphabet can be programmed in its proper order. The number of characters you enter determines the modulo value for the calculation. By default, the check character computation is unweighted, but the imager also supports two weighted modulo 10 checking schemes.

Example: To program a modulo 11 check character, you would enter the following 11 characters in order:

0123456789X

Also enter the OCR template:

dddddddc

Enable the OCR-A font, then scan the following string:

6512351X

The imager performs the following check character computation:

$$(6 + 5 + 1 + 2 + 3 + 5 + 1 + X) \text{ modulo } 11 = 0$$

Since the result is zero, the message is considered to be valid, so the reader outputs the message: 6512351

Programming a User-Defined Check Character

1. Scan the **Enter OCR Check Character** bar code, below.



Enter OCR Check Character

2. Enter the characters in order. For each character, look up the corresponding hex value from the [Code Page Mapping of Printed Bar Codes](#) on page A-6. Use the [Programming Chart](#) on the inside the back cover of this manual to scan the two symbols for each hex value.
3. Scan the **Save** bar code on the inside back cover.

Example: To program the modulo 11 check character from example #8 on [page 9-9](#), enable the OCR-A font. Scan the **Enter OCR Check Character** bar code on [page 9-10](#), then scan the following hex values in order:

3031323334353637383958

After you enter all the desired hex values, scan the **Save** bar code on the inside back cover of this manual.

Weighting Options

By default, the check character computation is unweighted. It is possible to use one of two weighted modulo 10 schemes. Weighting is often used to detect if two neighboring characters are transposed, a common error when an operator keys in data.

3-1-3-1 Weighted Modulo 10 Check Character

Starting with the check character and working backward through the message, the imager applies a multiplier of 1, then 3, then 1, then 3, and so on. This is the checking scheme used in many EAN•UCC symbologies, including U.P.C. and Interleaved 2 of 5 (when a check digit is invoked). To apply this weighting scheme, set the OCR check character to “**0123456789x3x1**” or scan the following symbol:



3-1-3-1 Weighted Modulo 10
Check Character

Example: Scan the 3-1-3-1 Weighted Modulo 10 Check Character symbol. Also enter the OCR template:

dddddddc

Then scan the string below:

01234565

The reader performs the check character computation below:

$$(0 \times 3 + 1 \times 1 + 2 \times 3 + 3 \times 1 + 4 \times 3 + 5 \times 1 + 6 \times 3 + 5 \times 1) \text{ modulo } 10 = 0$$

Since the result is zero, the message is considered to be valid, so the reader outputs the message: 0123456

2-1-2-1 Weighted Modulo 10 Check Character

Starting with the check character and working backward through the message, the imager applies a multiplier of 1, then 2, then 1, then 2, and so on. When the result of the multiplication is greater than 9, add both digits to the running sum. This is often referred to as the LUHN formula. One common application of the LUHN formula is validate credit card numbers. This is the modulo 10 checking scheme used in MSI Code and in Code 32 Pharmaceutical (PARAF). To apply this weighting scheme, set the OCR check character to "0123456789x2x1" or scan the following symbol:



2-1-2-1 Weighted Modulo 10
Check Character

Example: Scan the 2-1-2-1 Weighted Modulo 10 Check Character symbol. Also enter the OCR template:

ddddddc

Then scan the string below:

0128454

The reader performs the check character computation below:

$$\begin{aligned} &(0 \times 1 + 1 \times 2 + 2 \times 1 + 8 \times 2 + 4 \times 1 + 5 \times 2 + 4 \times 1) \text{ modulo } 10 \\ &= (0 + 2 + 2 + (1 + 6) + 4 + (1 + 0) + 4) \text{ modulo } 10 \\ &= 0 \end{aligned}$$

Since the result is zero, the message is considered to be valid, so the reader outputs the message: 012845

OCR ISBN Application Example

One application of OCR is to read the ISBN characters typically encoded using the OCR-A or OCR-B font. This is especially useful when the ISBN number is not encoded in an EAN-13 bar code. The following example shows how to configure the imager to read the ISBN strings on books in Japan. After you have followed the steps below, you will be able to scan the following ISBN number or the additional data below it, depending on the line of text at which the imager is aimed.

ISBN4-594-03019-X

C0097 ¥838E

1. Scan the [OCR-B On](#) bar code on [page 9-2](#).
2. Program the user-defined variable “g” to comprise the ten digits plus the dash:

0123456789-

3. In Japan, it is common for two fields to follow the ISBN number, the three digit price field, and the four digit price field. The first field typically starts with a “C” (uppercase c), followed by four digits. The second field typically starts with a “P” or a yen symbol, followed by three or four digits, followed by an “E.” Program the user-defined variable “h” to comprise the “P” and the yen symbol (represented by a backslash).

P\

4. Scan the symbol below to set up three templates to handle the ISBN number, the three digit price field, and the four digit price field.



5. Finally, set up the ISBN check digit, which is a special position-weighted modulo 11 checksum. The imager automatically invokes the ISBN checksum for template rows that are:
 - 1.) at least fourteen characters long,
 - 2.) whose first four characters are the letters "ISBN,"
 - 3.) whose last character is a check character, and
 - 4.) when the modulo 11 check character "0123456789X" is programmed.

Please note that all these commands can be combined into a single serial programming command:

```
OCRENA2,TMP"ISBNgggggggggggctCdddd hdddEtCdddd  
hdddE",GPG"0123456789-",GPH"PV",CHK"0123456789X".
```

These commands can be encoded into the following Aztec Code symbol:



OCR Template Codes

Note: Reading more than three rows of OCR is not recommended. Contact the factory if you have an application that requires reading four or more rows of OCR.



Enter OCR Template †



Enter User-Defined
Variable "g" †



Enter User-Defined
Variable "h" †

† One or more two-digit numbers and **Save** are required after reading this programming symbol. Refer to the [Programming Chart](#) on the inside the back cover of this manual.

Exit Selections



Save OCR Template



Discard OCR Template

Keyboard Function Relationships

The following Keyboard Function Code, Hex/ASCII Value, and Full ASCII "CTRL" + "CTRL"+ relationships apply to all terminals that can be used with the imager. Refer to [page 2-14](#) enable Control + ASCII mode.

Function Code	HEX/ASCII Value	Full ASCII "CTRL" +
NUL	00	2
SOH	01	A
STX	02	B
ETX	03	C
EOT	04	D
ENQ	05	E
ACK	06	F
BEL	07	G
BS	08	H
HT	09	I
LF	0A	J
VT	0B	K
FF	0C	L
CR	0D	M
SO	0E	N
SI	0F	O
DLE	10	P
DC1	11	Q
DC2	12	R
DC3	13	S
DC4	14	T
NAK	15	U
SYN	16	V
ETB	17	W
CAN	18	X
EM	19	Y
SUB	1A	Z
ESC	1B	[
FS	1C	\
GS	1D]
RS	1E	6
US	1F	-

The last five characters in the Full ASCII “CTRL”+ column ([\]6 -), apply to US only. The following chart indicates the equivalents of these five characters for different countries.

Country	Codes				
United States	[\]	6	-
Belgium	[<]	6	-
Scandinavia	8	<	9	6	-
France	^	8	\$	6	=
Germany		Ã	+	6	-
Italy		\	+	6	-
Switzerland		<	..	6	-
United Kingdom	[¢]	6	-
Denmark	8	\	9	6	-
Norway	8	\	9	6	-
Spain	[\]	6	-

Supported Interface Keys

ASCII	HEX	IBM AT/XT and PS/2 Compatibles, WYSE PC/AT Supported Keys	IBM XTs and Compatibles Supported Keys	IBM, DDC, Memorex Telex, Harris* Supported Keys
NUL	00	Reserved	Reserved	Reserved
SOH	01	Enter (KP)	CR/Enter	Enter
STX	02	Cap Lock	Caps Lock	F11
ETX	03	ALT make	Reserved	F12
EOT	04	ALT break	Reserved	F13
ENQ	05	CTRL make	Reserved	F14
ACK	06	CTRL break	Reserved	F15
BEL	07	CR/Enter	CR/Enter	New Line
BS	08	Reserved	Reserved	F16
HT	09	Tab	Tab	F17
LF	0A	Reserved	Reserved	F18
VT	0B	Tab	Tab	Tab/Field Forward
FF	0C	Delete	Delete	Delete
CR	0D	CR/Enter	CR/Enter	Field Exit/New Line
SO	0E	Insert	Insert	Insert
SI	0F	Escape	Escape	F19
DLE	10	F11	Reserved	Error Reset
DC1	11	Home	Home	Home
DC2	12	Print	Print	F20
DC3	13	Back Space	Back Space	Back Space
DC4	14	Back Tab	Back Tab	Backfield/Back Tab
NAK	15	F12	Reserved	F21
SYN	16	F1	F1	F1
ETB	17	F2	F2	F2
CAN	18	F3	F3	F3
EM	19	F4	F4	F4
SUB	1A	F5	F5	F5
ESC	1B	F6	F6	F6
FS	1C	F7	F7	F7
GS	1D	F8	F8	F8
RS	1E	F9	F9	F9
US	1F	F10	F10	F10

* IBM 3191/92, 3471/72, 3196/97, 3476/77, Telex (all models)

Supported Interface Keys

ASCII	HEX	IBM, Memorex Telex (102)* Supported Keys	Memorex Telex (88)** Supported Keys
NUL	00	Reserved	Reserved
SOH	01	Enter	Enter
STX	02	F11	PF10
ETX	03	F12	PF11
EOT	04	F13	PF12
ENQ	05	F14	Reserved
ACK	06	F15	Reserved
BEL	07	New Line	New Line
BS	08	F16	Field Forward
HT	09	F17	Field Forward
LF	0A	F18	Reserved
VT	0B	Tab/Field Forward	Field Forward
FF	0C	Delete	Delete
CR	0D	Field Exit	New Line
SO	0E	Insert	Insert
SI	0F	Clear	Erase
DLE	10	Error Reset	Error Reset
DC1	11	Home	Reserved
DC2	12	Print	Print
DC3	13	Back Space	Back Space
DC4	14	Back Tab	Back Field
NAK	15	F19	Reserved
SYN	16	F1	PF1
ETB	17	F2	PF2
CAN	18	F3	PF3
EM	19	F4	PF4
SUB	1A	F5	PF5
ESC	1B	F6	PF6
FS	1C	F7	PF7
GS	1D	F8	PF8
RS	1E	F9	PF9
US	1F	F10	Home

* IBM 3196/97, 3476/77, 3191/92, 3471/72, Memorex Telex (all models) with 102 key keyboards

** Memorex Telex with 88 key keyboards

Supported Interface Keys

ASCII	HEX	Esprit 200, 400 ANSI Supported Keys	Esprit 200, 400 ASCII Supported Keys	Esprit 200, 400 PC Supported Keys
NUL	00	Reserved	Reserved	Reserved
SOH	01	New Line	New Line	New Line
STX	02	N/A	N/A	N/A
ETX	03	N/A	N/A	N/A
EOT	04	N/A	N/A	N/A
ENQ	05	N/A	N/A	N/A
ACK	06	N/A	N/A	N/A
BEL	07	New Line	New Line	New Line
BS	08	N/A	N/A	N/A
HT	09	Tab	Tab	Tab
LF	0A	N/A	N/A	N/A
VT	0B	Tab	Tab	Tab
FF	0C	N/A	N/A	Delete
CR	0D	New Line	New Line	New Line
SO	0E	N/A	N/A	Insert
SI	0F	Escape	Escape	Escape
DLE	10	F11	F11	F11
DC1	11	Insert	Insert	Home
DC2	12	F13	F13	Print
DC3	13	Back Space	Back Space	Back Space
DC4	14	Back Tab	Back Tab	Back Tab
NAK	15	F12	F12	F12
SYN	16	F1	F1	F1
ETB	17	F2	F2	F2
CAN	18	F3	F3	F3
EM	19	F4	F4	F4
SUB	1A	F5	F5	F5
ESC	1B	F6	F6	F6
FS	1C	F7	F7	F7
GS	1D	F8	F8	F8
RS	1E	F9	F9	F9
US	1F	F10	F10	F10

Supported Interface Keys

ASCII	HEX	Apple Mac/iMac Supported Keys
NUL	00	Reserved
SOH	01	Enter/Numpad Enter
STX	02	CAPS
ETX	03	ALT make
EOT	04	ALT break
ENQ	05	CNTRL make
ACK	06	CNTRL break
BEL	07	RETURN
BS	08	APPLE make
HT	09	TAB
LF	0A	APPLE break
VT	0B	TAB
FF	0C	Del
CR	0D	RETURN
SO	0E	Ins Help
SI	0F	ESC
DLE	10	F11
DC1	11	Home
DC2	12	Prnt Scrn
DC3	13	BACKSPACE
DC4	14	LSHIFT TAB
NAK	15	F12
SYN	16	F1
ETB	17	F2
CAN	18	F3
EM	19	F4
SUB	1A	F5
ESC	1B	F6
FS	1C	F7
GS	1D	F8
RS	1E	F9
US	1F	F10
DEL	7F	BACKSPACE

To Add a Test Code I.D. Prefix to All Symbologies

This selection allows you to turn on transmission of a Code I.D. before the decoded symbology. (See the Symbology Chart, included in the [Appendix A](#), page A-1) for the single character code that identifies each symbology.) This action first clears all current prefixes, then programs a Code I.D. prefix for all symbologies. This is a temporary setting that will be removed when the unit is power cycled.



Add Code I.D. Prefix to
All Symbologies (Temporary)

Show Decoder Revision

Scan the bar code below to output the decoder revision.



Show Decoder Revision

Show Engine Revision

Scan the bar code below to output the engine revision. It will return the engine type, revision number, and status character [ACK]. For example, an imager with a 5100 engine, version 26 would return:

```
ENGREVType: 1 Revision: 26[ACK]
```



Show Engine Revision

Show Scan Driver Revision

Scan the bar code below to output the scan driver revision. The scan driver controls image capture.



Show Scan Driver Revision

Show Software Revision

Scan the bar code below to output the current software revision, unit serial number, and other product information for both the imager and base.



Show Revision

Show Data Format

Scan the bar code below to show current data format settings.



Data Format Settings

Reset Imager

Scanning this bar code causes the imager to re-link with the base.



Reset Imager

Imager Report

Scan the bar code below to generate a report for the connected imagers. The report indicates the port, work group, imager name, and address. To assign a name to your imager, refer to "[Menu Command Syntax](#)" on page 12-1.



Imager Report

Imager Address

Scan the bar code below to determine the address of the imager you are using.



Imager Address

Base Address

Scan the bar code below to determine the address of the base you are using.



Base Address

Resetting the Standard Product Default Settings: Current Application Work Group

If you aren't sure what programming options are in your imager, or you've changed some options and want the standard product default settings restored, scan the **Standard Product Default Settings: Current Application Group** bar code below.

The [Menu Commands](#) starting on [page 12-5](#) list the factory default settings for each of the commands (indicated by an asterisk (*) on the programming pages).

Note: Scanning this bar code also causes both the imager and the base to perform a reset and become unlinked. The imager must be placed in its base to re-establish the link before any setup codes are entered. Refer to "Imager Modes" on page 3-5 for additional information.



Standard Product Default Settings:
Current Application Group

Resetting the Standard Product Default Settings: All Application Work Groups

The following bar code defaults all of the work groups to the factory settings.



Standard Product Default Settings:
All Application Groups

The [Menu Commands](#) starting on [page 12-5](#) list the standard product default settings for each of the commands (indicated by an asterisk (*) on the programming pages).

Test Menu

When you scan the Test Menu **On** code, then scan a programming code in this manual, the imager displays the content of a programming code. The programming function will still occur, but in addition, the content of that programming code is output to the terminal.

Note: This feature should not be used during normal imager operation.



On

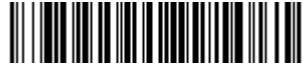

* Off

Visual Xpress

Visual Xpress provides a wide range of PC-based programming functions that can be performed on an imager connected to your PC's COM port. Visual Xpress allows you to download upgrades to the imager's firmware, change programmed parameters, and create and print programming bar codes. Using Visual Xpress, you can even save/open the programming parameters for an imager. This saved file can be e-mailed or, if required, you can create a single bar code that contains all the customized programming parameters and mail or fax that bar code to any location. Users in other locations can scan the bar code to load in the customized programming.

To communicate with an imager, Visual Xpress requires that the PC have at least one available serial communication port, or a serial port emulation using a physical USB port. If you are using the serial port and RS-232 cable, an external power supply is required. When using a USB serial port emulation, only a USB cable is required.

Visual Xpress Operations

The Visual Xpress software performs the following operations:

Scan Data

Scan Data allows you to scan bar codes and display the bar code data in a window. Scan Data lets you send serial commands to the imager and receive imager response that can be seen in the Scan Data window. The data displayed in the Scan Data window can either be saved in a file or printed.

Configure

Configure displays the programming and configuration data of the imager. The imager's programming and configuration data is grouped into different categories. Each category is displayed as a tree item under the "Configure" tree node in the application explorer. When one of these tree nodes is clicked, the right-hand side is loaded with the parameters' form belonging to that particular category. The "Configure" tree option has all the programming and configuration parameters specified for an imager. You can set or modify these parameters as required. You can later write the modified settings to the imager, or save them to a dcf file.

Imaging

Imaging provides all the image-related functions that a 2D Imager can perform. You can capture an image using the current settings, and the image will be displayed in an image window. Images captured from the imager can be saved to files in different image formats. You can modify the image settings and save the image settings to an INI file, which can be loaded later to capture new images. Imaging also lets you preview the images continuously captured by the imager.

Installing Visual Xpress from the Web

1. Access the Hand Held Products web site at www.handheld.com.
2. Click in the **Quick Search** text box and enter **Visual Xpress**.
3. Click on **Search Now**.
4. Click on the entry for **Visual Xpress**.
5. When prompted, select **Save File**, and save the files to the **c:\windows\temp** directory.
6. Once you have finished downloading the file, exit the web site.
7. Using Explorer, go to the **c:\windows\temp** file and unzip the file you saved.
8. Double click on **Setup.exe** and follow the screen prompts to install the Visual Xpress program.
9. If you've selected the defaults during installation, you can click on **Start Menu-Programs-Hand Held Products-Visual Xpress**.

*Quick*View*

Quick*View is a Microsoft® Windows® program that displays decoded symbol messages and captures images (for instance, ID photographs) from the imager. Bar code information and images are displayed in the Quick*View window.

*Installing Quick*View from the Web*

1. Access the Hand Held Products web site at www.handheld.com.
2. Click on **Search** and enter **Quick*View**.
3. Click on **Search**.
4. Click on the entry for Software. Select **Quick*View Software Utility**.
5. When prompted, select **Save**, and save the files to the **c:\windows\temp** directory.
6. Once you have finished downloading the file, exit the web site.
7. Using Explorer, go to the **c:\windows\temp** file.
8. Double click on the **Quickview.exe** file. Follow the screen prompts to install the Quick*View program.
9. To start Quick*View, from the Start Menu click on **Programs, Quick*View, Quick*View**.

*Note: If you wish, you can create a shortcut to the Quick*View executable on your desktop.*

*Temporary Quick*View Configuration*

For a quick download communication configuration, scan the Quick*View bar code and the imager will be temporarily configured for Quick*View settings.

*Note: If you have a unit capable of keyboard wedge mode, scan the bar code below and the unit will communicate in RS-232 mode, allowing it to work with Quick*View. To convert the imager back to keyboard wedge communication, cycle the power.*



Quick*View

The serial programming commands can be used in place of the programming bar codes. Both the serial commands and the programming bar codes will program the imager. For complete descriptions and examples of each serial programming command, refer to the corresponding programming bar code in this manual.

The device must be set to an RS-232 interface (see page 2-2). The following commands can be sent via a PC COM port using terminal emulation software.

Conventions

The following conventions are used for menu and query command descriptions:

parameter A label representing the actual value you should send as part of a command.

[*option*] An optional part of a command.

{Data} Alternatives in a command.

bold Names of menus, menu commands, buttons, dialog boxes, and windows that appear on the screen.

Menu Command Syntax

Menu commands have the following syntax (spaces have been used for clarity only):

Prefix [:Name:] Tag SubTag {Data} [, SubTag {Data}] [: Tag SubTag {Data}] [...]
Storage

Prefix Three ASCII characters: **SYN M CR** (ASCII 22,77,13).

:Name: To send information to the imager (with the base connected to host), use :4820: or :4820i: The default factory setting for a 4820 imager is 4820, and 4820i for a 4820i imager. This setting is changed by using the BT_NAM command, which accepts alphanumeric values. If the name is not known, a wildcard (*) can be used :*:.
:*.:

Note: Since the base stores all work group settings and transfers to them to imager once they are linked, changes are typically done to the base and not to the imager.

Tag A 3 character case-insensitive field that identifies the desired menu command group. For example, all RS-232 configuration settings are identified with a Tag of **232**.

SubTag A 3 character case-insensitive field that identifies the desired menu command within the tag group. For example, the SubTag for the RS-232 baud rate is **BAD**.

Data The new value for a menu setting, identified by the Tag and Sub-Tag.

Storage A single character that specifies the storage table to which the command is applied. An exclamation point (!) performs the command's operation on the device's volatile menu configuration table. A period (.) performs the command's operation on the device's non-volatile menu configuration table. Use the non-volatile table only for semi-permanent changes you want saved through a power cycle.

Query Commands

Several special characters can be used to query the device about its settings.

- ^** What is the default value for the setting(s).
- ?** What is the device's current value for the setting(s).
- *** What is the range of possible values for the setting(s). (The device's response uses a dash (-) to indicate a continuous range of values. A pipe (|) separates items in a list of non-continuous values.)

:Name: Field Usage (Optional)

This command returns the query information from the imager.

Tag Field Usage

When a query is used in place of a Tag field, the query applies to the *entire* set of commands available for the particular storage table indicated by the Storage field of the command. In this case, the SubTag and Data fields should not be used because they are ignored by the device.

SubTag Field Usage

When a query is used in place of a SubTag field, the query applies only to the subset of commands available that match the Tag field. In this case, the Data field should not be used because it is ignored by the device.

Data Field Usage

When a query is used in place of the Data field, the query applies only to the specific command identified by the Tag and SubTag fields.

Concatenation of Multiple Commands

Multiple commands can be issued within one Prefix/Storage sequence. Only the Tag, SubTag, and Data fields must be repeated for each command in the sequence. If additional commands are to be applied to the same Tag, then the new command sequence is separated with a comma (,) and only the SubTag and Data fields of the additional command are issued. If the additional command requires a different Tag field, the command is separated from previous commands by a semicolon (;).

Responses

The device responds to serial commands with one of three responses:

ACK Indicates a good command which has been processed.

ENQ Indicates an invalid Tag or SubTag command.

NAK Indicates the command was good, but the Data field entry was out of the allowable range for this Tag and SubTag combination, e.g., an entry for a minimum message length of 100 when the field will only accept 2 characters.

When responding, the device echoes back the command sequence with the status character inserted directly before each of the punctuation marks (the period, exclamation point, comma, or semicolon) in the command.

Examples of Query Commands

In the following examples, a bracketed notation [] depicts a non-displayable response.

Example #1: What is the range of possible values for Codabar Coding Enable?

Enter: **cbrena*.**

Response: **CBRENA0-1[ACK]**

This response indicates that Codabar Coding Enable (CBRENA) has a range of values from 0 to 1 (off and on).

Example #2: What is the default value for Codabar Coding Enable?

Enter: **cbrena^.**

Response: **CBRENA1[ACK]**

This response indicates that the default setting for Codabar Coding Enable (CBRENA) is 1, or on.

Example #3: What is the device's current setting for Codabar Coding Enable?

Enter: **cbrena?.**

Response: **CBRENA1[ACK]**

This response indicates that the device's Codabar Coding Enable (CBRENA) is set to 1, or on.

Example #4: What are the device's settings for all Codabar selections?

Enter: **cbr?.**

Response: **CBRENA1[ACK],**
 SSX0[ACK],
 CK20[ACK],
 CCT1[ACK],
 MIN2[ACK],
 MAX60[ACK],
 DFT[ACK].

This response indicates that the device's Codabar Coding Enable (CBRENA) is set to 1, or on;
the Start/Stop Character (SSX) is set to 0, or Don't Transmit;
the Check Character (CK2) is set to 0, or Not Required;
concatenation (CCT) is set to 1, or Enabled;
the Minimum Message Length (MIN) is set to 2 characters;
the Maximum Message Length (MAX) is set to 60 characters;
and the Default setting (DFT) has no value.

Trigger Commands

You can activate and deactivate the imager with serial trigger commands. First, the imager must be put in Manual/Serial Trigger Mode either by scanning the Manual/Serial Trigger Mode bar code (page 4-4), or by sending the Manual/Serial Menu Command (page 12-9). Once the imager is in serial trigger mode, the trigger is activated and deactivated by sending the following commands:

Activate: **SYN T CR**

Deactivate: **SYN U CR**

The imager scans until a bar code has been read, until the deactivate command is sent, or until the serial time-out has been reached (see "Read Time-Out (Serial Trigger Mode)" on page 4-4 for a description, and the serial command on page 12-9).

Menu Commands

Selection	Setting <i>* Indicates default</i>	Serial Command <i># Indicates a numeric entry</i>	Page
<i>Programming the Interface</i>			
Terminal ID	*003	TERMID###	2-7
Program Keyboard Country	*U.S.A.	KBDCTY0	2-10
	Belgium	KBDCTY1	2-10
	Brazil	KBDCTY16	2-10
	Canada (French)	KBDCTY18	2-10
	Czech Republic	KBDCTY15	2-10
	Denmark	KBDCTY8	2-10
	Finland (Sweden)	KBDCTY2	2-10
	France	KBDCTY3	2-10
	Germany/Austria	KBDCTY4	2-10
	Greece	KBDCTY17	2-10
	Hungary	KBDCTY19	2-10
	Israel (Hebrew)	KBDCTY12	2-10
	Italy	KBDCTY5	2-11
	Latin America	KBDCTY14	2-11
	Netherlands (Dutch)	KBDCTY11	2-11
	Norway	KBDCTY9	2-11
	Poland	KBDCTY20	2-11
	Portugal	KBDCTY13	2-11
	Romania	KBDCTY25	2-11
	Russia	KBDCTY26	2-11
	SCS	KBDCTY21	2-11
	Slovakia	KBDCTY22	2-11
Spain	KBDCTY10	2-11	
Sweden	KBDCTY23	2-11	
Switzerland (German)	KBDCTY6	2-11	
Turkey F	KBDCTY27	2-12	
Turkey Q	KBDCTY24	2-12	
U.K.	KBDCTY7	2-12	

Selection	Setting <i>* Indicates default</i>	Serial Command <i># Indicates a numeric entry</i>	Page
Keyboard Style	*Regular	KBDSTY0	2-12
	Caps Lock	KBDSTY1	2-12
	Shift Lock	KBDSTY2	2-13
	Automatic Caps Lock	KBDSTY6	2-13
	Emulate External Keyboard	KBDSTY5	2-13
Keyboard Modifiers	*Control + ASCII Off	KBDCAS0	2-14
	Control + ASCII On	KBDCAS1	2-14
	*Turbo Mode Off	KBDTMD0	2-14
	Turbo Mode On	KBDTMD1	2-14
	*Numeric Keypad Off	KBDNPS0	2-14
	Numeric Keypad On	KBDNPS1	2-14
	*Auto Direct Conn. Off	KBDADC0	2-14
	Auto Direct Conn. On	KBDADC1	2-14
Baud Rate	300 BPS	232BAD0	2-15
	600 BPS	232BAD1	2-15
	1200 BPS	232BAD2	2-15
	2400 BPS	232BAD3	2-15
	4800 BPS	232BAD4	2-15
	9600 BPS	232BAD5	2-15
	19200 BPS	232BAD6	2-15
	38400 BPS	232BAD7	2-15
	57600 BPS	232BAD8	2-15
	*115200 BPS	232BAD9	2-15
Word Length: Data Bits, Stop Bits, and Parity	7 Data, 1 Stop, Parity Even	232WRD3	2-16
	7 Data, 1 Stop, Parity None	232WRD0	2-16
	7 Data, 1 Stop, Parity Odd	232WRD6	2-16
	7 Data, 2 Stop, Parity Even	232WRD4	2-16
	7 Data, 2 Stop, Parity None	232WRD1	2-16
	7 Data, 2 Stop, Parity Odd	232WRD7	2-16
	8 Data, 1 Stop, Parity Even	232WRD5	2-16
	*8 Data, 1 Stop, Parity None	232WRD2	2-16
	8 Data, 1 Stop, Parity Odd	232WRD8	2-16

Selection	Setting <i>* Indicates default</i>	Serial Command <i># Indicates a numeric entry</i>	Page
RS-232 Receiver Time-out	Range 0 - 300 seconds	232LPT###	2-17
RS-232 Handshaking	*RTS/CTS Off	232CTS0	2-17
	RTS/CTS On	232CTS2	2-17
	*XON/XOFF Off	232XON0	2-17
	XON/XOFF On	232XON1	2-17
	*ACK/NAK Off	232ACK0	2-17
	ACK/NAK On	232ACK1	2-17
Wand Emulation Connection	Same Code Format	TERMID64	2-21
	Code 39 Format	TERMID61	2-21
Data Block Size	20	WNDBLK0	2-21
	*40	WNDBLK1	2-21
	60	WNDBLK2	2-21
	80	WNDBLK3	2-21
Delay Between Blocks	5ms	WNDLDLY0	2-22
	*50ms	WNDLDLY1	2-22
	150ms	WNDLDLY2	2-22
	500ms	WNDLDLY3	2-22
Overall Checksum	On	WNDCHK1	2-22
	*Off	WNDCHK0	2-22
Wand Emulation Transmission Rate	10	WNDSPD0	2-23
	*25	WNDSPD1	2-23
	40	WNDSPD2	2-23
	80	WNDSPD3	2-23
	120	WNDSPD4	2-23
	150	WNDSPD5	2-23
	200	WNDSPD6	2-23
Wand Emulation Polarity	*Black High	WNDPOL0	2-23
	White High	WNDPOL1	2-23
Wand Emulation Idle	Idle Low	WNDIDL0	2-24
	*Idle High	WNDIDL1	2-24

Selection	Setting <i>* Indicates default</i>	Serial Command <i># Indicates a numeric entry</i>	Page
<i>Basic System Operation</i>			
Base Charge Mode	*Automatic	BASCHG1	3-3
	Full Charge Rate	BASCHG2	3-3
	Low Charge Rate	BASCHG3	3-3
	Battery Charge Off	BASCHG4	3-3
Imager Modes - Single	Unlink Imager	BT_RMV	3-5
	*Locked Link Mode	BASCON0,DNG 1	3-6
	Open Link Mode	BASCON1,DNG 1	3-6
	Override Locked Imager	BT_RPL1	3-6
Multiple Imager Operation	Multiple Imager Operation	BASCON2,DNG 3	3-7
Imager Name	Imager Name	BT_NAM	3-9
Imager Report	Imager Report	RPTSCN	3-9
Application Work Group Selections	*Group 0	GRPSEL0	3-10
	Group 1	GRPSEL1	3-10
	Group 2	GRPSEL2	3-10
	Group 3	GRPSEL3	3-10
	Group 4	GRPSEL4	3-10
	Group 5	GRPSEL5	3-10
	Group 6	GRPSEL6	3-10
Standard Product Defaults: Current Application Work Group	Default - Current Work Group	DEFAULT	3-11
Standard Product Defaults: All Application Work Groups	Default - All Work Groups	PAPDFT	3-11
Non-Base Bluetooth Connection	Non-Base BT Connection	BT_DNG5	3-12
Bluetooth PIN Code	Bluetooth PIN	BT_PIN	3-12
Out-of-Range Alarm	Base Alarm Duration (Range 1 - 3000 sec (*0))	BASORD	3-13
	Imager Alarm Duration (Range 1 - 3000 sec (*0))	BT_ORD	3-13

Selection	Setting <i>* Indicates default</i>	Serial Command <i># Indicates a numeric entry</i>	Page
Alarm Sound Type	Base Alarm Type	BASORW	3-13
	Imager Alarm Type	BT_ORW	3-13
Data Accumulation Mode	On	BATENA1	3-14
	*Off	BATENA0	3-14
<i>Output Selections</i>			
Beeper - Good Read	Off	BEPBEP0	4-1
	*On	BEPBEP1	4-1
Beeper Volume - Good Read	Off	BEPLVL0	4-1
	Low	BEPLVL1	4-1
	*Medium	BEPLVL2	4-1
Beeper Pitch - Good Read (Frequency)	Low (1600) (min 400Hz)	BEPFQ11600	4-2
	*Medium (3250)	BEPFQ13250	4-2
	High (4200) (max 9000Hz)	BEPFQ14200	4-2
Beeper Duration - Good Read	*Normal Beep	BEPBIP0	4-2
	Short Beep	BEPBIP1	4-2
LED - Good Read	Off	BEPLD0	4-2
	*On	BEPLD1	4-2
Number of Beeps - Good Read	*1	BEPRPT1	4-3
	Range 1 - 9	BEPRPT#	4-3
Good Read Delay	*No Delay	DLYGRD0	4-3
	Short Delay (500 ms)	DLYGRD500	4-3
	Medium Delay (1000 ms)	DLYGRD1000	4-3
	Long Delay (1500 ms)	DLYGRD1500	4-3
User-Specified Good Read Delay	Range 0 - 30,000 ms	DLYGRD#####	4-3
Trigger Mode	*Manual/Serial Trigger	TRGMOD0	4-4
	Read Time-Out (0 - 300,000 ms) *300,000	TRGSTO####	4-4
	Imager Power Time-Out Timer (0-7200 seconds) *3600	BT_LPT0	4-5
		BT_LPT200	4-5
		BT_LPT400	4-5
		BT_LPT900	4-5
		BT_LPT3600	4-5
BT_LPT7200	4-5		

Selection	Setting <i>* Indicates default</i>	Serial Command <i># Indicates a numeric entry</i>	Page
Scan Stand	Scan Stand Mode	TRGMOD4	4-6
	Scan Stand Symbol	FNC3	4-6
Presentation	Presentation Mode	TRGMOD3	4-6
Presentation LED Timer	LEDs Off	TRGPCK0	4-7
	*LEDs On	TRGPCK1	4-7
Presentation Sensitivity	Range 0-20 (*1)	TRGPMS##	4-7
Hands Free Time-Out	Range 0 - 300,000 ms	TRGPTO#####	4-7
Reread Delay	Short (500 ms)	DLYRRD500	4-8
	*Medium (750 ms)	DLYRR750	4-8
	Long (1000 ms)	DLYRRD1000	4-8
	Extra Long (2000 ms)	DLYRRD2000	4-8
User-Specified Reread Delay	Range 0 - 30,000 ms	DLYRRD#####	4-8
LED Power Level	Off	PWRLDC0	4-9
	Low (50%)	PWRLDC50	4-9
	*High (100%)	PWRLDC100	4-9
Illumination Lights	*Lights On	SCNLED1	4-9
	Lights Off	SCNLED0	4-9
Aimer Delay	200 milliseconds	SCNDLY200	4-10
	400 milliseconds	SCNDLY400	4-10
	*Off (no delay)	SCNDLY0	4-10
User-Specified Aimer Delay	Range 0 - 4,000 ms	SCNDLY####	4-10
Aimer Mode	Off	SCNAIM0	4-10
	*Interlaced	SCNAIM2	4-10
Centering Window	Centering On	DECWIN1	4-12
	*Centering Off	DECWIN0	4-12
	Left of Centering Window (*40%)	DECLFT	4-12
	Right of Centering Window (*60%)	DECRGT	4-12
	Top of Centering Window (*40%)	DECTOP	4-12
	Bottom of Centering Window (*60%)	DECBOT	4-12

Selection	Setting <i>* Indicates default</i>	Serial Command <i># Indicates a numeric entry</i>	Page
Decode Search Mode	Full Omnidirectional (Default for 2D imagers)	DECMOD0	4-13
	Quick Omnidirectional	DECMOD1	4-13
Output Sequence Editor	Enter Sequence	SEQBLK	4-16
	Default Sequence	SEQDFT	4-16
Require Output Sequence	Required	SEQ_EN2	4-17
	On/Not Required	SEQ_EN1	4-17
	*Off	SEQ_EN0	4-17
Multiple Symbols	On	SHOTGN1	4-17
	*Off	SHOTGN0	4-17
No Read	On	SHWNRD1	4-17
	*Off	SHWNRD0	4-17
Print Weight	Set Print Weight (1-7)	PRTWGT	4-18
	*Default (4)	PRTWGT4	4-18
Video Reverse	On	VIDREV1	4-18
	*Off	VIDREV0	4-18
Working Orientation	*Upright	ROTATN0	4-19
	Rotate Code Clockwise 90°	ROTATN1	4-19
	Upside Down	ROTATN2	4-19
	Rotate Code Counterclockwise 90°	ROTATN3	4-19
<i>Prefix/Suffix Selections</i>			
Add CR Suffix to All Symbolologies		VSUFCCR	5-3
Prefix	Add Prefix	PREBK2##	5-4
	Clear One Prefix	PRECL2	5-4
	Clear All Prefixes	PRECA2	5-4
Suffix	Add Suffix	SUFBK2##	5-4
	Clear One Suffix	SUFCL2	5-4
	Clear All Suffixes	SUFCA2	5-4
Function Code Transmit	*Enable	RMVFNC0	5-4
	Disable	RMVFNC1	5-4
Intercharacter Delay	Range 0 - 495 ms	DLYCHR##	5-5

Selection	Setting <i>* Indicates default</i>	Serial Command <i># Indicates a numeric entry</i>	Page
User Specified Intercharacter Delay	Delay Length (0 - 495 ms)	DLYCRX##	5-6
	Character to Trigger Delay	DLY_XX###	5-6
Interfunction Delay	Range 0 - 495 ms	DLYFNC##	5-6
Intermessage Delay	Range 0 - 495 ms	DLYMSG##	5-7
<i>Data Formatter Selections</i>			
Data Format Editor	*Default Data Format (None)	DFMDF3	6-4
	Enter Data Format	DFMBK3##	6-4
	Clear One Data Format	DFMCL3	6-4
	Clear All Data Formats	DFMCA3	6-4
Data Formatter	Off	DFM_EN0	6-5
	*On, but Not Required	DFM_EN1	6-5
	On, Required	DFM_EN2	6-5
Alternate Data Formats	1	VSAF_1	6-5
	2	VSAF_2	6-5
	3	VSAF_3	6-5
<i>Symbologies</i>			
All Symbologies	All Symbologies Off	ALLENA0	7-2
	All Symbologies On	ALLENA1	7-2
Codabar	Default All Codabar Settings	CBRDFT	7-3
Codabar	Off	CBRENA0	7-3
	*On	CBRENA1	7-3
Codabar Start/Stop Char.	*Don't Transmit	CBRSSX0	7-3
	Transmit	CBRSSX1	7-3
Codabar Check Char.	*No Check Char.	CBRCK20	7-4
	Validate, But Don't Transmit	CBRCK21	7-4
	Validate, and Transmit	CBRCK22	7-4
Codabar Concatenation	*Off	CBRCCT0	7-4
	On	CBRCCT1	7-4
	Require	CBRCCT2	7-4
Codabar Message Length	Minimum (2 - 60) *4	CBRMIN##	7-5
	Maximum (2 - 60) *60	CBRMAX##	7-5

Selection	Setting <i>* Indicates default</i>	Serial Command <i># Indicates a numeric entry</i>	Page
Code 39	Default All Code 39 Settings	C39DFT	7-5
Code 39	Off	C39ENA0	7-5
	*On	C39ENA1	7-5
Code 39 Start/Stop Char.	*Don't Transmit	C39SSX0	7-6
	Transmit	C39SSX1	7-6
Code 39 Check Char.	*No Check Char.	C39CK20	7-6
	Validate, But Don't Transmit	C39CK21	7-6
	Validate, and Transmit	C39CK22	7-6
Code 39 Message Length	Minimum (0 - 48) *0	C39MIN##	7-7
	Maximum (0 - 48) *48	C39MAX##	7-7
Code 39 Append	*Off	C39APP0	7-7
	On	C39APP1	7-7
Code 32 Pharmaceutical (PARAF)	*Off	C39B320	7-8
	On	C39B321	7-8
Code 39 Full ASCII	*Off	C39ASC0	7-9
	On	C39ASC1	7-9
	Code 39 Code Page	C39DCP	7-9
Interleaved 2 of 5	Default All Interleaved 2 of 5 Settings	I25DFT	7-9
Interleaved 2 of 5	Off	I25ENA0	7-9
	*On	I25ENA1	7-9
Interleaved 2 of 5 Check Digit	*No Check Char.	I25CK20	7-10
	Validate, But Don't Transmit	I25CK21	7-10
	Validate, and Transmit	I25CK22	7-10
Interleaved 2 of 5 Message Length	Minimum (2 - 80) *4	I25MIN##	7-10
	Maximum (2 - 80) *80	I25MAX##	7-10
Code 93	Default All Code 93 Settings	C93DFT	7-11
Code 93	Off	C93ENA0	7-11
	*On	C93ENA1	7-12

Selection	Setting <i>* Indicates default</i>	Serial Command <i># Indicates a numeric entry</i>	Page
Code 93 Message Length	Minimum (0 - 80) *0	C93MIN##	7-11
	Maximum (0 - 80) *80	C93MAX##	7-11
	Code 93 Code Page	C93DCP	7-12
Straight 2 of 5 Industrial	Default All Straight 2 of 5 Industrial Settings	R25DFT	7-12
Straight 2 of 5 Industrial	*Off	R25ENA0	7-12
	On	R25ENA1	7-12
Straight 2 of 5 Industrial Message Length	Minimum (1 - 48) *4	R25MIN##	7-13
	Maximum (1 - 48) *48	R25MAX##	7-13
Straight 2 of 5 IATA	Default All Straight 2 of 5 IATA Settings	A25DFT	7-13
Straight 2 of 5 IATA	*Off	A25ENA0	7-13
	On	A25ENA1	7-13
Straight 2 of 5 IATA Message Length	Minimum (1 - 48) *4	A25MIN##	7-14
	Maximum (1 - 48) *48	A25MAX##	7-14
Matrix 2 of 5	Default All Matrix 2 of 5 Settings	X25DFT	7-14
Matrix 2 of 5	*Off	X25ENA0	7-14
	On	X25ENA1	7-14
Matrix 2 of 5 Message Length	Minimum (1 - 80) *4	X25MIN##	7-15
	Maximum (1 - 80) *80	X25MAX##	7-15
Code 11	Default All Code 11 Settings	C11DFT	7-15
Code 11	*Off	C11ENA0	7-15
	On	C11ENA1	7-15
Code 11 Check Digits Required	1 Check Digit	C11CK20	7-16
	*2 Check Digits	C11CK21	7-16
Code 11 Message Length	Minimum (1 - 80) *4	C11MIN##	7-16
	Maximum (1 - 80) *80	C11MAX##	7-16
Code 128	Default All Code 128 Settings	128DFT	7-16
Code 128	Off	128ENA0	7-17
	*On	128ENA1	7-17
ISBT Concatenation	*Off	ISBENA0	7-17
	On	ISBENA1	7-17

Selection	Setting <i>* Indicates default</i>	Serial Command <i># Indicates a numeric entry</i>	Page
Code 128 Message Length	Minimum (0 - 80) *0	128MIN##	7-17
	Maximum (0 - 80) *80	128MAX##	7-17
Code 128 Code Page	Code 128 Code Page (*2)	128DCP##	7-18
Telepen	Default All Telepen Settings	TELDFT	7-18
Telepen	*Off	TELENA0	7-18
	On	TELENA1	7-18
Telepen Output	*AIM Telepen Output	TELOLD0	7-19
	Original Telepen Output	TELOLD1	7-19
Telepen Message Length	Minimum (1 - 60) *1	TELMIN##	7-19
	Maximum (1 - 60) *60	TELMAX##	7-19
UPC-A	Default All UPC-A Settings	UPADFT	7-19
UPC-A	Off	UPAENA0	7-20
	*On	UPAENA1	7-20
UPC-A Check Digit	Off	UPACKX0	7-20
	*On	UPACKX1	7-20
UPC-A Number System	Off	UPANSX0	7-20
	*On	UPANSX1	7-20
UPC-A 2 Digit Addenda	*Off	UPAAD20	7-21
	On	UPAAD21	7-21
UPC-A 5 Digit Addenda	*Off	UPAAD50	7-21
	On	UPAAD51	7-21
UPC-A Addenda Required	*Not Required	UPAARQ0	7-21
	Required	UPAARQ1	7-21
UPC-A Addenda Separator	Off	UPAADS0	7-21
	*On	UPAADS1	7-21
UPC-A/EAN-13 with Extended Coupon Code	*On	CPNENA1	7-22
	Off	CPNENA0	7-22
UPC-E0	Default All UPC-E Settings	UPEDFT	7-22
UPC-E0	Off	UPEEN00	7-22
	*On	UPEEN01	7-22

Selection	Setting <i>* Indicates default</i>	Serial Command <i># Indicates a numeric entry</i>	Page
UPC-E0 Expand	*Off	UPEEXP0	7-23
	On	UPEEXP1	7-23
UPC-E0 Addenda Required	Required	UPEARQ1	7-23
	*Not Required	UPEARQ0	7-23
UPC-E0 Addenda Separator	*On	UPEADS1	7-23
	Off	UPEADS0	7-23
UPC-E0 Check Digit	Off	UPECKX0	7-24
	*On	UPECKX1	7-24
UPC-E0 Number System	Off	UPENSX0	7-24
	*On	UPENSX1	7-24
UPC-E0 Addenda	2 Digit Addenda On	UPEAD21	7-24
	*2 Digit Addenda Off	UPEAD20	7-24
	5 Digit Addenda On	UPEAD51	7-24
	*5 Digit Addenda Off	UPEAD50	7-24
UPC-E1	*Off	UPEEN10	7-25
	On	UPEEN11	7-25
EAN/JAN-13	Default All EAN/ JAN Settings	E13DFT	7-25
EAN/JAN-13	Off	E13ENA0	7-25
	*On	E13ENA1	7-25
EAN/JAN-13 Check Digit	Off	E13CKX0	7-26
	*On	E13CKX1	7-25
EAN/JAN-13 2 Digit Addenda	2 Digit Addenda On	E13AD21	7-26
	*2 Digit Addenda Off	E13AD20	7-26
	5 Digit Addenda On	E13AD51	7-26
	*5 Digit Addenda Off	E13AD50	7-26
EAN/JAN-13 Addenda Required	*Not Required	E13ARQ0	7-26
	Required	E13ARQ1	7-26
EAN/JAN-13 Addenda Separator	Off	E13ADS0	7-27
	*On	E13ADS1	7-27
ISBN Translate	*Off	E13ISB0	7-27
	On	E13ISB1	7-27
EAN/JAN-8	Default All EAN/ JAN 8 Settings	EA8DFT	7-27

Selection	Setting <i>* Indicates default</i>	Serial Command <i># Indicates a numeric entry</i>	Page
EAN/JAN-8	Off	EA8ENA0	7-28
	*On	EA8ENA1	7-28
EAN/JAN-8 Check Digit	Off	EA8CKX0	7-28
	*On	EA8CKX1	7-28
EAN/JAN-8 Addenda	*2 Digit Addenda Off	EA8AD20	7-28
	2 Digit Addenda On	EA8AD21	7-28
	*5 Digit Addenda Off	EA8AD50	7-28
	5 Digit Addenda On	EA8AD51	7-28
EAN/JAN-8 Addenda Required	*Not Required	EA8ARQ0	7-29
	Required	EA8ARQ1	7-29
EAN/JAN-8 Addenda Separator	Off	EA8ADS0	7-29
	*On	EA8ADS1	7-29
MSI	Default All MSI Settings	MSIDFT	7-29
MSI	*Off	MSIENA0	7-29
	On	MSIENA1	7-29
MSI Check Character	*Validate Type 10, but Don't Transmit	MSICK0	7-30
	Validate Type 10 and Transmit	MSICK1	7-30
MSI Message Length	Minimum (4 - 48) *4	MSIMIN##	7-30
	Maximum (4 - 48) *48	MSIMAX##	7-30
Plessey Code	Default All Plessey Settings	PLSDFT	7-30
Plessey Code	*Off	PLSENA0	7-31
	On	PLSENA1	7-31
Plessey Message Length	Minimum (4 - 48) *4	PLSMIN##	7-31
	Maximum (4 - 48) *48	PLSMAX##	7-31
RSS-14	Default All RSS-14 Settings	RSSDFT	7-31
RSS-14	Off	RSSENA0	7-31
	*On	RSSENA1	7-31
RSS Limited	Default All RSS-14 Limited Settings	RSLDFT	7-32
RSS Limited	Off	RSLENA0	7-32
	*On	RSLENA1	7-32

Selection	Setting <i>* Indicates default</i>	Serial Command <i># Indicates a numeric entry</i>	Page
RSS Expanded	Default All RSS-14 Expanded Settings	RSEDFT	7-32
RSS Expanded	Off	RSEENA0	7-32
	*On	RSEENA1	7-32
RSS Expanded Msg. Length	Minimum (4 - 74) *4	RSEMIN##	7-33
	Maximum (4 - 74) *74	RSEMAX##	7-33
PosiCode	Default All PosiCode Settings	POSDFT	7-35
PosiCode	Off	POSENA0	7-33
	*On	POSENA1	7-33
	A and B On	POSLIM0	7-34
	A and B and Limited A On	POSLIM1	7-34
	*A and B and Limited B On	POSLIM2	7-34
PosiCode Msg. Length	Minimum (2 - 80) *4	POSMIN##	7-34
	Maximum (2 - 80) *48	POSMAX##	7-34
Trioptic Code	*Off	TRIENA0	7-34
	On	TRIENA1	7-34
Codablock F	Default All Codablock F Settings	CBFDFT	7-34
Codablock F	*Off	CBFENA0	7-35
	On	CBFENA1	7-35
Codablock F Msg. Length	Minimum (1 - 2048) *1	CBFMIN####	7-35
	Maximum (1 - 2048) *2048	CBFMAX####	7-35
Code 16K	Default All Code 16K Settings	16KDFT	7-35
Code 16K	*Off	16KENA0	7-36
	On	16KENA1	7-36
Code 16K Msg. Length	Minimum (0 - 160) *1	16KMIN####	7-36
	Maximum (0 - 160) *160	16KMAX####	7-36
Code 49	Default All Code 49 Settings	C49DFT	7-36
Code 49	Off	C49ENA0	7-36
	*On	C49ENA1	7-36
Code 49 Msg. Length	Minimum (1 - 81) *1	C49MIN##	7-37
	Maximum (1 - 81) *81	C49MAX##	7-37
PDF417	Default All PDF417 Settings	PDFDFT	7-37

Selection	Setting <i>* Indicates default</i>	Serial Command <i># Indicates a numeric entry</i>	Page
PDF417	*On	PDFENA1	7-37
	Off	PDFENA0	7-37
PDF417 Msg. Length	Minimum (1-2750) *1	PDFMIN	7-38
	Maximum (1-2750) *2750	PDFMAX	7-38
MicroPDF417	Default All Micro PDF417 Settings	MPDDFT	7-38
MicroPDF417	On	MPDENA1	7-38
	*Off	MPDENA0	7-38
MicroPDF417 Msg. Length	Minimum (1-366) *1	MPDMIN	7-39
	Maximum (1-366) *366	MPDMAX	7-39
EAN•JCC Composite Codes	On	COMENA1	7-39
	*Off	COMENA0	7-39
UPC/EAN Version	On	COMUPC1	7-39
	*Off	COMUPC0	7-39
EAN•JCC Composite Codes Msg. Length	Minimum (1-2435) *1	COMMINS	7-40
	Maximum (1-2435) *2435	COMMAX	7-40
EAN•JCC Emulation	RSS Emulation	EANEMU2	7-40
	EAN•JCC-128 Emulation	EANEMU1	7-40
	*EAN•JCC Emulation Off	EANEMU0	7-40
4-CB (4-State Customer Bar Code)	On	4CBENA1	7-41
	*Off	4CBENA0	7-41
ID-tag (UPU 4-State)	On	TAGENA1	7-41
	*Off	TAGENA0	7-41
TCIF Linked Code 39 (TLC39)	On	T39ENA1	7-41
	*Off	T39ENA0	7-41
Postnet	On	NETENA1	7-42
	*Off	NETENA0	7-42
Postnet Check Digit	Transmit	NETCKX1	7-42
	*Don't Transmit	NETCKX0	7-42
Planet Code	On	PLNENA1	7-42
	*Off	PLNENA0	7-42
Planet Code Check Digit	Transmit	PLNCKX1	7-42
	*Don't Transmit	PLNCKX0	7-42

Selection	Setting <i>* Indicates default</i>	Serial Command <i># Indicates a numeric entry</i>	Page
British Post	On	BPOENA1	7-43
	*Off	BPOENA0	7-43
Canadian Post	On	CANENA1	7-42
	*Off	CANENA0	7-42
Kix (Netherlands) Post	On	KIXENA1	7-44
	*Off	KIXENA0	7-43
Australian Post	On	AUSENA1	7-43
	*Off	AUSENA0	7-44
Australian Post Interpretation	*Bar Output	AUSINT0	7-44
	Numeric N Table	AUSINT1	7-44
	Alphanumeric C Table	AUSINT2	7-44
Japanese Post	On	JAPENA1	7-43
	*Off	JAPENA0	7-43
China Post	Default All China Post Settings	CPCDFT	7-45
China Post	*Off	CPCENA0	7-45
	On	CPCENA1	7-45
China Post Msg. Length	Minimum (2 - 80) *4	CPCMIN##	7-45
	Maximum (2 - 80) *80	CPCMAX##	7-45
Korea Post	Default All Korea Post Settings	KPCDFT	7-46
Korea Post	*Off	KPCENA0	7-46
	On	KPCENA1	7-46
Korea Post Msg. Length	Minimum (2 - 80) *4	KPCMIN##	7-46
	Maximum (2 - 80) *48	KPCMAX##	7-46
QR Code	Default All QR Code Settings	QRCDFT	7-47
QR Code	*On	QRCENA1	7-47
	Off	QRCENA0	7-47
QR Code Msg. Length	Minimum (1-3500) *1	QRCMIN	7-47
	Maximum (1-3500) *3500	QRCMAX	7-47
Data Matrix	Default All Data Matrix Settings	IDMDFT	7-48
Data Matrix	*On	IDMENA1	7-48
	Off	IDMENA0	7-48
Data Matrix Msg. Length	Minimum (1-1500) *1	IDMMIN	7-48
	Maximum (1-1500) *1500	IDMMAX	7-48

Selection	Setting <i>* Indicates default</i>	Serial Command <i># Indicates a numeric entry</i>	Page
MaxiCode	Default All MaxiCode Settings	MAXDFT	7-49
MaxiCode	*On	MAXENA1	7-49
	Off	MAXENA0	7-49
MaxiCode Msg. Length	Minimum (1-150) *1	MAXMIN	7-49
	Maximum (1-150) *150	MAXMAX	7-49
Aztec Code	Default All Aztec Code Settings	AZTDFT	7-50
Aztec Code	*On	AZTENA1	7-50
	Off	AZTENA0	7-50
Aztec Code Msg. Length	Minimum (1-3750) *1	AZTMIN	7-50
	Maximum (1-3750) *3750	AZTMAX	7-50
Aztec Runes	Enable Runes	AZTRUN1	7-51
	*Disable Runes	AZTRUN0	7-51
<i>Imaging Default Commands</i>			
Image Snap	Default all Imaging Commands	IMGDFT	8-1
	Imaging Style - Decoding	SNPSTY0	8-1
	*Imaging Style - Photo	SNPSTY1	8-1
	Imaging Style - Manual	SNPSTY2	8-1
	Beeper On	SNPBEP1	8-1
	*Beeper Off	SNPBEP0	8-1
	Exposure (1-7874 microseconds)	SNPEXP	8-1
	*Gain - None	SNPGAN1	8-2
	Gain - Medium	SNPGAN2	8-2
	Gain - Heavy	SNPGAN4	8-2
	Gain - Maximum	SNPGAN8	8-2
	Delta for Acceptance (0-255) *25	SNPDEL###	8-2

Selection	Setting <i>* Indicates default</i>	Serial Command <i># Indicates a numeric entry</i>	Page
Image Snap (continued)	*LED State - Off	SNPLED0	8-2
	LED State - On	SNPLED1	8-2
	*Wait for Trigger Off	SNPTRG0	8-2
	Wait for Trigger On	SNPTRG1	8-2
	Update Tries (0-10) *6	SNPTRY##	8-2
	Target White Value (0-255) *125	SNPWHT###	8-2
	Target Set Point Percentage (1-99) *50	SNPPCT##	8-2
Image Ship	*Infinity Filter - Off	IMGINF0	8-3
	Infinity Filter - On	IMGINF1	8-3
	*Compensation Off	IMGCOR0	8-3
	Compensation On	IMGCOR1	8-3
	*Pixel Depth - 8 bits/pixel (grayscale)	IMGBPP8	8-3
	Pixel Depth - 1 bit/pixel (B&W)	IMGBPP1	8-3
	*Don't Sharpen Edges	IMGEDG0	8-3
	Sharpen Edges (0-23)	IMGEDG##	8-3
	*File Format - JPEG	IMGFMT6	8-3
	File Format - KIM	IMGFMT0	8-3
	File Format - TIFF binary	IMGFMT1	8-3
	File Format - TIFF binary group 4, compressed	IMGFMT2	8-3
	File Format - TIFF grayscale	IMGFMT3	8-3
	File Format - Uncompressed binary	IMGFMT4	8-3
	File Format - Uncompressed grayscale	IMGFMT5	8-3
	File Format - BMP	IMGFMT8	8-3
	*Histogram Stretch Off	IMGHIS0	8-4
	Histogram Stretch On	IMGHIS1	8-4
	*Noise Reduction Off	IMGFSP0	8-4
	Noise Reduction On	IMGFSP1	8-4
	Invert Image around X axis	IMGNVX1	8-4
Invert Image around Y axis	IMGNVY1	8-4	

Selection	Setting <i>* Indicates default</i>	Serial Command <i># Indicates a numeric entry</i>	Page
Image Ship (continued)	Rotate Image 90° right	IMGROT1	8-4
	Rotate Image 180° right	IMGROT2	8-4
	Rotate Image 90° left	IMGROT3	8-4
	JPEG Image Quality (0-100) *50	IMGJQF###	8-4
	*Gamma Correction Off	IMGGAM0	8-4
	Gamma Correction On (1-255)	IMGGAM###	8-4
	Image Crop - Left (0-640) *0	IMGWNL###	8-5
	Image Crop - Right (0-640) *639	IMGWNR###	8-5
	Image Crop - Top (0-480) *0	IMGWNT###	8-5
	Image Crop - Bottom (0-480) *479	IMGWNB###	8-5
	Image Crop - Margin (1-238) *0	IMGMAR###	8-5
	Protocol - None (raw)	IMGXFR0	8-5
	Protocol - None (default USB)	IMGXFR2	8-5
	Protocol - Hmodem	IMGXFR3	8-5
	Protocol - Hmodem Com-pressed	IMGXFR4	8-5
	Ship Every Pixel	IMGSUB1	8-5
	Ship Every 2nd Pixel	IMGSUB2	8-5
	Ship Every 3rd Pixel	IMGSUB3	8-5
	*Document Image Filter Off	IMGUSH0	8-6
	Document Image Filter On (0-255)	IMGUSH###	8-6
	*Don't Ship Histogram	IMGHST0	8-6
	Ship Histogram	IMGHST1	8-6
*Force VGA Resolution	IMGVGA1	8-6	
Native Resolution	IMGVGA0	8-6	

Selection	Setting <i>* Indicates default</i>	Serial Command <i># Indicates a numeric entry</i>	Page
<i>OCR Selections</i>			
OCR	Default All OCR Settings	OCRDFT	9-1
	OCR-A On	OCRENA1	9-2
	OCR-B On	OCRENA2	9-2
	U.S. Currency On	OCRENA3	9-2
	MICR E 13 B On	OCRENA4	9-2
	SEMI Font	OCRENA5	9-3
	* All OCR Off	OCRENA0	9-3
OCR Check Character	OCR Mod. 10 Check Char.	"OCRCHK01234 56789"	9-9
	OCR Mod. 36 Check Char.	"OCRCHK01234 56789ABCDEFGHIJ KLMNOPQRSTU- VWXYZ"	9-9
	OCR User-Defined Check Char.	OCRCHK	9-10
	3-1-3-1 Weighted Mod. 10 Check Char.	OCRCHK3-1-3-1	9-10
	2-1-2-1 Weighted Mod. 10 Check Char.	OCRCHK2-1-2-1	9-11
OCR Templates	Enter OCR Template	OCRTMP	9-13
	Enter User-Defined Variable g	OCRGPG	9-13
	Enter User-Defined Variable h	OCRGPH	9-13

4820 Product Specifications

<i>Parameter</i>	<i>Specification</i>
Dimensions (Typical):	
Height	6.2 inches (15.7 cm)
Length	5.3 inches (13.5 cm)
Width	3.2 inches (8.1 cm)
Weight	9.2 ounces (260.8 g)
Aimer:	
Illumination LEDs	626nm ±30nm
Aiming LEDs	526nm ±30nm
Image	VGA, 640x480 (4X00); 752x480 (5X00). Binary, TIFF, or JPEG output.
Skew Angle	±40 degrees
Pitch Angle	±40 degrees
Motion Tolerance	4 inches (10 cm) per second in both lateral and horizontal directions
Symbol Contrast	45% minimum for Matrix codes, 37.5% minimum for all others
Battery:	
Lithium Ion	3.6 Volt 1600 mAHr minimum
Battery Capacity:	<u>Standby</u> <u>Heavy Usage</u> (1 scan per second) 20 hours 12 hours (minimum)
Storage:	5% loss per month
Radio:	
Frequency	2.4 to 2.4835 GHz (ISM Band) Frequency Hopping Bluetooth v.1.2
Range	33 ft. (10 m) typical
Data Range	720 KBps
Temperature Ranges:	
Operating	32° F to +122° F (0° C to +50° C)
Battery Charge	41° F to +104° F (5° C to +40° C)
Storage*	-4° F to +95° F (-20° C to +35° C)
Humidity	Up to 95% non-condensing
Mechanical Drop	Operational after 50 drops from 6 feet (1.8 m) to concrete
Vibration	Withstands 5G peak from 22 to 300 Hz

ESD Sensitivity	15 kV to any external surface
MTBF	per MIL-HDBK-217F Ground Benign exceeds 71,000 hours
Sealant Rating	IP41

4820i Product Specifications

<i>Parameter</i>	<i>Specification</i>
Dimensions (Typical):	
Height	6.5 in. (16.5 cm)
Length	5.3 inches (13.5 cm)
Width	3.2 inches (8.1 cm)
Weight	9.6 oz. (272 g)
Aimer:	
Illumination LEDs	626nm \pm 30nm
Aiming LEDs	526nm \pm 30nm
Image	VGA, 640x480 (4X00); 752x480 (5X00). Binary, TIFF, or JPEG output.
Skew Angle	\pm 40 degrees
Pitch Angle	\pm 40 degrees
Motion Tolerance	4 inches (10 cm) per second in both lateral and horizontal directions
Symbol Contrast	45% minimum for Matrix codes, 37.5% minimum for all others
Battery:	
Lithium Ion	3.6 Volt 1600 mAh minimum
Battery Capacity:	<u>Standby</u> <u>Heavy Usage</u> (1 scan per second) 20 hours 12 hours (minimum)
Storage:	5% loss per month
Radio:	
Frequency	2.4 to 2.4835 GHz (ISM Band) Frequency Hopping Bluetooth v.1.2
Range	33 ft. (10 m) typical
Data Range	720 KBps
Temperature Ranges:	
Operating	14° to 122° F (-10° to 50° C)
Battery Charge	41° F to +104° F (5° C to +40° C)
Storage*	-40° to 158° F (-40° to 70° C)

Humidity	Up to 95% non-condensing
Mechanical Drop	Operational after 50 drops from 6.5 feet (1.9 m) to concrete
Vibration	Withstands 5G peak from 22 to 300 Hz
ESD Sensitivity	15 kV to any external surface
MTBF	per MIL-HDBK-217F Ground Benign exceeds 71,000 hours
Sealant Rating	IP54

*Storage outside of this temperature range could be detrimental to battery life.

2020 Product Specifications

<i>Parameter</i>	<i>Specification</i>
Dimensions (Typical):	
Height	3.1 inches (7.9 cm)
Length	5.6 inches (14.2 cm)
Width	4.3 inches (10.9 cm)
Weight	8.8 ounces (250 g)
Voltage:	
DC Barrel	8.5 to 9.5 volts
Host Port	4.5-12 volts
Current Draw:	<u>Base Only</u> <u>Base/Imager w/ max charging</u>
5 Volt Host	125 125mA (will not charge)
9 Volt DC Barrel	100 850mA
12 Volt Host	100 825mA
Charge Rate 41° F to +104° F (5° C to +40° C)	
9 Volt DC Barrel (external power)	Maximum 4 hours full charge for fully discharged battery
Temperature Ranges:	
Operating	32° F to +122° F (0° C to +50° C)
Battery Charge	41° F to +104° F (5° C to +40° C)
Storage	-40° F to +140° F (-40° C to +60° C)
Humidity	Up to 95% non-condensing
Mechanical Drop	Operational after 50 drops from 3.3 feet (1 m) to concrete
Vibration	Withstands 5G peak from 22 to 300 Hz
ESD Sensitivity	15 kV to any external surface



Sealant Rating	IP41
----------------	------

Standard Cable Pinouts

Keyboard Wedge

10 Pin RJ41 Modular Plug
connects to the base

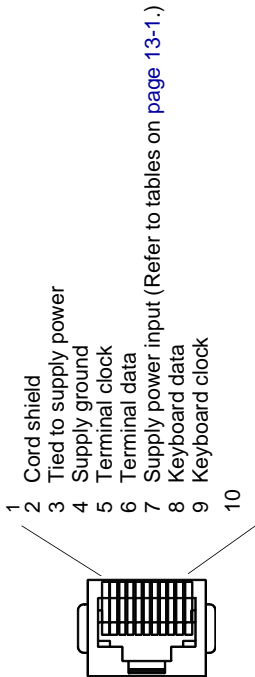

Standard Cable Pinouts

Wand Emulation

10 Pin Modular Plug
connects to the base

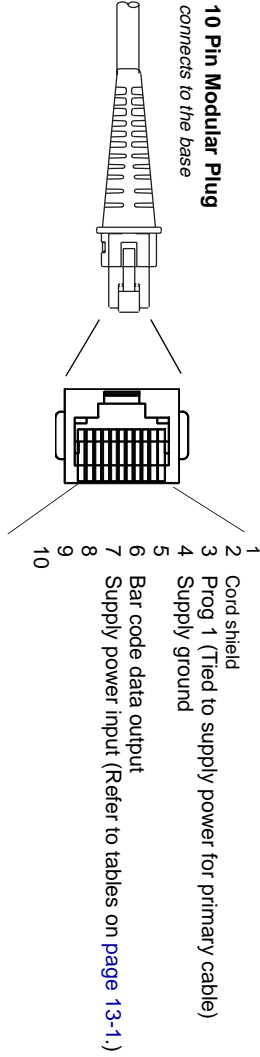

9 Pin Type D Female
connects to your terminal

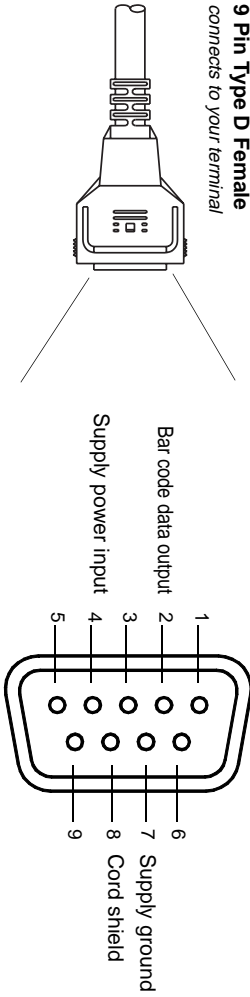

Standard Cable Pinouts

Serial Output

10 Pin RJ41 Modular Plug
connects to the base

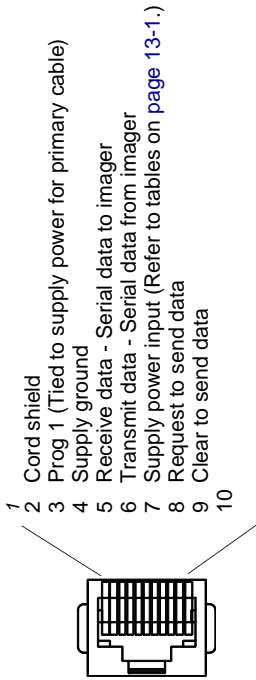

Standard Cable Pinouts

USB

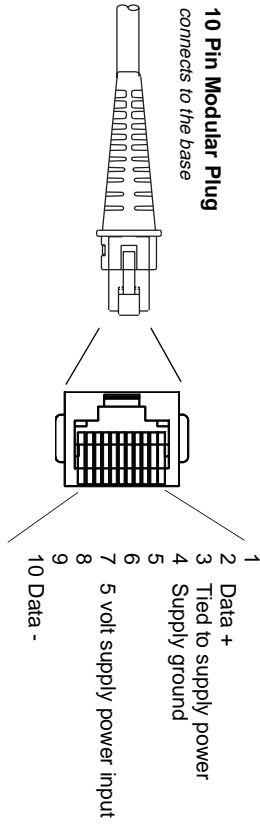

Repairs

Repairs and/or upgrades are not to be performed on this product. These services are to be performed only by an authorized service center. See "Customer Support" on page 15-1 for further information.

Maintenance

The cordless system provides reliable and efficient operation with a minimum of care. Although specific maintenance is not required, the following periodic checks ensure dependable operation:

Cleaning the Imager's Window

Reading performance may degrade if the imager's window is not clean. If the window is visibly dirty, or if the imager isn't operating well, clean the window with a soft cloth or lens tissue dampened with water (or a mild detergent- water solution). If a detergent solution is used, rinse with a clean lens tissue dampened with water only.

The imager and base's housing may also be cleaned the same way.



Caution:

Do not submerge the imager in water. The imager's housing is not watertight.

Do not use abrasive wipes or tissues on the imager's window – abrasive wipes may scratch the window. Never use solvents (e.g., alcohol or acetone) on the housing or window – solvents may damage the finish or the window.

Inspecting Cords and Connectors

Inspect the base's interface cable and connector for wear or other signs of damage. A badly worn cable or damaged connector may interfere with imager operation. Contact your Hand Held Products distributor for information about cable replacement. Cable replacement instructions are on [page 14-2](#).

Replacing the 2020 Interface Cable:

1. Turn the power to the host system OFF.
2. Disconnect the base's cable from the terminal or computer.
3. Turn the base upside down.
4. Pull the connector out while maintaining pressure on the connector release clip.
5. Replace with the new cable. Insert the connector into the opening and press firmly. The connector is keyed to go in only one way, and will click into place.

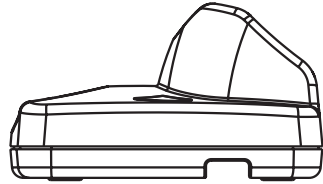

Changing the Imager Battery:

1. Remove the screw on the end cap. (For a 4820, use a Phillips screwdriver. For a 4820i, loosen the thumbwheel screw by hand, or use a flat screwdriver or hex wrench.)
2. Remove the battery from the handle.
3. Insert replacement battery.
4. Replace end cap and screw.

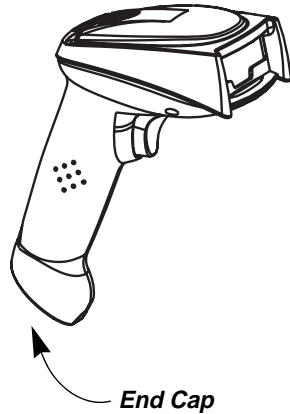

Assembling the Battery Charge Sleeve Kit

Attach Tether

1. Use the phillips screw to connect the metal ring of the coiled tether to the battery charge sleeve.



2. Peel the backing from the metal plate on the coiled tether and affix the metal plate to the back of the 2020 base.

Note: For best adhesion, allow a 24 hour cure time before placing stress on the metal plate.



Remove Battery

Remove the end cap of the imager (turn the thumbwheel or use a hex wrench).



Insert Battery into Charge Sleeve

1. Place the squared-off end of the battery into the sleeve and slide it until it stops. The battery contacts should be showing through the small rectangular opening in the battery sleeve.
2. Press other end of the battery until you feel a click.



Charge Battery

With the battery inside the battery charge sleeve, place the battery charge sleeve into the base with the battery contacts going in first and facing up.



Troubleshooting Base

Note: Please visit the [Services and Support](http://www.handheld.com) section of our website (www.handheld.com) to check for the latest software for both the imager and the base.

If your base is not functioning properly, review the following troubleshooting guidelines to try to isolate the problem.

Is the red LED on?

If the red LED isn't illuminated, check that:

- The power cable is connected properly and there is power at the power source.
- The host system power is on (if external power isn't used).

Is the green LED on?

If the *green* LED isn't illuminated, check that:

- The imager is correctly placed in the base.
- There is external power or 12 volt host power.
- Charge mode is turned on. (See "[Base Charge Mode](#)" on page 3-3)

-
- The battery is not bad or deeply discharged. In some cases, the imager's battery may trickle charge to bring it into an acceptable level and then transition to a normal charge cycle.

Troubleshooting Imager

Note: Make sure that your imager's battery is charged.

Note: Please visit the Services and Support section of our website (www.handheld.com) to check for the latest software for both the imager and the base.

Is the imager having trouble reading your symbols?

If the imager isn't reading symbols well, check that the symbols:

- Aren't smeared, rough, scratched, or exhibiting voids.
- Aren't coated with frost or water droplets on the surface.
- Are enabled in the base to which the imager connects.

Is the bar code displayed but not entered into the application?

The bar code is displayed on the host device correctly, but you still have to press a key to enter it (the Enter/Return key or the Tab key, for example).

You need to program a suffix. Programming a suffix enables the imager to output the bar code data plus the key you need (such as "CR") to enter the data into your application. Refer to [Prefix/Suffix Overview](#) on page 5-1 for further information.

Does the imager read the bar code incorrectly?

If the imager reads a bar code, but the data is not displayed correctly on the host screen:

- The base may not be programmed for the appropriate terminal interface. For example, you scan "12345" and the host displays "@es%."

Reprogram the base with the correct Plug and Play or Terminal selection bar code. See [Chapter 1](#) and [Chapter 2](#).

- The base may not be programmed to output your bar code data properly. For example, you scan "12345" and the host displays "A12345B."

Reprogram the base with the proper symbology selections. See [Chapter 7](#).

The imager won't read your bar code at all.

1. Scan the sample bar codes in the back of this manual. If the imager reads the sample bar codes, check that your bar code is readable. Verify that your bar code symbology is enabled (see [Chapter 7](#)).
2. If the imager still can't read the sample bar codes, scan [All Symbologies](#) on page 7-2.



Product Service and Repair

Hand Held Products provides service for all its products through service centers throughout the world. To obtain warranty or non-warranty service, return the unit to Hand Held Products (postage paid) with a copy of the dated purchase record attached. Contact the appropriate location below to obtain a Return Material Authorization number (RMA #) before returning the product.

North America

Hand Held Products Corporate Offices
Telephone: (800) 782-4263, option 3
Fax: (704) 566-6015
E-mail: naservice@handheld.com

América Latina

Hand Held Products América Latina
Teléfono: (704) 998-3998, opción 8, opción 4
Teléfono: (800) 782-4263, opción 8, opción 3
Fax: (239) 263-9689
E-mail: laservice@handheld.com

Brasil

Hand Held Products Rio de Janeiro
Telephone: +55 (21) 2178-0500
Fax: +55 (21) 2178-0505
E-mail: brservice@handheld.com

México

Hand Held Products México
Teléfono: +52 (55) 5203-2100
Fax: +52 (55) 5531-3672
E-mail: mxservice@handheld.com

Europe, Middle East, and Africa

Hand Held Products Europe
Telephone: +31 (0) 40 2901 633
Fax: +31 (0) 40 2901 631
E-mail: euservice@handheld.com

Asia Pacific

Hand Held Products Asia/Pacific
Telephone: +852-2511-3050
Fax: +852-2511-3557
E-mail: apservice@handheld.com

Japan

Hand Held Products Japan
Telephone: +81-3-5770-6312
Fax: +81-3-5770-6313
E-mail: apservice@handheld.com

Online Product Service and Repair Assistance

You can also access product service and repair assistance online at www.handheld.com.

Technical Assistance

If you need assistance installing or troubleshooting, please call your Distributor or the nearest Hand Held Products technical support office:

North America/Canada

Telephone: (800) 782-4263, option 4 (8 a.m. to 6 p.m. EST)
Fax number: (315) 685-4960
E-mail: natechsupport@handheld.com

América Latina

Teléfono: (704) 998-3998, opción 8, opción 3
Teléfono: (800) 782-4263, opción 8, opción 3
E-mail: latechsupport@handheld.com

Brasil

Telefone: +55 (21) 2178-0500
Fax: +55 (21) 2178-0505
E-mail: brtechsupport@handheld.com

México

Teléfono: (704) 998-3998, opción 8, opción 3
E-mail: latechsupport@handheld.com

Europe, Middle East, and Africa

Telephone: +31 (0) 40 7999 393
Fax: +31 (0) 40 2425 672
E-mail: eurosupport@handheld.com

Asia Pacific

Telephone - Hong Kong: +852-3188-3485 or 2511-3050
Telephone - China: +86 21 6361 3818
E-mail: apttechsupport@handheld.com

Online Technical Assistance

You can also access technical assistance online at www.handheld.com.

Limited Warranty

Hand Held Products, Inc. ("Hand Held Products") warrants its products to be free from defects in materials and workmanship and to conform to Hand Held Products published specifications applicable to the products purchased at the time of shipment. This warranty does not cover any Hand Held Products product which is (i) improperly installed or used; (ii) damaged by accident or negligence, including failure to follow the proper maintenance, service, and cleaning schedule; or (iii) damaged as a result of (A) modification or alteration by the purchaser or other party, (B) excessive voltage or current supplied to or drawn from the interface connections, (C) static electricity or electro-static discharge, (D) operation under conditions beyond the specified operating parameters, or (E) repair or service of the product by anyone other than Hand Held Products or its authorized representatives.

This warranty shall extend from the time of shipment for the duration published by Hand Held Products for the product at the time of purchase ("Warranty Period"). Any defective product must be returned (at purchaser's expense) during the Warranty Period to Hand Held Products factory or authorized service center for inspection. No product will be accepted by Hand Held Products without a Return Materials Authorization, which may be obtained by contacting Hand Held Products. In the event that the product is returned to Hand Held Products or its authorized service center within the Warranty Period and Hand Held Products determines to its satisfaction that the product is defective due to defects in materials or workmanship, Hand Held Products, at its sole option, will either repair or replace the product without charge, except for return shipping to Hand Held Products.

EXCEPT AS MAY BE OTHERWISE PROVIDED BY APPLICABLE LAW, THE FOREGOING WARRANTY IS IN LIEU OF ALL OTHER COVENANTS OR WARRANTIES, EITHER EXPRESSED OR IMPLIED, ORAL OR WRITTEN, INCLUDING, WITHOUT LIMITATION, ANY IMPLIED WARRANTIES OF MERCHANTABILITY OR FITNESS FOR A PARTICULAR PURPOSE.

HAND HELD PRODUCTS' RESPONSIBILITY AND PURCHASER'S EXCLUSIVE REMEDY UNDER THIS WARRANTY IS LIMITED TO THE REPAIR OR REPLACEMENT OF THE DEFECTIVE PRODUCT. IN NO EVENT SHALL HAND HELD PRODUCTS BE LIABLE FOR INDIRECT, INCIDENTAL, OR CONSEQUENTIAL DAMAGES, AND, IN NO EVENT, SHALL ANY LIABILITY OF HAND HELD PRODUCTS ARISING IN CONNECTION WITH ANY PRODUCT SOLD HEREUNDER (WHETHER SUCH LIABILITY ARISES FROM A CLAIM BASED ON CONTRACT, WARRANTY, TORT, OR OTHERWISE) EXCEED THE ACTUAL AMOUNT PAID TO HAND HELD PRODUCTS FOR THE PRODUCT. THESE LIMITATIONS ON LIABILITY SHALL REMAIN IN FULL FORCE AND EFFECT EVEN WHEN HAND HELD PRODUCTS MAY HAVE BEEN ADVISED OF THE POSSIBILITY OF SUCH INJURIES, LOSSES, OR DAMAGES. SOME STATES, PROVINCES, OR COUNTRIES DO NOT ALLOW THE EXCLUSION OR LIMITATIONS OF INCIDENTAL OR CONSEQUENTIAL DAMAGES, SO THE ABOVE LIMITATION OR EXCLUSION MAY NOT APPLY TO YOU.

All provisions of this Limited Warranty are separate and severable, which means that if any provision is held invalid and unenforceable, such determination shall not affect the validity of enforceability of the other provisions hereof. Hand Held Products, Inc. extends these warranties only to the first end-users of the products. These warranties are nontransferable.

The limited duration of the warranty for the 2020 and 4820/4820i is for three (3) years. The limited duration of the warranty for the imager battery is for one (1) year.

Appendix A

Symbology Chart

Symbology	AIM ID	Possible AIM ID Modifiers (<i>m</i>)	Hand Held Products Code ID (hex)
<i>All Symbologies</i>			(0x99)
4-CB (4-State Customer Bar Code)]X0		M (0x4D)
Australian Post]X0		A (0x41)
Aztec Code]zm	0-9, A-C	z (0x7A)
British Post]X0		B (0x42)
Canadian Post]X0		C (0x43)
China Post]X0		Q (0x51)
Codabar]F <i>m</i>	0-1	a (0x61)
Codablock F]O <i>m</i>	0, 1, 4, 5, 6	q (0x71)
Code 11]H3		h (0x68)
Code 128]C <i>m</i>	0, 1, 2, 4	j (0x6A)
Code 16K]K <i>m</i>	0, 1, 2, 4	o (0x6F)
Code 32 Pharmaceutical (PARAF)]X0		< (0x3C)
Code 39]A <i>m</i>	0, 1, 3, 4, 5, 7	b (0x62)
Code 49]T <i>m</i>	0, 1, 2, 4	l (0x6C)
Code 93 and 93i]G <i>m</i>	0-9, A-Z, a-m	i (0x69)
Data Matrix]d <i>m</i>	0-6	w (0x77)
EAN-13]E0		d (0x64)
EAN-8]E4		D (0x44)
EAN•UCC Composite]e <i>m</i>	0-3	y (0x79)
EAN-13 with Extended Coupon Code]E3		d (0x64)
ID-tag (UPU 4-State)]X0		N (0x4E)
Interleaved 2 of 5]l <i>m</i>	0, 1, 3	e (0x65)
Japanese Post]X0		J (0x4A)
KIX (Netherlands) Post]X0		K (0x4B)
Korea Post]X0		? (0x3F)

Symbology	AIM ID	Possible AIM ID Modifiers (m)	Hand Held Products Code ID (hex)
Matrix 2 of 5	⌋X0		m (0x6D)
MaxiCode	⌋Um	0-3	x (0x78)
MicroPDF417	⌋Lm	3-5	R (0x52)
MSI	⌋Mm	0	g (0x67)
No Read			(0x9C)
OCR-A	⌋o1		O (0x4F)
OCR-B	⌋o2		O (0x4F)
OCR MICR E-13B	⌋ZE		O (0x4F)
OCR US Money Font	⌋o3		O (0x4F)
SEMI Font	⌋o3		O (0x4F)
PDF417	⌋Lm	0-2	r (0x72)
Planet Code	⌋X0		L (0x4C)
Plessey Code	⌋P0		n (0x6E)
PosiCode	⌋pm	0, 1, 2	W (0x57)
Postnet	⌋X0		P (0x50)
QR/Micro QR Code	⌋Qm	0-6	s (0x73)
Reduced Space Symbology (RSS-14, RSS Limited, RSS Expanded)	⌋em	0	y (0x79)
Straight 2 of 5 IATA (two-bar start/stop)	⌋Rm	0, 1, 3	f (0x66)
Straight 2 of 5 Industrial (three-bar start/stop)	⌋S0	0, 1, 3	f (0x66)
TCIF Linked Code 39 (TLC39)	⌋L2		T (0x54)
Telepen	⌋Bm	0, 1, 2, 4	t (0x74)
Trioptic Code	⌋X0		= (0x3D)
UCC/EAN-128	⌋C1		l (0x49)
UPC-A	⌋E0		c (0x63)
UPC-A with Extended Coupon Code	⌋E3		c (0x63)
UPC-E	⌋E0		E (0x45)
VeriCode*	⌋X0		v (0x76)

* Only available by special order.

Note: “m” represents the AIM modifier character. Refer to International Technical Specification, Symbology Identifiers, for AIM modifier character details.

Note: Prefix/Suffix entries for specific symbologies override the universal (All Symbologies, 99) entry.

Refer to [Data Editing](#) beginning on page 5-1 and [Data Formatting](#) beginning on page 6-1 for information about using Code ID and AIM ID.

ASCII Conversion Chart (Code Page 1252)

Note: This table applies to U.S. style keyboards. Certain characters may differ depending on your Country Code/PC regional settings.

Dec	Hex	Char	Dec	Hex	Char	Dec	Hex	Char	Dec	Hex	Char
0	00	NUL	32	20		64	40	@	96	60	'
1	01	SOH	33	21	!	65	41	A	97	61	a
2	02	STX	34	22	"	66	42	B	98	62	b
3	03	ETX	35	23	#	67	43	C	99	63	c
4	04	EOT	36	24	\$	68	44	D	100	64	d
5	05	ENQ	37	25	%	69	45	E	101	65	e
6	06	ACK	38	26	&	70	46	F	102	66	f
7	07	BEL	39	27	'	71	47	G	103	67	g
8	08	BS	40	28	(72	48	H	104	68	h
9	09	HT	41	29)	73	49	I	105	69	i
10	0A	LF	42	2A	*	74	4A	J	106	6A	j
11	0B	VT	43	2B	+	75	4B	K	107	6B	k
12	0C	FF	44	2C	,	76	4C	L	108	6C	l
13	0D	CR	45	2D	-	77	4D	M	109	6D	m
14	0E	SO	46	2E	.	78	4E	N	110	6E	n
15	0F	SI	47	2F	/	79	4F	O	111	6F	o
16	10	DLE	48	30	0	80	50	P	112	70	p
17	11	DC1	49	31	1	81	51	Q	113	71	q
18	12	DC2	50	32	2	82	52	R	114	72	r
19	13	DC3	51	33	3	83	53	S	115	73	s
20	14	DC4	52	34	4	84	54	T	116	74	t
21	15	NAK	53	35	5	85	55	U	117	75	u
22	16	SYN	54	36	6	86	56	V	118	76	v
23	17	ETB	55	37	7	87	57	W	119	77	w
24	18	CAN	56	38	8	88	58	X	120	78	x
25	19	EM	57	39	9	89	59	Y	121	79	y
26	1A	SUB	58	3A	:	90	5A	Z	122	7A	z
27	1B	ESC	59	3B	;	91	5B	[123	7B	{
28	1C	FS	60	3C	<	92	5C	\	124	7C	
29	1D	GS	61	3D	=	93	5D]	125	7D	}
30	1E	RS	62	3E	>	94	5E	^	126	7E	~
31	1F	US	63	3F	?	95	5F	_	127	7F	

Dec.	Hex	Char	Dec.	Hex	Char	Dec.	Hex	Char	Dec.	Hex	Char
128	80	€	160	A0		192	C0	À	224	E0	à
129	81	□	161	A1	¡	193	C1	Á	225	E1	á
130	82	,	162	A2	¢	194	C2	Â	226	E2	â
131	83	f	163	A3	£	195	C3	Ã	227	E3	ã
132	84	„	164	A4	¤	196	C4	Ä	228	E4	ä
133	85	...	165	A5	¥	197	C5	Å	229	E5	å
134	86	†	166	A6	¦	198	C6	Æ	230	E6	æ
135	87	‡	167	A7	§	199	C7	Ç	231	E7	ç
136	88	^	168	A8	¨	200	C8	È	232	E8	è
137	89	‰	169	A9	©	201	C9	É	233	E9	é
138	8A	Š	170	AA	ª	202	CA	Ê	234	EA	ê
139	8B	‹	171	AB	«	203	CB	Ë	235	EB	ë
140	8C	Œ	172	AC	¬	204	CC	Ì	236	EC	ì
141	8D	□	173	AD	-	205	CD	Í	237	ED	í
142	8E	Ž	174	AE	®	206	CE	Î	238	EE	î
143	8F	□	175	AF	¯	207	CF	Ï	239	EF	ï
144	90	□	176	B0	°	208	D0	Ð	240	F0	ð
145	91	‘	177	B1	±	209	D1	Ñ	241	F1	ñ
146	92	’	178	B2	²	210	D2	Ò	242	F2	ò
147	93	“	179	B3	³	211	D3	Ó	243	F3	ó
148	94	”	180	B4	´	212	D4	Ô	244	F4	ô
149	95	•	181	B5	µ	213	D5	Õ	245	F5	õ
150	96	—	182	B6	¶	214	D6	Ö	246	F6	ö
151	97	—	183	B7	·	215	D7	×	247	F7	÷
152	98	˜	184	B8	¸	216	D8	Ø	248	F8	ø
153	99	™	185	B9	¹	217	D9	Ù	249	F9	ù
154	9A	š	186	BA	º	218	DA	Ú	250	FA	ú
155	9B	›	187	BB	»	219	DB	Û	251	FB	û
156	9C	œ	188	BC	¼	220	DC	Ü	252	FC	ü
157	9D	□	189	BD	½	221	DD	Ý	253	FD	ý
158	9E	ž	190	BE	¾	222	DE	Þ	254	FE	þ
159	9F	ÿ	191	BF	¿	223	DF	ß	255	FF	ÿ

Code Page Mapping of Printed Bar Codes

Code pages define the mapping of character codes to characters. If the data received does not display with the proper characters, it may be because the bar code being scanned was created using a code page that is different from the one the host program is expecting. If this is the case, select the code page with which the bar codes were created. The data characters should then appear properly.

Note: The Code Page option is available for Code 39, Code 93, and Code 128.

Code Page	Standard	Description
1	CP ISO646	
2 (Default)	ISO 2022	Automatic National Replacement Characters
3	CP Binary	
82	ISO 2022 11 Swe	Swedish Replacement Characters
83	ISO 2022 69 Fra	French/Belgium Replacement Characters
81	ISO 2022 25 Fra	French/Belgium Replacement Characters
84	ISO 2022 11 Ger	German Replacement Characters
85	ISO 2022 11 Ita	Italian Replacement Characters
86	ISO 2022 11 Swi	Swiss Replacement Characters
87	ISO 2022 11 UK	British Replacement Characters
88	ISO 2022 11 Dan	Danish Replacement Characters
89	ISO 2022 11 Nor	Norwegian Replacement Characters
90	ISO 2022 11 Spa	Spanish Replacement Characters



Sample Symbols

UPC-A

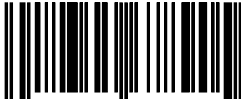

0 123456 7890

Interleaved 2 of 5



1234567890

Code 128



Code 128

EAN-13



9 780330 290951

Code 39

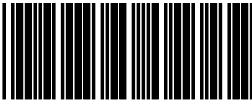

BC321

Codabar

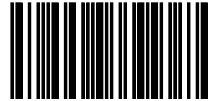

A13579B

Code 93

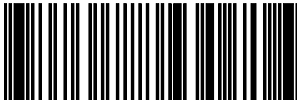

123456-9\$

Straight 2 of 5 Industrial

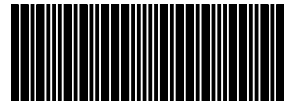

123456

Sample Symbols

Matrix 2 of 5



6543210

RSS-14



(01)00123456789012

PDF417



Car Registration

Postnet



Zip Code

Code 49



1234567890

Data Matrix



Test Symbol

QR Code



Numbers

4-CB (4-State Customer Bar Code)



01,234,567094,987654321,01234567891

ID-tag (UPU 4-State)



J18CUSA8E6N062315014880T

Sample Symbols

Aztec



Package Label

MaxiCode

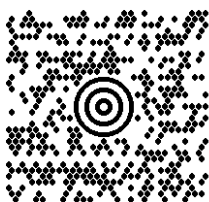

Test Message

Micro PDF417



Test Message

**OCR-B with Modulo 10
check character**

5324277

**OCR-A with Modulo 36
check character**

532427D

OCR Programming Chart



a



d



g



l



t



Discard



c



e



h



r



Save

Programming Chart



A



B



C



D



E



F



0



1



2



3

Programming Chart



4



6



8



Save



Reset



5



7



9



Discard

*Note: If you make an error while scanning the letters or digits (before scanning Save), scan Discard, scan the correct letters or digits, and **Save** again.*

Hand Held Products, Inc.

700 Visions Drive

P.O. Box 208

Skaneateles Falls, NY 13153-0208