



METROLOGIC INSTRUMENTS, INC.
MS1633 FocusBT™ with
Bluetooth® Wireless Technology
Area Imaging Bar Code Scanner
Installation and User's Guide



Copyright

© 2008 by Metrologic Instruments, Inc. All rights reserved. No part of this work may be reproduced, transmitted, or stored in any form or by any means without prior written consent, except by reviewer, who may quote brief passages in a review, or provided for in the Copyright Act of 1976.

Trademarks

Metrologic is a registered trademark of Metrologic Instruments, Inc. Products identified in this document are hereby acknowledged as trademarks, registered or otherwise, of Metrologic Instruments, Inc. or their respective companies.

The *Bluetooth* word mark and logos are owned by the Bluetooth SIG, Inc. and any use of such marks by Metrologic Instruments, Inc. is under license. Other trademarks and trade names are those of their respective owners.

TABLE OF CONTENTS

Introduction

Product Overview	1
Scanner and Accessories	2
Scanner Components	3
Labels	4
Maintenance	5

Getting Started

Battery Tips and Cautions	6
Charger Status Indicators	6
Charging the Battery	7
Battery Installation	8
Low Battery Warning	8
Removing the Battery for Charging	8

Driver Installation

Driver Installation for USB Adapter with <i>Bluetooth</i> Technology	9
Auto Reconnect Driver Setup	12
FocusBT Connection Configuration	14

Establishing Communication via *Bluetooth* Technology

When FocusBT Acts as a Server to Other Devices	16
When FocusBT Acts as a Client to Other Devices	17
When FocusBT is Used with an MS9535 Cradle	18
Range Gate Mode	18
Inventory Mode	19

Stand Kits

Stand Components, MLPN 46-00147	20
Hard Mounting the Stand	21
Assembling the Stand	22

TABLE OF CONTENTS

Scanner Operation

Two Default Modes of Operation	23
Audible Indicators	24
Visual Indicators	25
Failure Modes.....	26
Depth of Field by Minimum Bar Code Element Width	27
IR Activation Range.....	28

Troubleshooting Guide	29
-----------------------------	----

Design Specifications	33
-----------------------------	----

Default Settings – Communication Parameters.....	35
--------------------------------------------------	----

Configuration Modes	37
---------------------------	----

Upgrading the Flash ROM Firmware.....	38
---------------------------------------	----

Limited Warranty	39
------------------------	----

Regulatory Compliance

Safety	40
EMC	41

Patents	43
---------------	----

Index	44
-------------	----

Contact Information and Office Locations.....	46
-----------------------------------------------	----

Product Overview

FocusBT™ is an Area Imager enabled with *Bluetooth*® wireless technology that outperforms the competition by integrating advanced features to both hand-held and presentation mode scanning such as *FirstFlash*® scanning, automatic aim line, object detection and *RangeGate*® to optimize efficiency and productivity while providing the freedom of mobility.

FocusBT has been designed with a removable battery pack for remote charging to decrease down time caused by having a dead battery. Two battery packs are supplied so the user can simultaneously scan while remotely charging the spare battery. The benefits of this feature are 24/7 scanning and increased throughput for all enterprise applications.

FocusBT is the industry leader in Area Imaging and the added benefits of *Bluetooth* technology along with a rich feature set, make it the scanner of choice for 2D wireless applications.

FocusBT™	Interface
MS1633 – 5	BT Interface 1.2 <i>Bluetooth</i> technology Profile Supported: SPP (Serial Port Profile)
	Decoding and functional capability of the unit is restricted through the use of license numbers provided by Metrologic. Units will not support key features such as, but not limited to, the ability to decode PDF, 2D or OCR fonts without the proper licenses. Desired licenses can be specified at the time of sale or call a Metrologic representative for more information. Standard models ship with the ability to read all 1D, PDF and 2D bar codes. OCR fonts are disabled by default and must be specifically requested at an additional cost.

Scanner and Accessories

BASIC KIT		
Part #	Description	Qty.
MS1633	MS1633 FocusBT Area Imaging Bar Code Scanner	1
70-72018	Li-Ion Battery Pack	2
46-00358	Battery Charger	1
00-05176	USB BT adaptor	1
00-02544	MetroSelect® Single-Line Configuration Guide*	1
00-02281	Supplemental Configuration Guide*	1
46-00374	Software CD	1
00-02280	MS1633 FocusBT Installation and User's Guide*	1

* Available on the Metrologic website - www.metrologic.com

OPTIONAL ACCESSORIES	
Part #	Description
AC to DC Power Transformer - 5.2VDC @ 2 A output.	
46-46915	120V United States
46-46913	220V-240V Continental European
46-46912	220V-240V United Kingdom
46-46914	220V-240V Australia
46-46911	220V-240V China
00-02001	MS1633 Focus Stand (46-00147) Installation Guide
46-00147	Modular Presentation Stand

Other items may be ordered for the specific protocol being used. To order additional items, contact the dealer, distributor or call Metrologic's Customer Service Department at 1-800-ID-METRO or 1-800-436-3876.

Scanner and Charger Components

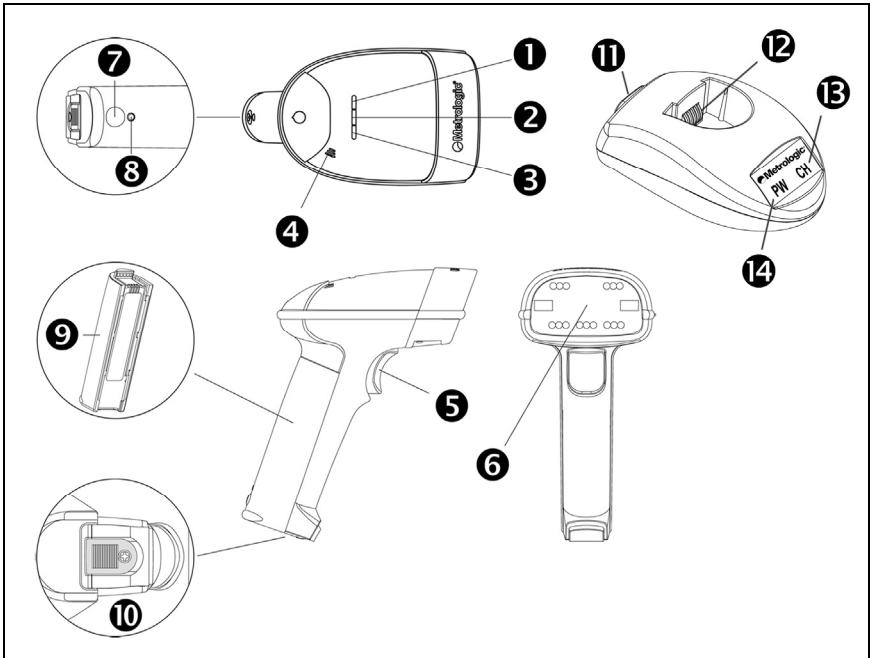

Figure 1. Scanner and Charger Components

		Item Description
1	Yellow LED	See <i>Visual Indicators</i> (on page 25)
2	White LED	See <i>Visual Indicators</i> (on page 25)
3	Blue LED	See <i>Visual Indicators</i> (on page 25)
4	Speaker	See <i>Audible Indicators</i> (on page 24)
5	Trigger	
6	Red Window	LED Aperture
7	Power Button	See <i>Charging the Battery</i> (on page 8)
8	Blue Power LED	See <i>Charging the Battery</i> (on page 7)
9	Battery Pack	See <i>Battery Installation</i> (on page 8)
10	Lock	See <i>Battery Installation</i> (on page 8)
11	Power Jack	See <i>Battery Installation</i> (on page 8)
12	Charging Contacts	See <i>Battery Installation</i> (on page 7)
13	Blue Power LED	See <i>Charger Status Indicators</i> (on page 6)
14	White Charge LED	See <i>Charger Status Indicators</i> (on page 6)

INTRODUCTION

Labels

Each scanner has a label located on the underside of the head. This label provides the unit's model number, date of manufacture, serial number, CE and caution information. The charger, the USB Adapter and the battery also have labels with important safety and compliance information. The following figure provides examples of these labels and their locations.

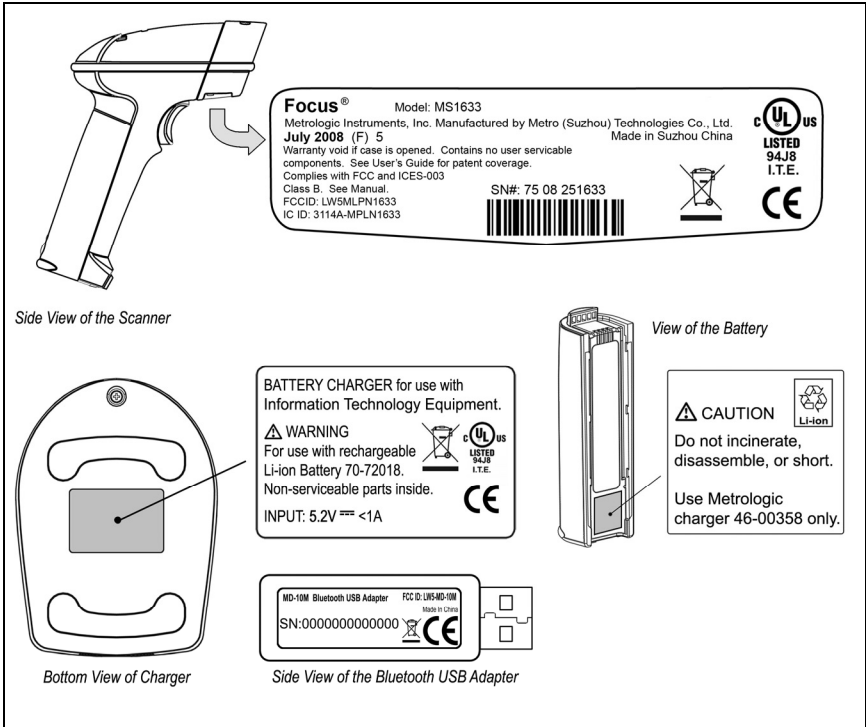



Figure 2. Label Locations and Samples

Caution:

 To maintain compliance with applicable standards, all circuits connected to the scanner must meet the requirements for SELV (Safety Extra Low Voltage) according to EN/IEC 60950-1.

To maintain compliance with standard CSA-C22.2 No. 60950-1/UL 60950-1 and norm EN/IEC 60950-1, the power source should meet applicable performance requirements for a limited power source.

Maintenance

Smudges and dirt on the unit's window can interfere with the unit's performance. If the window requires cleaning, use only a mild glass cleaner containing no ammonia. When cleaning the window, spray the cleaner onto a lint free, non-abrasive cleaning cloth then gently wipe the window clean.

If the unit's case requires cleaning, use a mild cleaning agent that does not contain strong oxidizing chemicals. Strong cleaning agents may discolor or damage the unit's exterior.

Battery Tips and Cautions

Before the FocusBT can be placed in operation the battery pack must be charged for a minimum of 8 hours. After the initial preparation charge of 8 hours, the battery will only require 6 hours to come to a full charge when it gives a *Low Battery* warning (see page 8). Follow the steps on page 7 to fully charge the battery.

Once charged, the unit is able to handle 5400 continuous first pass readings over a period of approximately 9 hours. After 30 seconds of no activity the scanner will go into a sleep mode to conserve battery life.

Caution

Observe proper precautions when handling batteries.

Batteries may leak or explode if improperly handled. Observe the following precautions when handling batteries for use in this product:

- Be sure the battery is turned off before replacing the battery.
- Be sure the battery is turned off when installed in the charger.
- Use only batteries approved for use in this equipment.
Do not mix old and new batteries or batteries of different types.
- Do not attempt to insert the battery upside down or backwards.
- Do not short or disassemble the battery.
- Do not expose the battery to flame or excessive heat.
- Do not immerse the battery in water or expose it to water.
- Do not transport or store with metal objects such as necklaces or hairpins.
- Batteries are prone to leakage when fully discharged.
To avoid damage to the product, be sure to remove the battery when no charge remains.
- When not in use store the battery in a cool dry place.
- Discontinue use immediately should you notice any changes in the battery, such as discoloration or deformation.
- Please recycle used batteries in accordance with local regulations.

Charger Status Indicators

There are two status indicators on the front of the charger located under the Metrologic Logo. The following table lists how these indicators will illuminate depending on the status of the charger.

CHARGER STATUS	BLUE LED (PW)	WHITE LED (CH)
Charging	On	Blinking
Fully Charged	On	Solid
Power On	On	OFF
Power Off	OFF	OFF

Charging the Battery

Before the FocusBT can be placed in operation for the first time, the battery must be charged for a minimum of 8 hours. After the initial preparation charge of 8 hours, the battery will only require 6 hours to come to a full charge when it gives a Low Battery warning (see page 8).

1. Check the AC input requirements of the power supply to make sure the voltage matches the AC outlet. The outlet should be located near the charger and easily accessible.
2. Plug the power supply into the socket on the back of the charger.

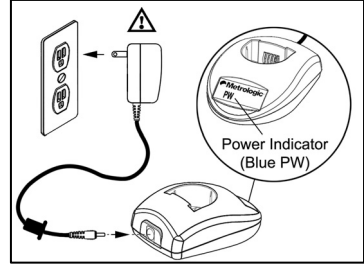

Figure 3

A blue **PW** will illuminate near the Metrologic logo indicating the charger is receiving power.

3. Verify that the battery pack is not ON. The blue power LED on the battery pack should be OFF.

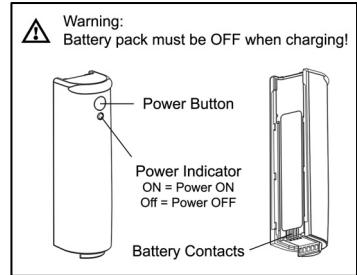

Figure 4

Warning!
Damage to the battery pack can occur if it is charged while turned ON.

4. Insert the battery pack into the charger as shown in Figure 5.

A white **CH** will start to flash on and off on the charger near the Metrologic logo.

If the white **CH** does not appear, check to make sure the battery pack is seated all the way in the charger with the battery contacts facing the contacts on the charger.

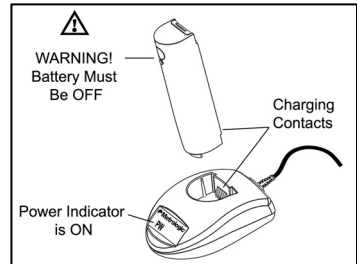

Figure 5

5. When the battery is completely charged the charging indicator (**CH**) will stop flashing and stay illuminated.

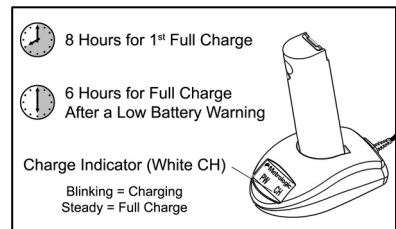

Figure 6

Battery Installation

MS1633 FocusBT is a battery powered scanner. **Before the FocusBT can be placed in operation for the first time, the battery must be charged for a minimum of 8 hours.**

To install the battery:

1. Align the tabs of the charged battery pack with the slots on the scanner's handle
2. Then, slide the battery pack up toward the top of the scanner. There will be a snap when the battery is installed correctly.

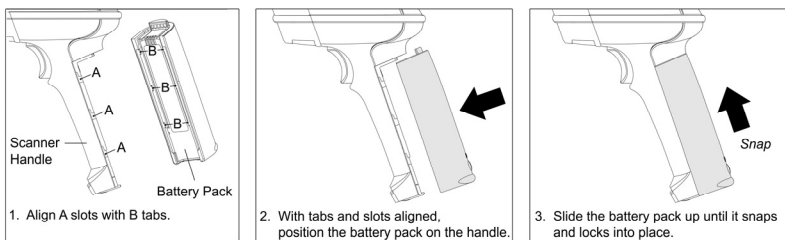

Figure 7. Steps for Installing the Battery

Low Battery Warning

When the battery is low the unit will add an additional beep after the *good scan beep*. The additional beep alerts the user when there is less than 10% of a charge left on the battery.

Removing the Battery for Charging

In order to charge the battery, it must be disconnected from the scanner.

1. Turn off the battery by pressing the button near the base of the battery.
2. Disengage the lock on end of the scanner handle (see below).
3. Slide the battery pack down away from the head of the scanner.
4. Lift the battery straight off the scanner handle (see below).

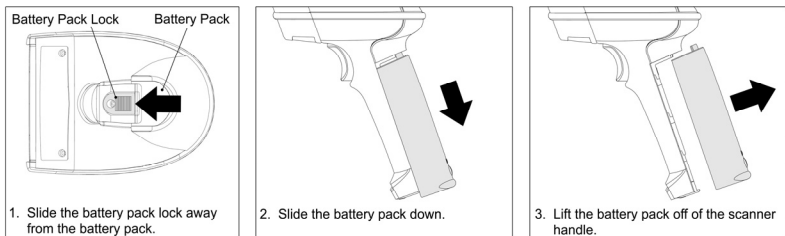

Figure 8. Steps for Removing the Battery for Charging

Driver Installation for USB Adapter with *Bluetooth* Technology

1. Load the included FocusBT CD into the CD-ROM drive on the host/computer.
2. If the CD-ROM does not automatically open, click on the Window's **Start** button, choose **Run**, then click **Browse** to locate and open the CD-ROM drive. Double-Click on the **Metrologic.exe** file then click **OK**.
3. Click on the **MetroBT Driver** button to begin installation.

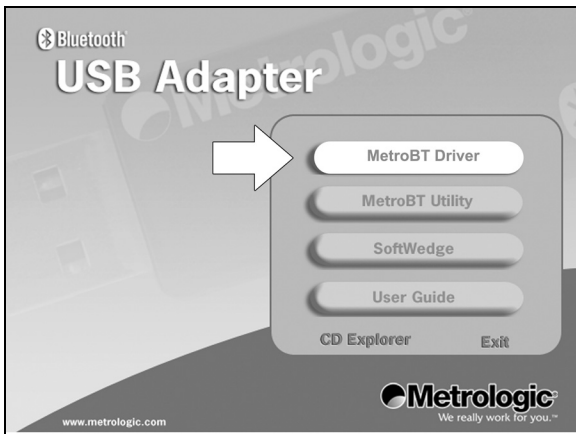

Figure 9.

4. Choose a **Setup Language** then click **OK**.

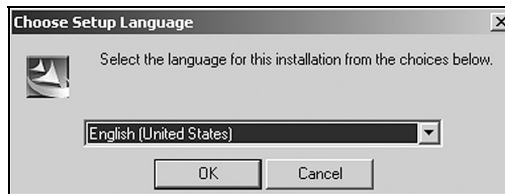

Figure 10.

Driver Installation for USB Adapter with *Bluetooth* Technology

- At the welcome screen select **Next**.

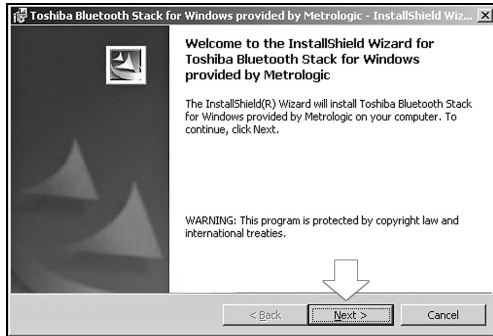

Figure 11.

- After reviewing the end user license agreement, **select** the, "I accept the terms in the license agreement" option then, click **Next** to continue.

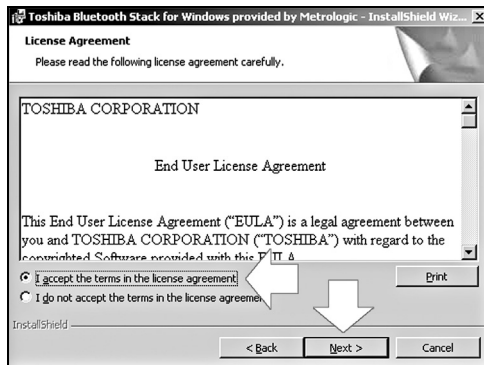

Figure 12.

- Choose **Install** from the *Ready to Install the Program* screen.



Figure 13.

Driver Installation for USB Adapter with *Bluetooth* Technology

- To continue the installation procedure without showing warnings for unauthorized drivers, select **I accept** and click **OK**.

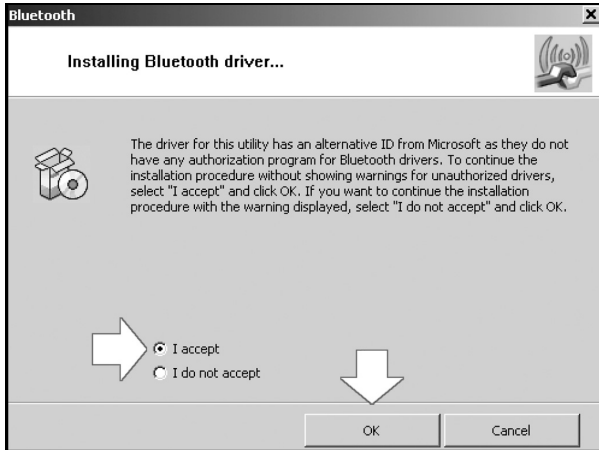

Figure 14.

- Plug the *Bluetooth* USB Adapter into the host device then click **OK** to indicate the *Bluetooth* Adapter has been connected.

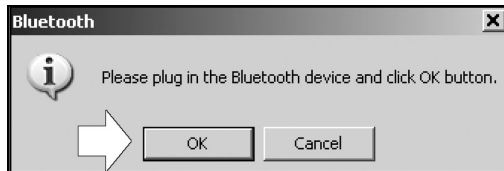

Figure 15.

- After the installation completes click on **Yes** to restart the host device/computer. The host/computer must be rebooted at this time in order for the driver to function properly.

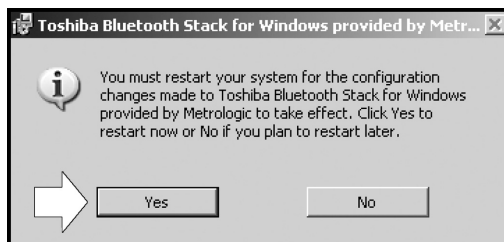

Figure 16.

Auto Reconnect Driver Setup

1. Load the included FocusBT CD into the CD-ROM drive on the host/computer.
2. If the CD-ROM does not automatically open, click on the Window's **Start** button, choose **Run**, then click **Browse** to locate and open the CD-ROM drive. Double-Click on the **Metrologic.exe** file then click **OK**.
3. Click on the **MetroBT Utility** button to begin installation.

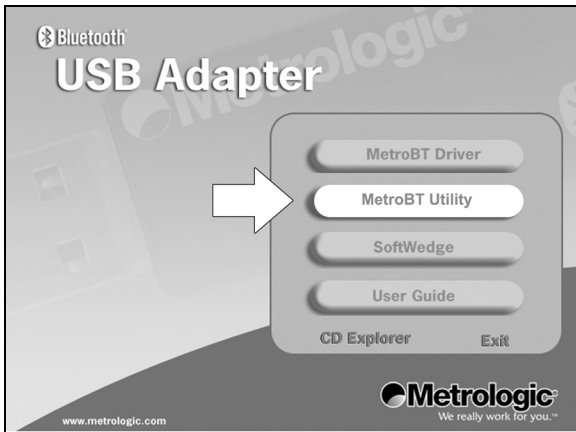

Figure 17.

4. Click **OK** to continue.

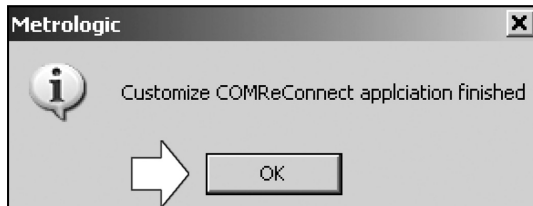

Figure 18.

5. Locate the COMReConnect icon on the Windows desktop and **double click** to open the program.



Figure 19.

Auto Reconnect Driver Setup

- The Auto Reconnect Utility will automatically start if any of the COM ports with *Bluetooth* technology are checked. When running, the utility window will look like the figure below.

Clicking the "X" in the corner of the window or clicking on the close button will disable the auto-reconnect feature. However, if the *Place icon in the taskbar* option is checked, the utility will remain active after the window is closed.

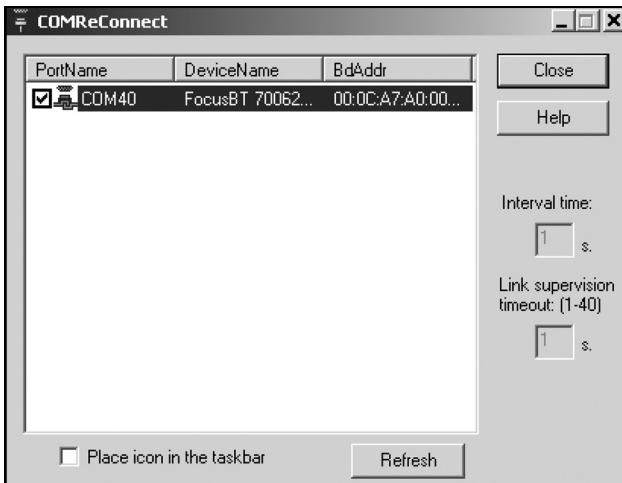

Figure 20.

FocusBT Connection Configuration

1. Double-Click on the *Bluetooth* icon located on the Windows Start bar in the bottom right corner of the screen.
2. The new connection wizard will automatically start.

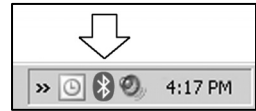

Figure 21.

Power up the FocusBT scanner and allow it to boot completely. Three beeps will indicate the scanner is completely booted.

Select **Express Mode** then click **Next**.

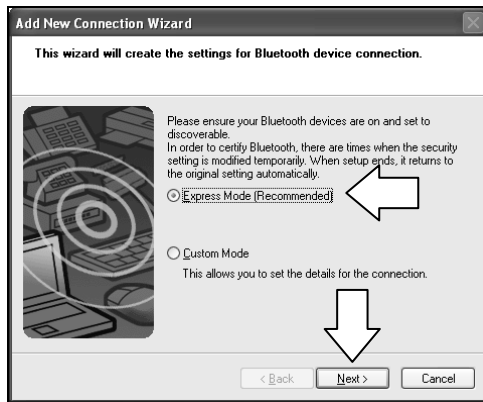

Figure 22.

3. A search for *Bluetooth* wireless technology devices should find the FocusBT. The number(s) next to FocusBT indicate the serial number of the unit(s) found.

Select the proper device and click **Next** to continue.

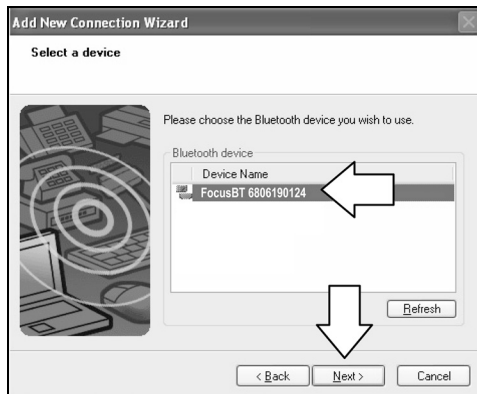

Figure 23.

FocusBT Connection Configuration

- The final screen of the *New Connection Wizard* should indicate the virtual *Bluetooth* Com port that was setup. This will usually be a high number, as seen in the screen shot below. **Remember this COM number for application setup.**

Click **Next** to Continue.



Figure 24.

- After the FocusBT has been added to the connection list, right click on the icon and select **Connect** in order to establish a link via *Bluetooth* technology between the FocusBT and your computer.

The FocusBT should emit a connection tone and/or the blue light on the top of the unit should stop blinking, indicating a connection has been established.

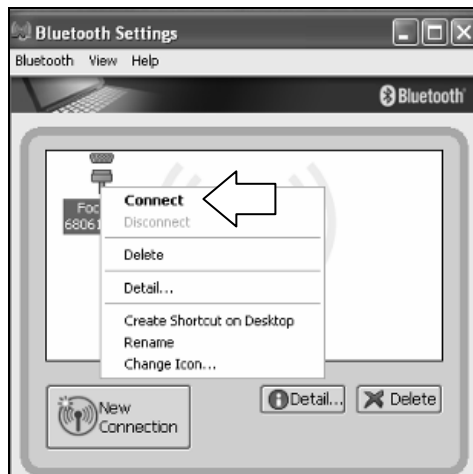

Figure 25.

Communication via *Bluetooth* wireless technology must be established between the *FocusBT* and the host device before the *FocusBT* can be used for normal operation.

In a network with *Bluetooth* technology, the *FocusBT* can operate as a server (service-provide mode), or as a client.

When *FocusBT* Acts as a Server to Other Devices with *Bluetooth* Technology

FocusBT's default is to act as a server to other devices with *Bluetooth* technology. In this mode, other devices enabled with *Bluetooth* wireless technology can initiate a connection to the scanner.

FocusBT can be configured to always accept incoming connection requests and not require a valid *Bluetooth* PIN. Alternatively, *FocusBT* can be configured to require a valid *Bluetooth* PIN. In this case, the PIN used by a remote device while establishing connection to the *FocusBT*, must match the one previously stored in *FocusBT*.

****Bluetooth* PIN Not Required**



***Bluetooth* PIN Required**



To store a *Bluetooth* PIN

The *FocusBT* can be configured to store a *Bluetooth* PIN so that any remote device trying to establish a connection with the scanner, must match the stored PIN before a connection will be made. The stored PIN must be numeric and be between 4 to 16 digits long. A PIN that does not satisfy the criteria will not be stored.

After scanning the following bar code, the next bar code scanned will be stored and used as the *Bluetooth* PIN. This feature is used in conjunction with the *Bluetooth* PIN required feature.

Next bar code is *Bluetooth* PIN

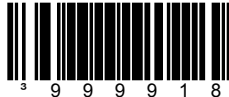

Scanning the *Recall Defaults* bar code resets the PIN to the default value of 0000.

When FocusBT Acts as a Client to Other Devices with *Bluetooth* Technology

In the client device mode of operation, the FocusBT initiates the connection via *Bluetooth* wireless technology. The *Bluetooth* address of the remote device is required to establish a connection. The remote device must also be configured to accept incoming connections and must support the *Bluetooth* wireless technology Serial Port (SPP) profile.

- If the *Bluetooth* address of the remote device is headed with **FNC3** and consists of a 12-digit hex value (e.g. ³000CA7000118), scan the address bar code to establish the communication.

Sample of a 12-digit *Bluetooth* Address with FNC3



- If the *Bluetooth* address of the remote device is **not** headed with **FNC3** but is just a common 12-digit hex value (e.g. 000CA7000118), first scan the *Get Bluetooth Address* bar code then scan the remote device's *Bluetooth* address bar code.

Get *Bluetooth* Address



- If the *Bluetooth* address code of the remote device is set to **000CA7000000**, FocusBT will automatically go into *server mode* and will not attempt to establish an outgoing connection via *Bluetooth* wireless technology.



To return to *service mode*:

Scan the bar code below to change FocusBT from *client mode* to *service mode*.

*Provide *Bluetooth* Service



When Focus*BT* is Used with an MS9535 Cradle

Focus*BT* can be configured to communicate with an MS9535 cradle but it will require the Focus*BT* to be configured to use a special communication protocol used by the MS9535 cradle. Scan the **Enable MS9535 Cradle Protocol** bar code below to enable the special communication protocol.



The Focus*BT* cannot be configured or flash-upgraded via an MS9535 cradle. Communication settings of the cradle cannot be changed by scanning configuration bar codes with the Focus*BT*. Support for the MS9535 cradle is limited to bar code transmission.

Do not forget to disable the MS9535 cradle protocol when the cradle is no longer in use.

Enable MS9535 cradle protocol*



***Disable MS9535 cradle protocol**



RangeGate[®] Mode

The operation range of the communication via *Bluetooth* technology is at least 10 meters between the scanner and host system. When Focus*BT* is out of operation range for *Bluetooth* technology, the communication link will break and the blue LED will start to flash on the scanner.

Focus*BT* can be configured to store scanned bar codes into the non-volatile memory when the connection for *Bluetooth* technology is inactive. The scanner will transmit the bar codes and erase them from memory once the connection for *Bluetooth* technology is re-established. The size of the non-volatile memory is 32768 bytes.

Scan the following bar codes to enable or disable Range Gate Mode.

Enable Range Gate



***Disable Range Gate**



Inventory Mode

In Inventory mode, there is a quantity field associated with each bar code. Similar to RangeGate mode, the data is stored in the scanner's non-volatile memory. However, in inventory mode, the data is always stored independent of whether the connection for *Bluetooth* technology is active or not, and is not uploaded automatically until a special bar code is scanned.

For the bar codes associated with this mode, please consult the *FocusBT* Supplemental Configuration Guide (MLPN 00-02281A).



RangeGate and Inventory Mode are mutually-exclusive. If both are enabled, Inventory mode takes priority.

Stand Components, MLPN 46-00147

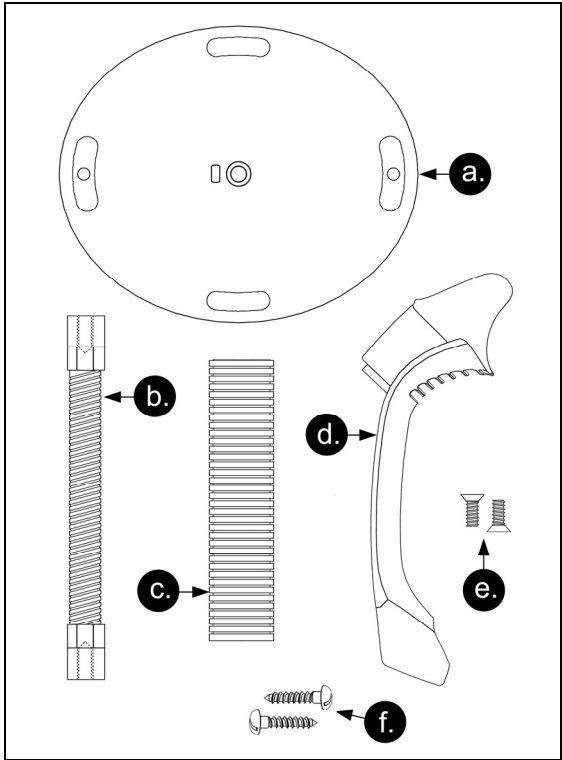

Figure 26. Stand Components

Item	Description	Qty.
a.	Stand Base	Qty. 1
b.	Flexible Shaft	Qty. 1
c.	Flexible Shaft Cover	Qty. 1
d.	Scanner Cradle	Qty. 1
e.	1/4" – 20 x 3/8" Flat Head Phillips, 100° Undercut	Qty. 2
f.	#8 Round Head Wood Screw	Qty. 2

Hard Mounting the Stand (Optional)

Metrologic provides two #8 wood screws for securing the stand base to the counter top. The following figure provides the pilot hole dimensions for securing the stand base.

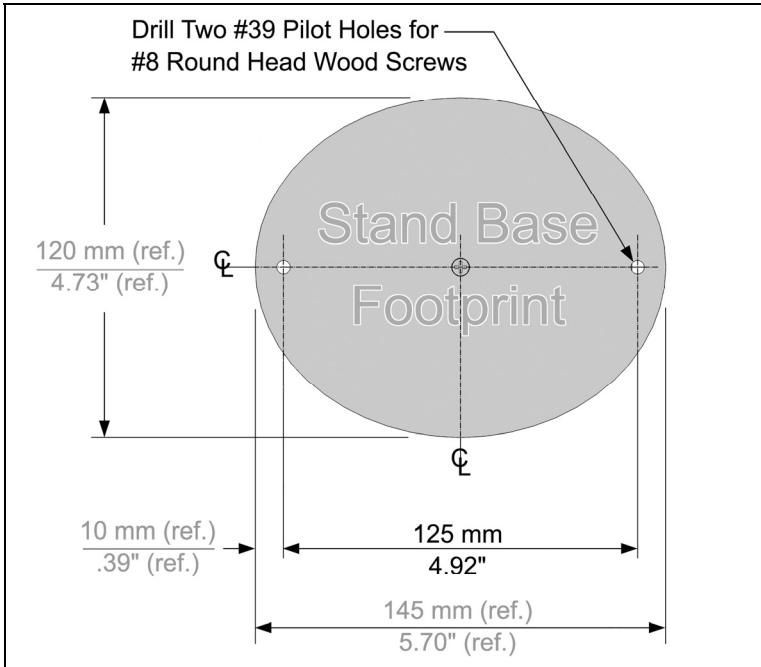

Figure 27. Stand Base Hole Pattern (Not to Scale)

Assembling the Stand

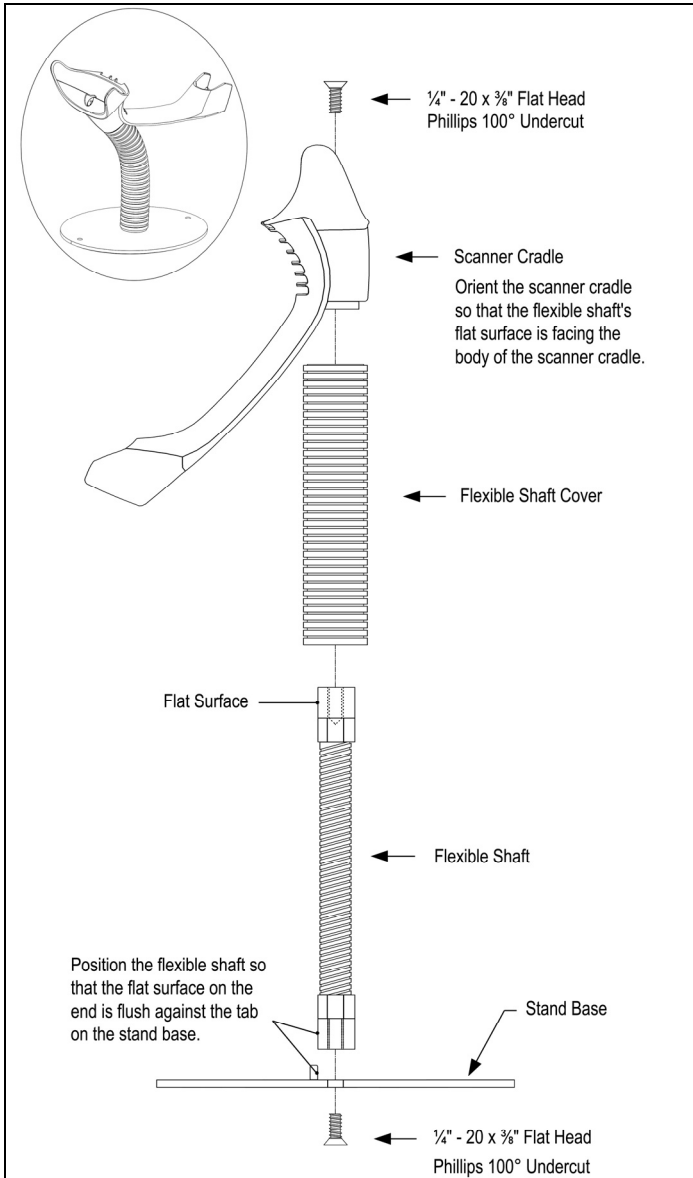



Figure 28. Assembling the Stand

Two Default Modes of Operation*

Multi-Trigger Mode, Out-of-Stand

1. The IR detects an object in the IR activation range and automatically turns on linear illumination.
2. Aim the scanner's line of light over the bar code.
3. Pull the trigger to initiate scanning. The scanner's light output will start to flash as it attempts to scan the bar code.

 If the trigger is released the scanner will stop trying to scan.

4. When scanner successfully reads the bar code it will beep once, the white LED will flash and the decoded data will be transmitted to the host.

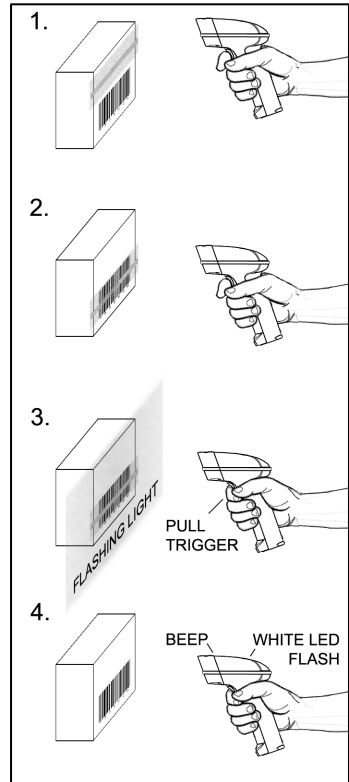

Figure 29. Multi-Trigger Mode, Out-of-Stand

Presentation, In-Stand

1. The IR detects an object in the IR activation range and the scanner's light output automatically starts to flash as it attempts to scan the bar code.
2. The scanner continuously attempts to scan the bar code until either it succeeds or the bar code is removed from the scanner's field of view.
3. When scanner successfully reads the bar code it will beep once, the white LED will flash and the decoded data will be transmitted to the host.

* For additional configurable modes of operation, please refer to the Area Imaging Bar Code Supplemental Configuration Guide (MLPN 00-02281).

Audible Indicators

When the FocusBT is in operation, it provides audible feedback. These sounds indicate the status of the scanner. Eight settings are available for the tone of the beep (normal, six alternate tones and no tone). To change the tone, refer to the MetroSelect Single-Line Configuration Guide (MLPN 00-02544) or MetroSet2's help files.

One Beep

When the scanner *successfully* reads a bar code it will beep once and the white LED will turn on indicating data is being transmitted.

If the scanner does not beep once and the white light does not turn on, then the bar code has *not* been successfully read.

Short Razzberry Tone

This tone is a failure indicator (see Failure Modes on page 26).

Long Razzberry Tone

This tone is a failure indicator (see Failure Modes on page 26).

Three Beeps - At Power Up

When FocusBT first receives power it will start an initialization sequence. All LEDs (yellow, white, and blue) will light for approximately two seconds then start to alternately flash. When the scanner has finished initializing the LEDs will stop flashing and the unit will beep three times indicating that the scanner is ready for use.

Three Beeps - Configuration Mode

When entering configuration mode, the white LED will flash while the scanner simultaneously beeps three times. The white and blue LEDs will continue to flash while in this mode. Upon exiting configuration mode, the scanner will beep three times, and the LEDs will stop flashing.

When configured, three beeps can also indicate a communications timeout during normal scanning mode.

When using single-code-configuring, the scanner will beep three times: a normal tone followed by a short pause, a high tone and then a low tone. This indicates that the single configuration bar code has successfully configured the scanner.

Low Battery Tone

When the battery is low the unit will add an additional beep after the *good scan beep*. The additional beep alerts the user when there is less than 10% of a charge left on the battery.

Audible Indicators

Low to High Beep

This tone indicates the connection via *Bluetooth* technology has been made.

High to Low Beep

This tone indicates the connection via *Bluetooth* technology is disconnected.

A Double Razz Tone

When the communication link for *Bluetooth* technology is not active, the scanner will emit a double razz tone and the Blue LED will start to flash. This can occur when the scanner is out of the communication range for *Bluetooth* technology from the host system and the RangeGate feature is disabled.

Visual Indicators

The MS1633 has three LED indicators (yellow, white and blue) located on the top of the scanner. When the scanner is on, the flashing or stationary activity of the LEDs indicates the status of the current scan and the scanner.

No LEDs are Illuminated

The LEDs will not be illuminated if the scanner is not receiving power from the host or transformer.

The scanner is in stand-by mode. Present a bar code to the scanner and the blue LED will turn on when the IR detects the object.

Steady Yellow

The yellow LED is illuminated when the scanner is in the stand.

Steady Blue

The blue LED is illuminated when the scanner is active and linear illumination is on or when the scanner is attempting to decode a bar code.

Steady Blue and Single White Flash

When the scanner successfully reads a bar code it will beep once and the white LED will turn on indicating data is being transmitted.

If the scanner does not beep once and the white light does not turn on, then the bar code has not been successfully read.

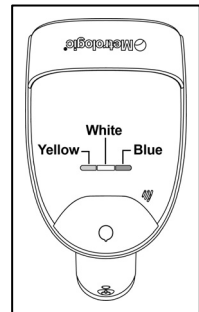

Figure 30.

Visual Indicators

Steady White

When the scanner successfully reads a bar code it will beep once and the white LED will turn on indicating data is being transmitted.



After a successful scan, the scanner transmits the data to the host device. Some communication modes require that the host inform the scanner when data is ready to be received. If the host is not ready to accept the information, the scanner's white LED will remain on until the data can be transmitted.

Alternating Flashing of Blue and White

This indicates the scanner is in configuration mode. A short razzberry tone indicates that an invalid bar code has been scanned while in this mode.

Flashing Blue

The blue LED will flash if the trigger is pressed while the scanner is in the in-stand presentation mode. The blue LED will stop flashing after a brief period of time.

The operation range of communication for *Bluetooth* wireless technology is approximately 10 meters between the scanner and host system. If the unit is out of range, the communication link will break, the blue LED will start to flash, and the unit will emit a double razz tone. The blue LED will continue to blink for 30 seconds while the unit is out of range. If RangeGate or Inventory mode are not enabled, the scanner will enter sleep mode to conserve battery power after 30 seconds.

Failure Modes

Long Razzberry Tone – During Power Up

Failed to initialize or configure the scanner. If the scanner does not respond after reprogramming, return the scanner for repair.

Short Razzberry Tone – During Scanning

An invalid bar code has been scanned when in configuration mode or the trigger has been pulled too fast.

Depth of Field by Minimum Bar Code Element Width

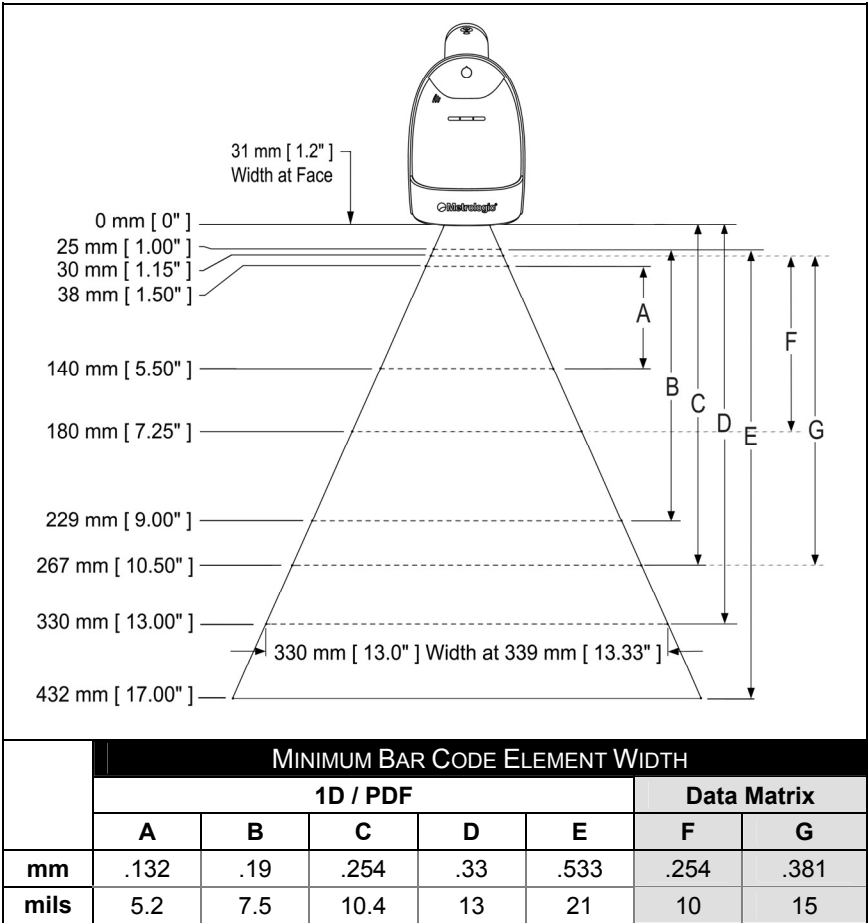



Figure 31. Depth of Field by Minimum Bar Code Element Width

 Decoding and functional capability of the unit is restricted through the use of license numbers provided by Metrologic. Units will not support key features such as, but not limited to, the ability to decode PDF, 2D or OCR fonts without the proper licenses. Desired licenses can be specified at the time of sale or call a Metrologic representative for more information. Standard models ship with the ability to read all 1D, PDF and 2D bar codes. OCR fonts are disabled by default and must be specifically requested at an additional cost.

Specifications are subject to change without notice.

IR Activation Range

The MS1633 has a built in object detection sensor that instantly turns on the scanner when an object is presented within the scanner's IR activation area.

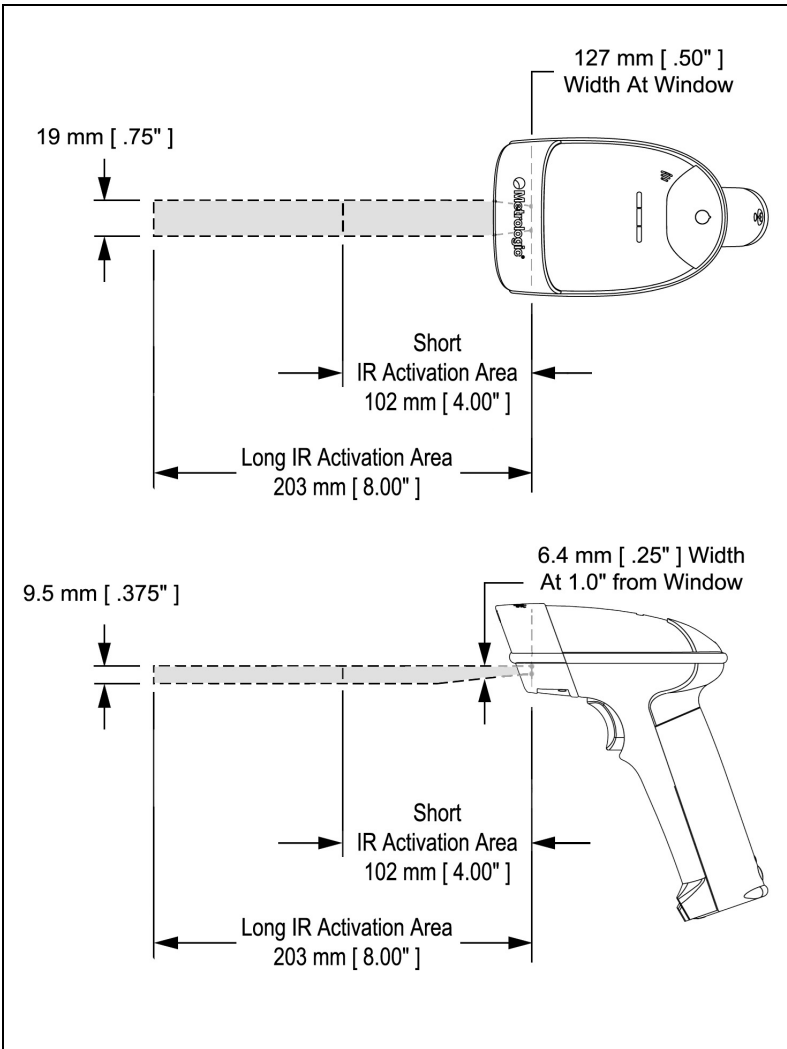

Figure 32. IR Activation Area

Specifications are subject to change without notice.

TROUBLESHOOTING GUIDE

The following guide is for reference purposes only. Contact a Metrologic representative at 1-800-ID-Metro or 1-800-436-3876 to preserve the limited warranty terms.

All Interfaces

MS1633 Series Troubleshooting Guide		
Symptoms	Possible Causes	Solution
No LEDs, beep or illumination.	No power is being supplied to the scanner.	<p>Check to make sure the battery is turned on.</p> <p>Check to make sure the battery is properly installed.</p> <p>The battery may need to be charged.</p>
Long Razz tone on power up.	There has been a diagnostic failure.	Contact a Metrologic service representative, if the unit will not function.
Long Razz tone when exiting configuration mode.	There was a failure saving the new configuration.	Re-try to configure the scanner. Contact a Metrologic Service Representative if the unit will not hold the saved configuration.
Long Razz tone.	There is a scanning mechanism failure.	Contact a Metrologic service representative.
Short Razz tone in configuration mode.	An invalid bar code has been scanned.	Scan a valid bar code or quit configuration mode.

TROUBLESHOOTING GUIDE

Symptoms	Possible Causes	Solution
The unit powers up, but does not beep when bar code is scanned.	The beeper is disabled and no tone is selected.	Enable the beeper and select a tone.
The unit powers up, but does not scan and/or beep.	The bar code symbology trying to be scanned is not enabled.	UPC/EAN, Code 39, interleaved 2 of 5, Code 93, Code 128, Codabar and PDF are enabled by default. Verify that the type of bar code being read has been selected.
The unit powers up, but does not scan and/or beep.	The scanner is trying to scan a bar code that does not match the configured criteria.	Verify that the bar code being scanned falls into the configured criteria (i.e. character length lock or minimum bar code length settings).
The unit scans a bar code, but locks up after the first scan and the white LED stays on.	The scanner is configured to support some form of host handshaking but is not receiving the signal.	If the scanner is setup to support ACK/NAK, check to make sure the host is supporting the handshaking properly.
The unit scans, but the data transmitted to the host is incorrect.	The scanner's data format does not match the host system requirements.	Verify that the scanner's data format matches that required by the host.

TROUBLESHOOTING GUIDE

Symptoms	Possible Causes	Solution
The unit beeps at some bar codes and NOT for others of the same bar code symbology.	The bar code may have been printed incorrectly.	Check if it is a check digit/character/or border problem.
	The scanner is not configured correctly for this type of bar code.	Check if check digits are set properly.
	The minimum symbol length setting does not work with the bar code.	Check if the correct minimum symbol length is set.
The unit scans the bar code but there is no data.	The configuration is not set correctly.	Make sure the scanner is configured for the appropriate mode.
The unit scans but the data is not correct.	The scanner and host may not be configured for the same interface parameters.	Check that the scanner and the host are configured for the same interface parameters.
The unit is transmitting each character twice.	The configuration is not set correctly.	Increase interscan code delay setting. Adjust whether the F0 break is transmitted. It may be necessary to try this in both settings.
Alpha characters show as lower case.	The computer is in Caps Lock mode.	Enable Caps Lock detect setting of the scanner to detect if the PC is operating in Caps Lock.

TROUBLESHOOTING GUIDE

Symptoms	Possible Causes	Solution
Everything works except for a couple of characters.	These characters may not be supported by that country's key look up table.	Try operating the scanner in Alt mode.
The unit powers up OK and scans OK but does not communicate properly with the host.	The USB adapter may not be connected properly	Check to make sure the USB adapter is connected properly.
Characters are being dropped.	Inter-character delay needs to be added to the transmitted output.	Add some inter-character delay to the transmitted output by using the Configuration Guides (MLPN 00-02544 and 00-02065).

DESIGN SPECIFICATIONS

MS1633 DESIGN SPECIFICATIONS		
OPERATIONAL		
Light Source:	LED 645 nm	
Pulse Duration:	10 μ s to 8000 μ s	
Maximum Output:	0.76 mW Peak	
Depth of Scan Field:	0 mm – 330 mm (0" – 13") for 0.330 mm (13 mil) Bar Code at Default Setting	
Field of View:	49 mm W x 19 mm H (1.9" W x 0.8" H) at 20 mm (0.8")	
	264 mm x 106 mm (10.4" W x 4.2" H) at 280 mm (11.0")	
Minimum Bar Width:	0.127 mm (5.0 mil)	
Infrared Activation:	Long Range: 0 mm – 203 mm (0" – 8") from Window	
	Short Range: 0 mm – 101 mm (0" – 4") from Window	
Motion Tolerance:	47 cm/sec (18"/sec) 100% UPC in stand	
Decode Capability:	Autodiscriminates All Standard 1-D, GS1 Databar, PDF417, microPDF, MaxiCode, Data Matrix, QR Code, UCC, EAN Composites, Postals, Aztec	
Image Transfer*:	BMP, TIFF, or JPEG output <i>*RS232 and USB only</i>	
Print Contrast:	20% Minimum Reflectance Difference	
Number Characters Read:	Up to 80 Data Characters on 1D; 1850 Text Characters for PDF417	
Beeper Operation:	7 tones or no beep	
Indicators (LED) <i>Default Settings:</i>	Blue	Unit Powered, Ready to Scan
	White	Good Read
	Yellow	In Stand

 Decoding and functional capability of the unit is restricted through the use of license numbers provided by Metrologic. Units will not support key features such as, but not limited to, the ability to decode PDF, 2D or OCR fonts without the proper licenses. Desired licenses can be specified at the time of sale or call a Metrologic representative for more information. Standard models ship with the ability to read all 1D, PDF and 2D bar codes. OCR fonts are disabled by default and must be specifically requested at an additional cost.

Specifications are subject to change without notice.

DESIGN SPECIFICATIONS

		MS1633 DESIGN SPECIFICATIONS	
MECHANICAL			
Height:	183 mm (7.2")		
Width:	Handle	30 mm (1.2")	
	Head	79 mm (3.1")	
Depth:	111 mm (4.9")		
Weight:	290 g (10.23 oz)		
ELECTRICAL			
Input Voltage:	5.2VDC \pm 0.25V		
Power:	Peak = 2 W (Typical)		
	Operating = 1.65 W (Typical)		
	Idle / Standby = 800 mW (Typical)		
Current:	Operation = 400 mA (Typical)		
	Idle / Standby = 100 mA (Typical)		
DC Transformer:	Class 2; 5.2VDC @ 2A		
For regulatory compliance information see pages 40 – 42.			
ENVIRONMENTAL			
Temperature:	Operating = 0°C to 40° (32° to 104°F)		
	Storage = -20°C to 50°C (-4°F to 122°F)		
Humidity:	0% to 95% Relative Humidity, Non-Condensing		
Light Levels:	Up to 190,000 Lux (17,670 Footcandles)		
Shock:	Designed to withstand 1.5 m (5') drops		
Contaminants:	Sealed to resist airborne particulate contaminants		
Ventilation:	None required		

Specifications are subject to change without notice.

DEFAULT SETTINGS – COMMUNICATION PARAMETERS

Many functions of the scanner can be “configured” – that is, enabled or disabled. The scanner is shipped from the factory configured to a set of default conditions. The default parameter of the scanner has an asterisk (*) in the charts on the following pages. If an asterisk is not in the default column then the default setting is OFF or DISABLED.

PARAMETER	DEFAULT
Multi-Try Trigger Out-of-Stand	*
Presentation Mode In-Stand	*
Continuous Trigger	
Single Trigger	
Aiming in Trigger and Continuous Modes	*
Aiming in Presentation Mode	
Long-Range In-Stand	*
Short-Range In-Stand	
Long-Range Out-of-Stand	*
Short-Range Out-of-Stand	
RangeGate Mode	
Inventory Mode	
UPC/EAN	*
Code 128	*
Code 93	*
Codabar	*
Interleaved 2 of 5 (ITF)	*
MOD 10 check on ITF	
Code 11	
Code 39	*
Full ASCII Code 39	
PDF	*

PARAMETER	DEFAULT
Data Matrix	
QR Code	
Maxicode	
Aztec	
Postals	
Mod 43 Check on Code 39	
MSI-Plessey 10/10 Check Digit	
MSI-Plessey Mod 10 Check Digit	*
Paraf Support ITF	
ITF Symbol Lengths	Variable
Symbol Length Lock	None
Beeper tone	Normal
Beep/transmit sequence	Before transmit
Communication timeout	None
Razzberry tone on timeout	
Three beeps on timeout	
Same symbol rescan timeout: 1000 msecs	*
Same symbol rescan timeout configurable in 50 msec steps (maximum of 6.35 sec.)	
No Same symbol timeout	
Infinite Same symbol timeout	

DEFAULT SETTINGS – COMMUNICATION PARAMETERS

PARAMETER	DEFAULT
Inter-character delay configurable in 1 msec steps (maximum of 255 msec)	1 msec 10 msec in KBW
Number of scan buffers (<i>maximum</i>)	8
Transmit UPC-A check digit	*
Transmit UPC-E check digit	
Expand UPC-E	
Convert UPC-A to EAN-13	
Transmit lead zero on UPC-E	
Transmit UPC-A number system	*
Transmit UPC-A Manufacturer ID#	*
Transmit UPC-A Item ID#	*
Transmit Codabar Start/Stop Characters	
CLSI Editing (Enable)	
Transmit Mod 43 Check digit on Code 39	
Transmit Mod 10/ITF	
Transmit MSI-Plessey	
Transmit Sanyo ID Characters	
Nixdorf ID	
LRC Enabled	
UPC Prefix	
UPC Suffix	
Carriage Return	*
Tab Prefix	

PARAMETER	DEFAULT
Tab Suffix	
"DE" Disable Command	
Enable Command	
ACK/NAK	
Two Digit Supplements	
Five Digit Supplements	
Bookland	
977 (2 digit) Supplemental Requirement	
Supplements are not Required	*
Two Digit Redundancy	*
Five Digit Redundancy	
Coupon Code 128	
† Configurable Code Lengths	7 avail
† Code Selects with configurable Code Length Locks	3 avail
Configurable Prefix characters	10 avail
Suffix characters	10 avail
Prefixes for Individual Code types	
Editing	
Function/Control Key Support	*
Omnidirectional Scanning	*
Linear Only Scanning	
Linear 1D / Omni 2D	

† *These options are mutually exclusive. One can not be used in conjunction with the other.*

CONFIGURATION MODES

The MS1633 Focus*BT* Series has three modes of configuration.

- **Bar Codes**

The MS1633 can be configured by scanning the bar codes included in the Metrologic Single-Line Configuration Guide (MLPN 00-02544). This manual can be downloaded for FREE from Metrologic's website (www.metrologic.com).

- **MetroSet2**

This user-friendly Windows-based configuration program allows you to simply 'point-and-click' at the desired scanner options. This program can be downloaded for FREE from Metrologic's website (www.metrologic.com) or set-up disks can be ordered by calling 1-800-ID-METRO.

- **Serial Configuration**

This mode of configuration is ideal for OEM applications. This mode gives the end-user the ability to send a series of commands using the serial port of the host system. The commands are equivalent to the numerical values of the bar codes located in the MetroSelect Single-Line Configuration Guide (MLPN 00-02544).

UPGRADING THE FLASH ROM FIRMWARE

The MS1633 FocusBT is part of Metrologic's line of scanners with flash upgradeable firmware. The upgrade process requires a new firmware file supplied to the customer by a customer service representative♦ and Metrologic's MetroSet2 software♦♦. A personal computer running Windows 2000 or greater with an available USB port is also required to complete the upgrade.



FocusBT can only be upgraded via USB using a *Bluetooth* USB Adapter dongle (MLPN 00-05176) and software CD (MLPN 46-00374). The dongle is used to emulate a serial port on the host PC that FocusBT can connect to. The dongle and associated drivers must be installed on the host PC prior to the flash upgrade process.

To upgrade the firmware in the MS1633:

1. Connect the USB Dongle to an available port on the host PC and establish a connection via *Bluetooth* technology to the scanner. When the scanner is successfully connected it will beep once and the blue LED will stop blinking.
 2. Start the MetroSet2 software.
 3. Click on the plus sign (+) next to *POS Scanners* to expand the supported scanner list.
 4. Choose the FocusBT from the list.
 5. Click on the Configure FocusBT Scanner button.
 6. Select the COM port that the scanner is connected to on the host system.
 7. Choose *Flash Utility* from the options list located on the left side of the screen.
 8. Click on the *Open File* button in the Flash Utility window.
 9. Locate and open the flash upgrade file supplied by Metrologic.
 10. Click on the *Flash Scanner* button to begin the flash upgrade.
 11. When the upgrade is complete, a "Scanner updated successfully" message will appear in the Flash Utility window. The scanner will reboot.
- ♦ Metrologic's customer service department can be reached at 1-800-ID-METRO or 1-800-436-3876.
- ♦♦ MetroSet2 is available for download, at no additional cost, from <http://www.metrologic.com/corporate/download>.

LIMITED WARRANTY

The MS1633 FocusBT™ scanners are manufactured by Metrologic at its Suzhou, China facility. The MS1633 FocusBT scanners have a two (2) year limited warranty from the date of manufacture and the MS1633 FocusBT battery packs have a one (1) year limited warranty from the date of manufacture. Metrologic warrants and represents that all MS1633 FocusBT scanners are free of all defects in material, workmanship and design, and have been produced and labeled in compliance with all applicable U.S. Federal, state and local laws, regulations and ordinances pertaining to their production and labeling.

This warranty is limited to repair, replacement of product or refund of product price at the sole discretion of Metrologic. Faulty equipment must be returned to one of the following Metrologic repair facilities: Blackwood, New Jersey, USA; Madrid, Spain; or Suzhou, China. To do this, contact the appropriate Metrologic Customer Service/Repair Department to obtain a Returned Material Authorization (RMA) number.

In the event that it is determined the equipment failure is covered under this warranty, Metrologic shall, at its sole option, repair the Product or replace the Product with a functionally equivalent unit and return such repaired or replaced Product without charge for service or return freight, whether distributor, dealer/reseller, or retail consumer, or refund an amount equal to the original purchase price.

This limited warranty does not extend to any Product which, in the sole judgment of Metrologic, has been subjected to abuse, misuse, neglect, improper installation, or accident, nor any damage due to use or misuse produced from integration of the Product into any mechanical, electrical or computer system. The warranty is void if: (i) the case of Product is opened by anyone other than Metrologic's repair department or authorized repair centers; or (ii) any software is installed on the Product other than a software program approved by Metrologic.

THIS LIMITED WARRANTY, EXCEPT AS TO TITLE, IS IN LIEU OF ALL OTHER WARRANTIES OR GUARANTEES, EITHER EXPRESS OR IMPLIED, AND SPECIFICALLY EXCLUDES, WITHOUT LIMITATION, WARRANTIES OF MERCHANTABILITY AND FITNESS FOR A PARTICULAR PURPOSE UNDER THE UNIFORM COMMERCIAL CODE, OR ARISING OUT OF CUSTOM OR CONDUCT. THE RIGHTS AND REMEDIES PROVIDED HEREIN ARE EXCLUSIVE AND IN LIEU OF ANY OTHER RIGHTS OR REMEDIES. IN NO EVENT SHALL METROLOGIC BE LIABLE FOR ANY INDIRECT OR CONSEQUENTIAL DAMAGES, INCIDENTAL DAMAGES, DAMAGES TO PERSON OR PROPERTY, OR EFFECT ON BUSINESS OR PROPERTY, OR OTHER DAMAGES OR EXPENSES DUE DIRECTLY OR INDIRECTLY TO THE PRODUCT, EXCEPT AS STATED IN THIS WARRANTY. IN NO EVENT SHALL ANY LIABILITY OF METROLOGIC EXCEED THE ACTUAL AMOUNT PAID TO METROLOGIC FOR THE PRODUCT. METROLOGIC RESERVES THE RIGHT TO MAKE ANY CHANGES TO THE PRODUCT DESCRIBED HEREIN.

CORPORATE HEADQUARTERS, NORTH AMERICA

Metrologic Instruments, Inc.

90 Coles Rd.
Blackwood, NJ 08012-4683
Customer Service Department
Tel: 1-800-ID-METRO
Fax: 856-228-6673
Email: info@metrologic.com

METROLOGIC EUROPEAN REPAIR CENTER (MERC)

Metrologic Eria Ibérica, SL

C/Alfonso Gomez, 38-40, 1D
28037 Madrid
Tel: +34 913 751 249
Fax: +34 913 270 437

MTLG AUTO ID INSTRUMENTS (SHANGHAI) CO., LTD Suzhou Sales Office

BLK A, Room# 03/03-04
No.5 Xinghan Street, Xinsu Industrial Square
China-Singapore Suahou Industrial Park, Suzhou, PRC
Tel: 86-512-67622550
Fax: 86-512-67622560
Email: info@cn.metrologic.com

Safety

ITE Equipment

IEC 60950-1, EN 60950-1

LED

Class 1 LED Product: IEC 60825-1:1993+A1+A2,
EN 60825-1:1994+A1+A2



Caution

Use of controls or adjustments or performance of procedures other than those specified herein may result in hazardous radiation exposure. Under no circumstances should the customer attempt to service the LED scanner. Never attempt to look at the LED beam, even if the scanner appears to be nonfunctional. Never open the scanner in an attempt to look into the device. Doing so could result in hazardous radiation exposure. The use of optical instruments with the LED equipment will increase eye hazard.

Atención

La modificación de los procedimientos, o la utilización de controles o ajustes distintos de los especificados aquí, pueden provocar una exposición de luz brillante peligrosa. Bajo ninguna circunstancia el usuario deberá realizar el mantenimiento del LED (Diodo Emisor de Luz) del lector. Ni intentar mirar al haz del LED incluso cuando este no esté operativo. Tampoco deberá abrir el lector para examinar el aparato. El hacerlo puede conllevar una exposición peligrosa a la luz del LED. El uso de instrumentos ópticos con el equipo LED puede incrementar el riesgo para la vista.

Attention

L'emploi de commandes, réglages ou procédés autres que ceux décrits ici peut entraîner de graves irradiations. Le client ne doit en aucun cas essayer d'entretenir lui-même le scanner ou la LED. Ne regardez jamais directement le rayon LED, même si vous croyez que le scanner est inactif. N'ouvrez jamais le scanner pour regarder dans l'appareil. Ce faisant, vous vous exposez à un risque d'irradiation. L'emploi d'appareils optiques avec cet équipement à LED augmente le risque d'endommagement de la vision.

Achtung

Die Verwendung anderer als der hier beschriebenen Steuerungen, Einstellungen oder Verfahren kann eine gefährliche Licht emittierender Dioden strahlung hervorrufen. Der Kunde sollte unter keinen Umständen versuchen, den Licht emittierender Dioden-Scanner selbst zu warten. Sehen Sie niemals in den Licht emittierender Diodenstrahl, selbst wenn Sie glauben, daß der Scanner nicht aktiv ist. Öffnen Sie niemals den Scanner, um in das Gerät hineinzusehen. Wenn Sie dies tun, können Sie sich einer gefährlichen Licht emittierender Diodenstrahlung aussetzen. Der Einsatz optischer Geräte mit dieser Laserausrüstung erhöht das Risiko einer Sehschädigung.

Attenzione

L'utilizzo di sistemi di controllo, di regolazioni o di procedimenti diversi da quelli descritti nel presente Manuale può provocare delle rischiose esposizioni radiattive. Il cliente non deve assolutamente tentare di riparare egli stesso lo scanner LED (o diodo emettitore di luce). Non guardate mai il raggio LED (d. emettitore di luce), anche se credete che lo scanner non sia attivo. Non aprite mai lo scanner per guardare dentro l'apparecchio. Facendolo potete esporvi ad una radiazione rischiosa. L'uso di apparecchi ottici, equipaggiati con raggi LED (d. emettitori di luce), aumenta il rischio di danni alla vista.

EMC

Emissions

FCC Part 15, ICES-003, CISPR 22, EN 55022, EN300 328 V1.6.1, EN301 489-17 V1.2.1

Immunity

CISPR 24, EN 55024

Changes or modifications not expressly approved by the party responsible for compliance could void the user's authority to operate the equipment.

Class B Devices

This device complies with Part 15 of the FCC Rules. Operation is subject to the following two conditions: (1) This device may not cause harmful interference, and (2) this device must accept any interference received, including interference that may cause undesired operation.

This equipment has been tested and found to comply with the limits for a Class B digital device, pursuant to Part 15 of the FCC rules. These limits are designed to provide reasonable protection against harmful interference in a residential installation. This equipment generates, uses and can radiate radio frequency energy and, if not installed and used in accordance with the instructions, may cause harmful interference to radio communications. However, there is no guarantee that interference will not occur in a particular installation. If this equipment does cause harmful interference to radio or television reception, which can be determined by turning the equipment off and on, the user is encouraged to try to correct the interference by one or more of the following measures:

- Reorient or relocate the receiving antenna
- Increase the separation between the equipment and receiver
- Connect the equipment into an outlet on a circuit different from that to which the receiver is connected
- Consult the dealer or an experienced radio/TV technician for help

Notice

This Class B digital apparatus complies with Canadian ICES-003.

Remarque

Cet appareil numérique de classe B est conforme à la norme canadienne NMB-003.

Exposure to Radio Frequency Energy

The radiated output power of this intentional wireless radio is far below the FCC radio frequency exposure limits. The internal wireless radio operates within guidelines found in radio frequency safety standards and recommendations, which reflect the consensus of the scientific community. The level of energy emitted is far less than the electromagnetic energy emitted by wireless devices such as mobile phones. However, the use of wireless radios may be restricted in some situations or environments, such as aboard airplanes. If you are unsure of restrictions, you are encouraged to ask for authorization before turning on the wireless radio.

For more information from the US FCC about exposure to RF energy, see:
www.fcc.gov/oet/rfsafety

For information about the scientific research related to RF energy exposure, see the EMF Research Database maintained by the World Health Organization at:
www.who.int/emf

PATENTS

This METROLOGIC product may be covered by, but not limited to, one or more of the following U.S. Patents:

U.S. Patent No.; 7,086,595; 7,128,266; 7,213,762; 7,216,810; 7,225,988; 7,225,989; 7,237,722; 7,240,844; 7,240,844; 7,243,847; 7,255,279; 7,267,282; 7,270,272; 7,273,180; 7,278,575; 7,281,661; 7,284,705; 7,293,714; 7,299,986; 7,320,431; 7,325,738

No license right or sublicense is granted, either expressly or by implication, estoppel, or otherwise, under any METROLOGIC or third party intellectual property rights (whether or not such third party rights are licensed to METROLOGIC), including any third party patent listed above, except for an implied license only for the normal intended use of the specific equipment, circuits, and devices represented by or contained in the METROLOGIC products that are physically transferred to the user, and only to the extent of METROLOGIC'S license rights and subject to any conditions, covenants and restrictions therein.

Other worldwide patents pending.

INDEX

A

AC 2, 38
Accessories 2
Adapter 2, 10–12
Address 18
Aperture 3
Audible Indicator 27–28

B

Bar Code 33–36, 37, 41
Bar Code Element 30
Battery 6–9
Beep 9, 27–28, 33–36, 37, *see indicators*
Blue LED 3, 6, 27–28, 43

C

Cable
 Communication 43
Caution 46–48
CE 4
Charge *See Battery*
Class 47
Client 18
Communication Parameters .. 39–40
Compliance 44, 46–48
Configuration... 2, 15–16, 33–36, 41
Cradle 20
Current 38
Customer Service 2, 44

D

DC 2, 38
Decode 37
Default Parameters 39–40
Depth of Field 30
Driver 10–16

E

EMC 38

F

Firmware 43

FirstFlash 1
Flash ROM 43

I

Indicator
 Audible 3, 9, 27–28, 37, 43
 Failure 3, 27–28
 Visual 3, 6, 27–28, 37, 43
Inventory 21
IR 1, 25, 32

L

Labels 4
LED 33–36, 37, 46–48
 Blue 6, 27–28
 White 6, 27–28
 Yellow 27–28
Light Levels 38
Light Source 37

M

Maintenance 5
Meteor 41
MetroSelect 26, 41
MetroSet2 41
Mode of Operation 25

N

Notices 47

P

Patent 49
Pin 17
Power 38, 41, 43
Presentation 25
Product Safety 46–48

R

Radio Frequency 48
RangeGate 1, 20
Razz 27–28, 33–36
Reconnect 13–14
Repair 44
RMA 44

INDEX

S

Server	16
Service	39
Specifications	
Electrical	34
Environmental	34
Mechanical	33
Operational	33
Stand	2, 20–22, 20–22, 23

T

Tone	25–26
Alternate	24
Transformer	2, 34
Trigger	3
Troubleshooting	29–32

U

UL	4
Upgrade	38
Utility	12–13

V

Ventilation	34
Visual Indicator	25–26
Voltage	34

W

Warranty	39
White LED	3, 6, 25–26
Window	3, 5

Y

Yellow LED	3, 25–26
------------------	----------

WORLDWIDE HEADQUARTERS

Metrologic Instruments, Inc.

90 Coles Rd. Blackwood, NJ 08012-4683 • Email: info@metrologic.com

CUSTOMER SERVICE TEL: 1-800-ID-METRO • Corporate Tel: 856-228-8100

Fax: 856-228-6673 (Sales) • 856-228-1879 (Marketing) • Fax: 856-228-0653 (Legal/Finance)

METROLOGIC - THE AMERICAS

USA

Metrologic USA - Headquarters

Tel: 1.856.537.6400

Fax: 1.856.537.6474

Email: info@us.metrologic.com

Mexico

Metrologic Mexico, S.A. DE C.V.

Tel: 55.5365.6247

Fax: 55.5362.2544

Email: info@mx.metrologic.com

South America

Metrologic do Brasil Ltda.

Tel: 52.55.11.5182.7273

Fax: 52.55.11.5182.7198

Email: info@sa.metrologic.com

South America

Metrologic South America

Tel: 1.239.642.1958

Fax: 1.239.642.1959

Email: info@sa.metrologic.com

OMNIPLANAR

USA

Tel: 856.374.5550

Fax: 856.374.5576

Email: info@omniplanar.com

NOVODISPLAY

USA

Tel: 856.537.6139

Fax: 856.537.6116

Email: info@NOVODisplay.com

METROLOGIC - EMEA

Central Europe

Metrologic Instruments GmbH

Headquarters

Tel: 49-89-89019-0

Fax: 49-89-89019-200

Email: info@de.metrologic.com

France

Metrologic Eria France SA

Tel: +33 (0) 1 48.63.78.78

Fax: +33 (0) 1 48.63.24.94

Email: info@fr.metrologic.com

METROLOGIC - EMEA

Spain

Metrologic Eria Iberica, SL

Tel: +34 913 272 400

Fax: +34 913 273 829

Email: info@es.metrologic.com

Russia

Metrologic Instruments LLC

Tel: +7 (495) 737 7273

Fax: +7 (495) 737 7271

Email: info@ru.metrologic.com

Italy

Metrologic Instruments Italia

Tel: +39 0 57 6511978 or

+39 051 651 1978

Fax: +39 0 51 6521337

Email: info@it.metrologic.com

Poland

Metrologic Instruments

Poland

Tel: +48 (22) 545 04 30

Fax: +48 (22) 545 04 31

Email: info@pl.metrologic.com

United Kingdom

Metrologic Instruments

UK Limited

Tel: +44 (0) 1256 365900

Fax: +44 (0) 1256 365955

Email: info@uk.metrologic.com

METROLOGIC - APAC

Asia

Metrologic Asia (Pte) Ltd

Headquarters

Tel: (65) 6842-7155

Fax: (65) 6842-7166

Email: info@sg.metrologic.com

China

Suzhou Sales Office

Headquarters

Tel: 86-512-67622550

Fax: 86-512-67622560

Email: info@cn.metrologic.com

China

Beijing Sales Office

Tel/Fax: 86 10 82253472

Email: info@cn.metrologic.com

METROLOGIC - APAC

China

Chengdu Sales Office

Tel/Fax: 86 28 86200109

Email: info@cn.metrologic.com

China

Guangzhou Sales Office

Tel: 86-20-38823476

Fax: 86-20-38823477

Email: info@cn.metrologic.com

India

India Sales Office

Tel: +91 80 41256718

Fax: +91 80 41256719

Email: info@in.metrologic.com

Korea

Korea Sales Office

Tel: 82-2-6205-5379

Fax: 82-2-3444-3980

Email:

Scott.lee@kr.metrologic.com

Japan

Metrologic Japan Co., Ltd.

Tel: 81-3-3839-8511

Fax: 81-3-3839-8519

Email: info@jp.metrologic.com

Thailand

Metrologic Thailand

Tel: +662-610-3787

Fax: +662-610-3601

Email:

tawan.jandang@th.metrologic.com

China

Shanghai

Tel: 86-21-58356616

Fax: 86-21-58358873

Email: info@cn.metrologic.com

Australia

Metrologic Australia

Tel: 61 2 9652 2726

(international)

Tel: 02 9816 6470 (local)

Tel: 1 800 99 88 38 (Australia)

Email:

kmason@au.metrologic.com

September 2008



00 - 02280E