

MMF Cash Drawer Multi-Serial Interface

Multi-Serial Interface Operator's Manual

June 22, 2004



MMF Cash Drawer Co.
370 Alice St., Wheeling, IL. 60090-5891
Phone: 800 769-1954

MMF Multi-Serial Interface

INTRODUCTION

The MMF Multi-Serial Interface enables the cash drawer to be controlled by a serial RS-232 output port in the following configurations:

- Standard serial dedicated; one cash drawer connected to the PC serial port.
- Serial non-dedicated or daisy chain mode; two cash drawers can be connected to the same serial port or a serial peripheral can be connected to the cash drawer using the same serial port.

With both the serial non-dedicated and serial dedicated configurations it is possible to select via DIP switches the following options:

- ⇒ Select a specific or random character to open the cash drawer.
- ⇒ Configure RS-232 settings.
- ⇒ Select the open/close drawer status signal for each cash drawer
- ⇒ Compatible with 12VDC powered serial ports.

SETTING UP THE CASH DRAWER

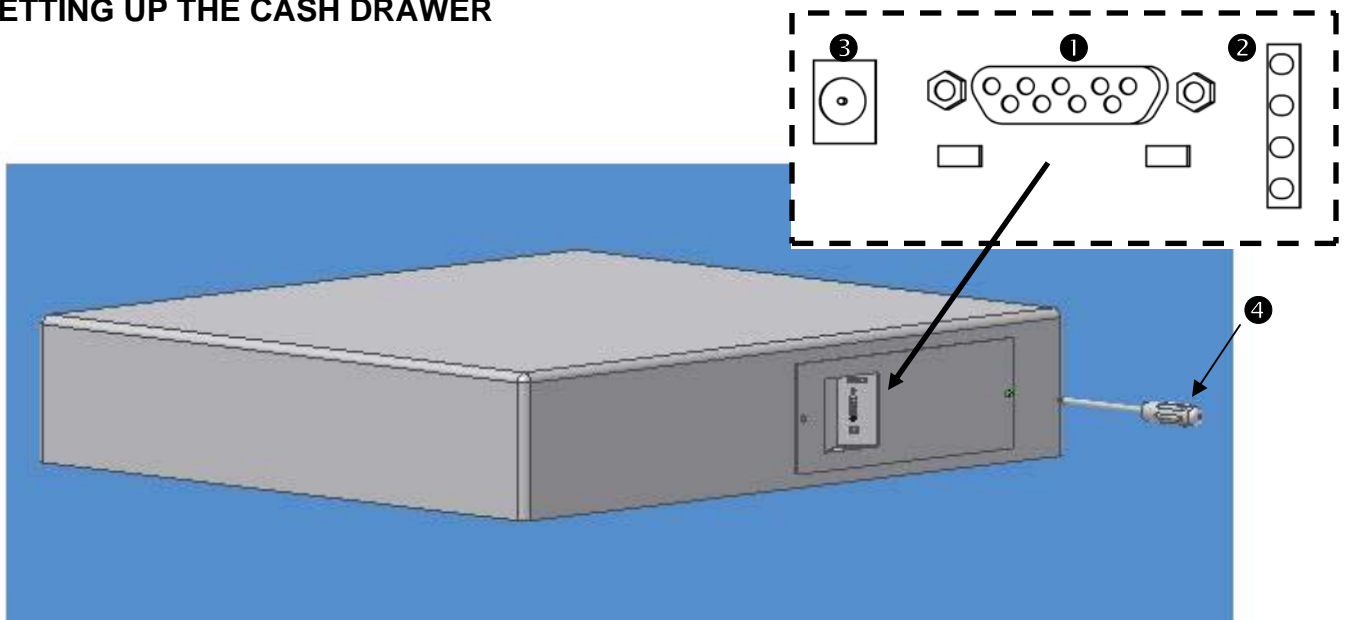

Figure 1

1 RS-232 serial connection

Provides a programmable RS-232 connection to the RS-232 serial port of a host device like a computer or terminal.

Optional cash drawer serial cables and adaptors:

- ⇒ P/N: 2261 99SD9F06 00 -Serial cable DB-9 female to DB-9 male.
- ⇒ P/N: 2261 99ND9F06 00 -Serial Daisy-Chain or Non-Dedicated DB-9 female to DB-9 male and DB-9 male.
- ⇒ P/N: 2261 99DB9250 00 -Serial Adaptor to convert a DB-9 Male to a DB-25 Female.

PIN 1:	DCD - Data Carrier Detect
PIN 2:	RxD - Receive Data
PIN 3:	TxD - Transmit Data
PIN 4:	DTR - Data Terminal Ready
PIN 5:	GND - Signal Ground
PIN 6:	DSR - Data Set Ready
PIN 7:	RTS - Request to Send
PIN 8:	CTS - Clear to Send
PIN 9:	RI - Ring Indicator

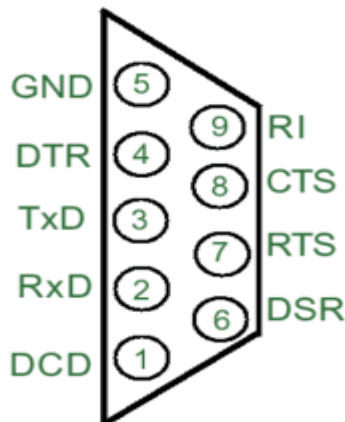

② LED Signal Status Panel

- **LED #4** (top-red) DTR / DSR / DCD Status; LED is ON when there is activity on any of these lines
- **LED #3** (red) RTS / CTS Status; LED is ON when there is activity on any of these lines
- **LED #2** (red) Drawer Status. Open / Close inner drawer indicator.
- **LED #1** (green) Power good when ON solid / Data received when blinking

③ Supply Voltage

+12 VDC γ 5% 0.8 A.

Plug required for Power connector:

OD: 5.5mm γ 0.1mm

ID: 2.1 mm γ 0.1mm

Length: 8.75 mm γ 0.5mm

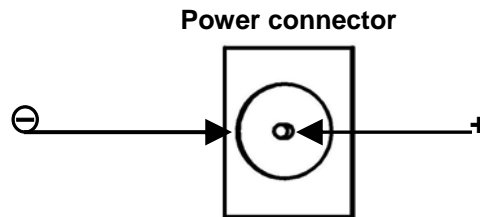

④ DIP Switch settings

To modify the cash drawer settings locate the serial interface module plate on the back of the cash drawer as shown on **Figure 1**, remove the two side screws to access the serial PC board and locate the three banks of DIP switches SW1, SW2 and SW3 as shown in **Figure 2**.

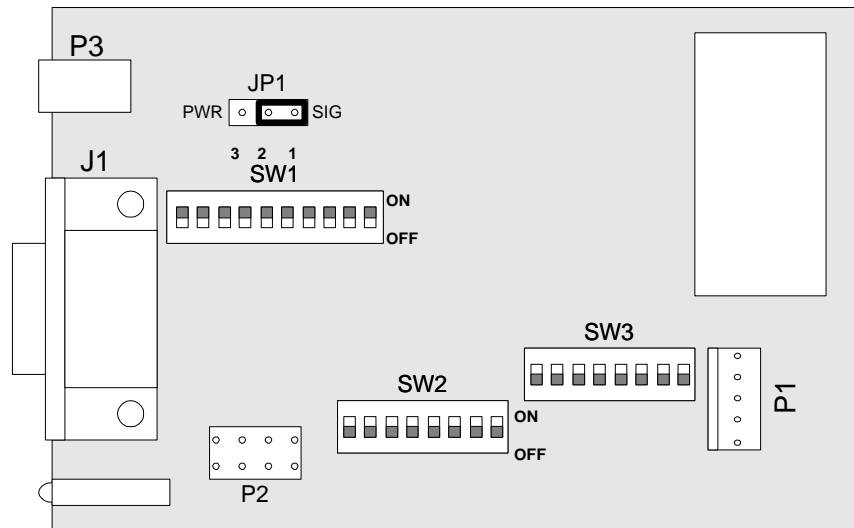

Figure 2

Switch 1

When the indicated Switch is ON, all other specified Switches in the same column must be OFF

POS	SW1	SW1 CONFIGURATION CONSTRAINTS									
	FUNCTION (when ON)	1	2	3	4	5	6	7	8	9	10
1	Loop DTR (pin 4) to DCD (pin 1)	ON	OFF								
2	Loop DTR (pin 4) to DSR (pin 6)	OFF	ON							OFF	
3	Loop CTS (pin 8) to RTS (pin 7)			ON			OFF	OFF			
4	Receive Drawer-Open data input on TXD (pin 3)				ON	OFF	OFF				OFF
5	Receive Drawer-Open data input on RXD (pin 2)				OFF	ON	OFF				
6	Receive Drawer-Open data input on CTS (pin 8)			OFF	OFF	OFF	ON	OFF			
7	Send Drawer-Status output on CTS (pin 8)			OFF			OFF	ON	OFF	OFF	
8	Send Drawer-Status output on RI (pin 9) - <i>see JP1</i>							OFF	ON	OFF	
9	Send Drawer-Status output on DSR (pin 6)		OFF					OFF	OFF	ON	
10	Re-Transmit Drawer-Open data signal on TXD (pin 3)				OFF						ON

JP1 when SW1-pos 8 is in the ON position, jumper JP1 must be placed in the SIG position (jumper across pins 1 and 2 of JP1).

JP1 must be placed on the PWR position (jumper across pins 3 and 2 of JP1) when receiving power via pin 9 from a PC powered serial port.

Switch 2

SW2 Functions only apply when the controller is set to "Smart Mode" (SW3-1 = ON)

POS	SW2
	FUNCTION
1	ASCII Character Bit 0 (LSB)
2	ASCII Character Bit 1
3	ASCII Character Bit 2
4	ASCII Character Bit 3
5	ASCII Character Bit 4
6	ASCII Character Bit 5
7	ASCII Character Bit 6 (MSB)
8	Number of Data Bits (OFF = 7 Bits, ON = 8 Bits)

See CHART #1 for complete table of ASCII characters and settings for SW2.

Switch 3

"Dumb Mode" any open character based on the number of pulses within that ASCII character will open the cash drawer.

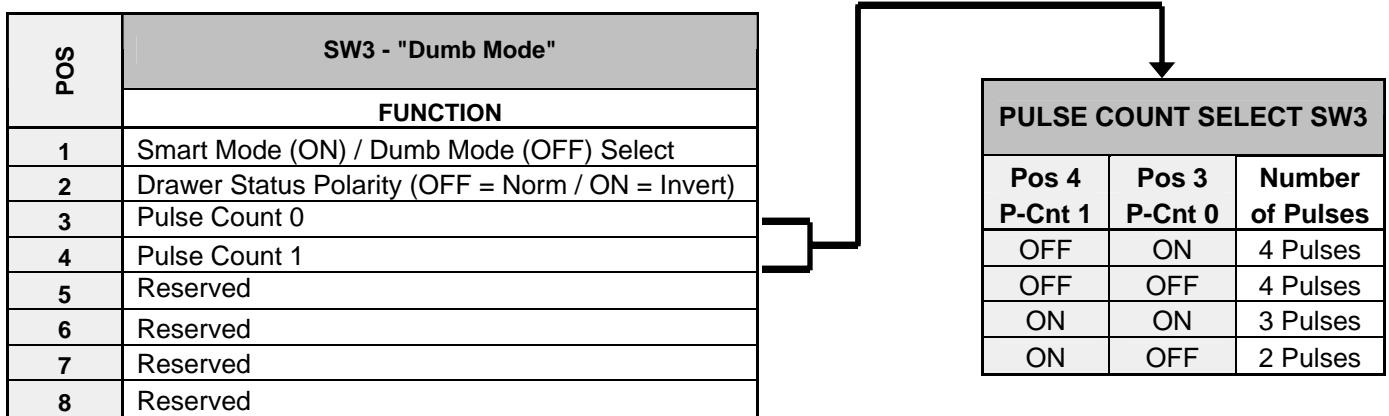

The above SW3 Functions only apply when the controller is set to "Dumb Mode" (SW3-1 = OFF)

"Smart Mode" open character and RS-232 settings are pre-selected.

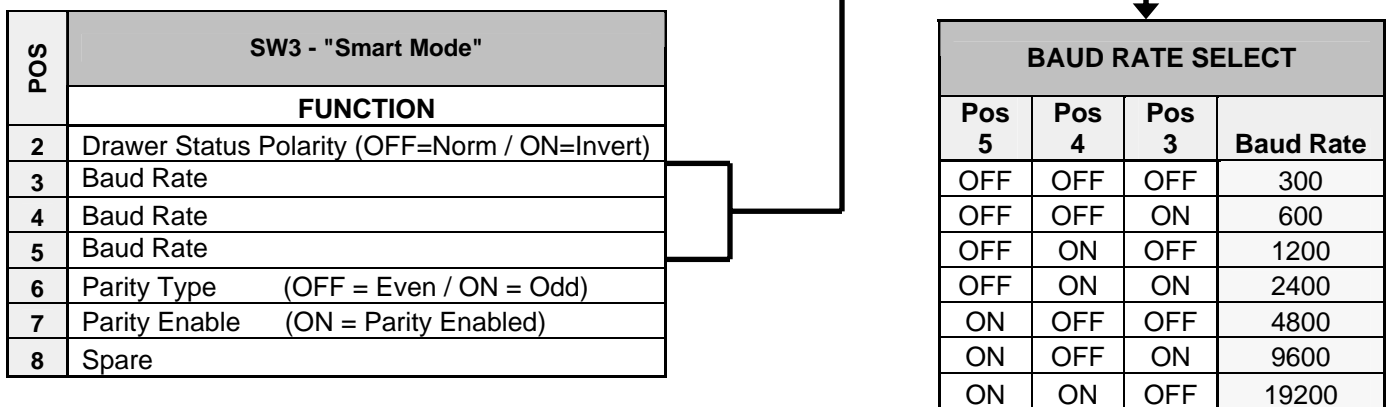

The above SW3 Functions only apply when the controller is set to "Smart Mode" (SW3-1 = ON)

Parity / 7 Data Bits Note: When the number of data bits is set to 7 (SW2-8 = OFF) parity must be Enabled (SW3-7 = ON). Setting the number of data bits to 7 while parity is disabled will result in an invalid mode. If the controller is set to this mode, LED #1 (green) and LED #2 (red) will blink to indicate the invalid condition.

CONFIGURATION EXAMPLES

Factory Default –*This standard configuration* is set so that any one (1) ASCII character will open the cash drawer and the RS-232 settings are auto-detected automatically by the cash drawer.

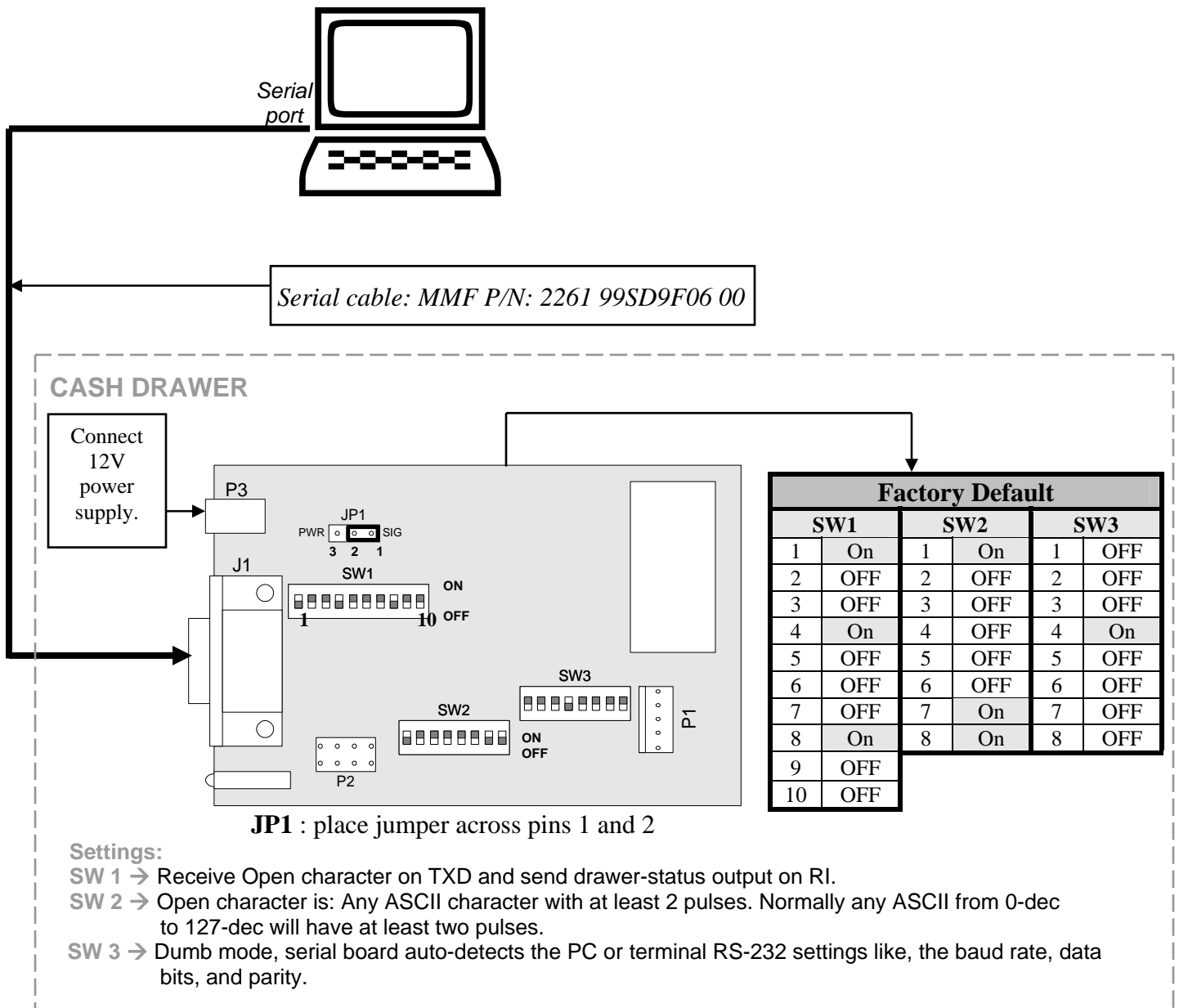

TEST PROCEDURE

Factory Default – Any ASCII character will open drawer and RS-232 settings are auto-detected automatically by the cash drawer.

Test from DOS:

1.- Configure the COM port settings
by typing:

MODE com1:9600,n,8,1

The computer should
return the following

2.- To test the cash drawer type:

copy con com1: <enter>

A <enter>

F6 <enter>

The drawer should open and the
PC will return the following

```
C:\Documents and Settings\testp>mode com1:9600,n,8,1

Status for device COM1:
-----
Baud:          9600
Parity:        None
Data Bits:     8
Stop Bits:     1
Timeout:       OFF
XON/XOFF:     OFF
CTS handshaking: OFF
DSR handshaking: OFF
DSR sensitivity: OFF
DTR circuit:  ON
RTS circuit:  ON

C:\Documents and Settings\testp>copy con com1:
AA
A
^Z
          1 file(s) copied.

C:\Documents and Settings\testp>
```

Test from Windows:

Factory Default – Any ASCII character will open drawer and RS-232 settings are auto-detected.

1.- INSTALL MMF OPOS DRIVER -V2.2, available under:

www.mmfcashdrawer.com / Tech Support / Drivers

i The user installing the MMF cash drawer software and configuring the cash drawer devices on Windows 2000 and Windows XP is required to have Administrator Rights. Once the software is installed, all users with normal rights can use it.

To install the driver run the file: Setup.exe. When the installation is complete, a start menu item under the 'Programs' folder will have entries for both the:

-Configure and Test

- OPOS Test

2.- Open the "Configure and Test" program and configure the screen with the following settings:

3.- Click on "Configure Device"

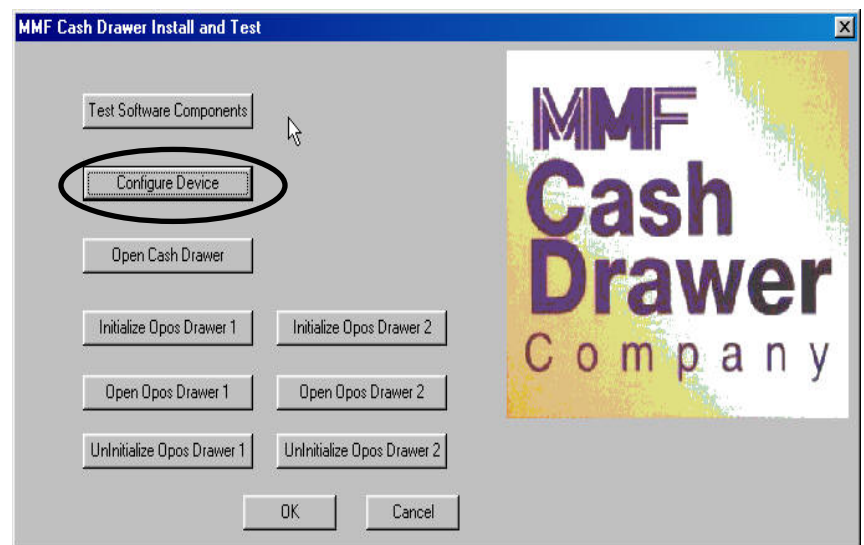

4.- CONFIGURE DRAWER

"Add new drawer" called *MMFSerial*

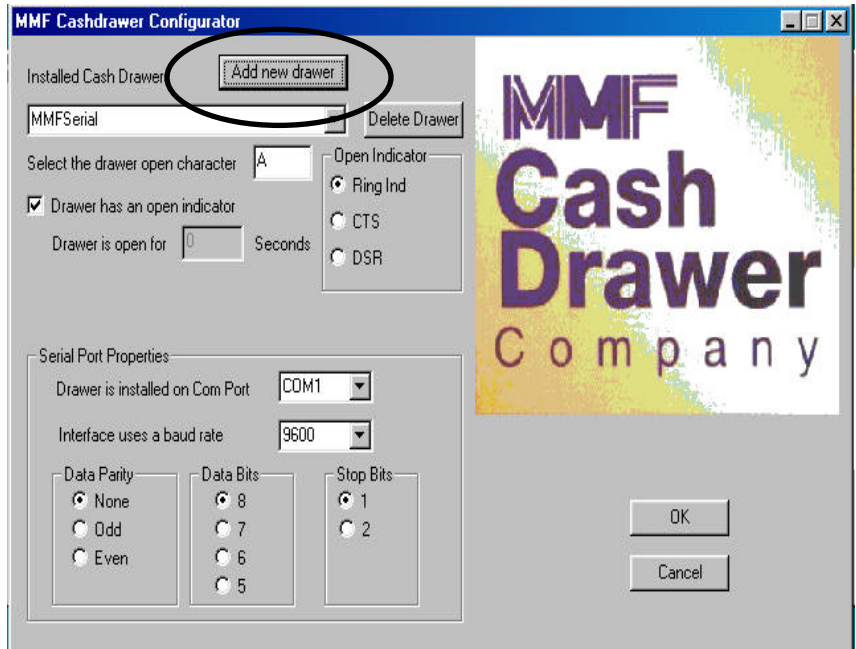

5.- Type all the settings as illustrated on the configuration screen and click "OK" to save settings

6.- TEST DRAWER

Click on "Initialize OPOS Drawer 1" then, click on "Open OPOS Drawer 1" the following message will be displayed:



7.- Click "OK" to the above message and then manually close the cash drawer. When the drawer is completely closed the following message will be displayed:

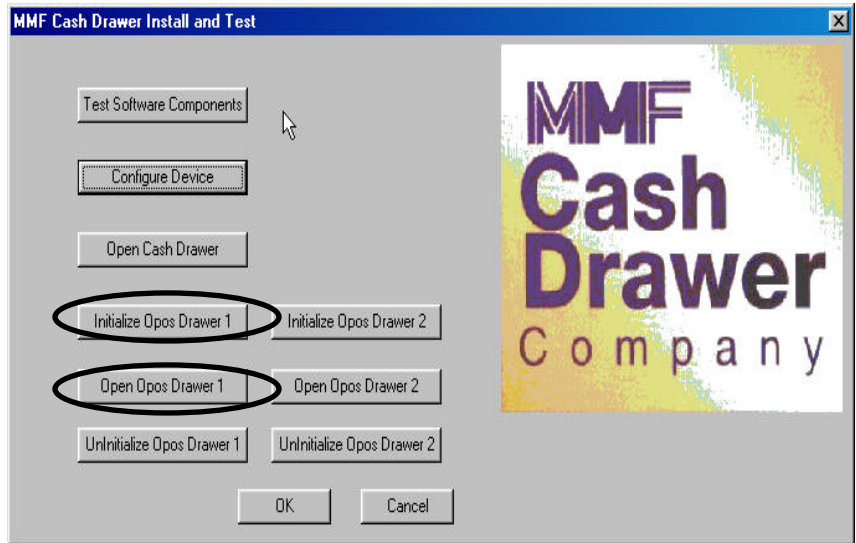

8.- Click on "Uninitialize OPOS Drawer 1" and the test is complete.

CONFIGURATION EXAMPLES

Daisy Chain two cash drawers –This serial non-dedicated configuration utilizes only one PC COM port to control two cash drawers. As a unique feature, each cash drawer can report the drawer Open / Close status independently.

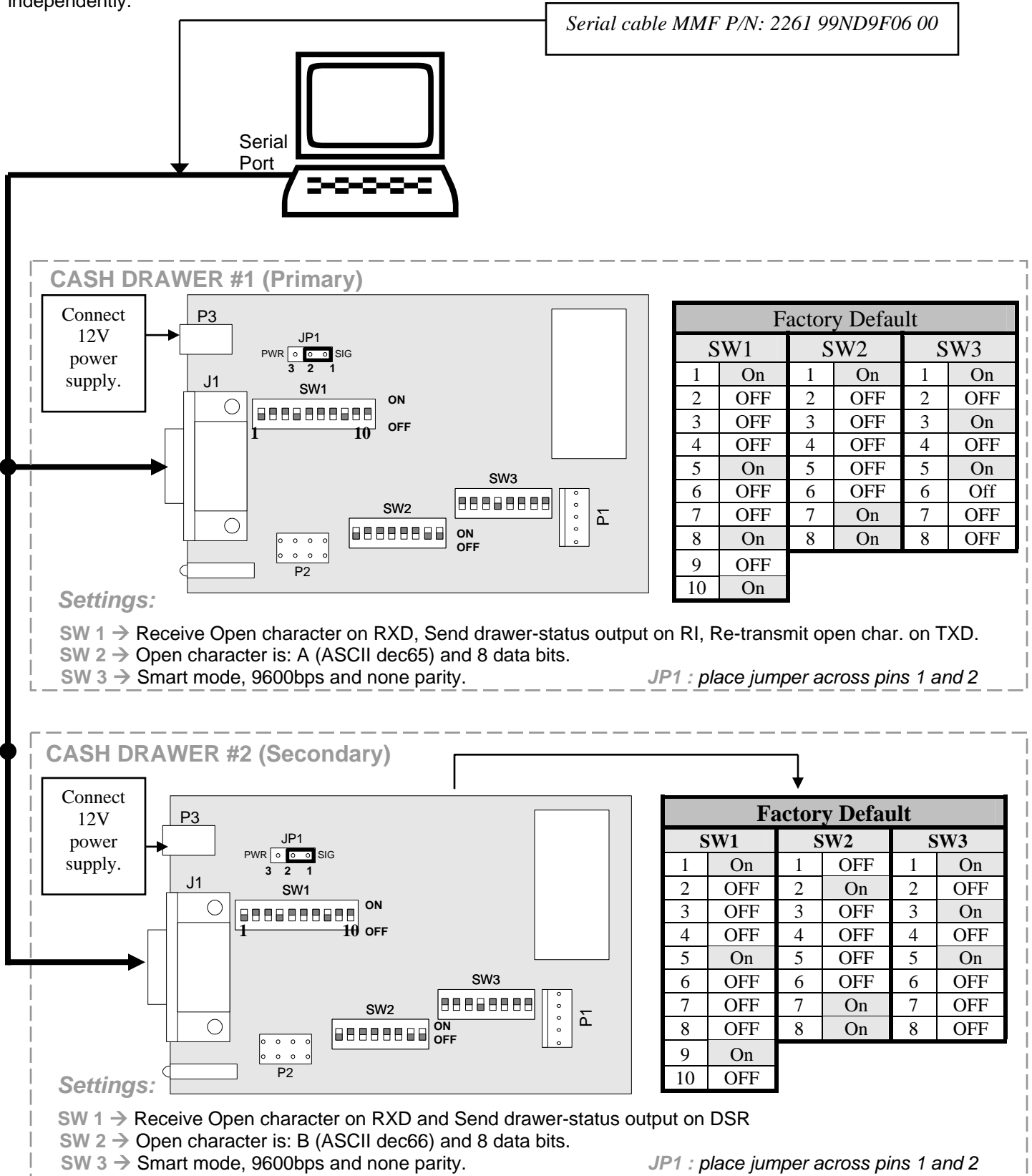

TEST PROCEDURE

Daisy Chain two cash drawers –This serial non-dedicated configuration utilizes only one PC COM port to control two cash drawers. As a unique feature, each cash drawer can report the drawer Open / Close status independently.

Test from DOS:

1.- Configure the COM port settings by typing:
MODE com1:9600,n,8,1

The computer should return the following

2.- To test the cash drawer type:
copy con com1: <enter>
A <enter>
F6 <enter>

The drawer should open and the PC will return the following

3.- To test Cash Drawer #2 type:
copy con com1: <enter>
B <enter>
F6 <enter>

```
C:\Documents and Settings\testp>mode com1:9600,n,8,1
Status for device COM1:
-----
Baud:          9600
Parity:        None
Data Bits:     8
Stop Bits:     1
Timeout:       OFF
XON/XOFF:      OFF
CTS handshaking: OFF
DSR handshaking: OFF
DSR sensitivity: OFF
DTR circuit:   ON
RTS circuit:   ON

C:\Documents and Settings\testp>copy con com1:
AA
^Z

1 file(s) copied.

C:\Documents and Settings\testp>
```

Test from Windows: Daisy Chain two cash drawers

1.- **INSTALL MMF OPOS DRIVER -V2.2**, available under:
www.mmfcashdrawer.com / Tech Support / Drivers

ⓘ The user installing the MMF cash drawer software and configuring the cash drawer devices on Windows 2000 and Windows XP is required to have Administrator Rights. Once the software is installed, all users with normal rights can use it.

To install the driver run the file: Setup.exe. When the installation is complete, a start menu item under the 'Programs' folder will have entries for both the:

- Configure and Test
- OPOS Test

2.- Open the "Configure and Test" program and configure the screen with the following settings:

3.- Click on "Configure Device"

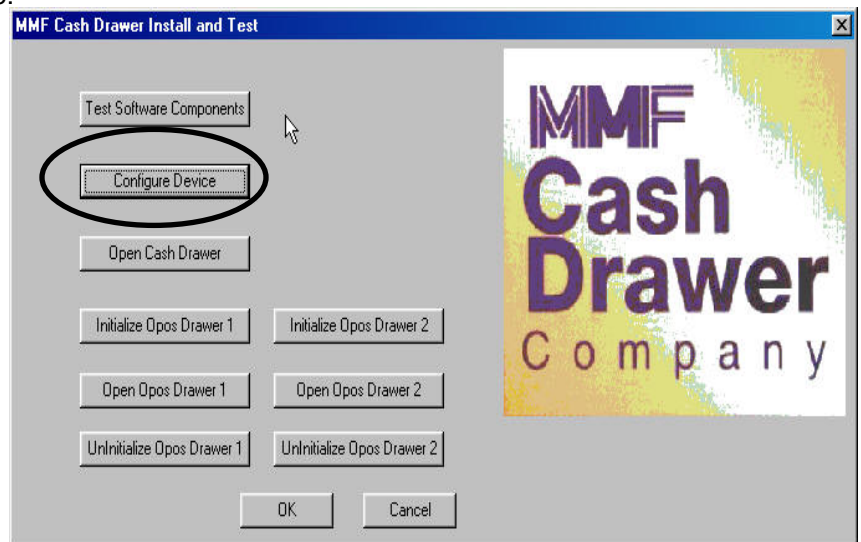

4.- CONFIGURE DRAWER #1- To add the first device click on “Add new drawer” called: Cash_Drawer#1. Select “Serial Composite device” for dual cash drawer configuration.

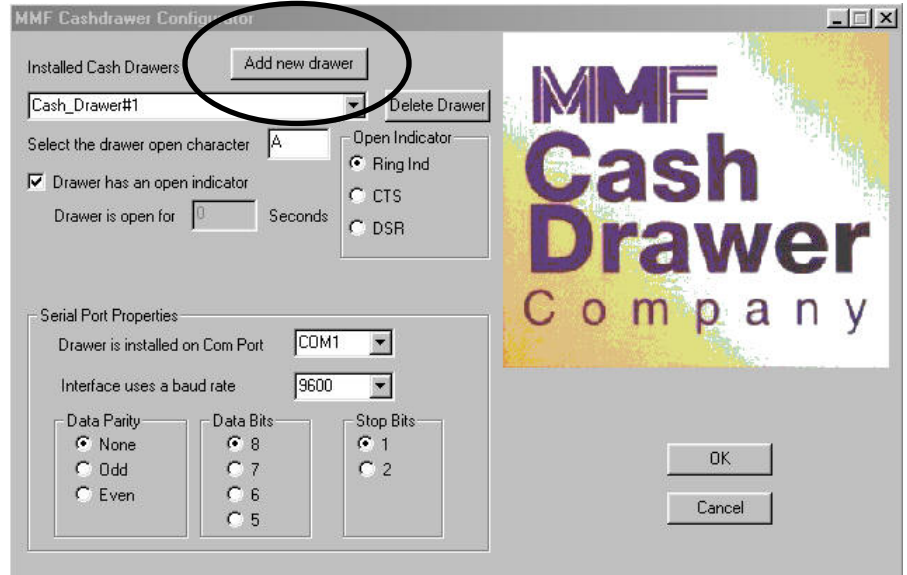

5.- Type all the settings as illustrated on the configuration screen and click “OK” to save settings

6.- CONFIGURE DRAWER #2- To add the second device click on “Add new drawer” called: **Cash_Drawer#2**. Select “Serial Composite device” for dual cash drawer configuration.

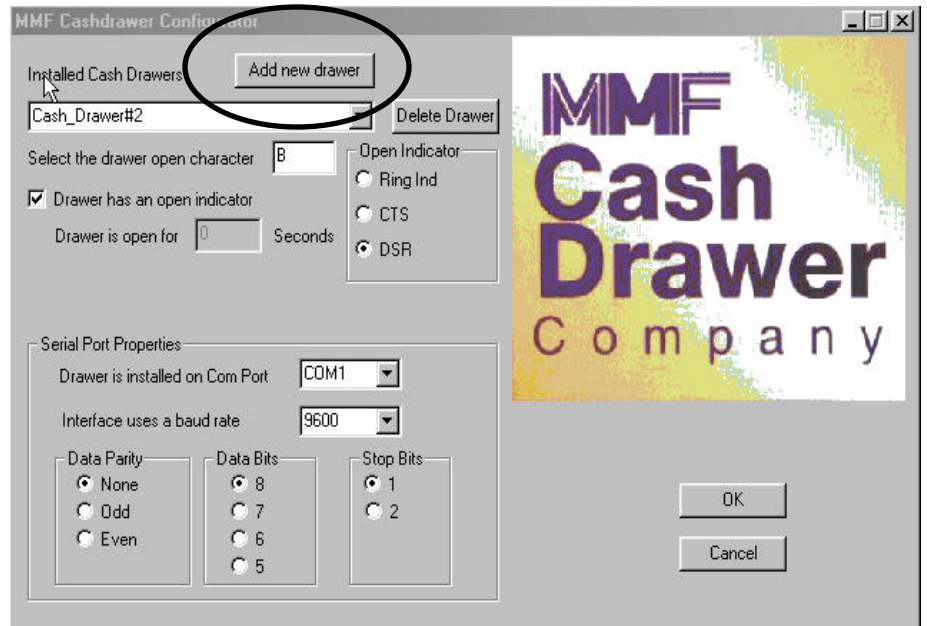

7.- Type all the settings as illustrated on the configuration screen and click “OK” to save settings

8.- TEST DRAWER #1-

Click on "Initialize OPOS Drawer 1" then, click on "Open OPOS Drawer 1" the following message will be displayed:

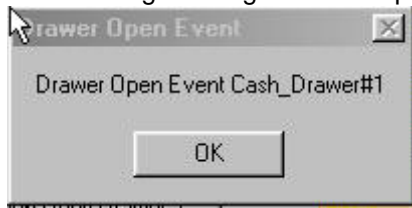

9.- Click "OK" to the above message and then manually close the cash drawer. When the drawer is completely closed the following message will be displayed:

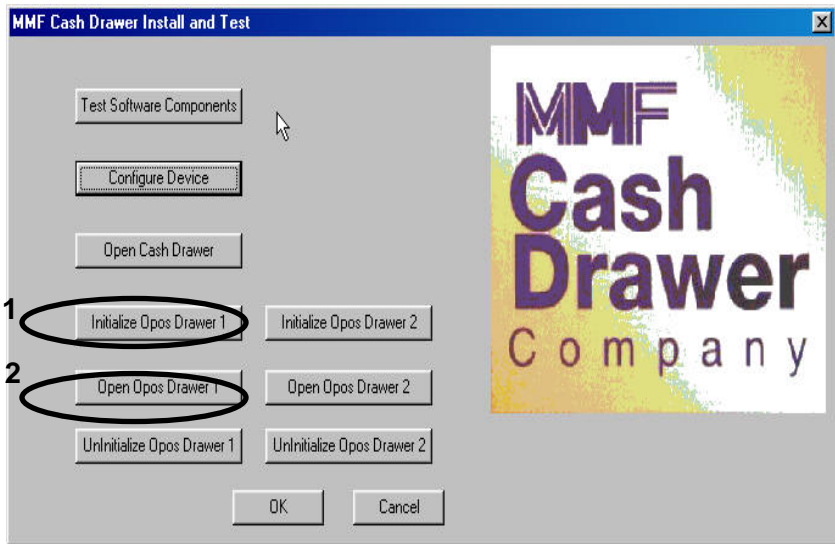
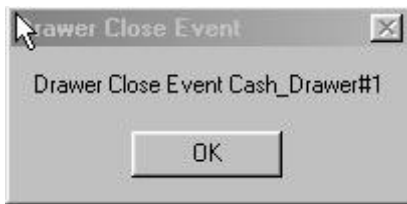

10.- Click on "Uninitialize OPOS Drawer 1" and the test is complete.

11.- TEST DRAWER #2- Click on "Initialize OPOS Drawer 2" then, click on "Open OPOS Drawer 2" the following message will be displayed:

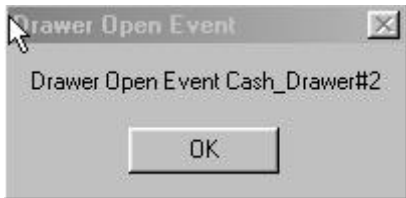

12.- Click "OK" to the above message and then manually close the cash drawer. When the drawer is completely closed the following message will be displayed:

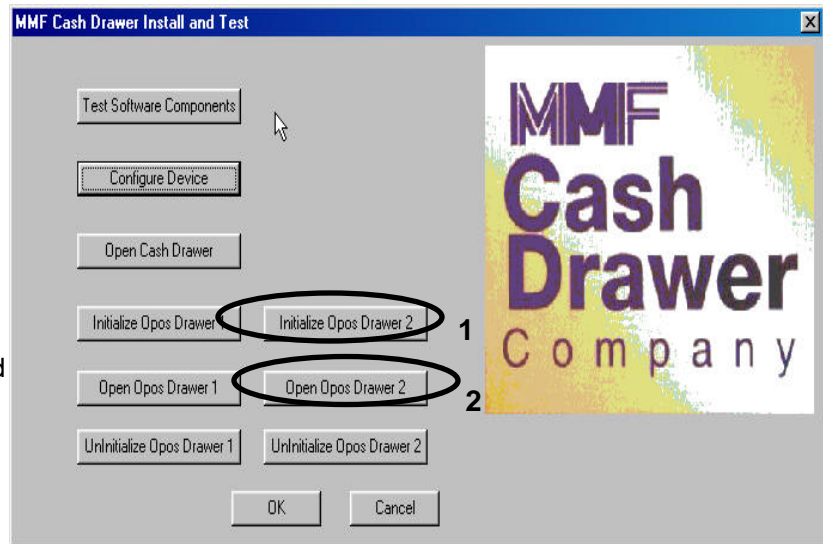
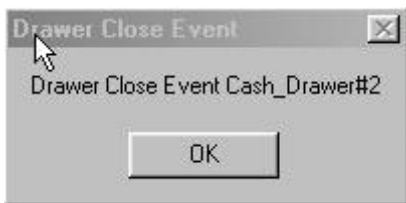

13.- Click on "Uninitialize OPOS Drawer 2" and the test is complete.

CONFIGURATION EXAMPLES

Interfacing with powered serial ports – The Multi-serial interface has the ability to receive power from the host and avoid using an external power supply for the cash drawer. This is only possible if the host has a powered serial port with the ability to supply 12VDC 800mA on pin#9.

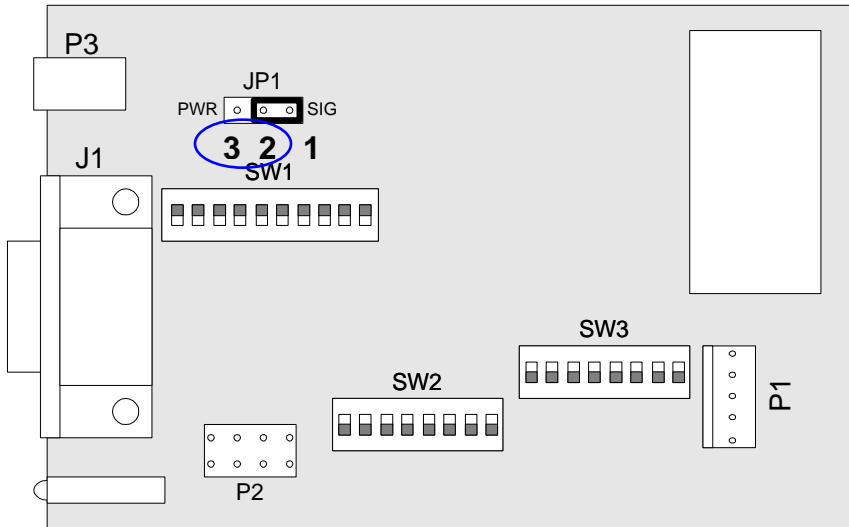

➤ **JP1** must be placed on the PWR position (jumper across pins 3 and 2 of JP1) when receiving power via pin 9 from a PC powered serial port.

➤ Power will be received on Pin#9 Ring Indicator (RI), for this reason a different signal must be selected to send the drawer open/close status, for which CTS or DRS are available and can be selected on SW1.