

PA600 Rugged Enterprise PDA

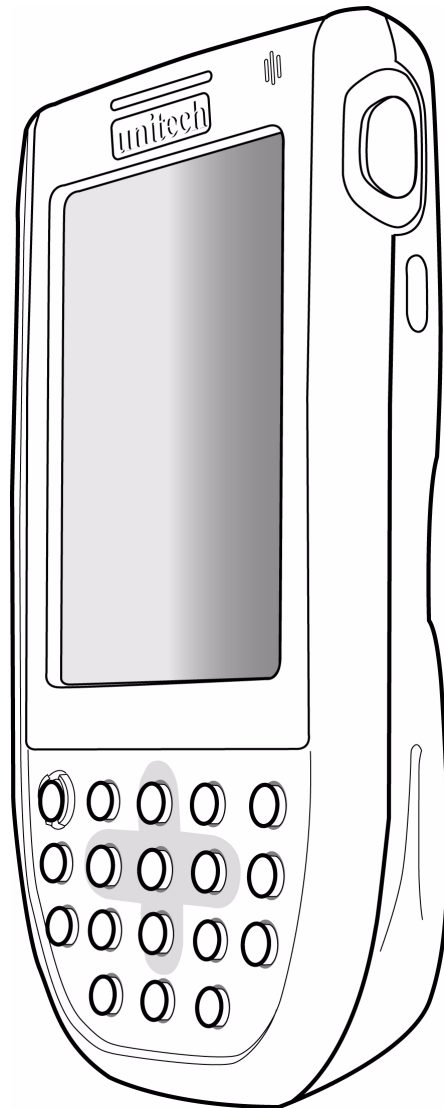

User's Manual

400546G Rev. D



About This Manual

This manual explains how to install, operate and maintain the PA600 PDA Barcode Scanner.

No part of this publication may be reproduced or used in any form, or by any electrical or mechanical means, without permission in writing from the manufacturer. This includes electronic or mechanical means, such as photocopying, recording, or information storage and retrieval systems. The material in this manual is subject to change without notice.

© Copyright 2006 Unitech Electronics Co., Ltd. All rights reserved.

Bluetooth is a registered trademark of Bluetooth SIG. Microsoft, Windows and Active-Sync are either registered trademarks or trademarks of Microsoft Corporation. Other product names mentioned in this manual may be trademarks or registered trademarks of their respective companies and are hereby acknowledged.



unitech is a member of Oracle Embedded Software Licensing Program

Regulatory Compliance Statements

FCC Statement

This is a FCC Part 15 Class B product. In a domestic environment this product may cause radio interference, in which case the user may be required to take adequate measures.

Canadian Compliance Statement

This Class B Digital apparatus meets all requirements of the Canadian Interference-Causing Equipment Regulations.

Cet appareil numérique de la classe B respecte les exigences du Règlement sur le matériel brouilleur du Canada.

The device is certified to the requirements of RSS-139-1 for 2.4 GHz spread spectrum devices.

European Conformity Statement

Declaration of Conformity with Regard to the R&TTE 1999/5/EC and EMC 89/336/EEC directives.

Laser Information

The Unitech PA600 series is certified in the U.S. to conform to the requirements of DHHS/CDRH 21CFR Subchapter J and to the requirements of IEC 825-1. Class II and Class 2 products are not considered to be hazardous. The PA600 series contains internally a Visible Laser Diode (VLD) whose emissions do not exceed the maximum limits as set forth in the above regulations. The scanner is designed so that there is no human access to harmful laser light during normal operation, user maintenance or during prescribed service operations.

The laser safety warning label required by the DHHS/IEC for the PA600 series's optional laser scanner module is located on the memory compartment cover, on the back of the unit.

CAUTION! Use of controls or adjustments or performance of procedures other than those specified herein may result in hazardous laser light. Use of optical instruments with the scanner will increase eye hazard. Optical instruments include binoculars, microscopes, and magnifying glasses. This does not include eye glasses worn by the user.

Battery Notices

This unit is equipped with a battery pack and backup battery. Both batteries will discharge after an extended period of not being used.

When both batteries are discharged, recharge the unit for 16 hours in order to fully charge the main battery and backup battery. There are two ways to recharge PA600:

1. Plug the USB charging cable to the PA600 and plug the 5V/2A AC-DC adapter to the power jack of the USB charging cable.
2. Place the PA600 into the docking station and plug the 5V/2A AC-DC adapter to the power jack of the docking station.

For more details, refer to page 8, Charging the Battery.

If the main battery is removed, the backup battery ensures the data on SDRAM is safe for up to 6 hours. To prevent data loss, do not leave the PA600 uncharged with the main battery removed for an extended period.

Battery charge notice

It is important to consider the environment temperature whenever you are charging the Lithium-Ion battery pack. The process is most efficient at normal room temperature or slightly cooler. It is essential that you charge batteries within the stated range of -5°C to 50°C. Charging batteries outside of the specified range could damage the batteries and shorten their charging life cycle.

Storage and safety notice

Although charged Lithium-Ion batteries may be left unused for several months, their capacity may be depleted due to build up of internal resistance. If this happens they will require recharging prior to use. Lithium-Ion batteries may be stored at temperatures between -20°C to 60°C, however they may be depleted more rapidly at the high end of this range. It is recommended to store batteries within normal room temperature.



Table of Contents

Preface

About This Manual	i
Regulatory Compliance Statements	i
FCC Statement	i
Canadian Compliance Statement	i
European Conformity Statement	i
Laser Information	ii
Battery Notices	ii
Battery charge notice	ii
Storage and safety notice	iii

Chapter 1

Getting Started	1
Introducing the PA600	1
Features	2
Package Contents	3
A Tour of the PA600	4
Front Left View	4
Back View	5
Getting Started	6
Installing the Battery	6
Charging the Battery	8
<i>Charging the Battery using the USB Cable</i>	8
<i>Charging the Battery with the Docking Station</i>	9
<i>Checking the Battery Status</i>	9
Connecting the PA600 to a PC	10
Turning the PA600 on for the First Time	11
<i>Powering On</i>	11
<i>Calibrating the PA600 Screen</i>	12

Chapter 2

Using the Hardware	14
Keypads and Function Buttons	14
Adjusting the Screen Brightness	16
Using the Stylus	16
Using the SD/MMC memory card	17
<i>Inserting a Storage Card</i>	17
<i>Removing a Storage Card</i>	17
Using the Laser Scanner	18

Chapter 3

Getting Connected	20
Establishing Device-PC Connection	20
Installing Microsoft ActiveSync	20
Connecting the Device to Your Computer	23
Synchronizing with Your Computer	24
Connection options	24
<i>USB Connection</i>	24
<i>Infrared Connection</i>	25
<i>Bluetooth Connection</i>	26
<i>WiFi Connection</i>	29
Synchronizing Information	31
Synchronization Options	31
Using ActiveSync to Exchange Files	31

Chapter 4

Barcode Scanner Programs	33
Scan2Key	33
Scanner Setting	33
Barcode Symbolologies	34

Chapter 5

Advanced settings	35
Adjusting Settings	35
Checking the Main and Backup Battery Status	36
Extending Battery Life	37
Changing the Automatic Power Settings	37
Adjusting Backlight Setting	38
Viewing Flash Memory Files	39
Performing a hardware reset	40
Performing a Warm Boot	40
Performing a Cool Boot	41
<i>Method 1</i>	41
<i>Method 2: Registry Cleanup</i>	42

Appendix

System Specifications	43
-----------------------	----

Getting Started

Introducing the PA600

Thank you for purchasing the PA600 PDA Barcode Scanner. Your PA600 was designed for user who need a compact and durable PDA for data collection and real time transactions.

The PA600 is a rugged, compact and lightweight palm-size computer using the Windows Mobile 5.0 operating system, and incorporating an integral bar code scanning laser device, color LCD with touchscreen, keypad, IrDA interface, and wireless communication capability. It provides users with a standard Windows-based environment for customizing and operating the device.

To reduce TCO, the PA600 is sealed to meet IP54 standards and has undergone multiple drop tests to prevent downtime.

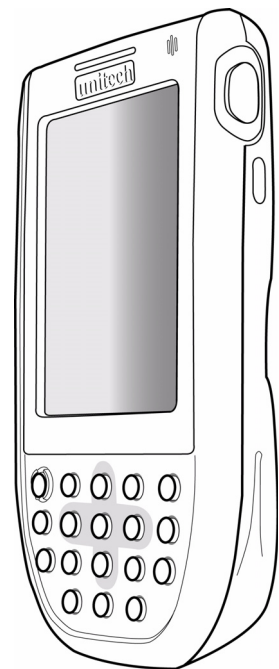

Features

Powerful system

- Microsoft Windows Mobile 5.0 operating system
- Intel PXA270 processor with speed of up to 520 MHz

System memory

- 64 MB SDRAM
- 128 MB Flash ROM

Display

- 3.5-inch QVGA LCD touch-sensitive screen
- 320 x 240 resolution

Barcode scanner

- Built-in Bar Code Scan Engine
- Built-in vibrator for scanning indication
- CCD scan engine (optional)
- Symbol SE950 support
- UNITECH HAMSTER barcode decoder

Communication

- USB Host & Client
- IrDA 1.2 (SIR)
- GPRS (Data Only)
- VOIP support
- 802.11b/g for power saving
- Bluetooth version 1.2 (supports Bluetooth Printer, Bluetooth Modem, Bluetooth ActiveSync)

Audio

- Voice recording and playback
- MIC
- Speaker
- Headset Connector
- Receiver

Wireless connectivity

- 802.11b + g with diversity antenna
- Bluetooth wireless technology
- Serial infrared port

Expansion slot

- Accomodates Secure Digital (SD) memory cards and can serve as a SDIO port.

Battery life



- Batch usage with 50% backlight: 12 hours
- RF enabled usage with 50% backlight: 6 hours
- Charging time: 3.5 hours
- Embedded backup battery cell

User-friendly interface

- Quick launch hot keys for enabling backlight, calibration, software keyboard, and other device management tasks
- Trigger keys for barcode scanning

Package Contents

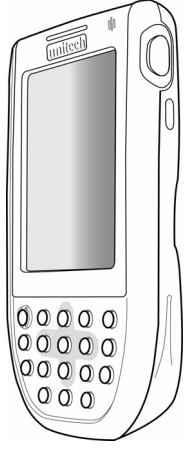
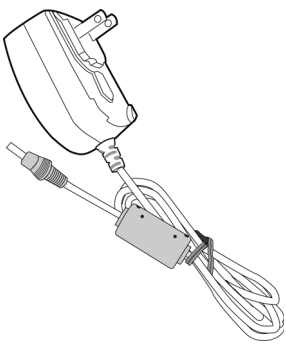
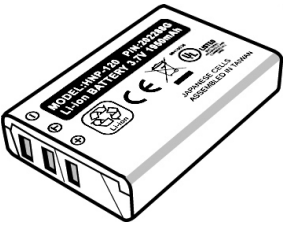
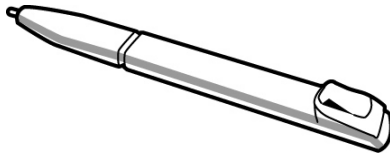
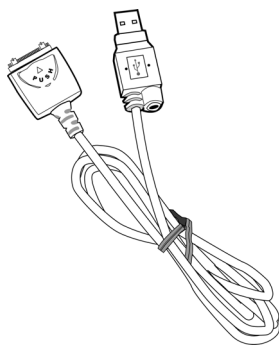
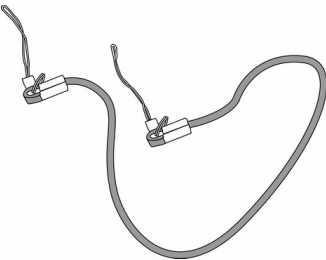
After opening the box, ensure the following accessories for the PA600 are present:

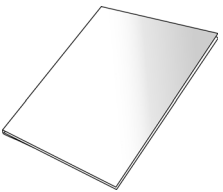
			
PA600 Terminal		AC Adapter	
			
Battery Pack	Stylus		
			
USB Charging Cables	Elastic Stylus String	CD-ROM	Quick Reference Guide

If anything is missing or appear damaged in any way, contact your dealer.

A Tour of the PA600

The following sections describe the main components and features of the PA600.

Front Left View

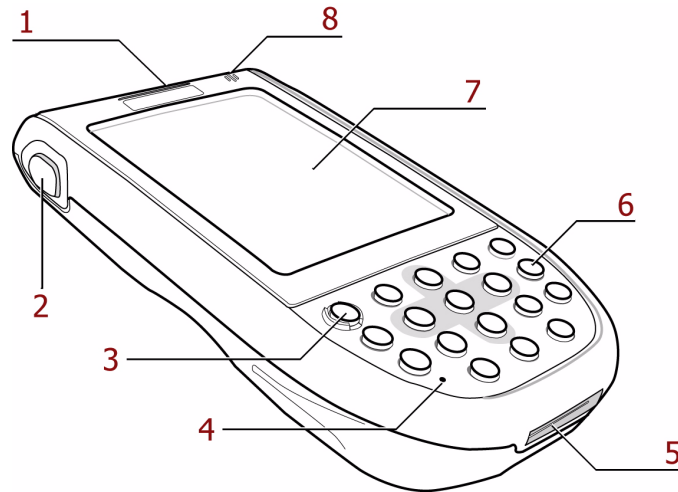

No.	Component	Description
1.	Status indicator	Indicates the battery charging and barcode scanning status. Green - Battery is fully charged or barcode scanning process is completed without error. Red - Battery is charging, barcode scanner is fired / activated.
2.	Left scanner trigger button	Press to activate the barcode laser scanner.
3.	Power button	If the device is off, press this button to turn it on. Alternatively, when the unit is on, this key must be pressed and held down for about two seconds in order to turn the device off.
4.	Microphone	Enables you to record voice audio.
5.	Universal connector	Connects your device to a USB charging/communication cable. This USB cable connects to the computer's USB port and accepts the 5V AC adapter to provide power to the PA600. See page16 for further instructions. The unit can simultaneously recharge and perform an Activesync operation. You can also use it to connect peripheral hardware, such as a docking station, to your device. This port can also support USB and RS232 hosting for devices such as a USB or RS232 scanner, keyboard, or USB memory key.
6.	Keypad	Keypad interface for controlling the PA600. See <i>Keypads and Function Buttons</i> on page 14 for more information.
7.	LCD Touch screen	Displays the applications and data stored on your device. It is touch-sensitive and responds to the stylus or finger.
8.	Speaker	Enables you to hear audio from the PA600.

Back View

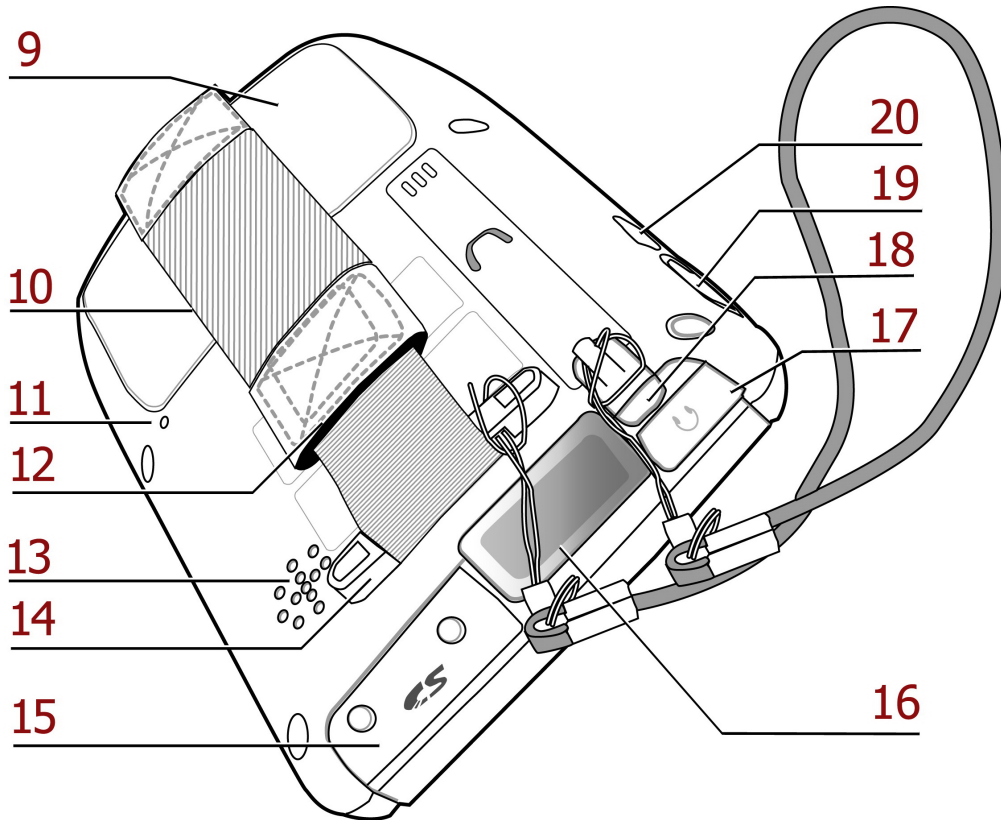

No.	Component	Description
9.	Battery compartment	Houses the Removable and rechargeable 3.7 V, 1950 mAH battery pack
10.	Battery compartment release latch	Opens the battery compartment.
11.	Reset button	Press the end of the stylus into the button to reset your device.
12.	Handstrap	Enables you to securely hold the PA600 while using it.
13.	Speaker	Enables you to hear audio from the PA600.
14.	Strap holder	Attachment location for holding hand strap, carrying strap, and stylus.
15.	Memory card slot	Accommodates Secure Digital memory cards and can serve as a SDIO port.
16.	Barcode scanner window	Used to scan barcodes.
17.	Earphone jack	Connects to audio line-out devices (earphones or headphones) for use in noisy environments.
18.	Stylus	Enables you to interact with the operating system. To use the stylus, remove it from its holder and hold it the same way you hold a pen or pencil.
19.	Right scanner trigger button	Press to activate the barcode laser scanner.
20.	Infrared (IR) port	Uses infrared technology to transmit and receive data from other IR-enabled devices.

Getting Started

This section explains how to install and charge the battery, how to check battery status, how to turn on the PA600, and how to calibrate the screen.

Installing the Battery

WARNING! There is a risk of fire and burns if the battery pack is handled improperly. DO NOT disassemble, crush, puncture, short external contacts, or dispose the battery pack in fire or water. DO NOT attempt to open or service the battery pack. Dispose of used batteries according to local recycling guidelines in your area.

A backup battery cell is embedded into your device to prevent data loss in instances when the removable battery pack is removed or completely discharged. The backup battery will keep the data and system setting for up to 6 hours if the main battery is removed.

NOTE: To enable the internal battery cell to provide backup power supply, charge your device with the main battery pack for at least 16 hours.

1. Open the battery compartment by pushing the latch in the direction of the arrow and lifting up.

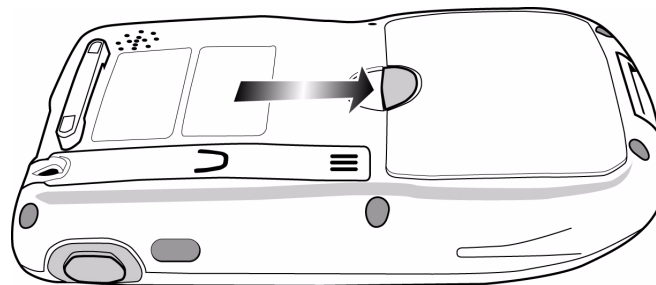

The battery compartment is displayed:

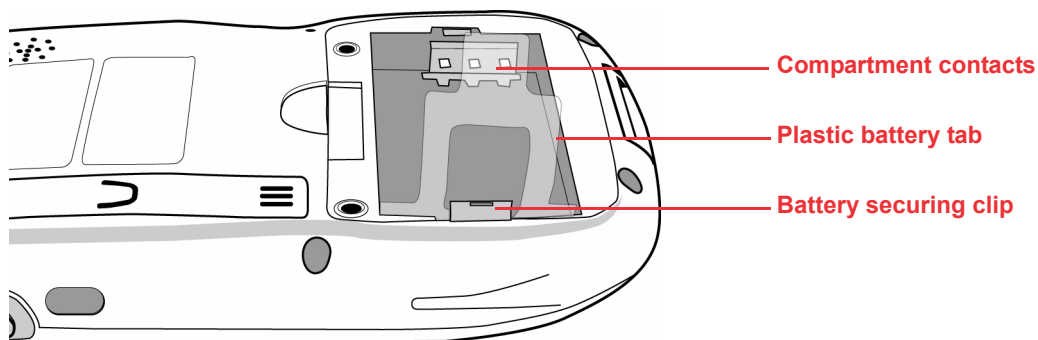

NOTE: The plastic battery tab makes it easy to remove the battery.

2. Locate the backup battery switch and turn it on.

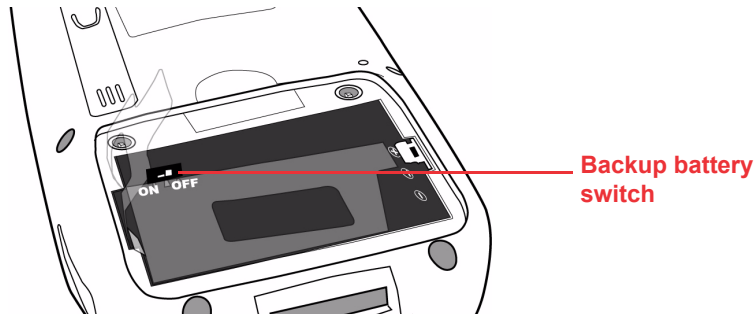

3. Position the battery pack, making sure the battery contacts are aligned with the contacts in the compartment and the battery is placed on top of the plastic tab, as shown in the following illustration.

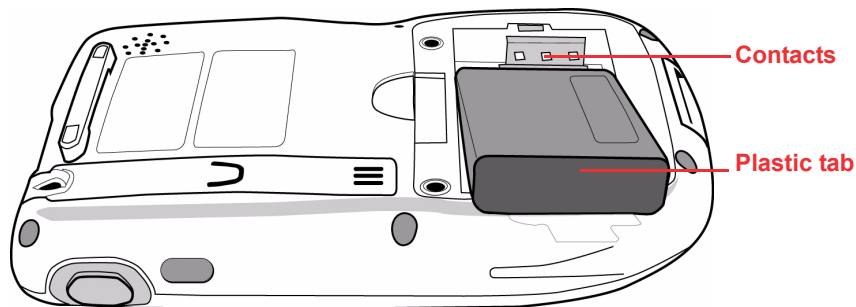

4. Slide the battery pack into the battery bay while simultaneously pulling the plastic tab and securing clip until the battery clicks into place.

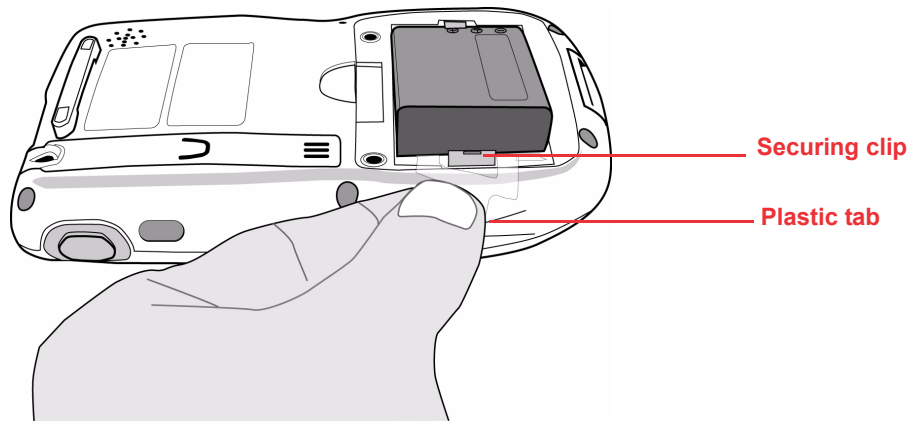

5. Replace the battery compartment cover.

Charging the Battery

Before using the PA600 for the first time, you need to charge it for about 16 hours. After that, you can charge the PA600 every day to recharge the battery to full capacity. Charge the PA600 using the USB charging cable or the docking station.

CAUTION! Operating the PA600 for the first time without the AC adapter, and without fully charging the backup battery may result in loss of data stored in RAM memory. When the battery is removed, the backup battery retains RAM data in memory for 6 hours, please charge the battery for the period to avoid the data loss in RAM memory.

NOTE: Data you enter may not be properly stored until the built-in backup battery has been adequately charged.

Charging the Battery using the USB Cable

1. Press and hold the connector button on the USB charging cable and connect it to the PA600 (1).
2. Plug the AC adapter cable into the power jack on the USB charging cable (2).
3. Connect the AC adapter into an electrical outlet (3).

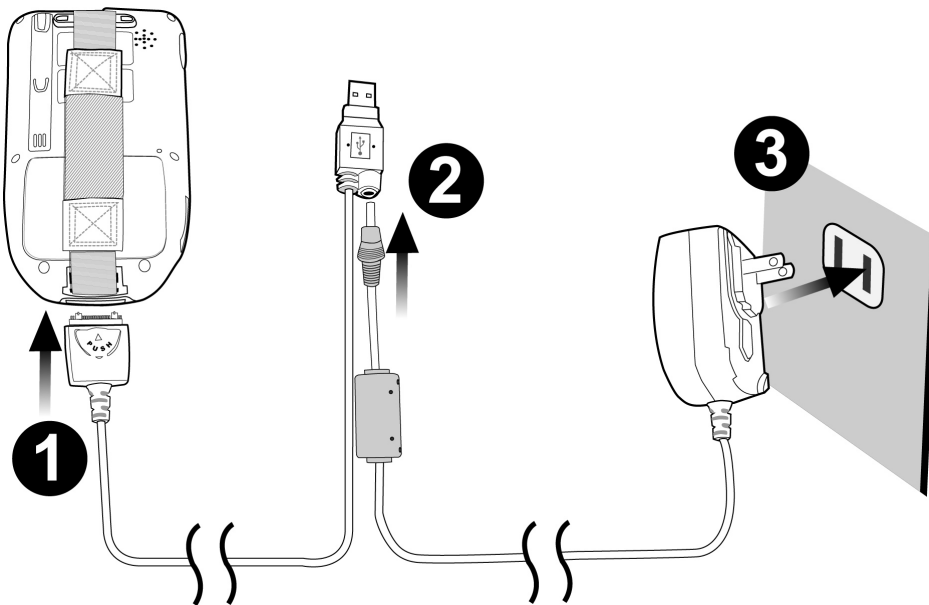

Charging the Battery with the Docking Station

1. Plug the AC adapter cable into the power jack on the docking station, then connect the AC adapter into an electrical outlet.

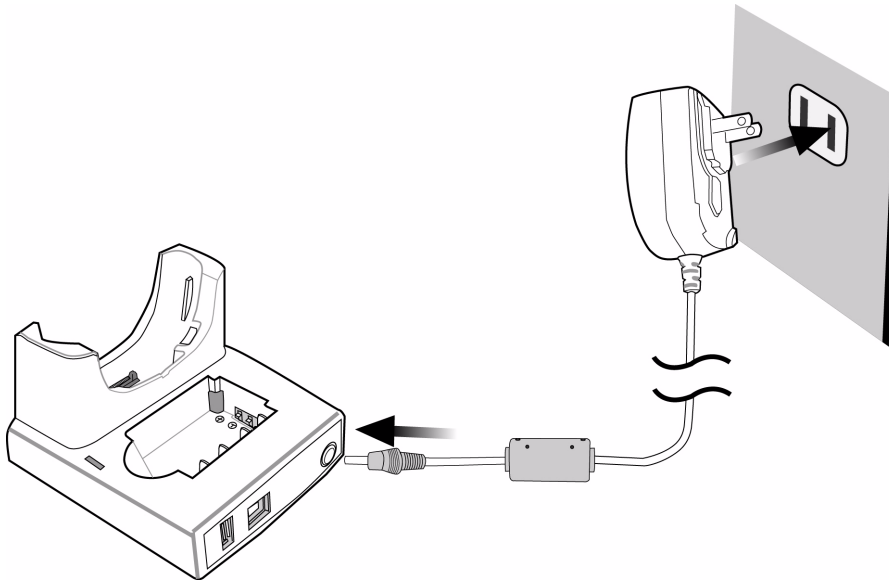

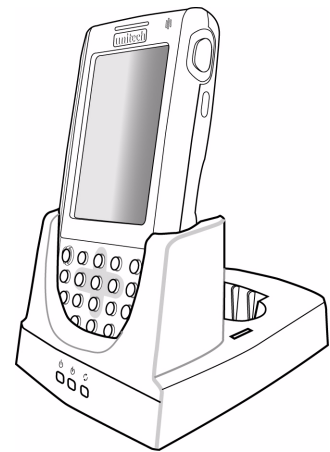

2. Slide the device into the docking station until it clicks into place.



3. The connection is secure when the bottom edge of the device is aligned with the docking station, and the LED indicator on the device lights up red.

LED Status

	LED	Meaning
PA600	Solid Red	Charging
	Solid Green	Charging complete
Docking Station	 Power LED	Power is on
	 Charging LED:	Charging (For Spare Battery Only)
	 Sync LED	Synchronization is taking place

Checking the Battery Status

If the battery level becomes low in the course of normal use, a status icon appears on the device screen indicating low or very low battery status. In both cases, perform an Active-Sync operation to back up your data, then recharge your device as soon as possible.

If the battery level reaches a low status, the device will enter sleep mode and cannot be powered up until the battery is charged. Windows Mobile 5.0 will retain installed applications and data when the main battery is completely drained for extended periods of time.

Connecting the PA600 to a PC

Use the USB cable to connect the PA600 to a PC to use with ActiveSync.

1. Press and hold the connector button on the USB charging cable and connect it to the PA600 (1).
2. Plug the USB connector into the USB port on the PC and connect the AC adapter into the USB connector (2).
3. Connect the AC adapter into an electrical outlet (3).

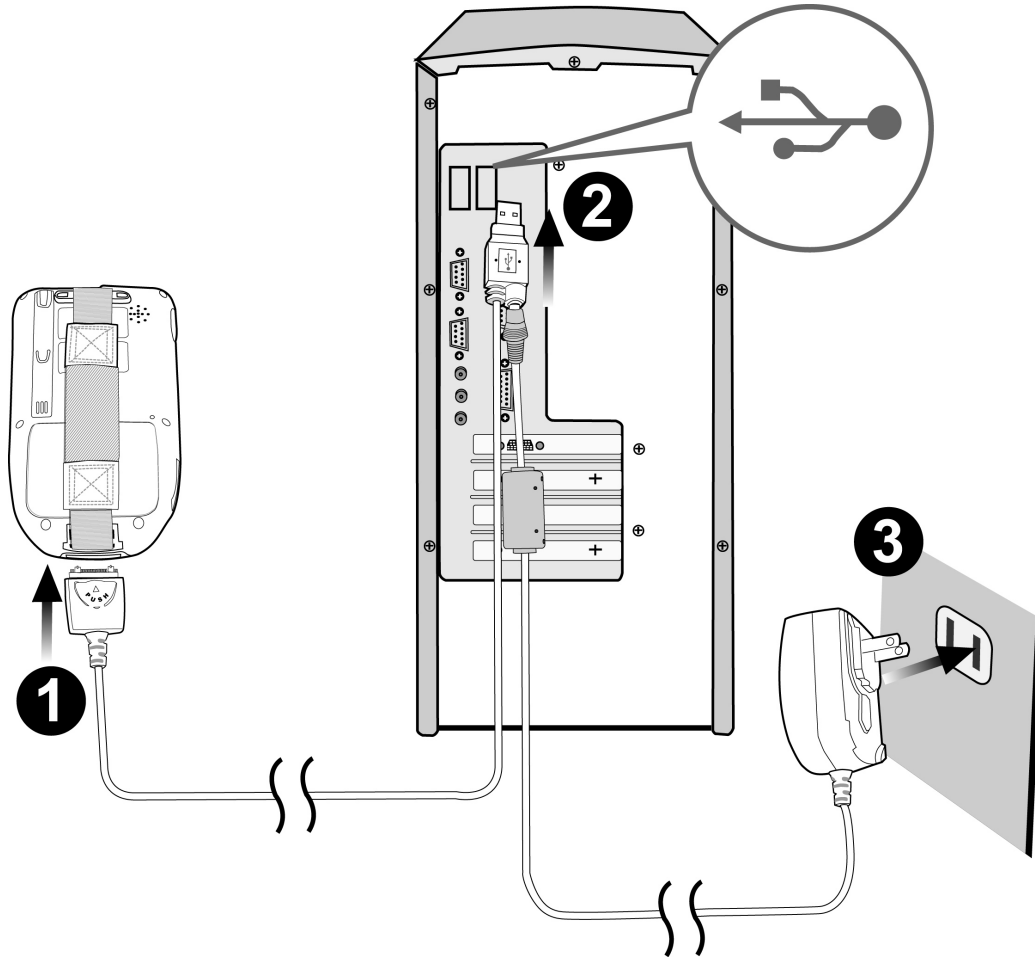

Turning the PA600 on for the First Time

After you have initially charged your device for about 12 hours, the device is ready to be used. You can now start up your device where you'll calibrate the display, learn some basic stylus usage, and set up the system time zone, date and time.

Powering On

1. Turn on your device by pressing the power button on the front panel.

NOTE: The PA600 screen ships with a protective plastic film. You may remove this if desired by peeling from one corner. The screen will be more susceptible to scratching without the film, but will be more readable.

2. The Unitech PA600 welcome screen appears for a moment followed by the Windows CE screen.

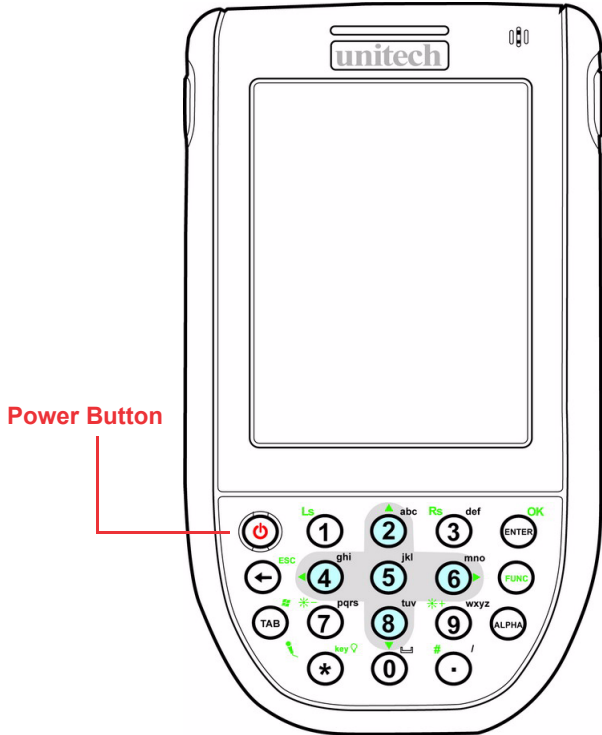

Calibrating the PA600 Screen

The calibrate screen automatically appears when the unit is powered-on for the first time or after the system is reset.

To calibrate the screen at any time, follow these instructions.

1. Tap **Start** → **Settings**, and then switch to **System** tab.
2. Tap the **Screen** icon.

Or

Press Func key and ESC key simultaneously.

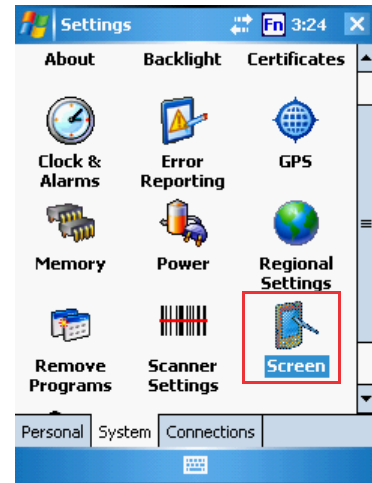

The Screen Settings window appears. This window enables you to customize the screen settings.

3. Tap **Align Screen** to calibrate the screen. The align screen window appears.
4. Tap the cross hair firmly and accurately.

The cross hair moves to the next location.

5. Continue tapping the cross hairs until the screen has been calibrated.

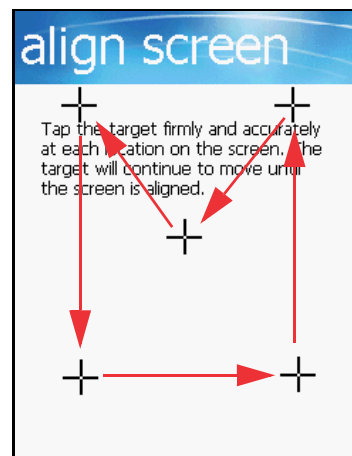
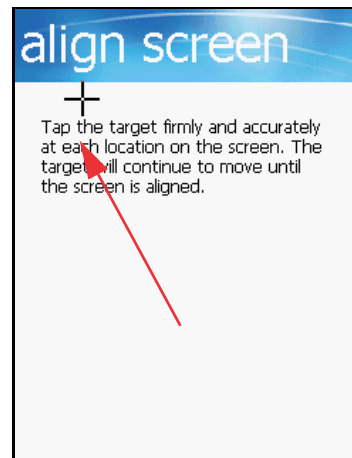
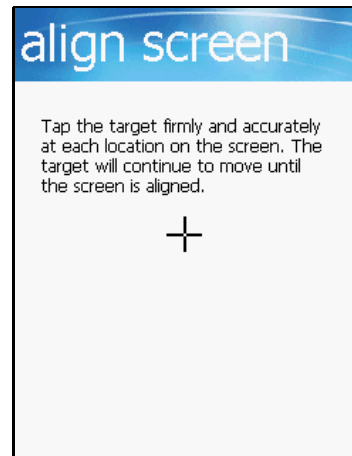
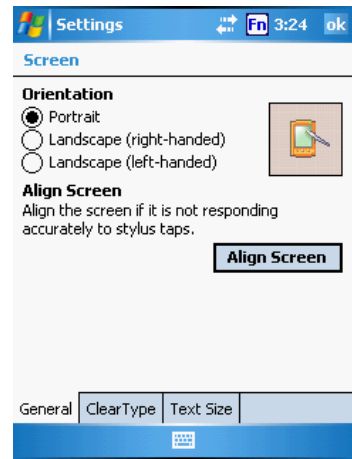

Using the Hardware





Keypads and Function Buttons

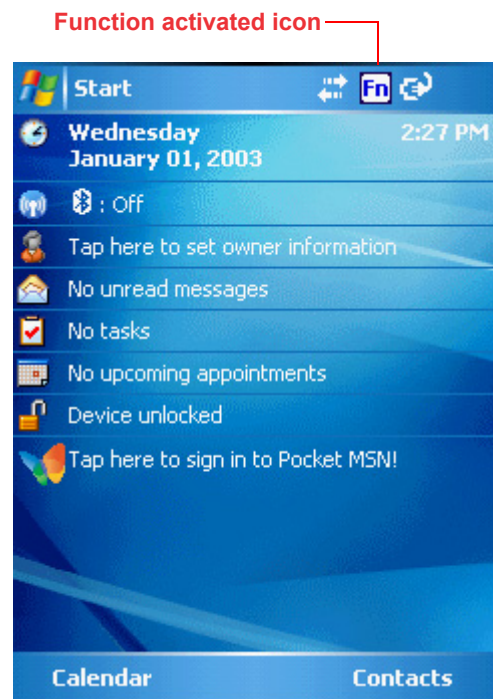













The keypad enables you to both enter information and interact with the PDA operating system and also operate secondary functions using the function button. When the green function button is pressed, the green icon functions on the keypad become available.

When the Function button  is pressed, an icon appears in the operating system:



The following table describes the keypad keys.

Key	Main Function	Secondary Function
	Turns the PA600 on and off.	—
	Number 1	Left soft key - activates function above in LCD screen.
	Alphanumeric 2, a, b, c	Up navigation key
	Alphanumeric 3, d, e, f	Right soft key - activates function above in LCD screen.

Key	Main Function	Secondary Function
	Enter key	OK
	Back space	Escape key
	Alphanumeric 4, g, h, i	Left navigation key
	Alphanumeric 5, j, k, l	—
	Alphanumeric 6, m, n, o	Right navigation key
	—	Enables disables secondary function keys
	Tab	Windows key opens Start menu
	Alphanumeric 7, p, q, r, s	Decreases screen brightness
	Alphanumeric 8, t, u, v	Down navigation key
	Alphanumeric 9, w, x, y, z	Increases screen brightness
	Alpha	—
	Asterisk	Illuminates keypad
	Number 0, space	—
	Period	Pound

Adjusting the Screen Brightness

Adjust the screen brightness by pressing the Function button to enable the soft keys and pressing the 7 (decrease brightness) or 9 (increase brightness) buttons.

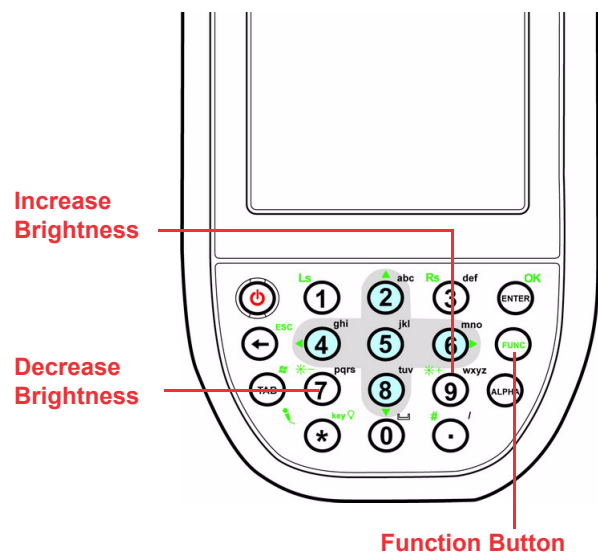

Using the Stylus

CAUTION! Never use anything other than the PA600 stylus on the screen. Using another object as a stylus could cause permanent damage.

1. Remove the stylus from its holder.

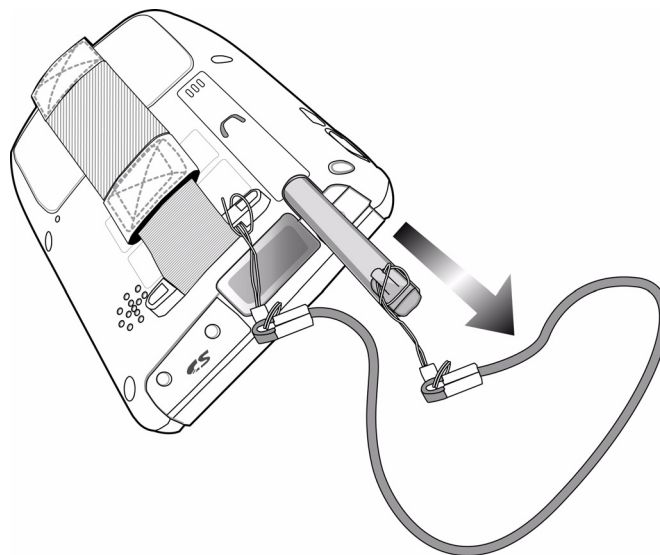

2. Hold the stylus as you would a pencil.
3. To make a choice from a menu, lightly tap the tip of the stylus on that choice.
4. To write data into a field on a form, use the stylus to print the letters or numbers. Use very light pressure.

Using the SD/MMC memory card

Your device has an expansion slot compatible with a range of SD and MMC storage cards, which are primarily used to back up or transfer files and data. The slot also supports SDIO cards for added connectivity options.

Inserting a Storage Card

1. Remove the two screws from the SD compartment cover and remove the cover.

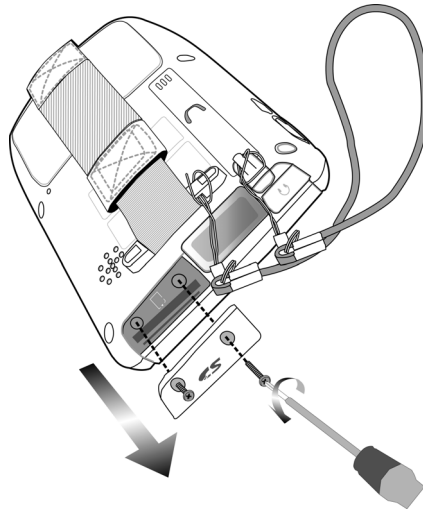

2. Insert the SD card with the notched corner as shown by the icon on the case.

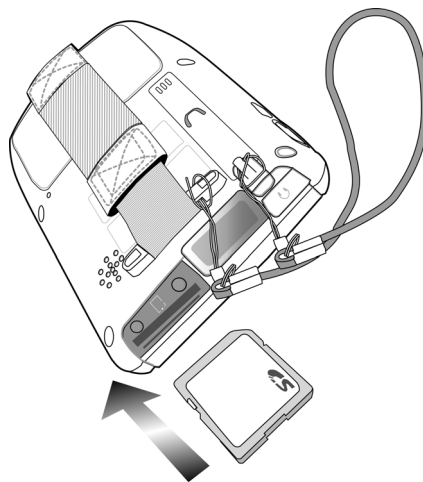

3. Push the card into the slot until you feel the SD card click into place; this will signal that the card is properly seated within the slot. The card is secure when it is not protruding from the slot. The SD compartment cover can be screwed back into place when a SD/MMC card is inserted.

Removing a Storage Card

1. Remove the two screws from the SD compartment cover and remove the cover.
2. Press the card in and release. The card pops out.
3. Remove the card from the slot.

Using the Laser Scanner

The PA600 has an integrated laser scanner which reads all major bar code labels with excellent performance.

NOTE: Reading software must be enabled in order to operate the scanner. This can be a user-loaded application or a pre-loaded utility such as Scanner Setting or Scan2Key.

Activate the laser scanner by pressing either one of the trigger keys located on the left and right side of the unit.

The PA600 has a built-in Scanner Setting utility that allows you to test the device's barcode scan function.

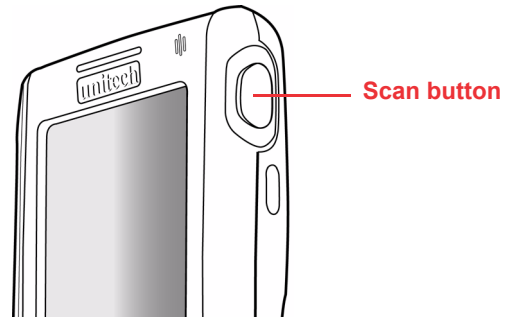

1. To launch Scanner Settings, tap **Start** → **Settings** → **System** → **Scanner Settings**.

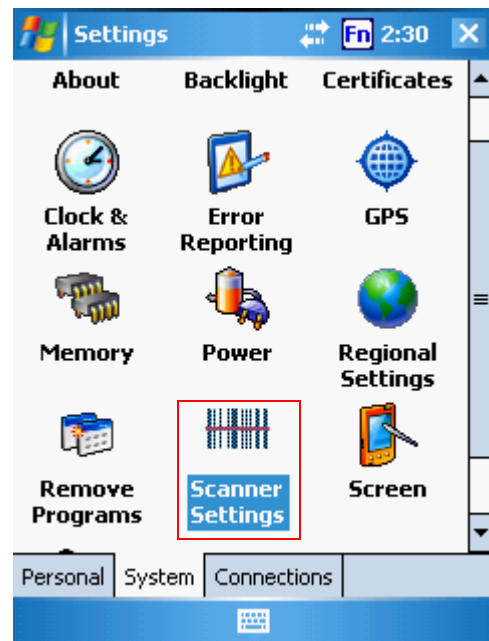

2. The Scanner Control Panel opens.

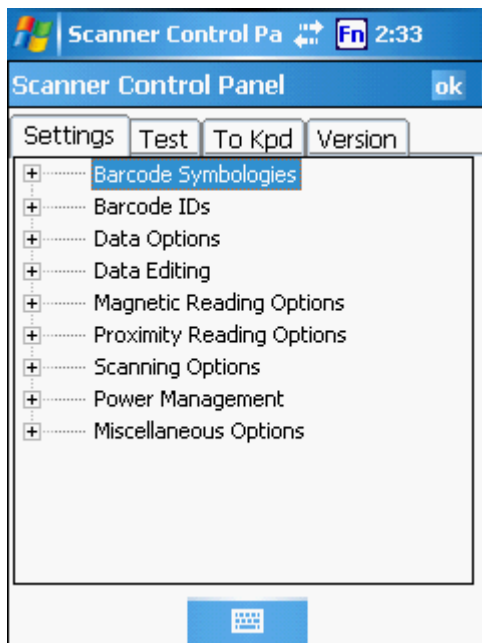

From here you can configure barcode scanner parameters such as enabling or disabling barcode symbologies, setting data transmission options, configuring magnetic and proximity reading options, and setting power management options.

- To test the barcode scanner, tap the Test tab
- Tap **Tools**.
- Tap **Enable Scan**
- To perform auto scan, tap **Tools --> Auto Scan --> Start auto-scan**.
- Choose Interval: 3 secs
- Tap **Start**
- Laser scan every 3 seconds and barcode is scanned automatically.
- Tap **Tools --> Auto-Scan --> Stop AutoScan**.
- To enable the scanner outside of the test tab, user must enable **Scan2Key.exe**. This can be done via the **To Kpd** tab.
- Check the box labeled "**Start Scan2Key When Exit**" and tap **OK** at the top right. The scanner will be enabled and scans will be directed to the keyboard buffer.

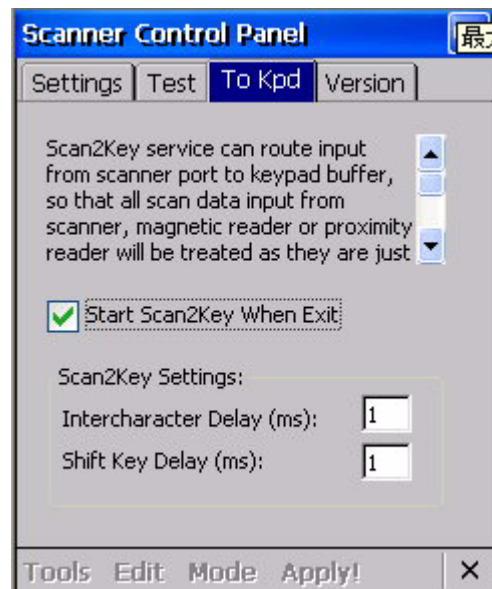
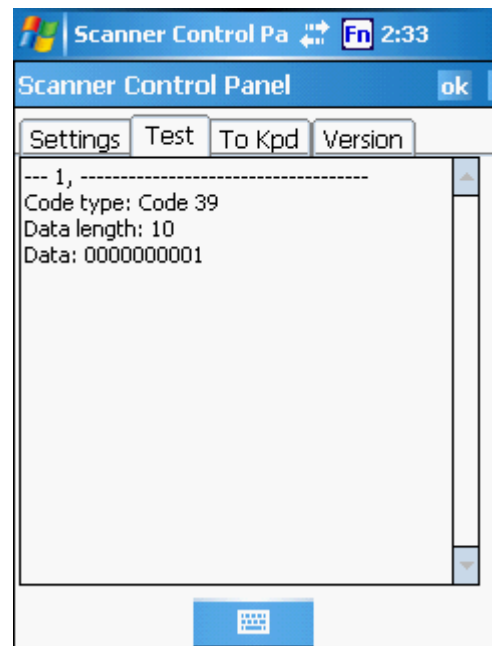

Getting Connected

Establishing Device-PC Connection

Installing Microsoft ActiveSync

In order to exchange data between your computer and PA600, Microsoft ActiveSync must be installed on your computer. Use the USB charging cable that comes with your device to connect the device to your computer.

NOTE: If you have a previous version of the Microsoft ActiveSync installed in your computer, uninstall it first before installing the latest version of Microsoft ActiveSync.

To install Microsoft ActiveSync on your computer:

1. Close any open programs, including those that run at startup, and disable any virus-scanning software.
2. Download the ActiveSync software from the Microsoft ActiveSync Download page at <http://www.microsoft.com/windowsmobile/downloads/activesync42.msp>.
3. Browse to the location of the downloaded file, and double-click it.

The installation wizard begins.

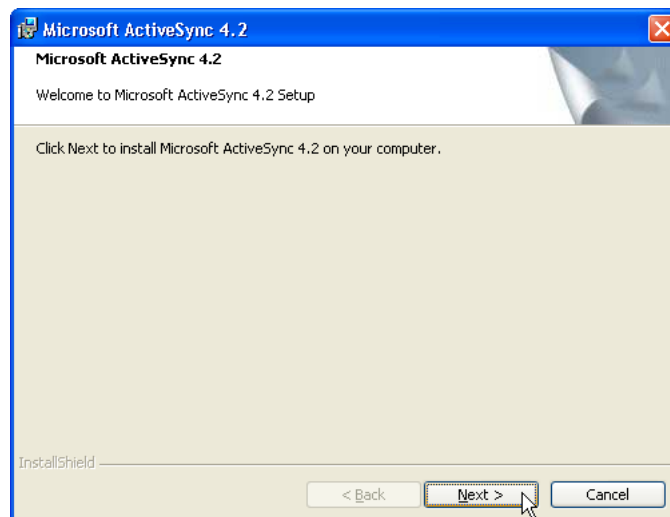

4. Click **Next**.

You are prompted to read the End User License Agreement (EULA).



5. Accept the license agreement terms and click **Next**.

You are prompted for user information.

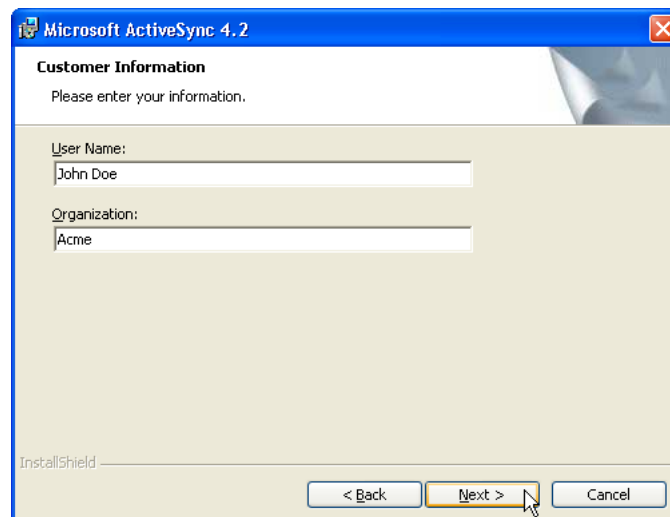

6. Type the user name and organization and click **Next**.

You are prompted for the destination folder.

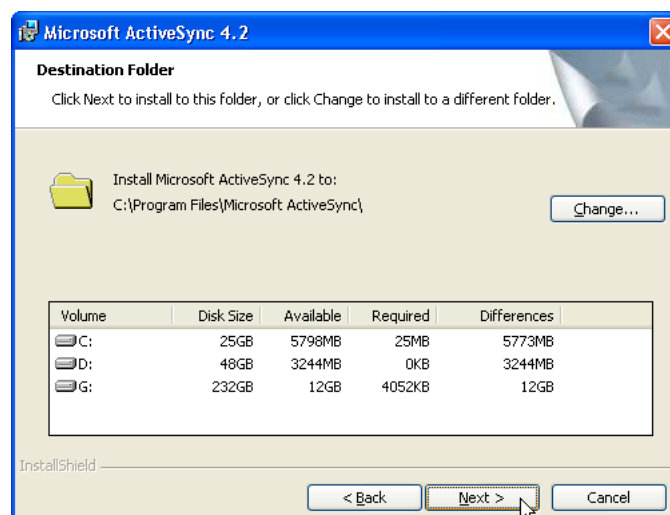

7. Select a drive to install the program to and click **Next**.
The installation wizard has gathered the information it needs to install ActiveSync and prompts you to begin installation.

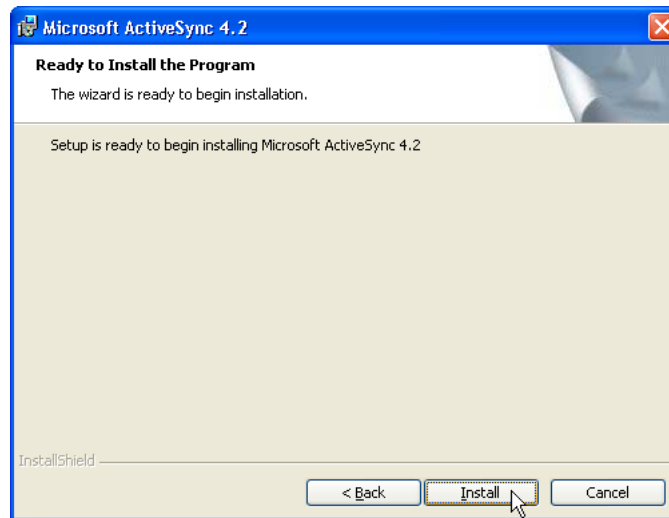

8. Click **Install**.
The program begins installation

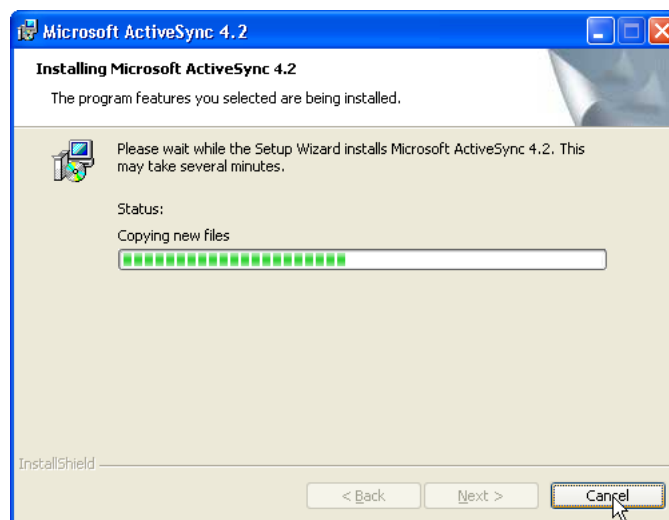

After the program has finished installing you see the following screen.

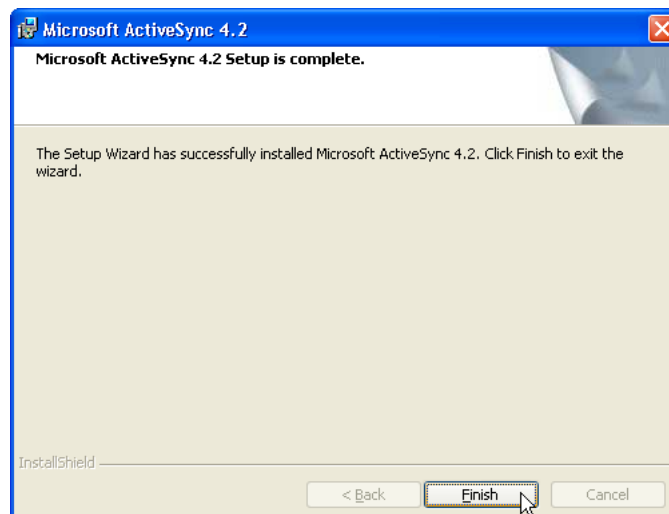

9. Click **Finish**.

You may be prompted to restart your computer.

After you have installed ActiveSync and restarted your computer, the ActiveSync icon  appears in your computer's system tray as shown and ActiveSync Connection Wizard starts. For detailed information on how to use ActiveSync on your computer, start ActiveSync then click **Help** → **Microsoft ActiveSync Help**.

Connecting the Device to Your Computer

1. After ActiveSync has been installed, connect the USB charging cable to the universal connector on the bottom of your device. If necessary, connect an adapter. Refer to *Connecting the PA600 to a PC* on page 10.
2. Plug the other end of the USB charging cable into a USB port on your computer.
3. Turn the device on.
4. ActiveSync starts automatically and configure the USB port to work with the PA600. The New Partnership setup wizard will automatically start.

NOTE: If ActiveSync doesn't start automatically, click **Start** → **Programs** → **Microsoft ActiveSync**.

If a message appears indicating that it is unable to detect a connection, click the **Cancel** button and manually configure the communication settings.

5. Follow the onscreen instructions.
6. When the configuration process is complete, the ActiveSync window appears.

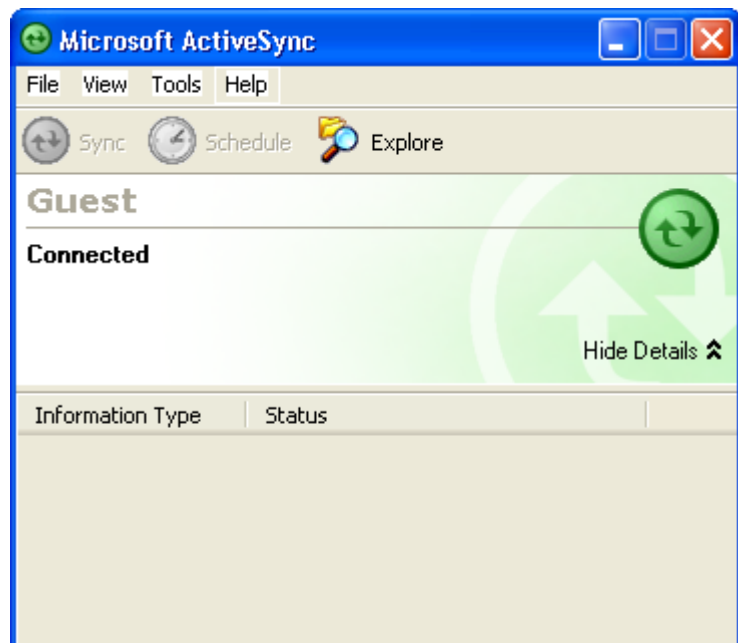

7. Synchronization will be initialized and will take place if you've chosen to synchronize periodically or upon connection.

NOTE: Your computer can create a partnership with multiple PA600s. Also, a PA600 can create a partnership with up to two computers.

Synchronizing with Your Computer

Synchronization takes place according to the options you choose while setting up ActiveSync on your computer. If you accept the default (On Connect) synchronization option in the Microsoft ActiveSync Setup Wizard, you'll be able to simply connect your PA600 to your desktop computer and synchronization will take place.

If you have not enabled the On Connect feature in Active Sync, you can start Active-Sync in either of the following ways:

- On your computer, double-click My Computer → Mobile Devices folder.
- Connect the USB cable between the computer and PA600.

Connection options

You can set remote synchronization with your computer using the following connection options:

- USB connection
- Infrared connection
- Bluetooth connection
- WiFi connection

USB Connection

To synchronize with your computer using a USB connection:

1. Open ActiveSync.
2. Connect your device to your computer using the USB charging cable.
3. Initiate connection by tapping **Start** → **Programs** → **ActiveSync**.
4. Tap **Menu** → **Connections**.
5. Select **Synchronize all PCs** using this connection check box.
6. Select a baud rate or cable type connection.
7. Tap **OK**.

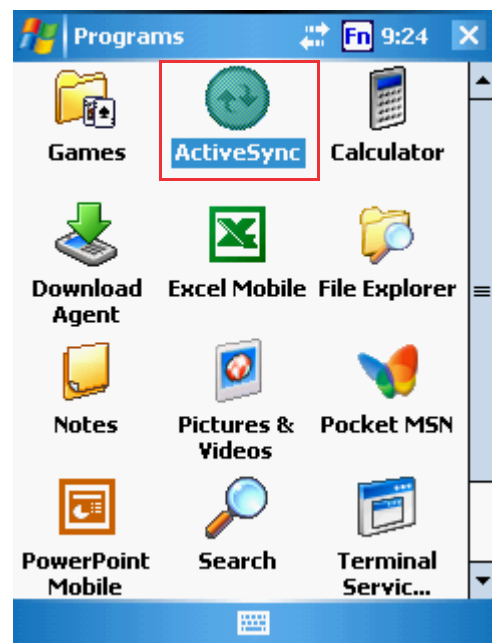

Infrared Connection

The infrared port allows you to synchronize information with an infrared enabled computer. Align the infrared port of your device with the infrared port on the computer.

This method is ideal for quickly switching between multiple devices since there are no cables or adapters to change.

1. Perform the steps below on your computer:
 - a. Configure an infrared port on your computer following the manufacturer's instructions.
 - b. Once your computer's IR port is ready, open ActiveSync.
 - c. Click **File** → **Connection Settings**.

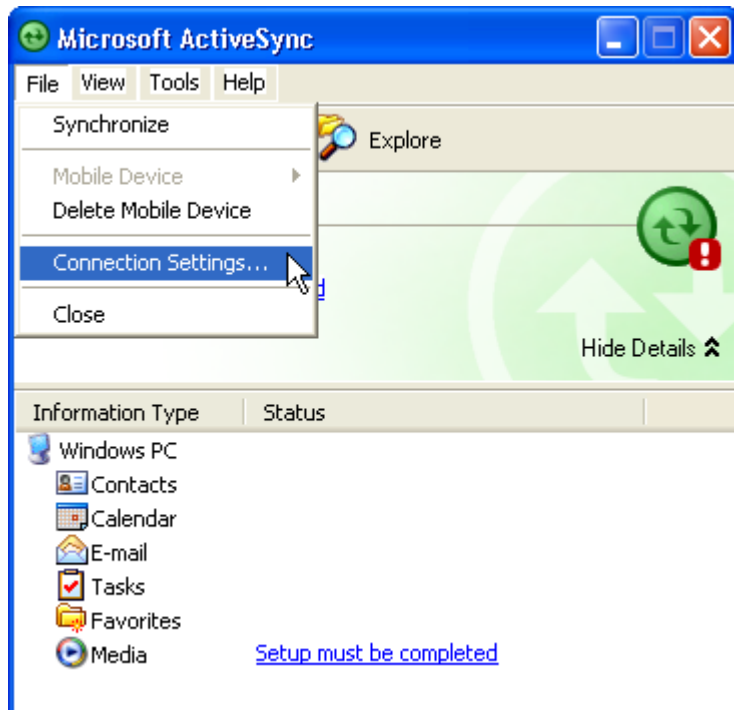

- d. Check **Allow connections to one of the following** and select **Infrared Port (IR)** from the drop-down list.
 - e. Click **OK**.

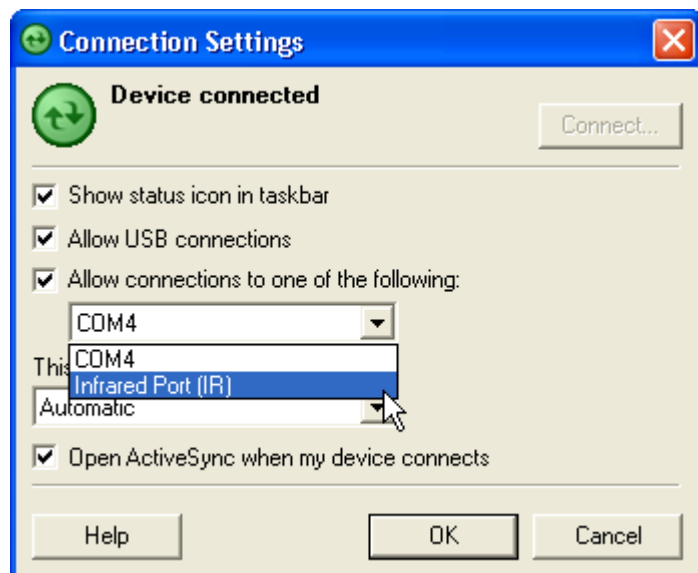

2. Perform the steps below on your device:
 - a. Align the IR port of your PA600 with that on your computer so that they are unobstructed and within close range.
 - b. Initiate connection by tapping **Start** → **ActiveSync** → **Menu** → **Connect via IR**.
 - c. Tap **Sync**.

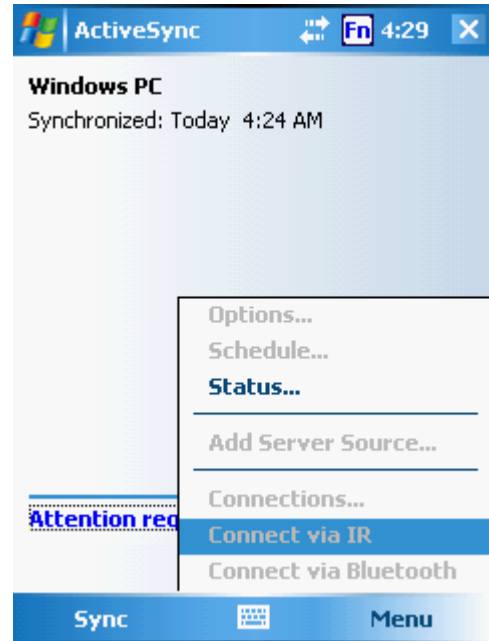

Bluetooth Connection

Your device is equipped with Bluetooth wireless technology that you can use to synchronize information with a computer equipped with a Bluetooth adapter or access point. Bluetooth wireless technology allows you to communicate with the computer whenever it is within range.

Follow these instructions to set up a Bluetooth connection.

1. Tap **Start** → **Settings** → **Connections** → **Bluetooth** → **Mode** and check **Turn on Bluetooth**.

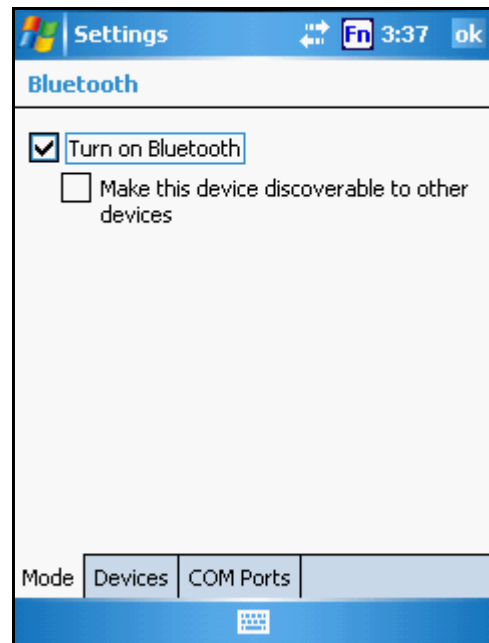

2. Tap **Devices** → **New Partnership...**

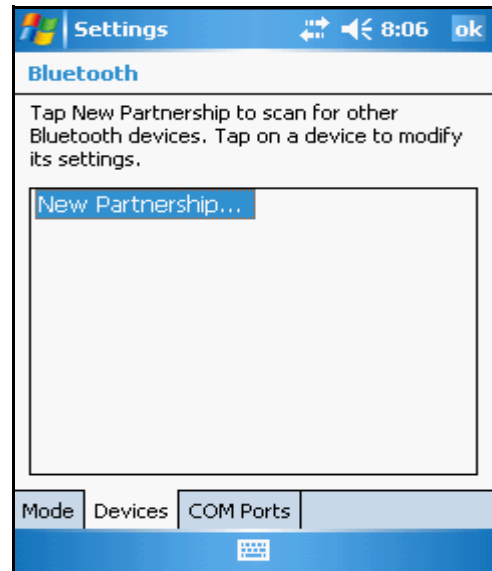

3. Select a device from the list and tap **Next**.

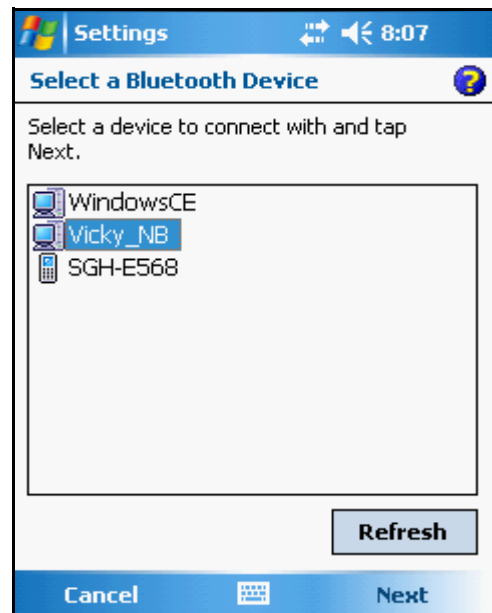

You are prompted for a passkey.

4. Enter the Passkey.

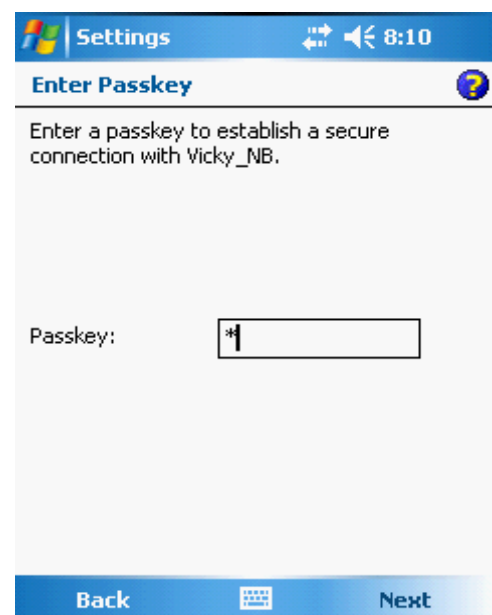

On the PC screen, you are prompted to enter the Bluetooth PIN Code Request.

5. Enter the same Bluetooth PIN Code you entered in step 4.

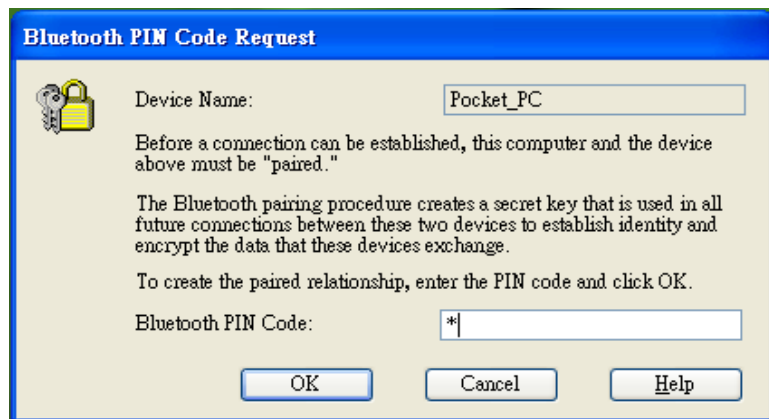

6. Select service. Check **Activesync**. Tap **Finish**.
7. To preserve battery power, be sure to end the bluetooth activesync connection when synchronizing is complete. Tap **OK**.
8. From Start > Program, double tap **Activesync**.
9. Tap **Menu** at the bottom right corner. Select **Connect via Bluetooth**. Terminal connects to the host via Bluetooth Activesync.

WiFi Connection

The terminal come with built-in RF functionality. After setting the network successfully, it will connect to the LAN network automatically. Suspend and warm start will always resume the auto reconnection.

Make the network setting.

(For PA600 Mobile)

1. Tap the RF icon at the bottom of the screen.

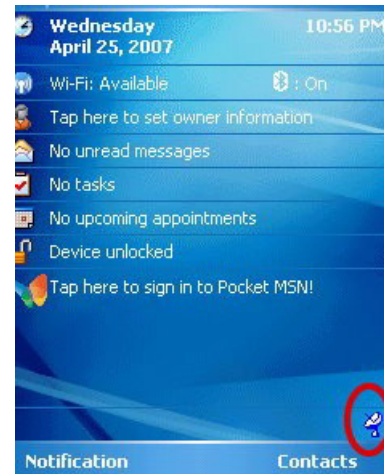

2. A selection menu pop up. Select "Enable Wireless".



3. Once the RF card is detected, a dialog pop up.

4. Select a network SSID to connect to. Select one of the network. Tap **OK**.



5. Select "The Internet". Tap "Connect".



6. Enter the network key. Tap "Connect".

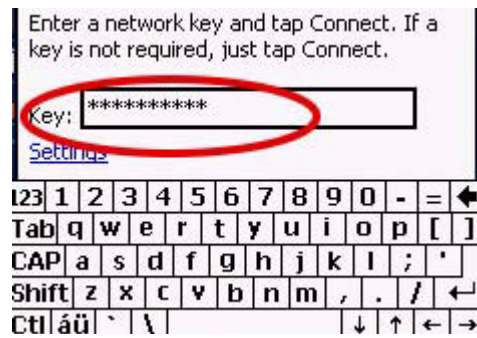

7. Icon turn to double arrow, indicate that the RF connection is running.



8. If you do not need the RF connection, you can repeat step 1 ~ 2 and select "Disable Wireless".

Synchronizing Information

All files created on the device are stored in My Document/PA600 My Document folder (if the designated device name is PA600). You can view files by double-clicking the PA600 My Documents icon on your computer.

If you have enabled file synchronization, your PA600 files are automatically synchronized in the My Documents folder on your computer, unless a different name was chosen for PA600.

Synchronization Options

Synchronization options can be modified, including when you synchronize and what gets synchronized. In the Mobile Device window, click **Tools** → **Sync Options**.

For each type of information, the synchronization process can be hastened by limiting the amount of data to be synchronized. To do this, select a service and click the Settings button. After enabling a service, you must close and reopen the ActiveSync.

Using ActiveSync to Exchange Files

You can use ActiveSync to exchange information from your device your computer and vice versa. Changes you make to the information on one location will not affect the information on the other one. If you want to automatically update information on both your device and computer, synchronize the information instead.

You can copy two types of information to your device: files and Pocket Access Windows CE Store information.

The procedure below only applies to copying files. Refer to the ActiveSync Help on your computer for instructions on how to copy Pocket Access Windows CE Store information.

NOTE: Files created on your computer may need to be converted by ActiveSync so that they can be viewed and edited on your device, and vice versa.

To copy files:

1. Connect your device to your computer.
2. In ActiveSync on your computer, click **Explore**.

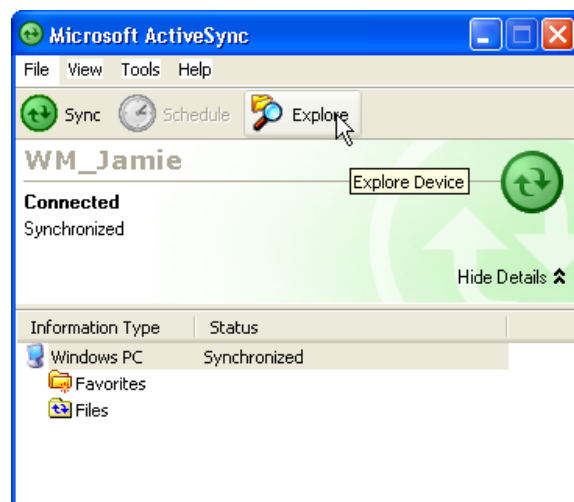

Windows Explorer opens the Mobile Device window for your device.

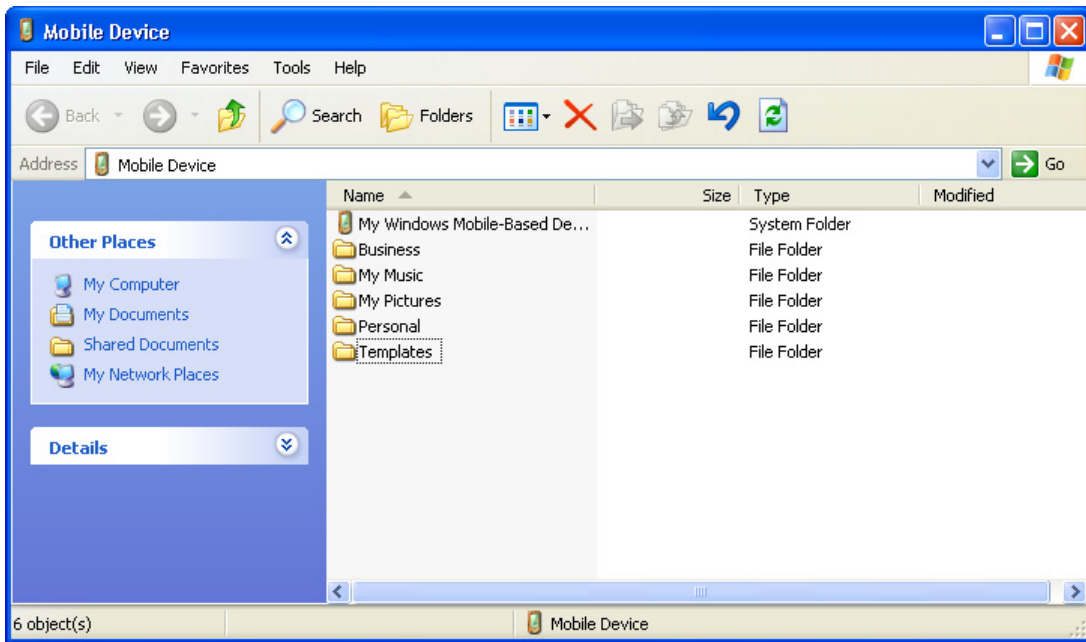

3. Locate the file that you want to copy on your device or computer.
4. Do either one of the following:
 - To copy the file to your device, right-click the file and click **Copy**. Place the cursor in the desired folder for your device, right-click, then click **Paste**.
 - To copy the file to your computer, right-click the file and click **Copy**. Place the cursor in the desired folder for your computer, right click, then click **Paste**.

Chapter 4

Barcode Scanner Programs

Scan2Key

The Scan2Key application routes input from a scanner port to a keypad buffer, making all input from the scanner emulate input from the keypad. Using Scan2Key, scanned data can be directed from the scanner port to any waiting(active/focused) text editor such as MS Mobile Word or a text box in an application.

Scanner Setting

When it is necessary for the user to change the default barcode symbology for a different application, the Scanner Control Panel provides the ability to change default symbology, place delimiter characters behind scanned data, and save the settings.

Tap **Start** → **Settings** → **System** → **Scanner Settings** to display the Scanner Control Panel.

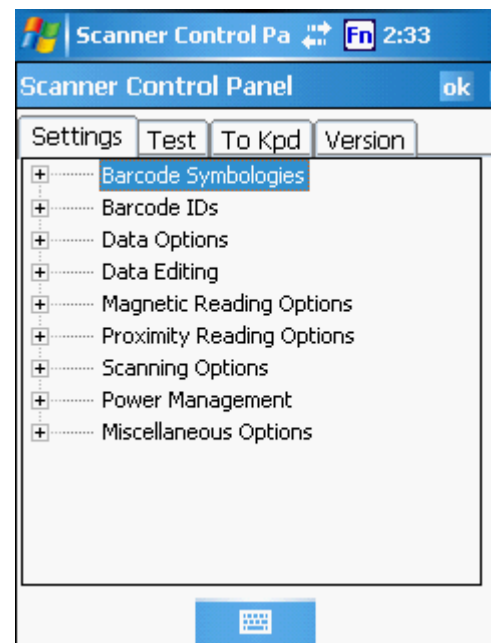

Barcode Symbologies

Barcode Symbology	Enable/Disable	Check Char/Digit verification	Transmit Check Char/digit	Max/Min Length	Transmit Leading Digit	Other
Lookland EAN	YES					
Codabar	YES	YES	YES			Transmet Start/ Stop bits, CLSI format, *data length
Code 11	YES		YES			* check digits, *data length
Code 128	YES					*data length
Code 32	YES				YES	Transmit Tailing digit
Code 39	YES	YES				For ASCII, Transmit Start/Stop bits, Function Code, Double label decoding,*data length, *double labels separator
Code 93	YES		Yes			*data length
Deta Code	YES	YES	YES			
EAN 128	YES		Yes			Transmit Code ID, * Field separator
EAN 13	YES	YES			YES	
EAN 8	YES	YES			YES	* Not suppress first or last digit, *data length
Interleaved 2 of 5	YES	YES	YES			Fixed Length, * Not suppress first or last digit, *data length
Label Code IV&V	YES		YES			
MSI/Plessey	YES		YES			* Check digit double module 10, * data length
Standard 2 of 5	YES	YES	YES			Fixed Length, *Data Length
Telepen	YES					*Standard Character Set
UPC A	YES		YES		YES	
UPC E	YES		YES		YES	Zero Expension,NSC
UPC/EAN Group						Supplement 2, Supplement 5,Insert Space before supplement, most have supplement, *Add-on code try level
* adjustable	Scanner Control Panel, V 3.0					

Advanced settings

Adjusting Settings

This section describes how to adjust the settings of your device to accommodate your work habits.

To access Settings, tap **Start** → **Settings**.

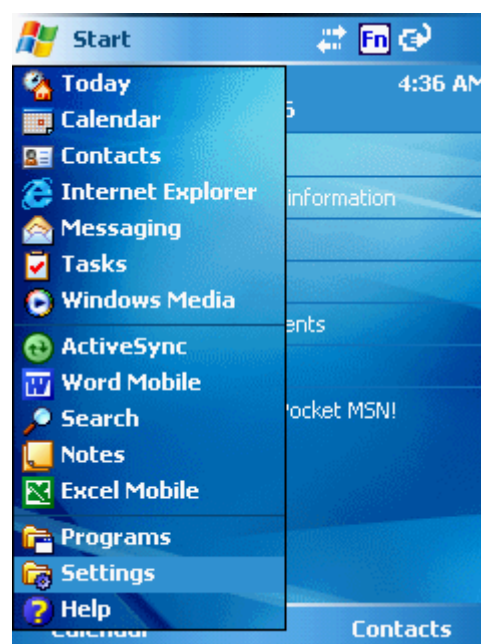

The Settings screen appears.

From here can adjust such user configurable items as the backlight, auto power off timer, system volume, and processor speed. You can also assign functions to buttons, configure menus, enter owner information, and set up connections.

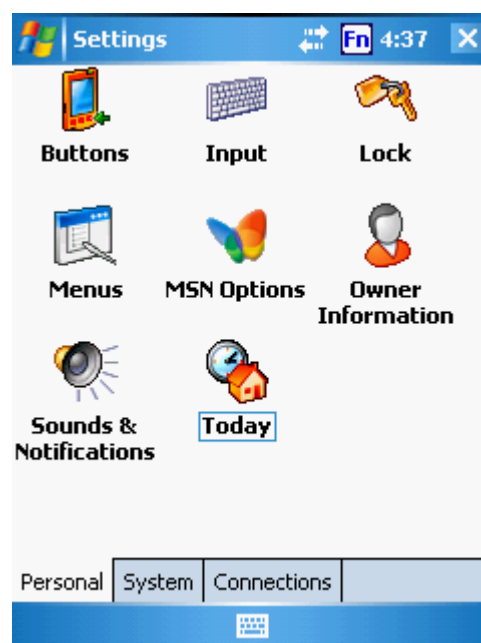

Checking the Main and Backup Battery Status

This section describes how to view the power level for both the main and backup battery. To minimize power consumption, you can define settings for the auto-off function and the processor's operation speed.

To check the main and backup battery status:

1. Open Power Properties. Do either of the following:
 - If the Plug or Battery icon appears on your device, double-tap the icon to bring the Power Properties screen.

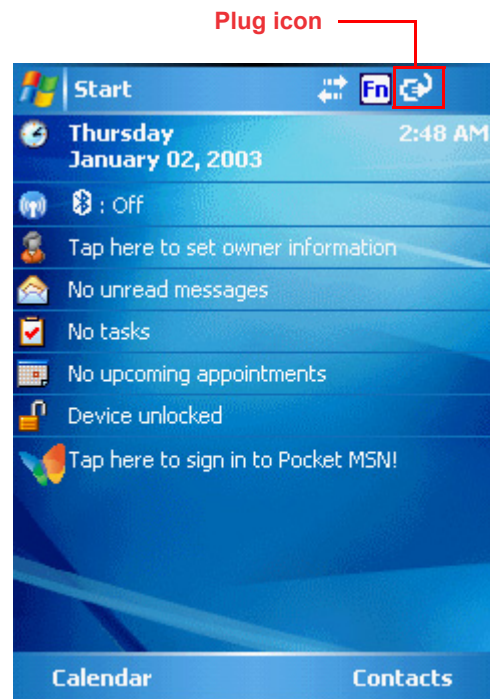

- Tap **Start** → **Settings** → **System** → **Power**.



The Power screen appears.

- The battery menu item displays the status of the main and backup batteries.

On the screen shown here, both batteries are at almost 100% charge.

NOTE: It is necessary to charge the battery when the battery charge reaches below 10%. If the battery does not accept a charge, contact Unitech Technical Support.

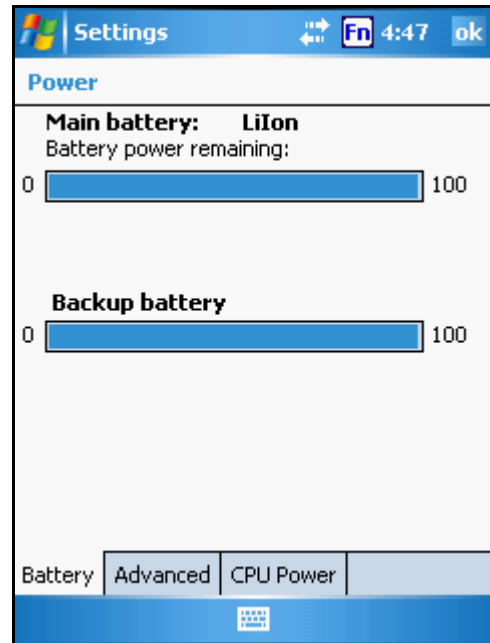

Extending Battery Life

You can extend the PA600 battery life by doing either of the following:

- Change the automatic power settings
- Minimize the use of backlight

Changing the Automatic Power Settings

The PA600 will enter idle mode when there is no task, or all tasks are waiting for input. In default setting, the PA600 automatically turns itself off if it remains idle for 3 minutes and when there is no external charging power connected. Pressing the power button returns the PA600 to the same point at the time of automatic shutdown.

To change the automatic power settings:

- In the Power screen tap the **Advanced** tab.
- Tap the automatic shut off time arrow to select from a list of time periods. The available time periods are 1, 2, 3, 4, and 5 minutes.
- This function can also be activated when the PA600 is plugged into the power adapter or placed in its docking station by tapping the **On external power** check box and then tapping the arrow to select from a list of time periods. The available time periods are 1, 2, 5, 10, 15 and 30 minutes.

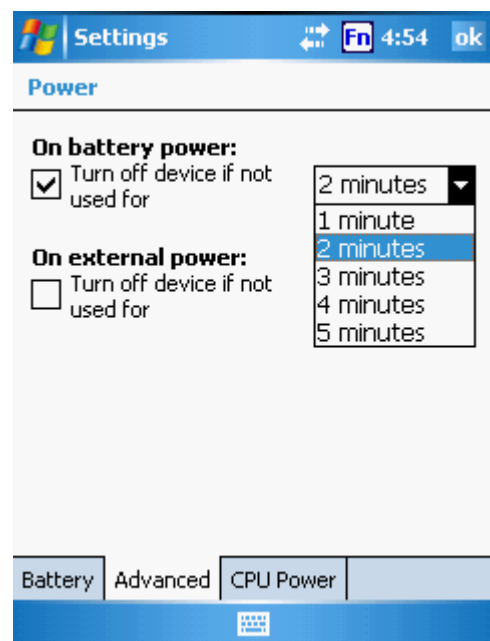

Adjusting Backlight Setting

The power consumption of the LCD backlight is high, turn off the backlight function if it is not necessary.

If a backlight is required, set “automatically turn off the backlight” function.

To change backlight settings:

1. Tap **Start** → **Settings** → **System**.
2. Tap **Backlight**.

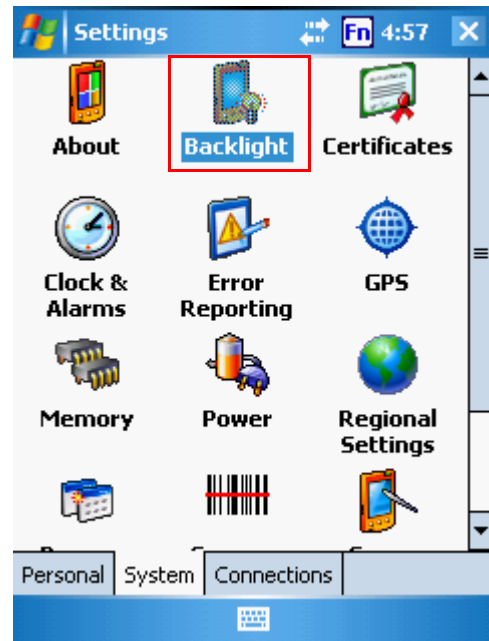

The Backlight screen appears.

3. Do any of the following:
 - In the Battery Power tab, tap the **Turn off backlight if device is not used for** check box and select the amount of time before the unit turns off the backlight while running in battery power mode from the drop-down list.
 - In the External Power tab, tap the **Turn off backlight if device is not used for** check box and select the amount of time before the unit turns off the backlight while running in battery power mode from the drop-down list.
 - Tap **Turn on the backlight when...** checkbox to activate the backlight when the screen is tapped or a key is pressed.

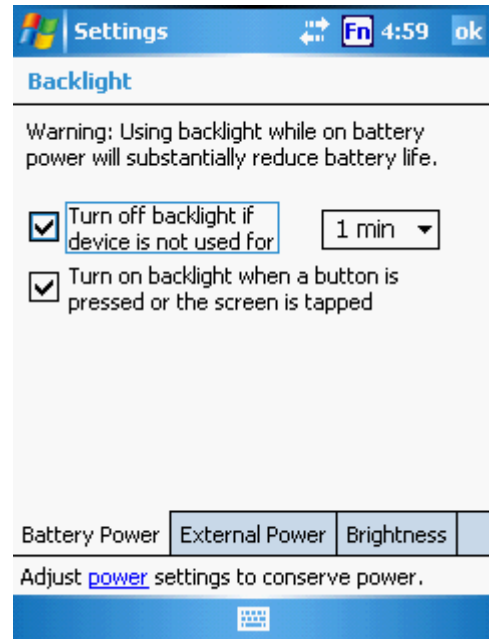

- In the Brightness tab, tap and drag the slider to choose a dimmer backlight when operating on battery power.

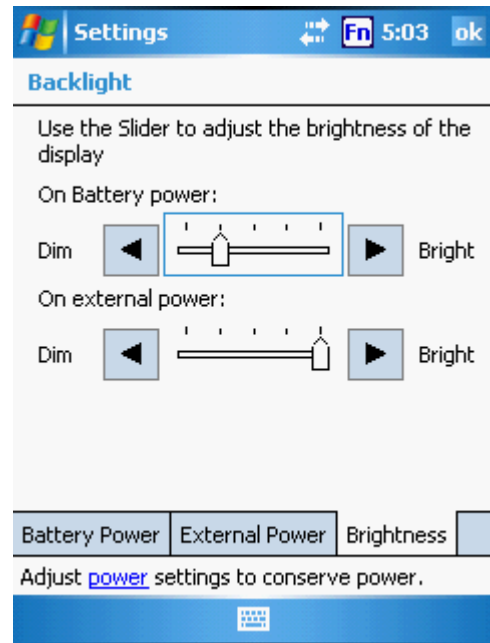

Viewing Flash Memory Files

The Flash Storage folder is a rewritable locations for programs or data files. The benefit of this feature is that files and programs saved in Flash Storage are unaffected by the PA600 power status.

To access the Flash Memory files:

1. Click My Device > Flash Storage

To transfer files to Device's Flash Memory:

1. Connect the device to your computer by Activesync.
2. On your computer's Activesync, click Mobile Device > Flash Storage.
3. Select the file that you want to transfer.
4. Drag the file from your terminal's flash storage folder to your computer's folder or drag the file from your computer's folder to the terminal's flash storage folder.

Performing a hardware reset

You may have to perform a reset if the device freezes (i.e., device no longer responds to the buttons on the screen).

A soft reset allows your device to get a fresh start, similar to rebooting a computer. This will restart your device and adjust memory allocation. All records and entries are retained after a soft reset. Unsaved data in open programs may in some cases be lost.

Performing a Warm Boot

1. Remove the stylus from its holder.
2. Lightly press the tip of the stylus to the reset button located on the rear of the PA600.

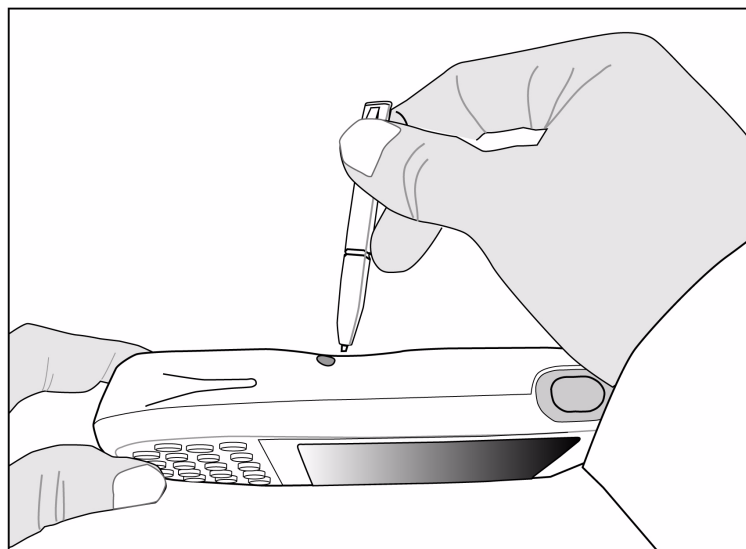
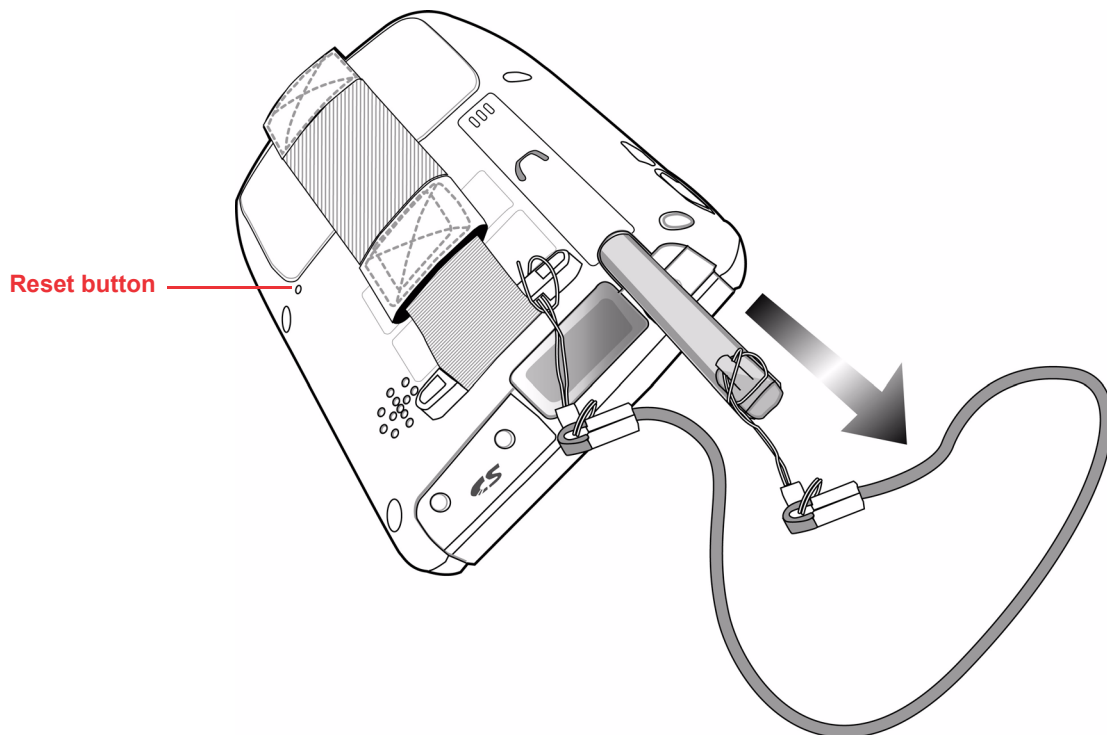

Performing a Cool Boot

A hard reset cuts off power to your device, erasing all records and entries, deleting all programs you have added, and restoring the device to default factory settings.

Never perform a hard reset unless a soft reset does not correct your problem. When you perform your next ActiveSync operation, you can restore any data that you previously synchronized to your computer or you can restore data that you backed up to a storage card.

NOTE: When you perform a hard reset, the date and time settings are not be retained. Formats, preferences, and other settings are restored to their default factory settings.

Method 1

Follow these instructions to perform a cool boot.

1. Press and hold the Func + Backspace key.

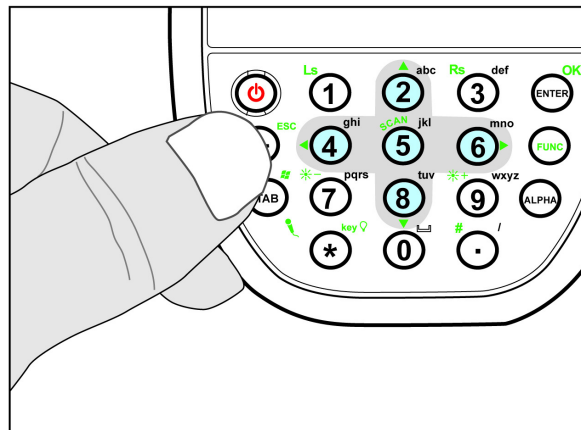

2. While holding the Func key and Backspace key, insert the tip of the stylus into the reset hole on the back of the PA600. Press and hold the reset button until you see the Unitech splash logo screen. Wait 5 seconds and then release the Func key and Backspace key.

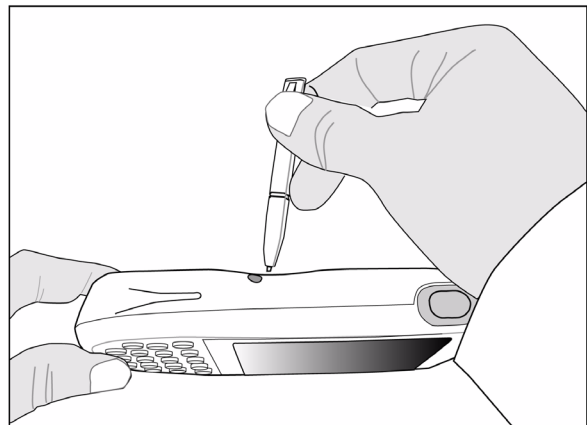

NOTE: The system is returned to the default settings. All registry settings and all files (include the hidden files) are returned to their original factory defaults

Method 2: Registry Cleanup

1. Press and hold the TAB key.

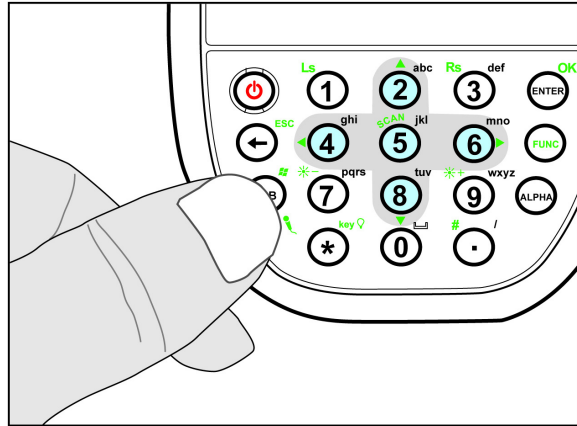

2. While holding the TAB key and Func key, insert the tip of the stylus into the reset hole on the back of the PA600. Press and hold the reset button until you see the Unitech splash logo screen appear. Wait for 5 seconds and then release the TAB and Func key.

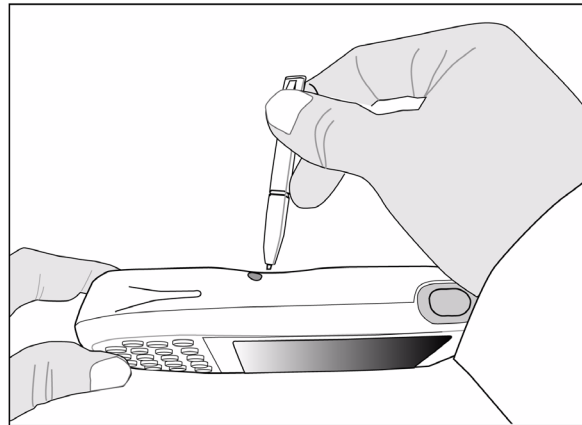

NOTE: All registry settings are returned to default settings. Applications and any data is retained. Files in the Flash Storage are retained.

System Specification

Processing/Memory	CPU	Intel PXA270 520MHz
	Memory	SDRAM:64MB Flash ROM:128MB
OS	Window Mobile 5.0 / Windows CE.NET 5.0	
Keypad	18-Key, including numeric key, alpha key and function key	
Display	240x320 QVGA, Color Transflective TFT, with Touch Screen & backlight	
Scanner	Laser Scan Engine, CCD Scan Engine as optional	
Indicator	Led, Vibrator	
Communication	USB Host & Client IrDA 1.2(SIR) GPRS (Data Only) 802.11b/g for power saving Bluetooth Bluetooth supports Bluetooth Printer, Bluetooth Modem, Bluetooth ActiveSync	
Audio	MIC Speaker Headset Connector Receiver	
Expansion Slot	SDIO slot	
Power Source	Main	3.7V 1950mAH Li-ion battery pack
	Backup	One rechargeable Ni-MH backup battery
Enclosure	Weight	Under 300g with battery & scan engine
	Dimension	Approximately L149.5 X H26.6 X W85mm
Environmental	Operating temperature	0 C~ 50 C
	Storage temperature	-20 C~ 60 C
	Relative Humidity	5% ~ 95%(non-condensing)
	Drop test to Concrete	4 feet
	Environmental Sealing	IP54
Models	GPRS + BT	
	802.11b/g + BT	
	BT Only	
Certification	CE, FCC, BSMI, VCCI, RoHS compliant	
Accessories	Desktop Cradle 4 slot Battery Charger	Vehicle Quick Charging Cable Holster
Software	Microsoft Visual Studio 2005 Microsoft Windows Mobile 5.0 SDK Unitech PA600 SDK VOIP (via 3rd party)	