



# PrintServer II

User and Reference Guide



Copyright © 2002 ZIH Corp.

This copyrighted guide and the label printers described herein are owned by Zebra. All rights are reserved. Unauthorized reproduction of the guide or the software in the label printer may result in imprisonment of up to one year and fines of up to \$10,000 (17 U.S.C.506). Copyright violators may be subject to civil liability.

IBM<sup>®</sup> is a registered trademark of IBM Corporation and TrueType is a registered trademark of Apple Computer, Inc.

Zebra<sup>®</sup>, Stripe<sup>®</sup>, ZPL<sup>®</sup>, and ZPL II<sup>®</sup> are registered trademarks of Zebra.

All other brand names, product names, or trademarks belong to their respective holders.

**Document Name: 45537LB-Rev6.pdf**

# Your Feedback Is Important

Your feedback helps us improve our documents to better serve you!

Please take a few minutes to evaluate your experience using this document.

## Product and Personal Information

1. What printer are you using? \_\_\_\_\_
2. What document are you using? \_\_\_\_\_
3. Have you ever worked with our product before? Yes No  
If Yes, how many \_\_\_years? \_\_\_months?
4. What is your education level? \_\_\_\_\_

## Document Usability

Check the rating that applies to your experience using this document:

Content	Excellent	Good	Poor
The information I needed was available.			
The information I needed was easy to find.			
The information and directions were clear.			
The illustrations were helpful.			
The document was arranged logically.			
The Table of Contents and Index were helpful.			
The Glossary was helpful.			
The level of information was appropriate for my technical expertise.			

## Additional Comments

Write any additional comments on the lines provided on the next page.





# Warranty Information

## **ZebraNet® PrintServer II**

Zebra warrants the ZebraNet PrintServer II against defects in material or workmanship for a period of three years from either (i) the date of shipment to you by Zebra, or (ii) the date of any resale by you to an end user, whichever is later. Proof of shipment date may be required to validate the warranty period. This warranty does not cover normal wear and tear, and shall be null and void if the equipment is modified, improperly installed or used, damaged by accident or neglect, or improperly installed or replaced by the user. To qualify for this warranty, the ZebraNet PrintServer II must be returned to the factory or other authorized service center.

ZEBRA'S SOLE OBLIGATION UNDER THIS WARRANTY SHALL BE TO FURNISH PARTS AND LABOR FOR THE REPAIR OR REPLACEMENT OF PRODUCTS FOUND TO BE DEFECTIVE IN MATERIAL OR WORKMANSHIP DURING THE WARRANTY PERIOD, OR ZEBRA MAY, AT ITS DISCRETION, ISSUE A CREDIT FOR ANY SUCH DEFECTIVE PRODUCTS IN SUCH AMOUNT AS IT DEEMS REASONABLE.

As a condition of this warranty, the user must: (a) obtain a Zebra Return Materials Authorization (RMA), which will include an RMA number that must be prominently displayed on the outside of the shipping container (returns without an RMA number will be rejected by Zebra and immediately returned to you, freight collect); (b) ship the Product being returned freight prepaid, to the authorized service location; and (c) include with the Product a written description of the claimed defect. Products returned should be packaged in the original packing and shipping container or comparable

container. In the event the Product is not so packaged or if shipping damage is evident, it will not be accepted for service under warranty. Surface transportation charges for the return of the Product to the customer shall be paid by Zebra within the 48 contiguous states and the District of Columbia. The customer shall pay shipping costs, customs clearance, and other related charges outside the designated area. If Zebra determines that the Product returned to it for warranty service or replacement is not defective as herein defined, the customer shall pay all costs of handling and transportation.

## **Warranty Exclusions and Conditions**

The above warranty is in lieu of all other warranties, expressed or implied, oral or written, statutory or otherwise, including any implied warranty of merchantability or fitness for a particular purpose. Zebra shall not be responsible for the specific application to which any Products are applied, including but not limited to compatibility with other equipment. All statements, technical information, and recommendations relating to Zebra Products are based on tests believed to be reliable but do not constitute a guarantee or warranty.

ZEBRA SHALL NOT, UNDER ANY CIRCUMSTANCES WHATSOEVER, BE LIABLE TO THE BUYER OR ANY OTHER PARTY FOR LOST PROFITS, DIMINUTION OF GOOD WILL, OR ANY OTHER SPECIAL OR CONSEQUENTIAL DAMAGES WHATSOEVER WITH RESPECT TO ANY CLAIM HEREUNDER. IN ADDITION, ZEBRA'S LIABILITY FOR WARRANTY CLAIMS SHALL NOT, IN ANY EVENT, EXCEED THE INVOICE PRICE OF THE PRODUCT CLAIMED DEFECTIVE, NOR SHALL ZEBRA BE LIABLE FOR DELAYS IN REPLACEMENT OR REPAIR OF PRODUCTS.

No salesperson, representative, or agent of Zebra is authorized to make any guarantee, warranty, or representation in addition to the foregoing warranty.

NO WAIVER, ALTERATION, ADDITION, OR MODIFICATION OF THE FOREGOING WARRANTY SHALL BE VALID UNLESS MADE IN WRITING AND SIGNED BY AN EXECUTIVE OFFICER OF ZEBRA.

## **Software License Agreement**

Software and documentation provided by Zebra are protected by the United States copyright law and international treaty, and therefore you must treat them like a book,

with the exception that you may make copies of the software to protect yourself against loss of the original.

Your right to use the software and documentation as described below is non-exclusive and non-transferable. Zebra retains ownership of the software and documentation and all other rights, title, and interest. The software and documentation may be used by any number of people and may be freely moved from one computer to another as long as there is no possibility of their being used by more than one person on more than one computer at the same time.

Machine readable files representing graphics or fonts that you have created independently may be converted to ZPL format files using the software, and such files may be used, copied onto diskettes or font cards, given away, or sold without paying license fees to Zebra. Pictorial or graphic images and any machine readable files representing them may be protected by United States copyright law and international treaty provisions, which prohibit you from transcribing or scanning such images or using, copying, or converting such files without permission of the copyright owner. You may not use this software in violation of U.S. copyright law or international treaty. By using this software, you agree to be bound by these terms.

Zebra warrants the software diskettes to be free of defects in material and workmanship for a period of 60 days from the date of purchase. In the event of notification within the warranty period of defects in material and workmanship, Zebra will replace the defective diskette or documentation. Zebra specifically disclaims all other warranties, expressed or implied, including but not limited to implied warranties of merchantability and fitness for a particular purpose. **IN NO EVENT WILL ZEBRA BE LIABLE FOR LOST PROFITS, LOST DATA, OR ANY OTHER INCIDENTAL OR CONSEQUENTIAL DAMAGES CAUSED BY ABUSE OR MISAPPLICATION OF THE SOFTWARE OR BY ITS USE IN VIOLATION OF THE U.S. COPYRIGHT LAW OR INTERNATIONAL TREATY.**

This product document refers to hardware and software products by their trade names. ZebraNet<sup>®</sup> is a trademark of Zebra. The PrintServer II is a product of Zebra. All other designations are trademarks or registered trademarks of their respective companies.





# Table of Contents

## Warranty Information

ZebraNet® PrintServer II .....	i
Software License Agreement .....	ii

## Preface .....

**ix**

Contacts .....	x
Support .....	x
Feedback .....	x
About this Document .....	xi
Document Conventions .....	xiii
Related Documents .....	xv

## 1 • Introduction .....

**1**

Overview .....	2
Illustration .....	2
Requirements .....	5
Software .....	5
Browser Support .....	5
Hardware .....	5
Compatibility .....	7
Installation Types .....	8
PSII Specifications .....	9



- 2 • Installation . . . . . 11**
  - External PSII . . . . . 12
    - Illustration . . . . . 12
  - Internal PSII . . . . . 16
    - Illustration . . . . . 16
  - ZebraNet Utilities . . . . . 19
  - ZebraNet View Java Applet . . . . . 23
- 3 • Getting Started . . . . . 27**
  - Before you begin . . . . . 28
  - Assigning an IP Address . . . . . 30
    - With Dynamic Host Configuration Protocol (DHCP) . . . . . 30
    - Without DHCP . . . . . 30
      - In a non-Windows environment . . . . . 33
  - Setting Alerts . . . . . 36
    - ZebraNet View . . . . . 36
    - ZebraLink . . . . . 38
  - Checking PSII Configuration Settings . . . . . 44
    - ZebraNet View . . . . . 44
    - Browser . . . . . 45
  - Setting up a ZebraNet Connect IP . . . . . 49
    - Windows NT 4.0/Windows 2000 . . . . . 49
    - Windows 95/98/Me . . . . . 50
    - IPX (NetWare) . . . . . 51
  - Enabling Protocols . . . . . 53
    - WebView . . . . . 53
    - ZebraNet View . . . . . 55
  - Defaulting the PSII . . . . . 57
    - WebView . . . . . 57
    - ZebraNet View . . . . . 58
    - Test Button . . . . . 59
- 4 • NetWare Print Configuration . . . . . 61**
  - Printing in PServer Mode . . . . . 62
- 5 • Printing Configurations . . . . . 65**
  - BSD (Berkeley Software Distribution)-Style Print Queue . . . . . 66
    - Configuring the Print Queue . . . . . 66
  - System V Queue Installation . . . . . 68

Configuring Operating System V Queue for ZebraNet Printing .....	68
Prerequisites .....	68
UNIX Configuration .....	68
<b>6 • Using Printing Protocols .....</b>	<b>71</b>
IPP .....	72
FTP .....	73
<b>A • PrintServer II .....</b>	<b>75</b>
PSII Features .....	76
Status and Configuration .....	76
Print Server Status .....	84
Reset .....	86
Restore .....	87
<b>B • ZebraLink .....</b>	<b>89</b>
WebView .....	90
Home Page .....	90
Alert Setup .....	100
Zebra BASIC Interpreter (ZBI) .....	105
<b>C • ZebraNet Utilities .....</b>	<b>107</b>
ZebraNet View .....	108
ZebraNet Alert .....	111
ZebraNet Alert Using SNMP .....	112
Sending Email to Your Zebra Printer .....	113
Open Alert .....	117
ZebraNet Connect .....	119
ZebraNet View Java Applet .....	120
<b>Hardware Troubleshooting .....</b>	<b>123</b>
Troubleshooting the PSII .....	124
<b>Frequently Asked Questions .....</b>	<b>127</b>
FAQs .....	128
<b>Glossary .....</b>	<b>133</b>





# Preface

The Preface discusses the topics and illustrates standards that are used throughout this guide.

## Contents

Contacts .....	<b>x</b>
About this Document .....	<b>xi</b>
Document Conventions .....	<b>xiii</b>
Related Documents .....	<b>xv</b>

## Contacts

You can contact Zebra, USA at any of the following:

**Visit us at:** <http://www.zebra.com>

**Our Mailing Address:**

**Zebra**

333 Corporate Woods Parkway  
Vernon Hills, Illinois 60061.3109 U.S.A  
Telephone +1 847.634.6700  
Facsimile +1 847.913.8766

**Zebra Technologies Europe Limited**

Zebra House  
The Valley Centre, Gordon Road  
High Wycombe  
Buckinghamshire HP13 6EQ, UK  
Telephone +44 (0)1494 472872  
Facsimile +44 (0) 1494 450103

## Support

You can contact Zebra support with any questions or problems with your ZebraNet PrintServer II (PSII):

**Support email:** <http://support.zebra.com>

**Telephone:** +1.847.913.2259

## Feedback

Be sure to complete the feedback form located at the beginning of this guide.

# About this Document

The *ZebraNet PrintServer II User and Reference Guide* consists of these chapters:

Title	Content Description
<i>Introduction</i>	This chapter provides a high-level overview of the ZebraNet PrintServer II (PSII), installation instructions, standard network configurations, and how to work with PSII.
<i>Installation</i>	This chapter provides information on how to install PSII (external and internal) and the ZebraNet Utilities.
<i>Getting Started</i>	This chapter provides you with information on how to work with the most frequently used PSII features.
<i>NetWare Print Configuration</i>	This chapter provides you with instructions on how to configure Novell's NetWare for printing to PSII.
<i>Printing Configurations</i>	This chapter provides information and instructions on configuring your printer for remote BSD-style LPD printing on the UNIX operating system.
<i>Using Printing Protocols</i>	This chapter provides information and steps to set up your PSII to support Internet Printing Protocol (IPP).
<i>PrintServer II</i>	This appendix provides you with details on the most commonly used PSII features.
<i>ZebraLink For ZebraLink-enabled printers.</i>	This appendix provides you with detailed information that allows you to use the enhanced functionality of your ZebraLink-enabled printer with the PSII.
<i>ZebraNet Utilities</i>	This appendix provides you with details on ZebraNet Utilities, the software suite of printer administration tools that complements and enhances both ZebraLink and the ZebraNet family of connectivity products.

---

<i>Hardware Troubleshooting</i>	This section provides you with solutions to known issues.
<i>Frequently Asked Questions</i>	This section is a compiled group of frequently asked questions (FAQs) about PSII.
<i>Glossary</i>	This section is a glossary of terms that are specific to the PSII.

---



# Document Conventions

The following conventions are used throughout this document to convey certain information:

**About this Chapter Sections** These sections list and describe each main section of the chapter, including the initial page numbers of those sections. These sections primarily serve as hyperlink components for the Adobe Acrobat .pdf version of this guide.

**Alternate Color** (online only) Cross-references contain hot links to other sections in this guide. If you are viewing this guide online in .pdf format, you can click the cross-reference (royal blue text) to jump directly to its location.

**Command Line Examples** All command line examples appear in *Courier* font. For example, you would type the following to get to the Post-Install scripts in the `bin` directory:

```
Ztools
```

**Files and Directories** All file names and directories appear in *Courier* font. For example, the `Zebra<version number>.tar` file and the `/root` directory.

**Warning, Caution, Important, Note, Tools, and Example** These topics are defined in the following example:



**Warning** • Advises you that failure to take or avoid a specific action could result in physical harm to you or the hardware.



**Caution** • Advises you that failure to take or avoid a specified action could result in loss of data.



**Important** • Provides information that is essential to the completion of a task.



**Note** • Indicates neutral or positive information that emphasizes or supplements important points of the main text.



**Tools** • Identifies the tools you need to accomplish a task.



**Example** • Provides an example, often a scenario, to better clarify a section of text.

**Illustration Callout Instruction** Illustration callout instructions are used when an illustration contains either information about a dialog box or step(s) to accomplish in a dialog box.

This illustration callout instruction identifies a section of the dialog box, and the other callout shows steps to follow:

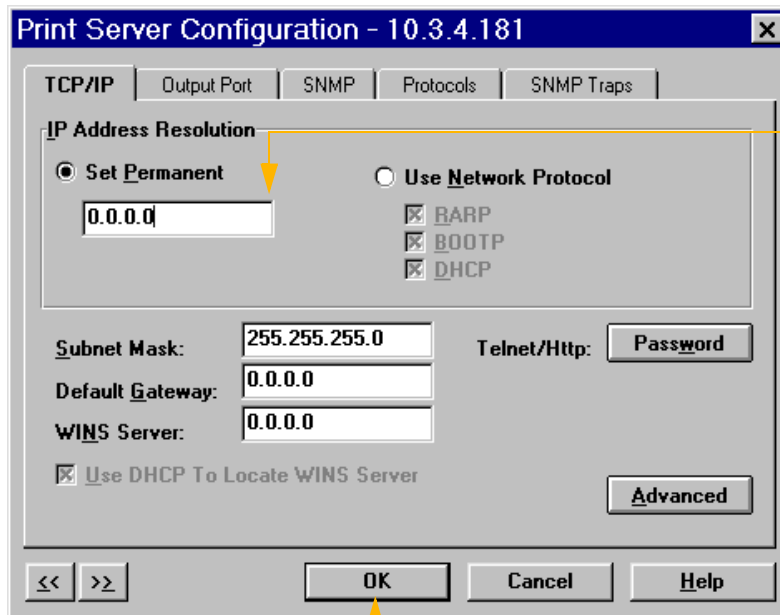

In the Set Permanent text-box, type in the print server's IP address.

When you are finished, click OK.

## Related Documents

In addition to the *ZebraNet PrintServer User and Reference Guide*, the following documents might be helpful references while using PSII:



**Note** • Most of these documents are available on our Web site.

- *Wireless Card Socket Option (WCSO) Install and Users Guide*
- *The ZebraLink Solution Application White-paper*
- *ZBI Guide*
- *ZPL II<sup>®</sup> Programming Guide Volume One: Command Reference for X.10*
- *ZPL II<sup>®</sup> Programming Guide Volume Two: The X.10 Environment*
- *EPL2 Programmer's Manual*
- *Line Mode Programmer's Manual*



**Preface**

Related Documents

# CHAPTER 1

## Introduction

This chapter provides a high-level overview of the PSII device, installation instructions, standard network configurations, and how to work with PSII.

### Contents

Overview .....	2
Requirements .....	5
Compatibility .....	7
Installation Types.....	8
PSII Specifications.....	9

## Overview

The PSII is an optional factory- or field-installed device that connects the network and your Zebra printer. If your printer is ZebraLink-enabled, PSII provides you with a browser user-interface for printer and PSII settings. If your printer also has ZebraNet Utilities, you have even more functionality. For details, see [ZebraNet Utilities on page 3](#).



**Important** • You can download the most recent version of ZebraNet Utilities from our Web site: [www.zebra.com](http://www.zebra.com).

## Illustration

This illustration shows the flow of all the components that work with PSII. The table that follows this illustration identifies the components and how they enhance each respective device:

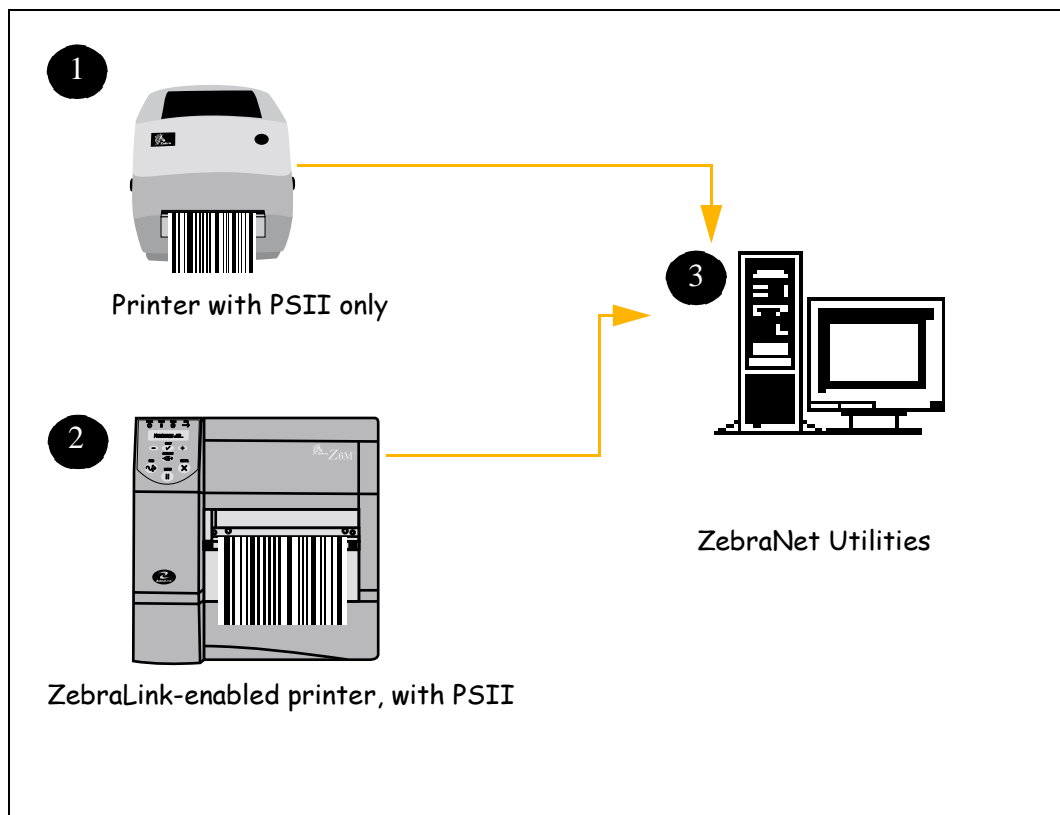

Components	Description
<p><b>Printer with PSII only</b></p> <p>1</p>	<p>PSII gives your printer these features:</p> <ul style="list-style-type: none"> <li>• allows the remote monitoring and configuration capability of the PSII using a browser.</li> <li>• allows you to send unsolicited printer status messages via email-enabled devices.</li> </ul>
<p><b>ZebraLink-enabled printer with PSII</b></p> <p>2</p>	<p>A ZebraLink-enabled printer with PSII gives you all the above-mentioned features (WebView and Alert), plus these features:</p> <ul style="list-style-type: none"> <li>• <i>ZBI</i>™ (Zebra BASIC Interpreter)—programming language that works with ZPL II to control and interpret incoming text and data. This provides you with the ability to create stand-alone applications using a printer and peripheral devices, such as a scale or a scanner, without needing a PC host. Internet-aware ZBI then transmits data captured by these devices over your LAN, WAN, or wireless network (adding the Wireless Card Socket Option allows these features to work over a wireless network) via email or TCP/ IP messaging.</li> </ul> <p><b>NOTE</b> • PSII can be either field- or factory-installed for additional features. For details, see <a href="#">Installation Types on page 8</a>.</p>
<p><b>ZebraNet Utilities</b></p> <p>3</p>	<p>ZebraNet® Utilities is a suite of software programs that work with PSII and enhance the features of ZebraLink resident within ZPL-based printers. The features include</p> <ul style="list-style-type: none"> <li>• <i>ZebraNet Alert</i> lets you configure multiple event alerts per device with different alerts going to different people. You are notified of alerts from either visual or audio cues. You can also generate advanced alert reports.</li> </ul>

<b>Components</b>	<b>Description</b>
	<ul style="list-style-type: none"><li>• <i>ZebraNet Connect IP</i> lets you, with Windows, enable simple printer selection of an IP addressable printer.</li><li>• <i>ZebraNet View</i> allows you to locate printers automatically. ZebraNet View searches on parameters such as IP address, subnet, printer model, printer status, and many other user-defined characteristics. It also offers powerful device management capabilities.</li><li>• <i>ZebraNet View Java Applet</i> is a Java-based version of the popular ZebraNet View. It gives you ZebraNet View capabilities in a non-Windows environment.</li></ul>

---



# Requirements

This section lists the minimum requirements for PSII, which include software, browser support, and hardware.

## Software

These are the platforms supported by ZebraNet Utilities:

---

Windows™ NT®, 95, 98, 2000, Me

Novell® Netware®

---

The ZebraNet View Java Applet is supported by any Java-enabled browser:

---

UNIX®

Linux

---

## Browser Support

---

Internet Explorer 4.0+

Netscape Navigator 4.08+

Any browser that is HTML 1.1 compliant

---

## Hardware

These are the minimum hardware requirements:

Printers	External	Internal Field Upgrade	Internal Factory
<i>Xi Series (XiII and XiIII)</i>	•	•	•
R140	•	•	•

---

<b>Printers</b>	<b>External</b>	<b>Internal Field Upgrade</b>	<b>Internal Factory</b>
PAX Series	•	•	•
Z-Series®	•		
Stripe® Series	•		
105SL	•	•	•
105 Se/160S	•		
2746	•		
2746e	•		•
2684	•		
DA402, T402	•		
2844 (EPL)	•		•
2844 (ZPL)	•		•*
Ht-146	•		•*
2824	•		•

---

\* future releases

# Compatibility

This section identifies the various components that are compatible with PSII.

**ZebraNet Wireless Card Socket Option (WCSO)** PSII is fully compatible with WCSO.

**Software** HP JetAdmin, HP Web JetAdmin™, and HP OpenView™ all work with PSII.

# Installation Types

PSII can be factory- or field-installed, as follows:

**Factory** Factory-installations are for new Zebra printers that are built with the internal PSII option.

**Field** Field-installations are for Zebra printers already in the field that do not have the PSII device installed. The PSII option can be installed on existing printers, as follows:

- External PSII—attaches to the printer parallel port
- Internal PSII—for the appropriate Zebra printers, this option connects directly to the main logic board

# PSII Specifications

**Network Connection** 10BASE-T UTP RJ45 connection. Auto senses IEEE- 802.3, Ethernet II, IEEE- 802.2, and IEEE 802.2/SNAP frame formats

**Printer Connection** Bi-directional, IEEE- 1284 Centronics parallel port

**User Interface** Activity indicator: bi-color display of operational status; test button: diagnostic test and configuration printing

**Size (external ZebraNet PrintServer II)** Length: 3.6" / 91.4 mm, Width: 2.5" / 63.5 mm, Height: 0.8" / 20.3 mm

**Weight (external ZebraNet PrintServer II)** .5 oz / 71 g

**Power** Maximum 250mA at 5.25VDC; power provided by the printer (Centronics pin 18, 5VDC at 200mA)

**Environment** Operating Temperature: 0° to 104°F (0° to 40°C); Storage Temperature: -4° to 140°F (-20° to 60°C); Operating Humidity: 25 to 85% non-condensing

**Agency Approvals** IEC950; Canadian DOC; FCC Class B; C. I. S. P. R. 22-B; EN50082-1: 1997; and AS/NZS3548

**Warranty** Three years



## CHAPTER 2

# Installation

This chapter provides information on how to install PSII (external and internal) and the ZebraNet Utilities.

### Contents

External PSII .....	12
Internal PSII.....	16
ZebraNet Utilities.....	19
ZebraNet View Java Applet.....	23

## External PSII

This section provides you with an illustration of the external PSII and the steps required for its installation.

### Illustration

This illustration shows a visual of an external PSII. The callouts identify the important components:

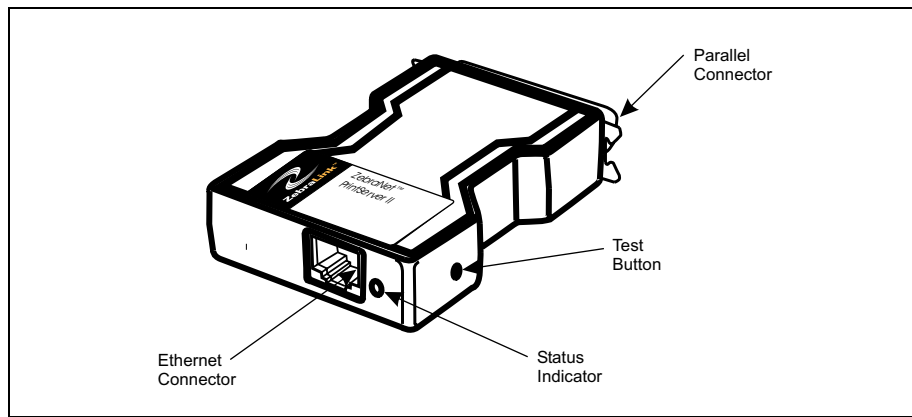

**Note** • When necessary, refer back to this illustration during the installation steps.

### To install an external PS II, complete these steps:

- 1 Turn off the printer.
- 2 On the back of the printer, insert the PSII device into the parallel port.



This illustration calls out the location of the parallel port and provides an enlarged illustration of the parallel port:

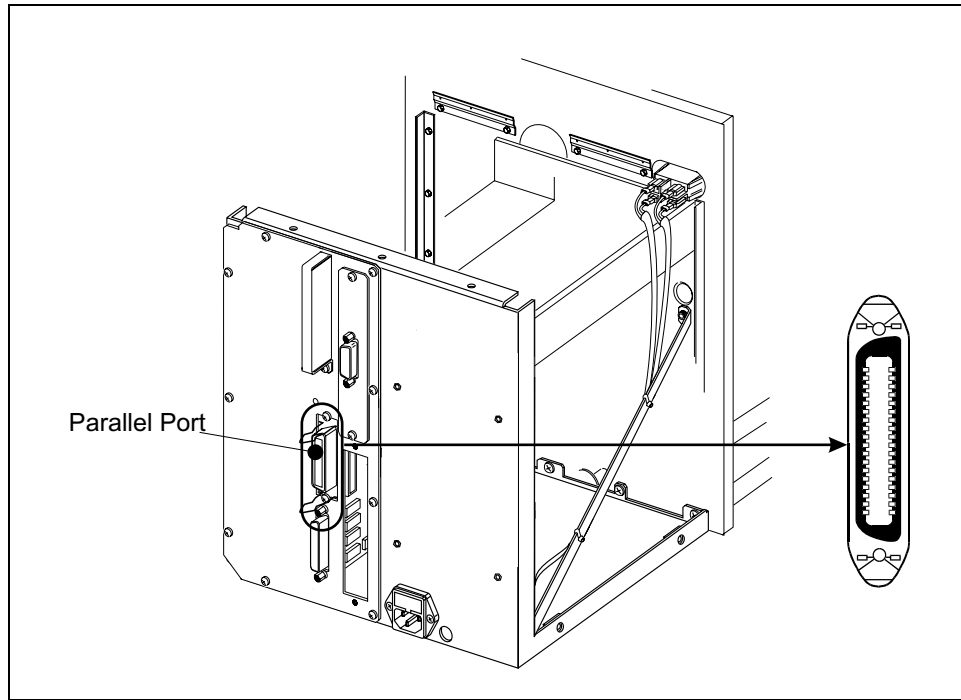

- 3 Secure the wire locks.
- 4 On the back of the PSII, insert a live 10BASE-T cable into the Ethernet connector.
- 5 Turn on the printer.

A red status indicator blinks during the Power On Self Test (POST) and changes to green when the initialization is finished.

The **Test** button is a small hole on the PSII device. To press it, you need to insert something small into the hole, like a paperclip.

- 6 Press the **Test** button located on the side of the PSII. This prints out a PSII configuration label.



**Important** • DPI and your firmware version:

- For printers with firmware version 7.01 and higher, regardless of the dpi, a 2-inch (5 cm) label prints
- For printers with firmware version 7 and lower, see the table that follows.

This table shows you how to determine the minimum label width needed to print a PSII configuration label for printers with firmware version 7 or lower:

DPI	Inches
600	1.25
300	2.50
200	3.69
150	5.0

This is an example of a PSII configuration label. The callouts identify the settings you need to know. The table following the illustration callout provides a description of each callout.

```

TCP/IP
  ENABLED
  10.3.4.102
  255.255.255.0
  10.3.4.1
  Enabled
  STATUS
  ADDRESS
  SUBNET MASK
  DEFAULT GATEWAY
  TIMEOUT CHECKING

NETWORK
  ENABLED
  Ethernet 802.3
  Unknown
  STATUS
  FRAME FORMAT
  MODE

GENERAL
  1928107
  0040681D6BAB
  6.30 (A021A)
  SERIAL NUMBER
  HARDWARE ADDRESS
  FIRMWARE VERSION

ERROR
  None
  Error reading from Telnet
  None
  GENERAL
  TCP/IP
  NETWORK

JET ADMIN
  ENABLED
  STATUS

PORT CONFIGURATION
  Online
  ZTC 140XiIII-200dpi
  None
  PORT NAME
  PRINTER STATUS
  CONNECTED TO
  ERROR

ZebraNet™ PRINT SERVER CONFIGURATION
FIRMWARE IN THIS PRINTER IS COPYRIGHTED
  
```

Callout	Description
1	This shows the IP address, subnet mask, and default gateway of the PSII device. If the IP address is set at 0.0.0.0, you need the serial number (in callout 3) to set the IP address.
2	This shows all the Novell settings.
3	This shows the serial number, hardware address (MAC address), and firmware version of the PSII device.

---

## Internal PSII

This section provides you with an illustration of an internal PSII and steps on how to install it in the Zebra *Xii*, *Xiii*, *105SL*, and *PAX-Series* printers.



**Important** • It is recommended that this installation be performed by a qualified service technician. The service technician must follow these step-by-step procedures.

### Illustration

This illustration provides you with a visual of an internal PSII. The callouts identify the important components:

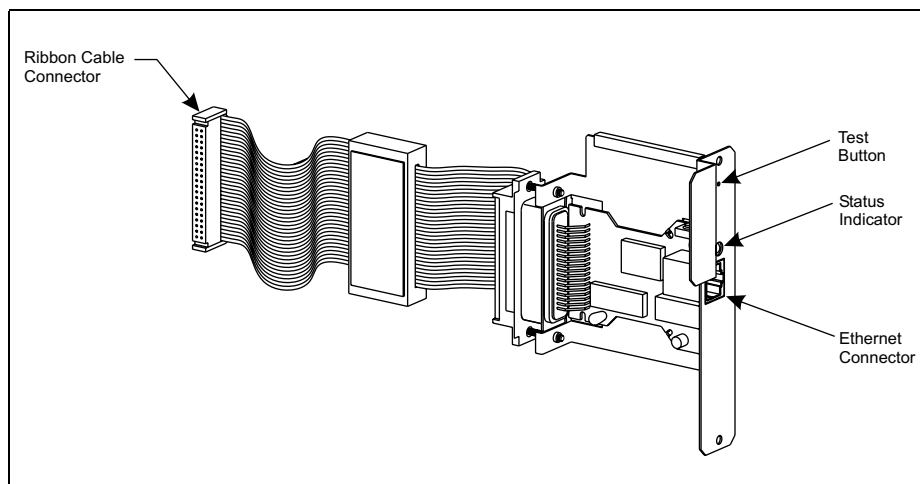

**Note** • When necessary, refer back to this illustration during the installation.



**Tools** • These are the tools you need for the installation:

- #1 Phillips screwdriver
- 3/32" Allen wrench



**Caution** • Printer electronics are susceptible to static discharge. Wear an anti-static wrist strap and attach it to the printer chassis when performing installations.

**To install an internal PSII, complete these steps:**

- 1 Turn off the printer and disconnect the AC power cord.
- 2 On the back of the printer, remove the two screws and the blank cover plate positioned next to the main RS-232 and parallel interface connectors.
- 3 To remove the side panel:
  - For the *XII*-, *XIII*-Series, and *105SL*, remove the screws and remove the left side panel.

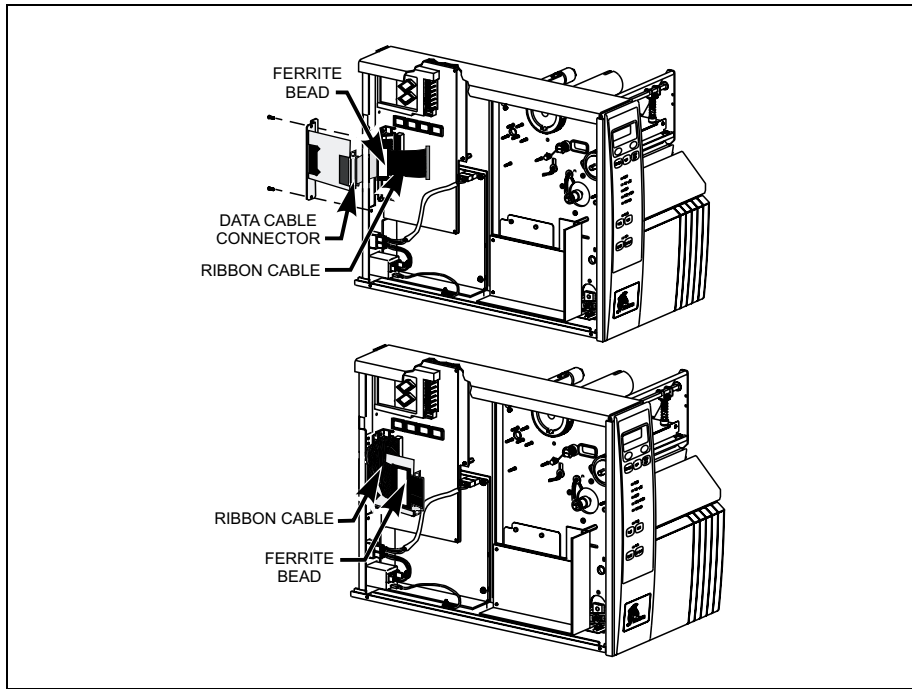

- For the PAX-Series, access the electronics by removing the mounting screws from the printer's PCB access panel and sliding the panel out.

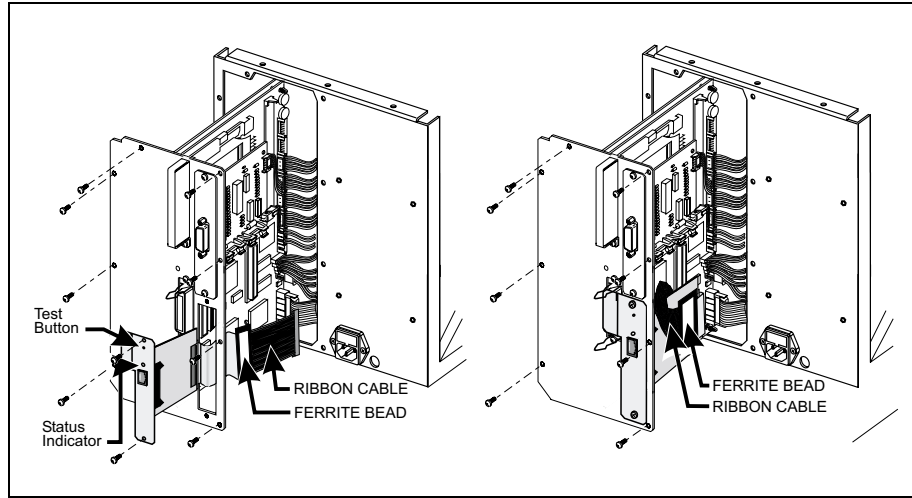

**Note** • The parallel port on the back of the printer is not operational when the internal PSII is installed. The hardware of the PSII mounting bracket covers the parallel port.

- 4 Through the mounting slot, insert the ribbon cable and PSII.
- 5 Fold the cable and the ferrite bead back over the mounting bracket, and connect the ribbon cable connector into the keyed Interface Data Cable Connector (J4) on the main logic board. Secure the PSII interface board in place with the cover plate screws that you removed early in this step sequence.
- 6 Confirm that all small cable connectors are tight.
- 7 Reinstall the PAX-Series PCB access panel or the left side-panel of the XiII and XiIII-Series printers that you removed earlier in this step sequence.
- 8 This kit includes a label printed with the Ethernet MAC hardware address for the PSII. Remove the backing from the label and affix it to the back of the printer.
- 9 Reconnect the AC power cord and turn the printer on.
- 10 Consult your System Administrator before configuring the PSII for your network! To establish the network connection, refer to the section applicable to your network type.

# ZebraNet Utilities

The ZebraNet Utilities is a software suite consisting of tools to assist you with the configuration of the PSII device, which gives you the flexibility to make changes to settings, track errors, and more.

If you want to be certain you have the most recent version of the ZebraNet Utilities, you can visit our Web site and download the most recent version.

For more details, see [Overview on page 2](#) or [ZebraNet Utilities on page 107](#).



**Note** • Contact your System Administrator before installing this software. You must have Administrator rights on your network to install most of these utilities.

## To install the ZebraNet Utilities, complete these steps:

The steps that follow reflect the steps and dialogs for a *typical* installation. If you plan to conduct a *custom* installation, the dialogs you encounter or see will differ from those in this step sequence.

- 1 Insert the CD-ROM into the drive.



**Important** • Is AutoPlay enabled on your computer?

- **Yes.** Your computer automatically launches the installation.
- **No.** You need to navigate to the Software>ZebraNet Util>setup.exe on the CD-ROM and manually launch the installation.

- 2 Click **Next>**.

This illustration shows the dialog box that lets you select the utilities that you want to install:

Each of these has drop-down menus to choose from.

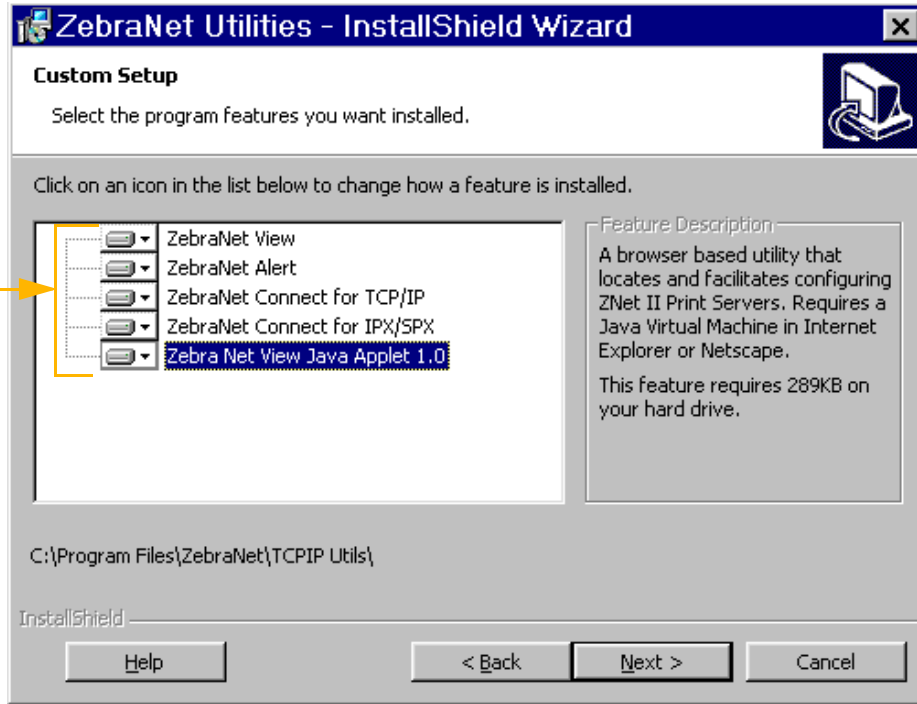

**Important** • If you installed ZebraNet View Java Applet, you must complete the installation steps for [ZebraNet View Java Applet on page 23](#).

- 3 In the *ZebraNet Utilities dialog*, select the features you want to install and click **Next>**.



This illustration gives you the chance to reset your installation settings:

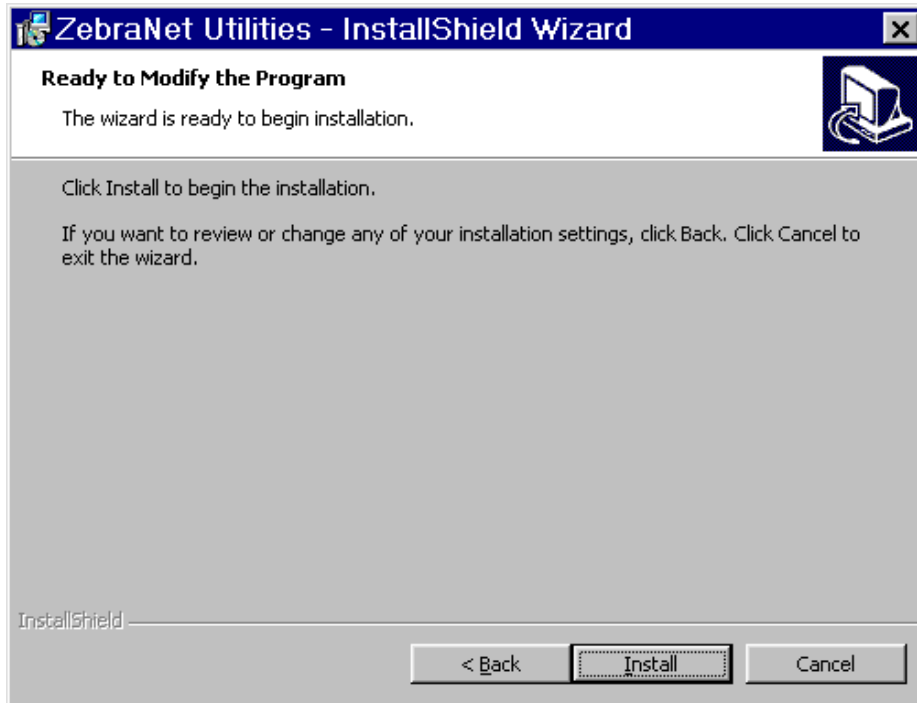

- 4 In the *ZebraNet Utilities* dialog, you have the option to review and make any changes to your installation settings. When you are satisfied with your installation settings, click **Install**.

When the installation is complete, this dialog opens:

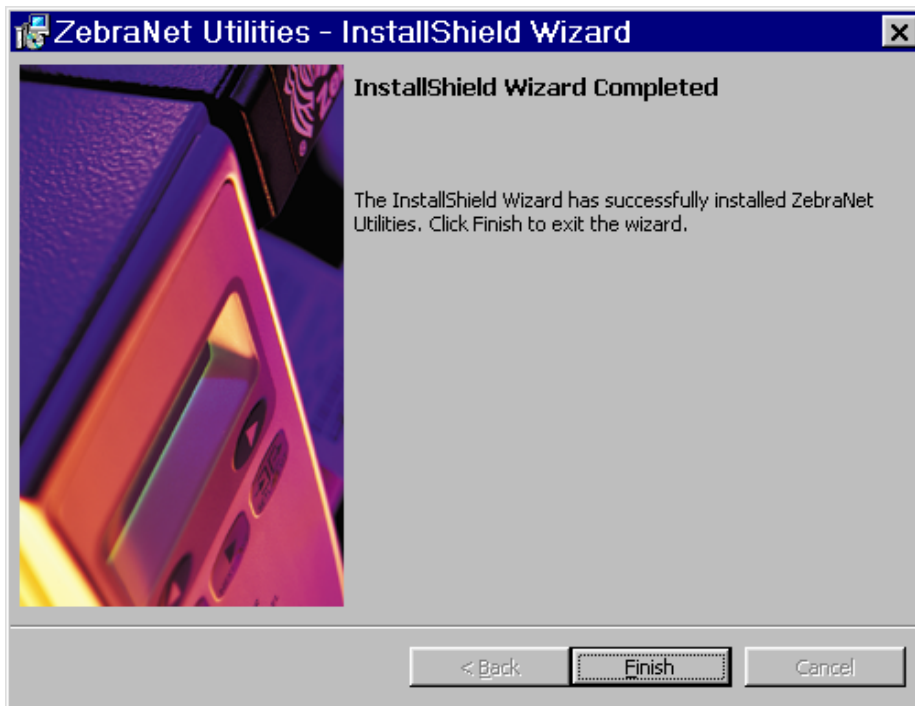

**5** Click Finish.



**Important** • When the installation is complete, you need to restart your system for the changes to take place.

# ZebraNet View Java Applet

If you selected ZebraNet View Java Applet when you were installing the ZebraNet Utilities, you need to complete a few installation steps to work with this utility.

## To install ZebraNet View Java Applet, complete these steps:

- 1 From the task bar, select Programs>ZebraNet Utilities>ZebraNet View Java Applet 1.0.

This *Security Warning* dialog opens:

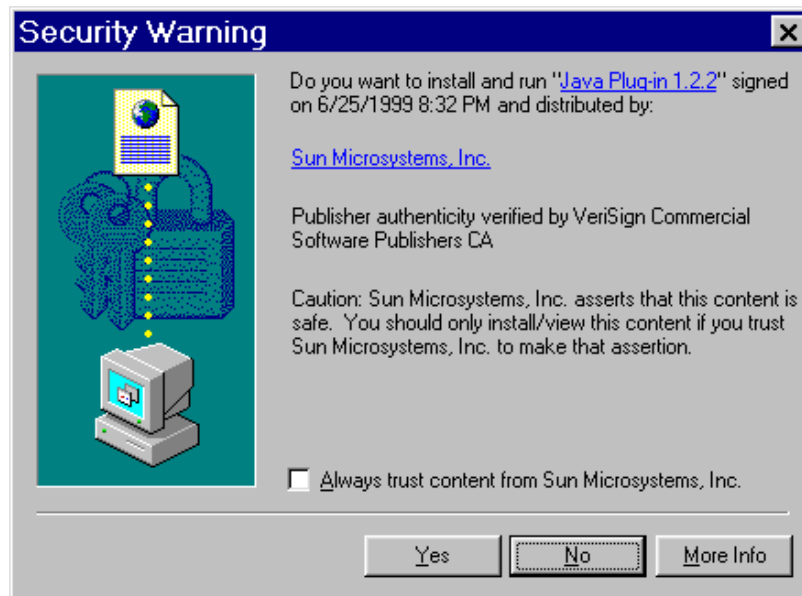

- 2 To begin the installation, click **Yes**.

The *Select Java Plugin Installation* dialog opens:

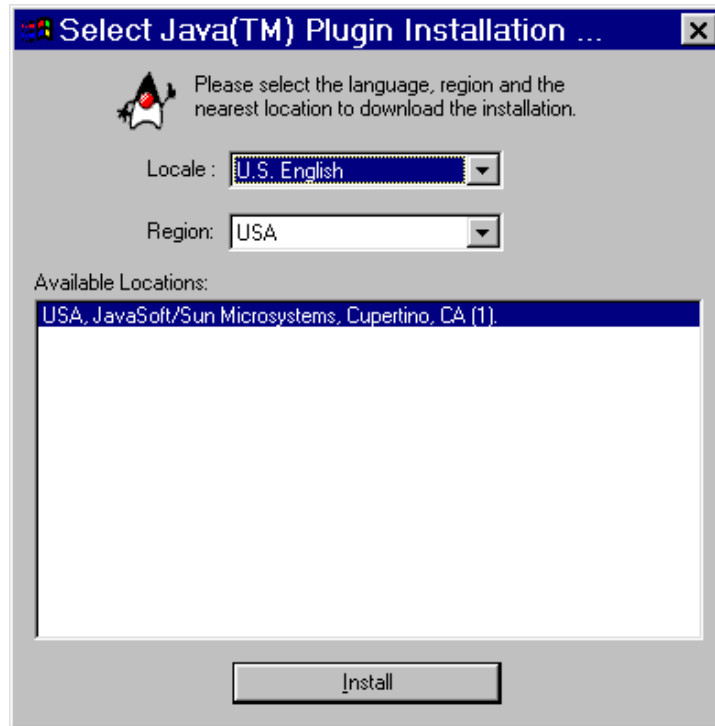

- 3 Make the selections that apply to your environment, and click **Install**.

The *Software License Agreement* opens.

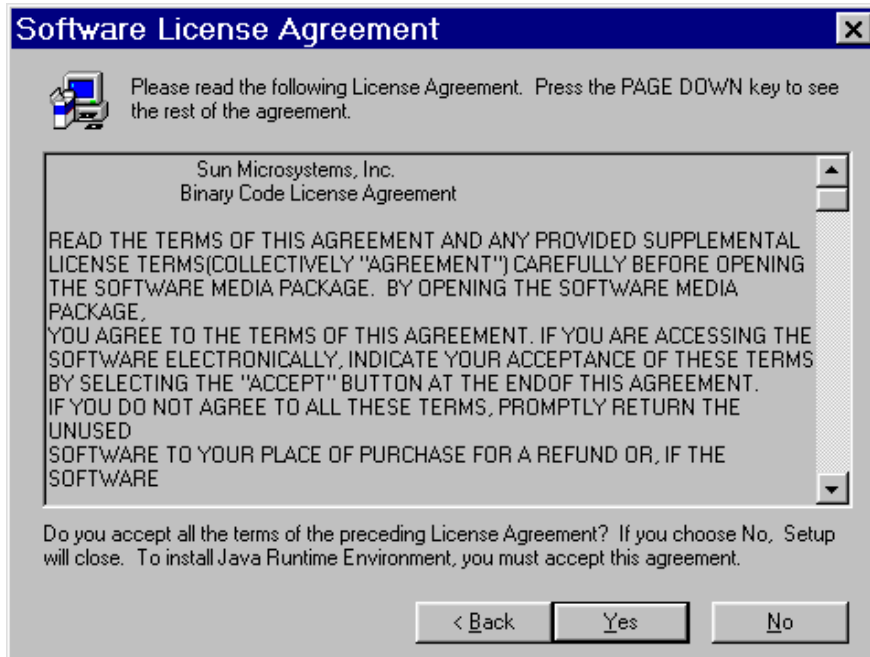

- 4 Read the License Agreement. To continue with the installation, click Yes.
- 5 When the installation is complete, click OK.

The Java page opens:

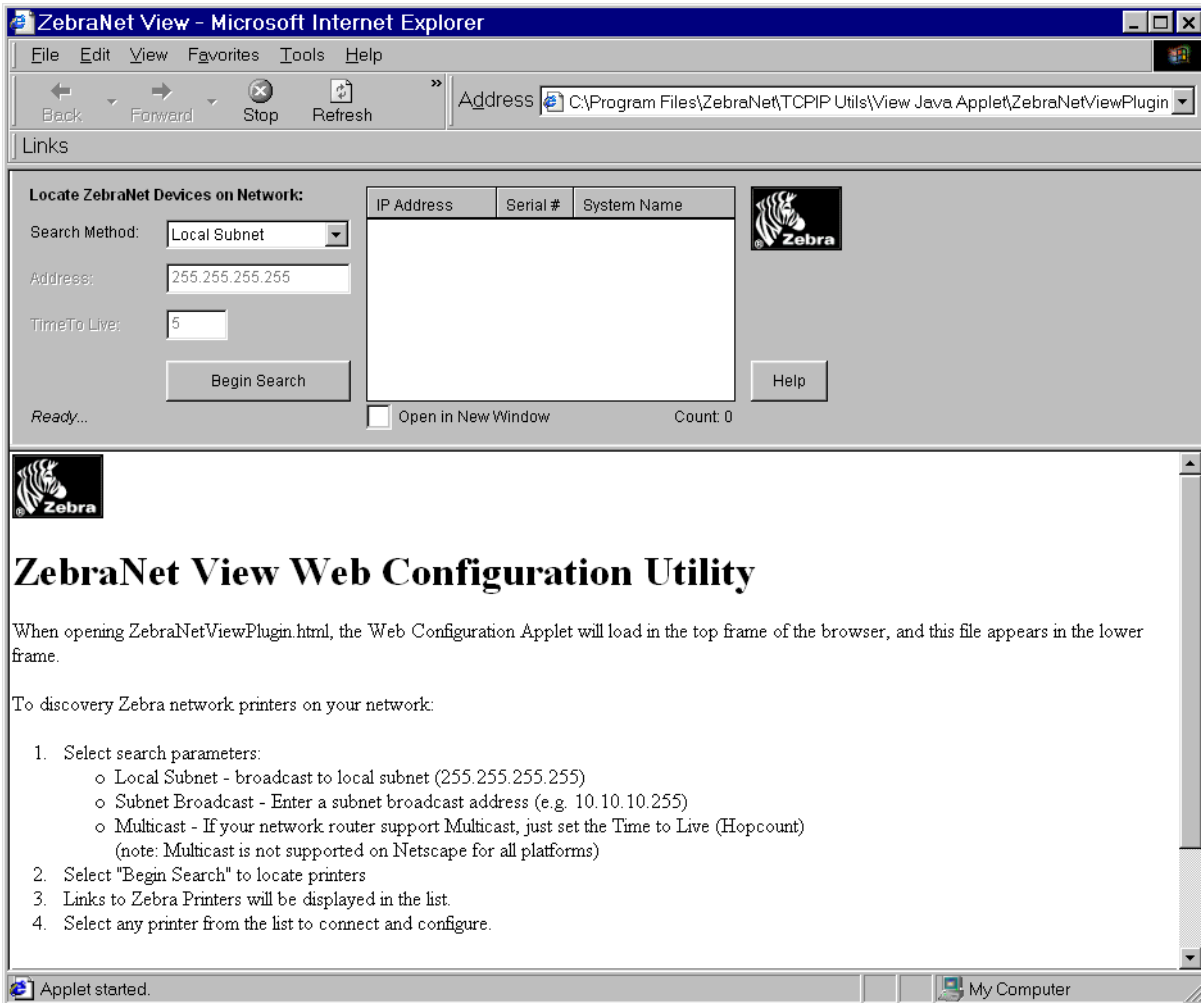

- 6 You have these options:
  - To work with this utility, see [ZebraNet View Java Applet on page 120](#).
  - To close the utility, click the **X**.



## **Installation**

ZebraNet View Java Applet

## CHAPTER 3

# Getting Started

This chapter provides you with information and procedures for working with the most frequently used PSII features.

### Contents

Before you begin . . . . .	28
Assigning an IP Address . . . . .	30
Setting Alerts . . . . .	36
Checking PSII Configuration Settings . . . . .	44
Setting up a ZebraNet Connect IP . . . . .	49
Enabling Protocols . . . . .	53
Defaulting the PSII . . . . .	57

## Before you begin

PSII offers many features, but how you access and work with them is dependent on your environment. Before you begin, you need to get information from the PSII configuration label.



**Important** • Make sure the printer is turned off.

### To print a PSII configuration label, complete these steps:

- 1 Turn on the printer and let it complete its power-up cycle.
- 2 Let the PSII complete its POST cycle.

The **Test** button is a small hole on the PSII device. To press it, you need to insert something small into the hole, like a paperclip.

- 3 When the first few steps are done, press the **Test** button and hold it in for a few seconds before you release it.



A PSII configuration label prints. Your configuration label looks similar to this:

```
TCP/IP
  ENABLED
  10.3.4.102
  255.255.255.0
  10.3.4.1
  Enabled
  STATUS
  ADDRESS
  SUBNET MASK
  DEFAULT GATEWAY
  TIMEOUT CHECKING

NETWARE
  ENABLED
  Ethernet 802.3
  Unknown
  STATUS
  FRAME FORMAT
  MODE

GENERAL
  1928107
  0040681D6BAB
  6.30 (A021A)
  SERIAL NUMBER
  HARDWARE ADDRESS
  FIRMWARE VERSION

ERROR
  None
  Error reading from Telnet
  None
  GENERAL
  TCP/IP
  NETWARE

JET ADMIN
  ENABLED
  STATUS

PORT CONFIGURATION
  Online
  ZTC 140XiIII-200dpi
  None
  PORT NAME
  PRINTER STATUS
  CONNECTED TO
  ERROR

ZebraNet™ PRINT SERVER CONFIGURATION
FIRMWARE IN THIS PRINTER IS COPYRIGHTED
```

4 From the configuration label, you need to get these numbers:

For details on getting these numbers, see [page 15](#).

- ADDRESS (IP address)
- SUBNET MASK
- DEFAULT GATEWAY
- SERIAL NUMBER
- HARDWARE ADDRESS (MAC address)

5 On the configuration label that prints out for your PSII device, circle the above-mentioned settings. You can now proceed to [Assigning an IP Address on page 30](#).

## Assigning an IP Address

Before you can begin working with PSII, you must get or assign an IP address for the PSII device.



**Important** • Throughout the step sequence in this chapter, there are some features that require the default User ID and/or default password. If you are prompted, these are the defaults:

- **User ID:** admin
- **Password:** 1234

### With Dynamic Host Configuration Protocol (DHCP)

If your network uses DHCP, the necessary configuration information must be set on the PSII when the unit initially connects to the network and is turned on.



**Note** • Check with your Network Administrator to see whether your network uses DHCP.

### Without DHCP

If your network does not use a dynamic IP addressing system (such as DHCP), you need to set the IP address of the PSII device.

### ZebraNet View

ZebraNet View is the Windows-based print server management and configuration utility that came with your PSII.



**Important** • The remaining sections are dependent on the successful installation of ZebraNet Utilities, which you should have completed on [page 19](#).

## To assign an IP address using ZebraNet View, complete these steps:

- 1 From the task bar, select Start>Programs>ZebraNet Utilities>ZebraNet View.



**Important** • On the illustration that follows, take note of the H/W address column and Serial # column. Compare what you see in ZebraNet View with the configuration label you printed out.

The *ZebraNet View* dialog opens:

System Name	IP Address	H/W Address	Serial #	Subnet Mask	Default Ga...	Product Type	Product #	Datecode	Status
Focus	10.3.4.102	0040681D6BAB	1928107	255.255.255.0	10.3.4.1	ZebraNet PrintServer	46686	A021A	Warning
Testlab-107	10.3.4.138	0040681D935F	1938271	255.255.255.0	10.3.4.1	ZebraNet PrintServer	46687	A242A	Good
XML/ZPL Hybrid	10.3.4.179	0040681D935A	1938266	255.255.255.0	10.3.4.1	ZebraNet PrintServer	46687	A021A	Good

- 2 Compare the H/W Address or Serial Number on the PSII configuration label with the H/W Address column on the screen to find the PSII you are working with.
- 3 When you locate your PSII, select it.
- 4 From the menu bar, select PrintServer>Configuration.



**Important** • If the PSII does not have an IP address, it shows in the main screen with an IP of 0.0.0.0. If, after 2 minutes, you do not assign an IP Address, the PSII defaults to IP Address 192.168.254.254 or 198.102.102.254 (this depends on your firmware version).

- 5 If your PSII does not have an IP address, complete these steps:
  - Find your PSII and right-click it.
  - In the small dialog that opens, enter an IP Address, click OK.
  - The *Print Server Configuration* dialog opens.
  - Set the Subnet Mask (required). Set the Default Gateway (optional).

- Click OK.

The *Print Server Configuration* dialog opens:

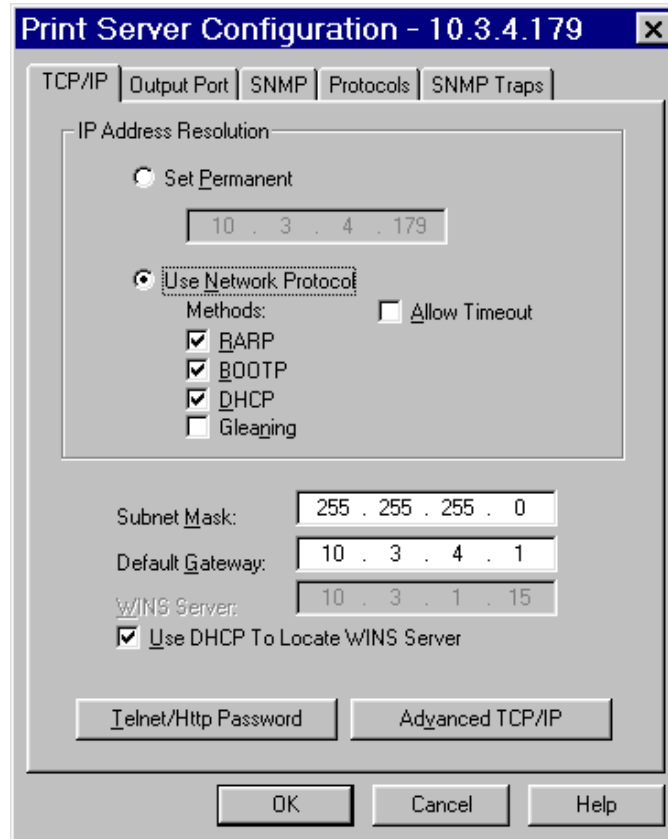

- 6 Type a new IP address in the text-box illustrated above.
- 7 Enable the **Set Permanent** radio button.

### To set the subnet, complete these steps:

- 8 From the ZebraNet View menu bar, select PrintServer>Configuration.
- 9 Click the *TCP/IP* tab.
- 10 From the *Print Server Configuration*>*TCP/IP* tab, in the *Subnet Mask* text-box, type in your subnet mask.
- 11 Confirm it is accurate, and click OK.

### To set the default gateway, complete these steps:

*These steps are Optional.*

- 1 From the ZebraNet View menu bar, select PrintServer>Configuration.

- 2 Click the *TCP/IP* tab.
- 3 From the *Print Server Configuration > TCP/IP* tab, in the *Default GateWay* text-box, type in your default gateway.
- 4 Confirm it is accurate, and click OK.

## In a non-Windows environment

These steps can be used with all printers. However, the liquid crystal display (LCD) instructions are for *XIII* units *only*.

**To assign an IP address from the printer LCD, complete these steps:**



**Important** • Your PSII must have firmware 6.3 and higher and your Zebra printer must have firmware x.10 or higher with an LCD.

- 1 Turn on the printer and allow 2 minutes for all systems to complete the self test. If you do not have a network cable in the port, the PSII prints the configuration label when it is ready.
- 2 On the printer front panel, press **SETUP/EXIT**.
- 3 On the printer front panel, press **PREVIOUS** twice until you reach the network settings menu item.
- 4 You can edit any of the following network settings in order to communicate with any PSII in your network environment.



**Important** • To change any of these settings, you need to use the default password: 1234.

- `default gateway` (default setting of 000.000.000.000)
- `subnet mask` (default setting 255.0.0.0)
- `ip address` (if initial default setting is 0.0.0.0, after 2 minutes this defaults to 198.102.102.254 or 192.168.254.254—depends on firmware version)
- `ip protocol` (gleaning only, rarp bootp, dhcp, dhcp and bootp, all)
- `ip resolution` (dynamic, permanent) The printer menu item **IP RESOLUTION** must be set to **PERMANENT** if attempting to assign the IP address from the front panel.

## Assigning an IP address via a Telnet session

If your environment is not Windows-based, this section is for you. However, this method can be used in a Windows environment, too.

The methods used for assigning an IP address with a Telnet session are **Static Route** and **Gleaning**.



**Important** • This applies to any TCP/IP capable workstation/ host networked with the Zebra printer. Both the workstation/host and the PSII must be on the same network segment.

Before you can Telnet to the PSII and configure it, you must first assign the PSII a temporary IP address.

### Static Route: To use this method, complete these steps:

- 1 Turn on the printer and wait for 2 minutes to allow for the device self test.

During this time, the PSII performs an address broadcast. If no address is assigned to the unit (via DHCP or Bootp), it uses a default address. The default address used varies with the version of firmware the PSII is using. Print the PSII configuration label to confirm the address; for details see [page 28](#).

- 2 You can use the `route add` command to place the default IP address into the workstation's network routing table.



**Example** • In the next step, \*\*\*\* is the IP address on the PSII configuration label.

- 3 At the workstation/host command prompt (in Windows, go the DOS prompt), type:

```
route add **** "IP address of the workstation" 0
```



**Note** • The zero (0) placed at the end of the "route add" command is optional on some systems.

- 4 Telnet to the PSII by typing:

```
"Telnet xxx.xxx.xxx.xxx"
```

The password is 1234.

- 5 When finished, you can alter the appropriate settings. When complete, do a reset and allow the PSII self test to complete before proceeding with any communications activity.

### Gleaning: To use this method, complete these steps:

A method by which the PSII uses the IP address of the first ping packet that is sent to its Hardware address.

- 1 Add an entry to the ARP table that assigns an IP address to an Ethernet (Hardware) address.

The syntax for this command is: `arp -s "temporary ipaddress of print server" "MAC Address (print server hardware address)"` `arp -s <temporary ip address> <MAC Address>`

➔ **Example** • You would type: `arp -s 10.3.50.59 00-40-68-1D-B9-86`

- 2 Power cycle the printer.
- 3 As the printer reboots, begin a continuous ping to the address assigned previously.



**Note** • Most UNIX systems use a continuous ping.

To use a continuous ping from a Windows host, you must issue the command: `ping -t "ipaddress"`.

- 4 When the PSII begins to respond, stop the ping activity.  
In Windows, **Ctrl + C** halts the pinging.
- 5 Telnet to the PSII and assign the appropriate IP address, subnet mask, and gateway if applicable.
- 6 Once this is complete, reset the PSII.

For details on resetting the PSII, see [Reset on page 86](#).

## Setting Alerts

It is important to understand the relationship between the PSII and the printer when you are establishing alerts. Here are the relationships you need to be aware of:

- Non-ZebraLink-enabled printers—can send alerts on only a specific set of printer errors that are reported in the IEEE 1284 protocol.
- ZebraLink-enabled printers—ZebraLink allows for the printer to send alerts *not* in the IEEE 1284 protocol.

## ZebraNet View

In this section are step-by-steps instructions on how to set up an alert using ZebraNet View. For information on setting up alerts using ZebraLink, see [ZebraLink on page 38](#).

### To set alerts (traps) using ZebraNet View, complete these steps:

- 1 In the ZebraNet View dialog, from the menu bar select Print Server>Configuration.
- 2 Click the *SNMP Traps* tab.



The Printer Traps check boxes are the alerts you can set from ZebraNet View.

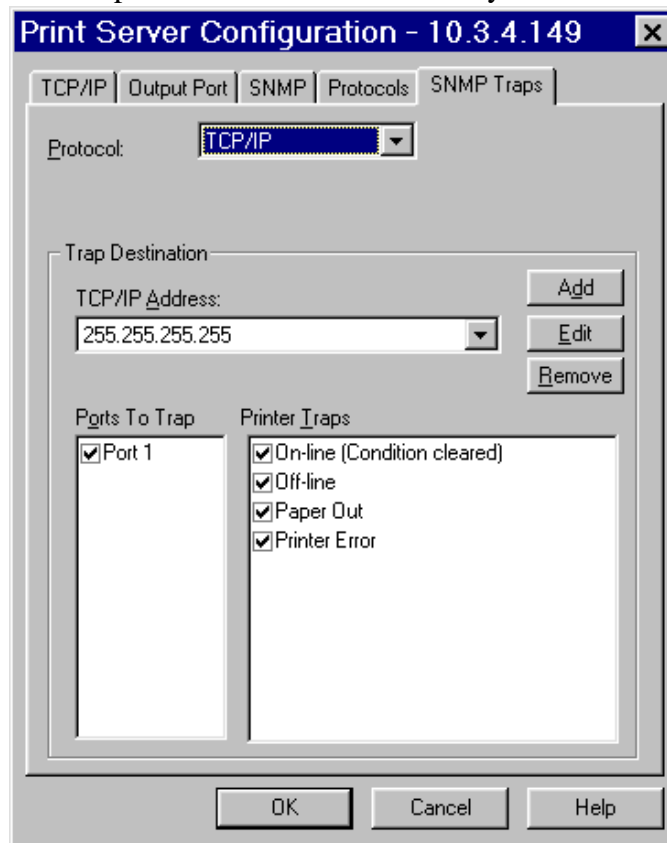

- 3 Enable the alerts (printer traps) you want to set here and click OK.
- 4 To monitor the alerts you established, from the task bar select Start>ZebraNet Utilities>ZebraNet Alert.

The ZebraNet Alert dialog opens:

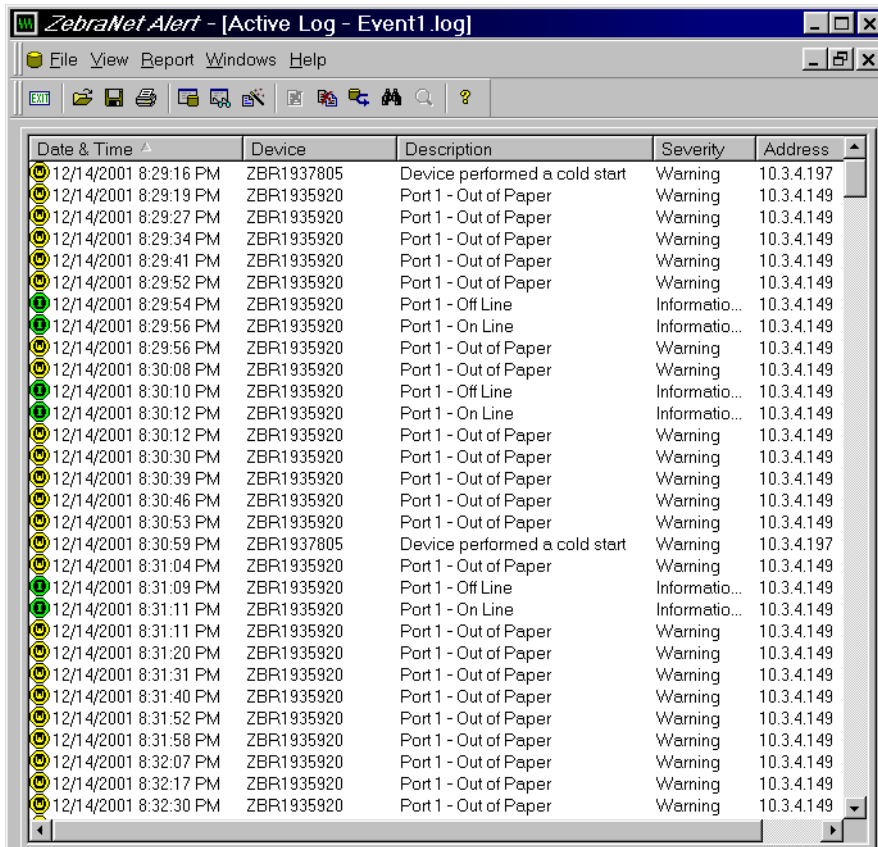

The screenshot shows a window titled "ZebraNet Alert - [Active Log - Event1 .log]". The window contains a table with the following columns: Date & Time, Device, Description, Severity, and Address. The table lists various events such as "Device performed a cold start", "Port 1 - Out of Paper", and "Port 1 - On Line" with their respective timestamps, device IDs, and IP addresses.

Date & Time	Device	Description	Severity	Address
12/14/2001 8:29:16 PM	ZBR1937805	Device performed a cold start	Warning	10.3.4.197
12/14/2001 8:29:19 PM	ZBR1935920	Port 1 - Out of Paper	Warning	10.3.4.149
12/14/2001 8:29:27 PM	ZBR1935920	Port 1 - Out of Paper	Warning	10.3.4.149
12/14/2001 8:29:34 PM	ZBR1935920	Port 1 - Out of Paper	Warning	10.3.4.149
12/14/2001 8:29:41 PM	ZBR1935920	Port 1 - Out of Paper	Warning	10.3.4.149
12/14/2001 8:29:52 PM	ZBR1935920	Port 1 - Out of Paper	Warning	10.3.4.149
12/14/2001 8:29:54 PM	ZBR1935920	Port 1 - Off Line	Information...	10.3.4.149
12/14/2001 8:29:56 PM	ZBR1935920	Port 1 - On Line	Information...	10.3.4.149
12/14/2001 8:29:56 PM	ZBR1935920	Port 1 - Out of Paper	Warning	10.3.4.149
12/14/2001 8:30:08 PM	ZBR1935920	Port 1 - Out of Paper	Warning	10.3.4.149
12/14/2001 8:30:10 PM	ZBR1935920	Port 1 - Off Line	Information...	10.3.4.149
12/14/2001 8:30:12 PM	ZBR1935920	Port 1 - On Line	Information...	10.3.4.149
12/14/2001 8:30:12 PM	ZBR1935920	Port 1 - Out of Paper	Warning	10.3.4.149
12/14/2001 8:30:30 PM	ZBR1935920	Port 1 - Out of Paper	Warning	10.3.4.149
12/14/2001 8:30:39 PM	ZBR1935920	Port 1 - Out of Paper	Warning	10.3.4.149
12/14/2001 8:30:46 PM	ZBR1935920	Port 1 - Out of Paper	Warning	10.3.4.149
12/14/2001 8:30:53 PM	ZBR1935920	Port 1 - Out of Paper	Warning	10.3.4.149
12/14/2001 8:30:59 PM	ZBR1937805	Device performed a cold start	Warning	10.3.4.197
12/14/2001 8:31:04 PM	ZBR1935920	Port 1 - Out of Paper	Warning	10.3.4.149
12/14/2001 8:31:09 PM	ZBR1935920	Port 1 - Off Line	Information...	10.3.4.149
12/14/2001 8:31:11 PM	ZBR1935920	Port 1 - On Line	Information...	10.3.4.149
12/14/2001 8:31:11 PM	ZBR1935920	Port 1 - Out of Paper	Warning	10.3.4.149
12/14/2001 8:31:20 PM	ZBR1935920	Port 1 - Out of Paper	Warning	10.3.4.149
12/14/2001 8:31:31 PM	ZBR1935920	Port 1 - Out of Paper	Warning	10.3.4.149
12/14/2001 8:31:40 PM	ZBR1935920	Port 1 - Out of Paper	Warning	10.3.4.149
12/14/2001 8:31:52 PM	ZBR1935920	Port 1 - Out of Paper	Warning	10.3.4.149
12/14/2001 8:31:58 PM	ZBR1935920	Port 1 - Out of Paper	Warning	10.3.4.149
12/14/2001 8:32:07 PM	ZBR1935920	Port 1 - Out of Paper	Warning	10.3.4.149
12/14/2001 8:32:17 PM	ZBR1935920	Port 1 - Out of Paper	Warning	10.3.4.149
12/14/2001 8:32:30 PM	ZBR1935920	Port 1 - Out of Paper	Warning	10.3.4.149

In this dialog you can view the log of errors and monitor the activity of your printer(s).

## ZebraLink

In this section are step-by-step instructions on how to set up an alert using ZebraLink. For information on setting up alerts using ZebraNet View, see [ZebraNet View on page 44](#).



**Important** • If you do not have a ZebraLink-enabled printer, these steps will not work.

**To view Alert Setup using ZebraLink, complete these steps:**

- 1 From the *Printer Home Page*, click [Alert Setup](#).

The *Alert Messaging System* dialog opens:

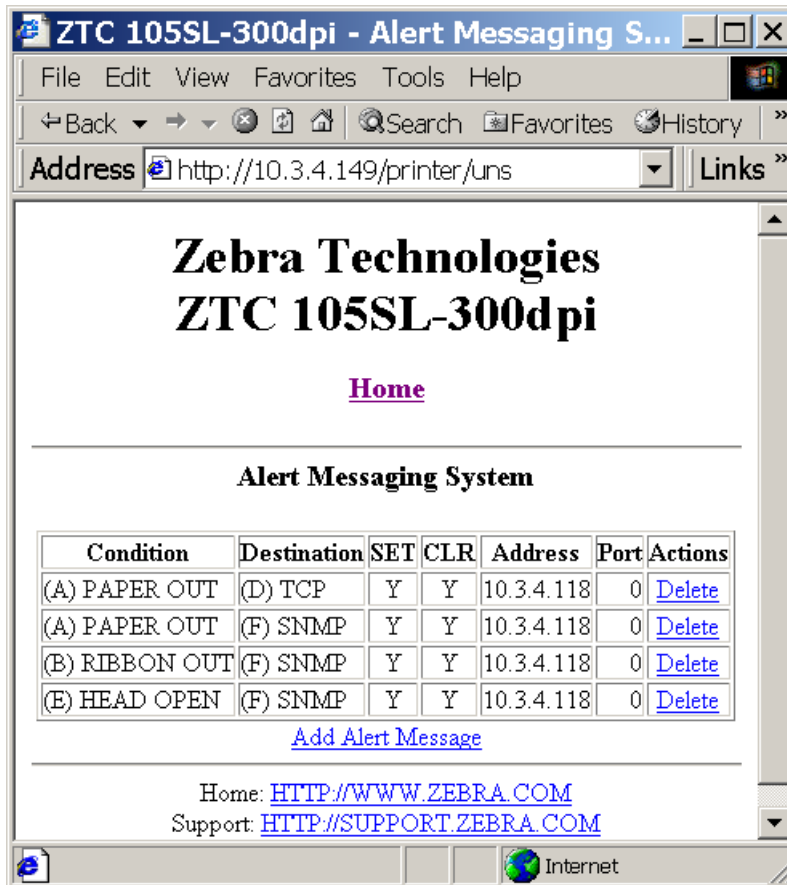

To add an alert, you need the default user ID and password.

- 2 To add an alert, click [Add Alert Message](#).
- 3 Select accordingly.
- 4 You can use ZebraNet Alert to monitor alerts set through a ZebraLink-enabled printer.

From this Web page you can add alert messages to notify you when a printer is out of paper, needs a ribbon, and so on.

## Establishing Email Alert Messaging

ZebraNet Alert supports email notification of printer errors sent directly to any valid email address. You can have multiple email addresses set up for routing different error messages, or split notifications between email and other network management tools.

**To begin receiving email notification of errors, complete these steps:**

- 1 From the browser view, in the *Address* text-box type in the printer's IP address.

The *Printer Home Page* opens.

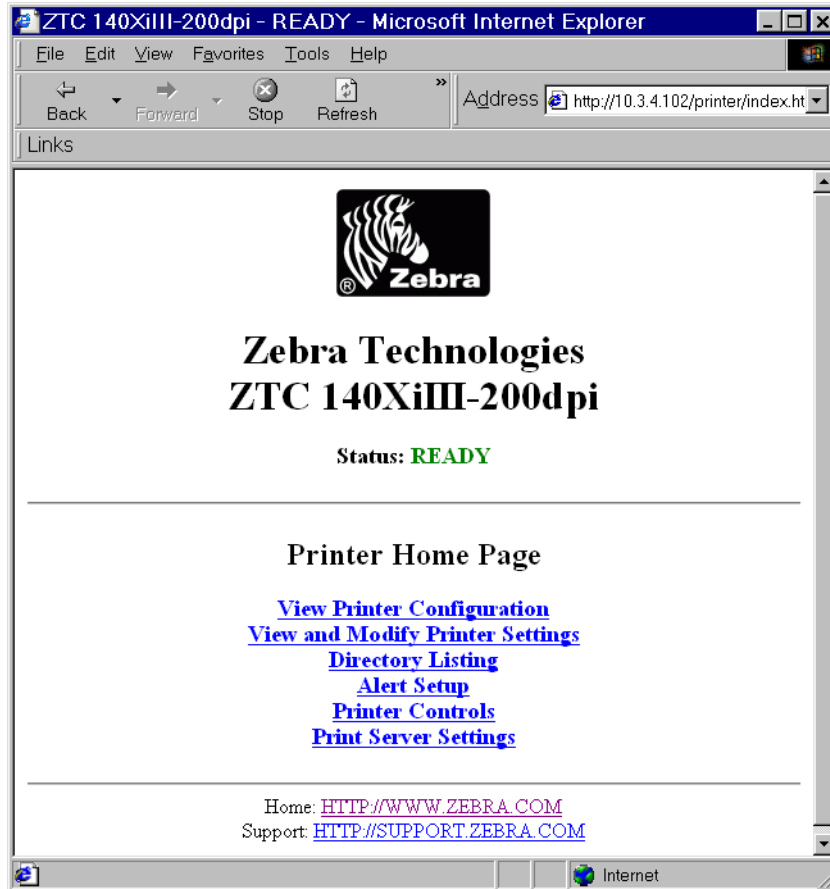

- 2 From the *Printer Home Page*, click [Alert Setup](#).

The Alert Setup page shows a list of message notifications and their respective destinations (if no notifications are listed).

- 3 To set up email notification, go to the *Alert Setup* page and click [Add Alert Message](#).

The *Add Alert Message* page opens:

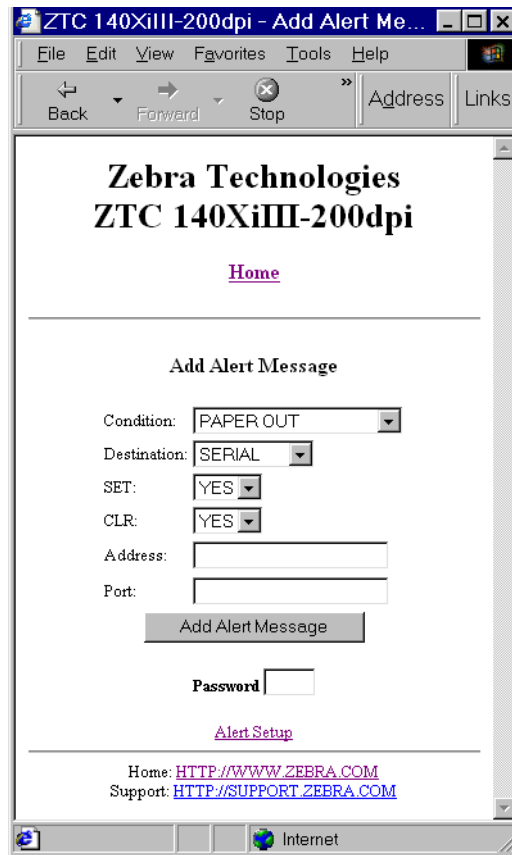

**Important** • The printer accepts only the last configuration made.

- 4 Specify the condition to send over email, such as HEAD ELEMENT BAD or PAPER OUT.
- 5 Enter a valid email address for the messages to be sent to.



**Example** • `admin@yourcompany.net` (The Port field can be ignored for email setup.)



**Warning** • A password is required. If you forget to enter the password, the alerts you just set are deleted.

- 6 Click Add Alert Message.

## Getting Started

### Setting Alerts

- 7 You can continue to add more settings or, if finished, save the current settings.
- 8 From the Printer Home Page, select PrintServer Settings>Network Communications Setup.
- 9 Click [SMTP Email Alerts](#).



**Note** • The *SMTP Server* address might be referred to as *Mail Server* address.

- 10 Specify your SMTP server address.

When these steps are done, you can begin receiving email notification messages.

### To monitor alerts, complete these steps:

- 1 From the task bar, select Start>Programs>ZebraNet Utilities>ZebraNet Alert.

The *Active Log* dialog opens, displaying a list of all the logged alerts:

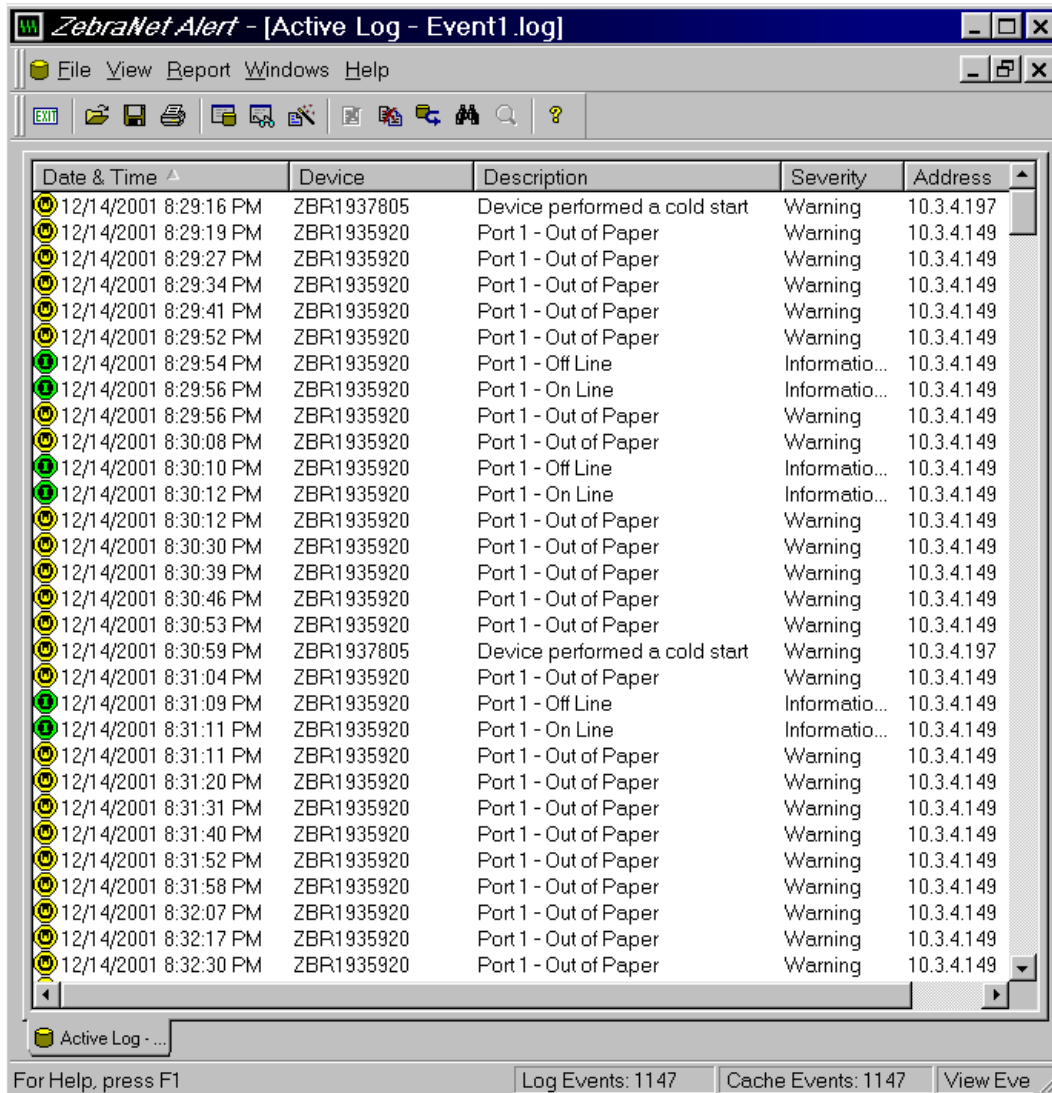

- 2 From this dialog, you can track the printer(s) activity and status.
- 3 From the menu bar, you can explore all the other features, such as Reports.

# Checking PSII Configuration Settings

This section provides steps on how to check PSII's configuration settings using ZebraNet View and a browser.

## ZebraNet View

To check configuration settings, complete these steps:

- 1 From the task bar, select Start>Programs>ZebraNet Utilities>ZebraNet View.

The *ZebraNet View* dialog opens:

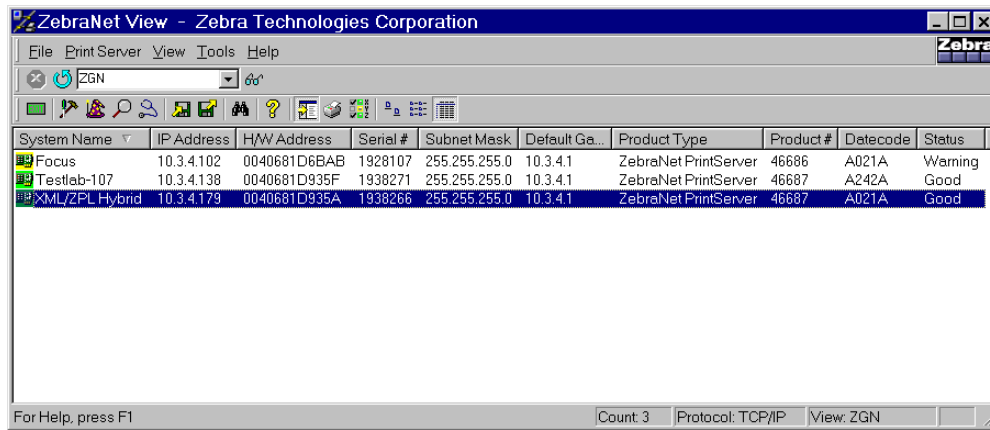

- 2 From the menu bar, select Print Server>Configuration.



The *Print Server Configuration* dialog opens:

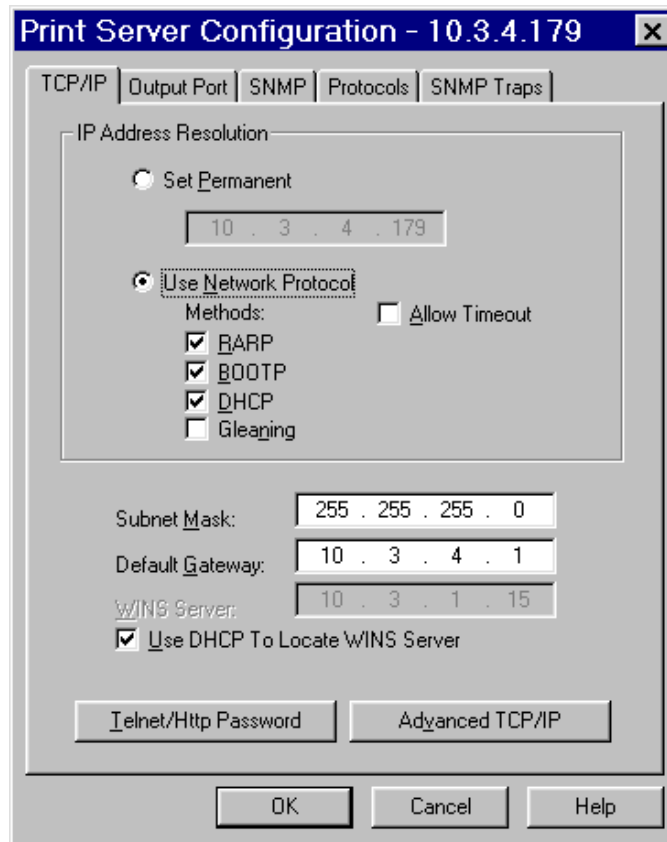

- 3 This dialog offers multiple tabs to choose from. Each tab contains various configuration settings that you can change.

For details on the configurations, see [page 108](#).

## Browser

This section provides steps on how to check PSII's configuration settings using its Web pages.

### To access the PSII settings, complete these steps:

- 1 Open a Web browser.
- 2 In the *Address* text-box, type your printer's IP address, then press Enter.

## Getting Started

### Checking PSII Configuration Settings

Your browser page looks similar to this:

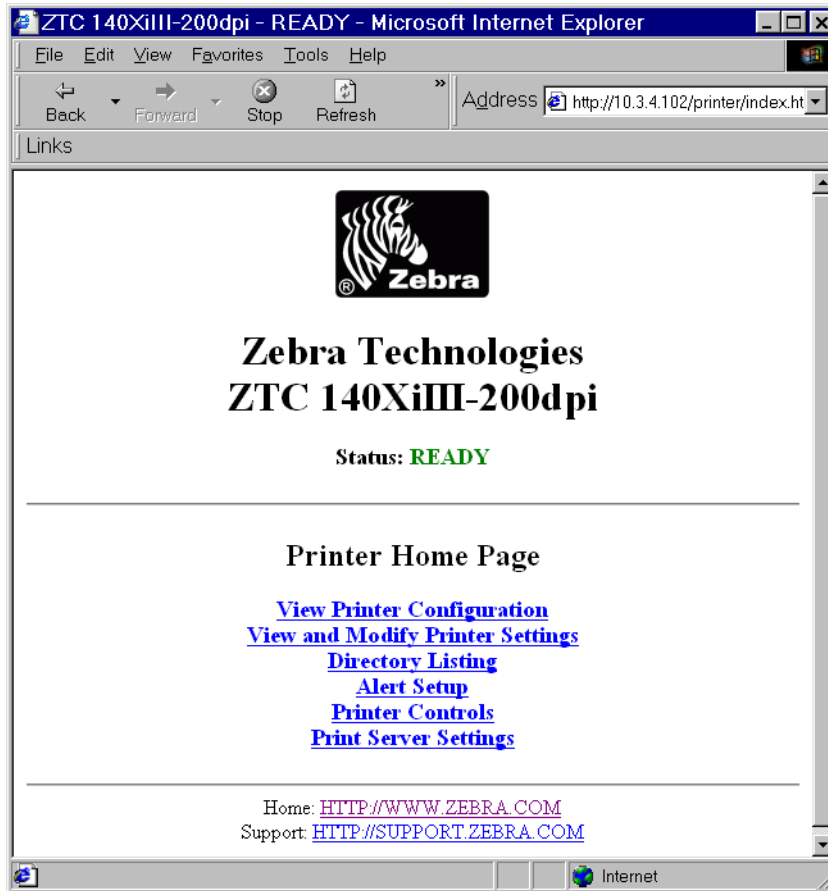

- 3 From the *Printer Home Page*, click [Print Server Settings](#).

The default User ID and password are required.



**Important** • The illustration of the [Printer Server Settings](#) page is based on a ZPL printer. If you have an EPL printer, the menu options on the Print Server page are slightly different.

The *Print Server Configuration Page* opens:

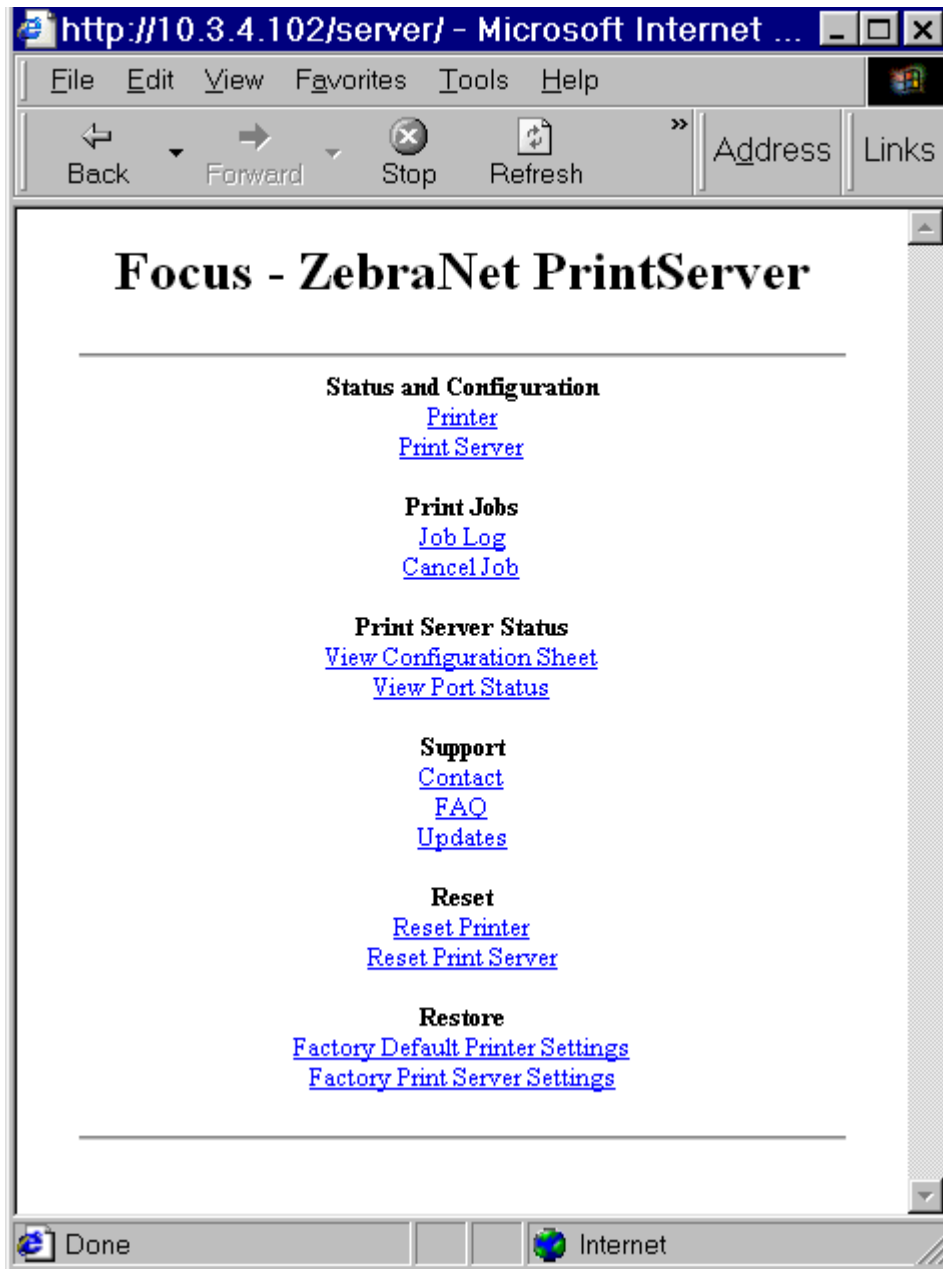

**To access the PSII settings, complete these steps:**

- 1 From the *Print Server* page, click [Print Server](#).

## Getting Started

### Checking PSII Configuration Settings

The *Print Server Configuration* page opens:

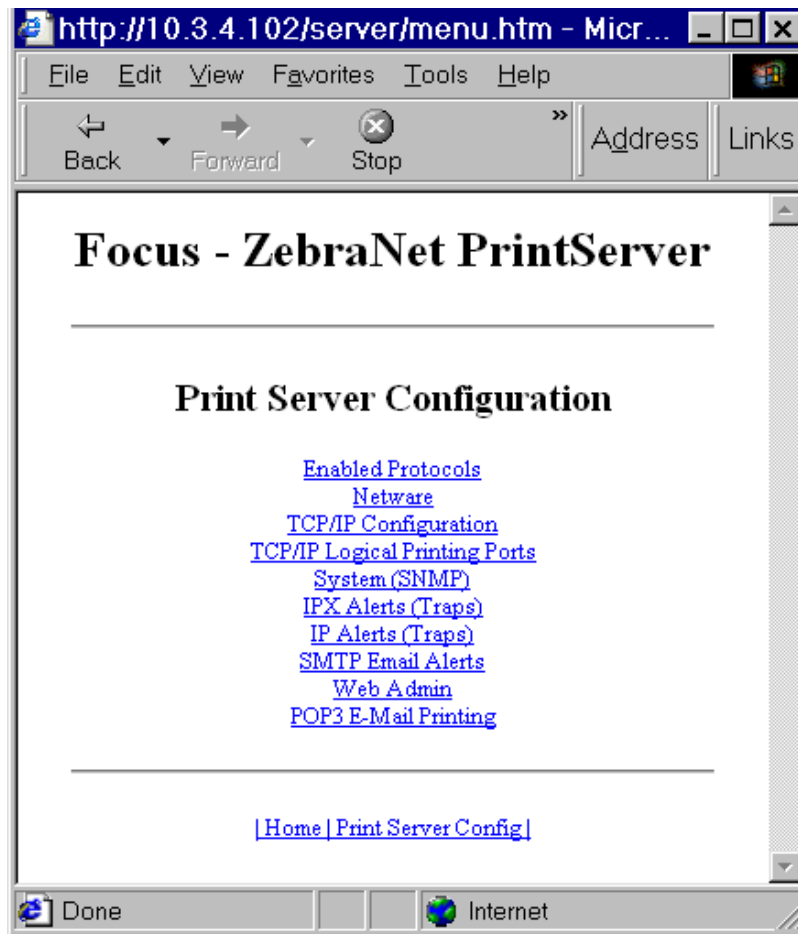

- 2 For details on the configuration choices, see *To check configuration settings, complete these steps: on page 44.*

## Setting up a ZebraNet Connect IP

ZebraNet Connect IP allows you to send jobs to PrintServers that use Dynamic IP addresses (DHCP). It also notifies you of printer errors, such as *paper out* or *head open*. When print jobs are printed through ZebraNet Connect IP, they are sent directly to PSII and are not routed through a network server, resulting in a reduction of network traffic.



**Note** • The DHCP feature of ZebraNet Connect IP can rediscover a PSII on the local subnet, even when its IP address might be changing (e.g., when using DHCP for IP address resolution). The PSII is relocated by its port name as configured through ZebraNet View (the default name is Serial Number-Port Number). This feature is enabled on the local subnet only. A non-local PSII device is not rediscovered if the IP address changes.

If you have printing problems while using the ZebraNet Connect IP printing port, you may check the status of the port or change its settings through the printer Properties dialog.

- For Windows 95/98, select Port Settings under the Details tab.
- For Windows NT 4.0 or Windows 2000, select Configure Port under the Ports tab.

### Windows NT 4.0/Windows 2000

If you are using the Windows NT 4.0 or Windows 2000 operating system, use the following procedure to set up a printer port for the PSII.

- 1 From the task bar, select **Start>Settings>Printers**.
- 2 Select the Windows printer to use when printing with the PSII.
- 3 From the menu bar, select **File>Properties**.
- 4 To add a ZebraNet Connect IP port, in the Ports tab select **Add Port**.
- 5 From the list of Available Printer Ports, select *ZebraNet Connect Monitor* as the type of port to add, and click **New Port**.



**Note** • If ZebraNet Connect IP monitor is not listed, verify that the ZebraNet Connect IP software has been properly installed. To do this, you need to reinstall the software and choose **Modify**.

## Getting Started

### Setting up a ZebraNet Connect IP

You enter into the Add ZebraNet Connect Port screen, where there is a list of all PSII devices available on the local subnet.

- The TCP/IP monitor searches only the local subnet.
  - The IPX/SPX monitor retrieves all devices found in the NetWare bindery.
- 6** If the port you want to add is listed in the Ports Available on Local Subnet window, select the port name. If the port you want to use is not listed, you can:
- Select **Cancel** and repeat step 5 to rediscover the print servers.
  - In ZebraNet Connect for IPX/SPX, click **Search** and enter the PrintServer's Network Number and Hardware Address.

In ZebraNet Connect, click the Locate Non-local Device button and enter the static TCP/IP Address used for the PSII.



**Note** • The ZebraNet Connect for TCP/IP DHCP discovery feature relocates a PSII device on the local subnet by its port name, even if the IP address changes. This feature is enabled on the local subnet only. A non-local PSII device is not rediscovered if the IP address changes.

- 7** Click **Add**.
- 8** To close the *Printer Ports* dialog, click **Cancel**.
- 9** To save the configuration, click **OK**.

Now you can use ZebraNet Connect. Whenever you print to the Windows printer configured with ZebraNet Connect, your print job will go directly to the ZebraNet PSII port.

## Windows 95/98/Me

**To set up a PSII port using Windows 95/Windows 98/Me, complete these steps:**

- 1** From the task bar, select **Start>Settings>Printers**.
- 2** Select the Windows printer that you want to print with ZebraNet Connect IP.



**Note** • Under Windows 95, you have to set up the printer for a local port first, then open Properties from the File menu and continue with the configurations.

- 3** From the file menu, select **File>Properties**.

- 4 To add a ZebraNet Connect IP port, in the *Details* tab select Add Port.
- 5 From the *Add Port* dialog, select **Other**, then select the ZebraNet Connect Monitor as the type of port to add.
- 6 Click OK.



**Note** • If ZebraNet Connect IP is not listed, verify that the software has been properly installed.

The Add ZebraNet Connect Port screen opens. There is a list of all PSII devices discovered on the network.

- The TCP/IP monitor searches only the local subnet.
  - The IPX/SPX monitor retrieves all devices found in the NetWare bindery.
- 7 If the port you want to add is listed in the Ports Available on Local Subnet window, select the port name. If the port you want to use is not listed, you can:
    - Select Cancel and repeat step 5 to rediscover the PSII devices.
    - In ZebraNet Connect IP for IPX/SPX, click **Search** and enter the PSII's network number and hardware address.
    - In ZebraNet Connect IP, click the Locate Non-local Device button and enter the static TCP/IP address used for the PSII.
  - 8 Click Add.
  - 9 To save the configuration, click OK.

Now you can use ZebraNet Connect IP. Whenever you print to the Windows printer configured with ZebraNet Connect IP, your print job will go directly to the PSII port.

## IPX (NetWare)

ZebraNet Connect for IPX/SPX is a utility that allows simple, direct, IPX/SPX printing from your computer to a printer attached to a ZebraNet PSII. Print jobs printed through the ZebraNet Connect utility are sent directly to the PSII and do not require a NetWare server, resulting in a reduction of network traffic.

If you have printing problems while using the PSII Connect printing port, you can check the status of the port or change its settings under the printer Properties window.

- For Windows 95/98, select Port Settings under the Details tab.
- For Windows NT 4.0 or Windows 2000, select Configure Port under the Ports tab.

 **Getting Started****Setting up a ZebraNet Connect IP**

**Notify on Printer Error**—This feature checks the printer status prior to printing the job. If a printer error is detected (e.g., printer off-line), the error description is given.

**Notify When Printed**—This feature provides an alert when your job is active on the printer. This is useful if the printer is unusually busy.

**Description**—An optional field in which you can list any useful information about the printer port, such as location.



# Enabling Protocols

You can enable protocols with WebView or ZebraNet View. This section provides you with directions for accessing and enabling protocols using both WebView and ZebraNet View.

## WebView

This section contains directions for accessing protocols using WebView. The browser illustrations were captured from a ZebraLink-enabled printer.

### To enable protocols using WebView, complete these steps:

- 1 Open a Web browser.
- 2 In the *Address* text-box, type your printer's IP address, then press Enter.

Your browser page looks similar to this:

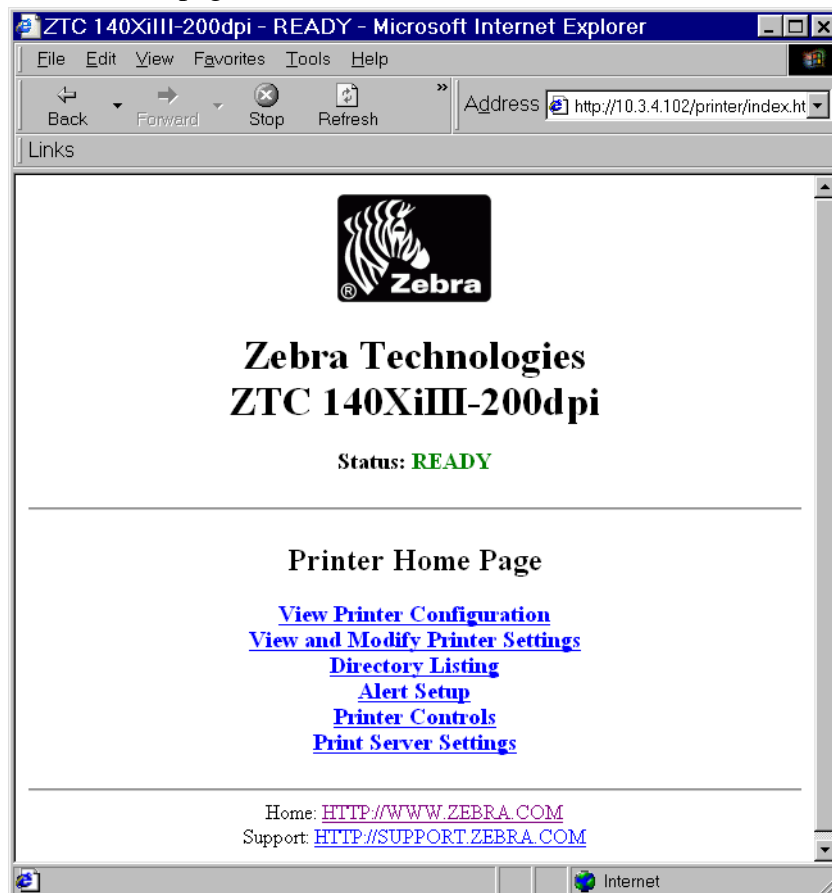

- 3 From the *Printer Home Page*, click [Print Server Settings](#).

The default User ID and password are required.

- 4 From the *Print Server* page, click [Print Server](#).

The *Print Server Configuration* page opens:

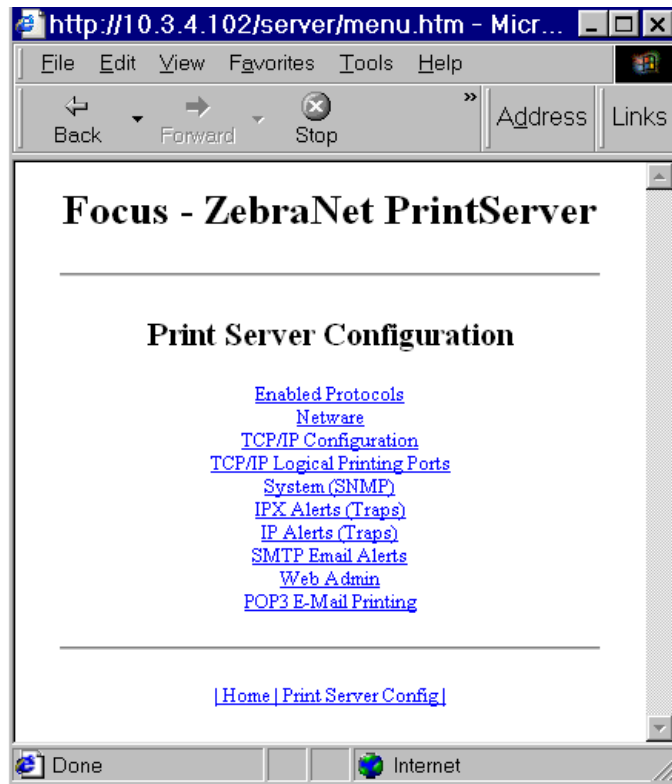

- 5 From the *Print Server Configuration* page, click [Enabled Protocols](#).

The *Protocol Configuration* page opens:

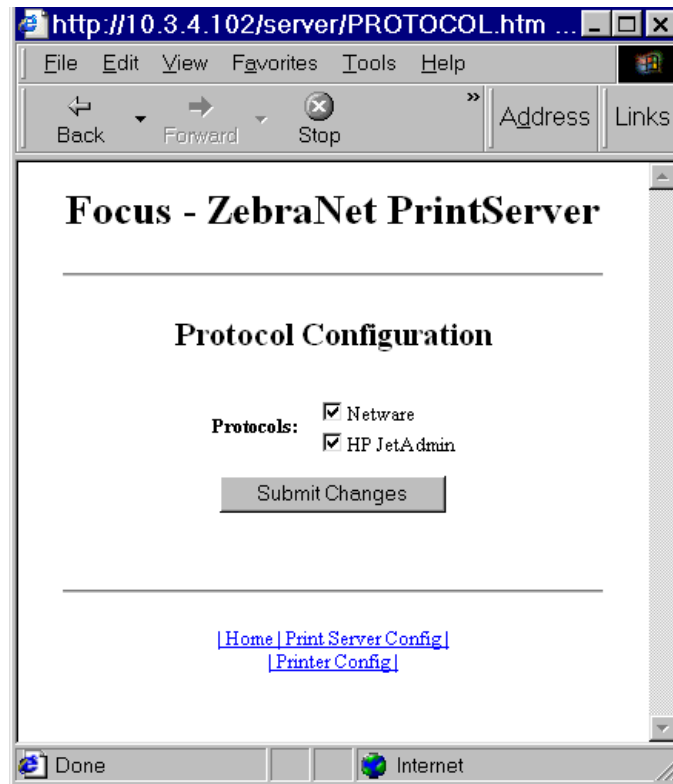

- 6 Select the protocols you want to enable, then click **Submit Changes**.  
You get a confirmation to reset the unit for changes to take place.

## ZebraNet View

This section contains directions for accessing protocols using ZebraNet View.

**To enable protocols using WebView, complete these steps:**

- 1 From the task bar, select **Start>Programs>ZebraNet Utilities>ZebraNet View**.

The *ZebraNet View* dialog opens:

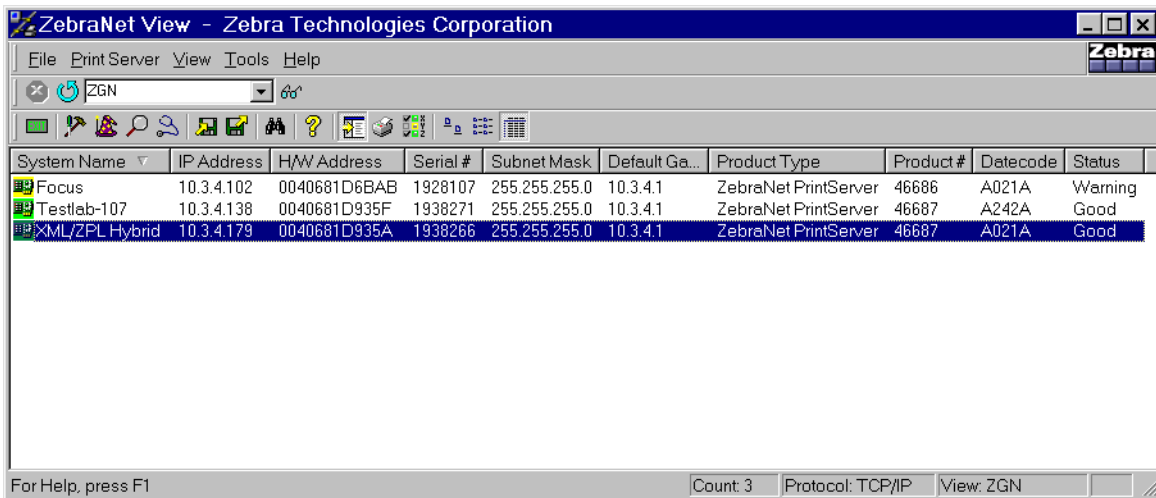

- 2 From the menu bar, select **Print Server>Configuration**.
- 3 Click the *Protocols* tab.

The *Protocols* tab opens:

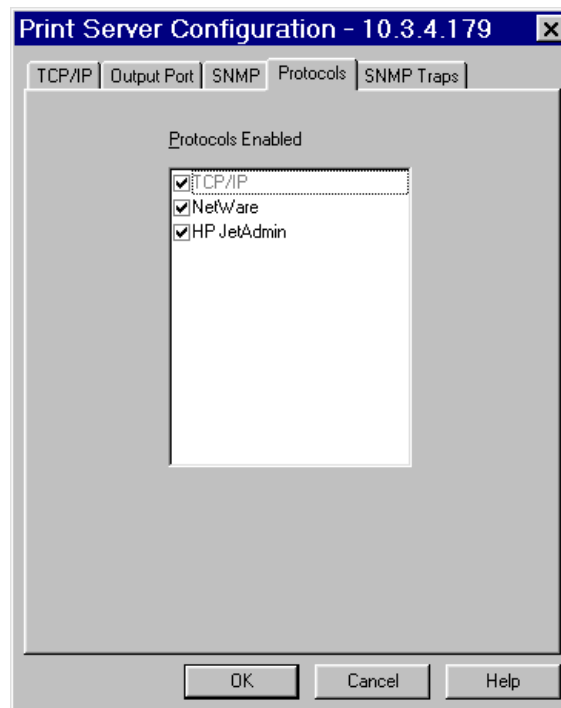

- 4 Select the protocols you want to enable, then click **OK**.  
A confirmation message opens.
- 5 To accept changes, click **OK**.

# Defaulting the PSII

This section provides you with instructions for defaulting the PSII to factory settings using WebView, ZebraNet View, and the Test button.

## WebView

To default the PSII to factory settings using WebView, complete these steps:

- 1 From the ZebraNet PrintServer view, click [Factory Print Server Settings](#).

The *Restore to Factory Defaults* page opens:

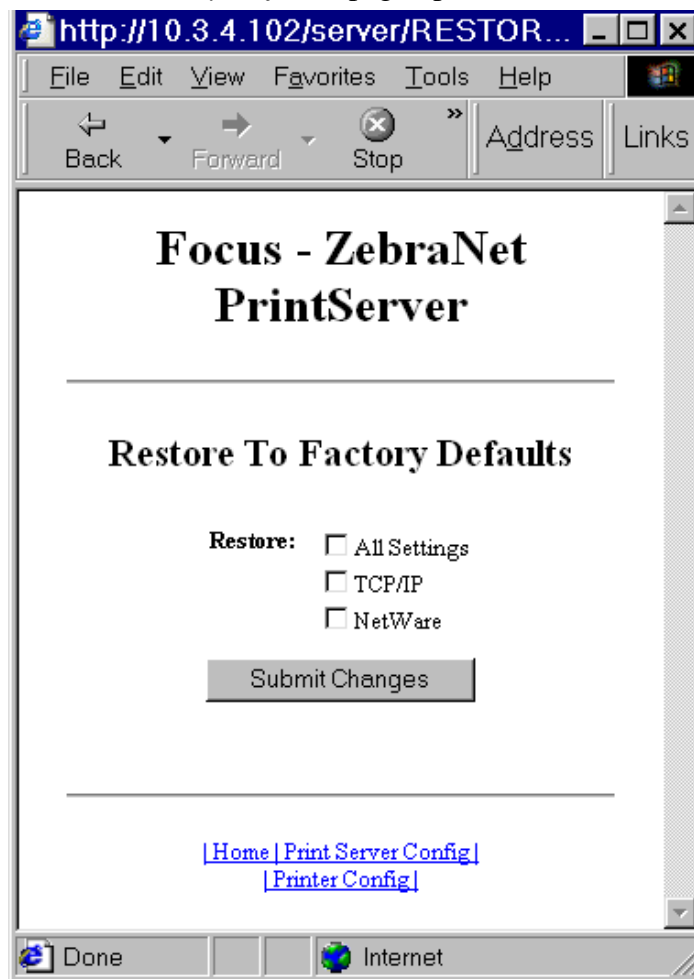

## Getting Started

### Defaulting the PSII

- 2 Enable the check box of the settings you want to reset, and click Submit Changes.



**Important** • With the reset command on its way to the PSII, the HTTP connection is unavailable while the PSII re-initializes. You need to wait a few seconds before trying to reestablish a connection.

## ZebraNet View

**To default PSII to factory settings using ZebraNet View, complete these steps:**

- 1 From the task bar, select Start>Programs>ZebraNet Utilities>ZebraNet View.

The *ZebraNet View* dialog opens:

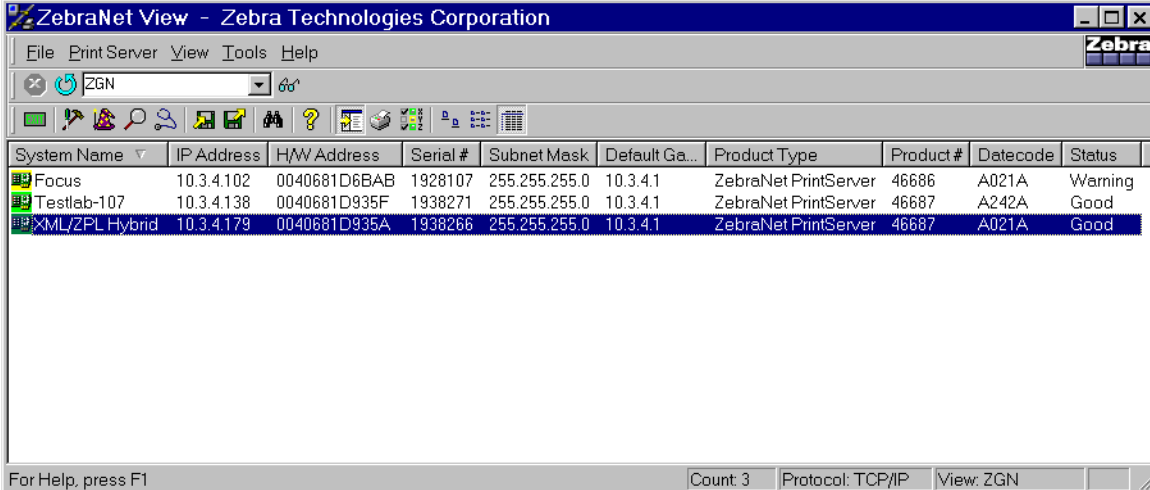

The screenshot shows the ZebraNet View application window with a menu bar (File, Print Server, View, Tools, Help) and a toolbar. Below the toolbar is a table with the following data:

System Name	IP Address	H/W Address	Serial #	Subnet Mask	Default Ga...	Product Type	Product #	Datecode	Status
Focus	10.3.4.102	0040681D6BAB	1928107	255.255.255.0	10.3.4.1	ZebraNet PrintServer	46686	A021A	Warning
Testlab-107	10.3.4.138	0040681D935F	1938271	255.255.255.0	10.3.4.1	ZebraNet PrintServer	46687	A242A	Good
XML/ZPL Hybrid	10.3.4.179	0040681D935A	1938266	255.255.255.0	10.3.4.1	ZebraNet PrintServer	46687	A021A	Good

At the bottom of the window, there is a status bar with the text "For Help, press F1", "Count: 3", "Protocol: TCP/IP", and "View: ZGN".

- 2 From the menu bar, select Print Server>Reset.

The *Reset Print Server* dialog opens:

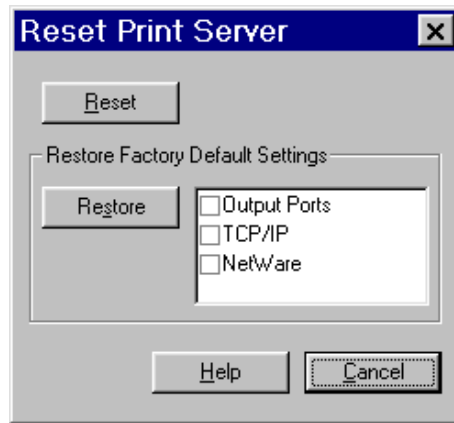

- 3 Select the settings you want to reset, then click **Restore**.

## Test Button

**To default the PSII to factory settings using the Test button, complete these steps:**

- 1 The printer is turned off.  
The **Test** button is a small hole on the PSII device. To press the **Test** button, you need to insert something small into the hole, like a paperclip.
- 2 With the printer turned off, press and hold the **Test** button on the PSII device and turn on the printer.
- 3 The status indicator tells you when PSII has been reset to factory defaults, as follows:
  - If an active network cable is connected to the PSII, the status indicator turns solid **green**. When this happens, you can release the **Test** button.
  - If there is **not** an active network cable connected to the PSII, the status indicator flashes **green**. When this happens, you can release the **Test** button.
  - For more details on status indicators, see [Status Indicator on page 124](#).



**Getting Started**  
Defaulting the PSII



## CHAPTER 4

# NetWare Print Configuration

This chapter provides you with instructions for configuring Novell's NetWare for printing to PSII.

### Contents

Printing in PServer Mode .....	62
--------------------------------	----

## Printing in PServer Mode

You *must* have Zebra's snap-in for Novell installed to complete these steps.

**To configure in Novell's NetWare for printing to the PSII, complete these steps:**



**Important** • You must have PSII installed before you proceed with these steps.

- 1 From the task bar, select Start>Programs>ZebraNet Utilities>ZebraNet View.
- 2 Create a ZebraNet object by completing the following steps:
  - From Novell's NetWare Administrator, select the container in which you want the object created.



**Example** • To create an object that is subordinate to sales, choose SALES.

- From the menu bar, select Object>Create.  
If the Create option is gray, you do not have sufficient rights, or you selected a leaf object.
- Find *Zebra Print Server*, select it, and click **OK**.  
If the class of the object you want to create is not listed, you cannot create it in the container you selected.
- Define filter and sort devices for displaying a list of PSII devices to choose from, and click **OK**.
- Type in a name for the new PSII object, and click **Create**.  
Wait for the print server to reset.
- (*optional*) To rename one of the PSII devices, select the one you want to rename, and click **Create**.

- 3 In the *Directory Tree*, find your object, and double-click.
- 4 Select Assignments>Assign>New.
- 5 Next to the *Context* text-box, click the *Directory Tree* icon, then double-click the browse arrow.
- 6 Find the *Contexts* container you want, and double-click.  
It auto-fills into the *Context* text-box.

- 7 Enter the printer name you want, and click **Create**.
- 8 Next to the *Print Queues* section, click **New**.
- 9 Next to the *Context* text-box, click the *Directory Tree*, and double-click the Browse arrow.
- 10 Select the Context you want.  
It auto-fills the text-box.
- 11 In the *Print Queue Name* text-box, type in the name you want.
- 12 Next to the *Print Queue Volume* text-box, click the *Directory Tree* icon.
- 13 Double-click the *Volume* you want, and click **Create**.  
Your *Print Queue Name* is listed with the name of your *Context* as the extension.
- 14 Click **OK**, and then click **OK** again.  
Wait for the print server to reset.
- 15 To refresh your Directory Tree, double-click on your context twice.  
You now see the Object, Printer Name, and Print Queue that you created.

**To attach a generic text driver to print to the PSII configured in NetWare, complete these steps:**

1. On Add Printer double-click, and click **Next**.
- 2 Select Network Printer, and click **Next**.
- 3 Click **Browse** and click on the context.  
You can see the queue and printer that you created.
- 4 Select the queue, and click **OK**.  
The Network path (queue name) auto-fills.
- 5 Click **Next**.
- 6 Select Generic for Manufacturer of printer, and click **Next**.
- 7 Select *Keep Existing Driver*, and click **Next**.
- 8 Enter the printer name you want and click **Next**.
- 9 Select *No* for printing a Test Page, and click **Finish**.
- 10 From the *Printers* dialog, double-click on your new printer and set it as the default printer.
- 11 Open a text editor, create ZPL (Zebra Programming Language) file, and print.



## CHAPTER 5

# Printing Configurations

This chapter provides information and instructions on configuring your printer.

### Content

BSD (Berkeley Software Distribution)-Style Print Queue .....	66
System V Queue Installation.....	68

# BSD (Berkeley Software Distribution)-Style Print Queue

BSD is a version of the UNIX OS that distributes software that includes TCP/IP.

## Configuring the Print Queue

For remote BSD-style LPD printing, add the PSII as a remote printer in the `/etc/printcap` database to each host printing to the PSII. You can add printcap options as needed. If you are unfamiliar with these options, consult the printcap documentation.



**Important** • You must be logged in as `root`.

The entry looks similar to this:

```
local_print_queue_name|[printer_model_and_manufacturer]
:\
:lp=:mx#0:rm=ZebraNet_name:\
:rp=remote_print_queue_name:\
:sd=path_to_spool_directory:lf=just log_file_name
```

`local_print_queue_name`—This defines the name of the printcap entry. It is used by the LPR/LPD utilities to specify which printcap entry is being referenced. Additional printcap entries can be added as needed for different queue types. Each entry must have a unique `local_print_queue_name` and a different spool directory to work properly. When you are ready to print, use the `local_print_queue_name` that matches the data type of the file to be printed.

`ZebraNet_name`—This is the name (alias) of the ZebraNet PSII. This must be the same name as entered in the `/etc/hosts` file or your NIS or DNS system. An IP address may also be used here.

`remote_print_queue_name`—This entry determines the ZebraNet port where the print job will be printed and optionally specifies ASCII printing that must end for LF1.

`path_to_spool_directory`—This is the path to a directory where the print jobs will be spooled for this queue. You must create a unique spool directory for each printcap entry.

`log_file_name`—This is the path to a file where error information from the LPD will be logged.

➔ **Example** • Your printcap entries might look similar to this:

```
Ascii_files|form.feed.Queue_on_Port_1:\
:lp=:mx#0:rm=pserver1:rp=MYQUEUELF1:\
:sd=/usr/spool/myqueuel1:\
:lf=/usr/spool/myqueuel1/queue.log
```



**Important** • Each printcap entry must have a different spool directory to work properly.

# System V Queue Installation

## Configuring Operating System V Queue for ZebraNet Printing

This section describes the configuration of the printing system on the UNIX operating system. For clarity and brevity, the following specific names are used to represent general devices or concepts.

`lj4`—The local queue name on the UNIX system to which you want PSII print jobs directed.

`ZEBRAPRINTER`—The host name or IP address of the remote system that is the PSII device. For example, to Telnet to the PSII and invoke the PSII configuration utility, you would enter:

```
Telnet ZEBRAPRINTER
```

A host name is not required for the PSII—the IP address can be used.

`yourqueuename`—This is the name of the queue on the ZebraNet and must end with `LF1`.

## Prerequisites

Before you proceed, the following prerequisites must be met:

- The name `ZEBRAPRINTER` and the IP address assigned to the PSII are in the `/etc/hosts` file on the UNIX system.
- The LPD must be running on the UNIX system.

## UNIX Configuration

**To configure the UNIX machine so users can spool print jobs to the PCL print queue on the ZebraNet named `ZEBRAPRINTER`, complete these steps:**

- 1 Log in to the UNIX machine as root.
- 2 Type:

```
lpsystem -t bsd ZEBRAPRINTER
```



**3** Type:

```
lpadmin -p lj4 -s ZEBRAPRINTER!yourqueuname - I any
```

**4** Type:

```
accept lj4
```

**5** Type:

```
enable lj4
```

**6** Try printing by typing the command:

```
lp -d lj4 [filename]
```



## CHAPTER 6

# Using Printing Protocols

In this chapter you are given steps to set up your PSII to support **I**nternet **P**rinting **P**rotocol (IPP). Also, an exercise is provided to experiment with **F**ile **T**ransfer **P**rotocol (FTP) support.

### Content

IPP .....	72
FTP .....	73

# IPP



**Important** • You must have IPP support on your system.

IPP is an application-level protocol used for distributed printing over the Internet. Using IPP from any standard IPP client, you can transfer jobs to a printer that is connected to your ZebraNet PSII device and the Internet.



**Important** • IPP support is not available on all PSII printers. To be certain you are running the latest version of firmware, visit our Web site:

[www.zebra.com](http://www.zebra.com)

## To set up your PSII to support IPP, complete these steps:

- 1 Open a browser.
- 2 Enter the PSII IPP URL as follows:

```
http://xxx.xxx.xxx.xxx:631/ipp/port1
```

xxx.xxx.xxx.xxx = the IP address of the PrintServer II device

:631 = a fixed value

/ipp = a fixed string designating IPP

/port1 = a fixed value



**Example** • Your address might look like this:

```
http:198.60.248.120:631/ipp/port1
```



**Note** • Because IPP does not have an official standard, usage depends entirely on the quality of the IPP client and server.

# FTP

Embedded within the PSII is an FTP server application that processes file transfers from a host computer to the printer.

If the printer is on a network, label formats can be generated and data can be transferred without setting up a print queue.

## To send information to the printer in a Windows environment, try this alternative exercise:

- 1 In a text editor, generate the following ZPL II code:

```
^XA
^FO100,100
^CF0,55^FDZebra Technologies^FS
^XZ
```

- 2 Save the file and name it `test.txt`.
- 3 Open the MS-DOS Command Prompt and type:

```
ftp <IP of PrintServer II>
```

 **Example** • If the IP address of your PSII device is 12.3.4.123, you would type:

```
ftp 12.3.4.123
```

This opens a session with the FTP server.



**Note** • The default user name is blank.

- 4 Type your user name and press **Enter**.
- 5 Type:

```
put test.txt
```

This transfers `test.txt` to the printer, and the printer generates a label.

- 6 To terminate the FTP session, type:

```
quit
```



## Using Printing Protocols

FTP

## APPENDIX A

# PrintServer II

This appendix provides you with details on the PSII features that were not covered in the chapter *Getting Started on page 27*.

### Contents

PSII Features .....	76
---------------------	----

## PSII Features

This section covers features available for the PSII *only*, not the printer's features. Some of the features you access in this section prompt you to enter the default user ID and password, as follows:

- **User ID:** admin
- **Password:** 1234

The options on the [Print Server](#) page vary. ZPL and EPL printers print server settings vary slightly.



**Note** • The difference between **ZPL** and **EPL** is this:

- **ZPL**—If you have a ZPL printer, you are initially prompted to the *Printer Home* page, and from there, you select [Print Server Settings](#).
- **EPL**—If you have an EPL printer, you are immediately prompted to the *Print Server* page.

## Status and Configuration

The steps that follow are based on the navigation of a ZPL printer using firmware X.10 or higher.



**Important** • You can upgrade your firmware by visiting our Web site:

<http://www.zebra.com>

**To access the print server settings, complete these steps:**

- 1 Open a Web browser.
- 2 In the *Address* text-box, type your printer's IP address, and press Enter.



The *Printer Home Page* opens:

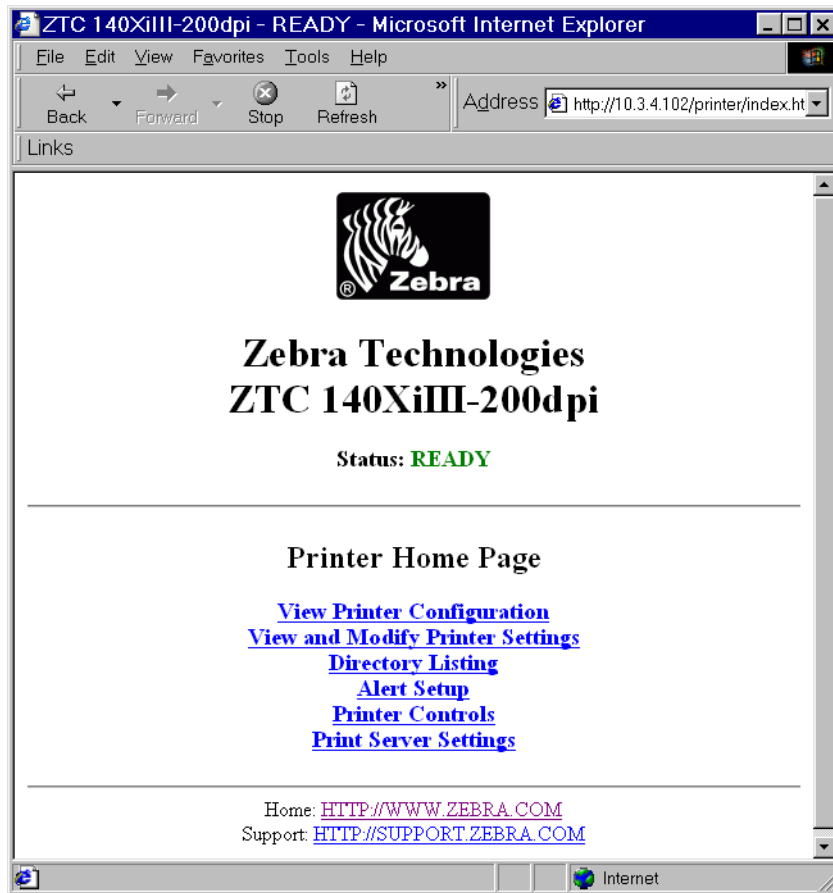

- 3 From the *Printer Home Page*, click [Print Server Settings](#).



**Important** • The illustration of the [Printer Server Settings](#) page is based on a ZPL printer. If you have an EPL printer, the menu options on the Print Server page are slightly different.

The *PrintServer* page opens:

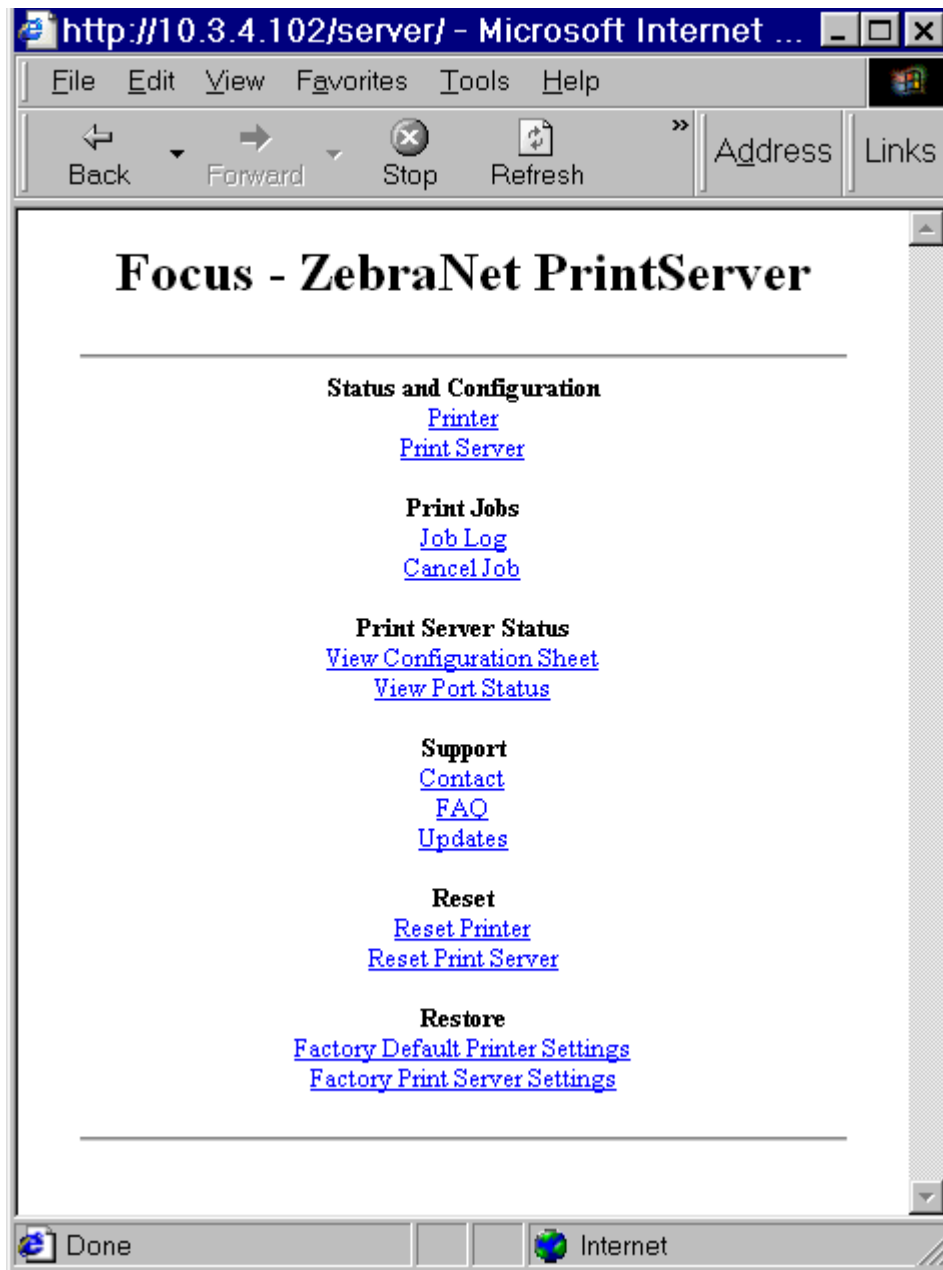

- 4 From the *PrintServer* page, click [Print Server](#).

The *Print Server Configuration* page opens:

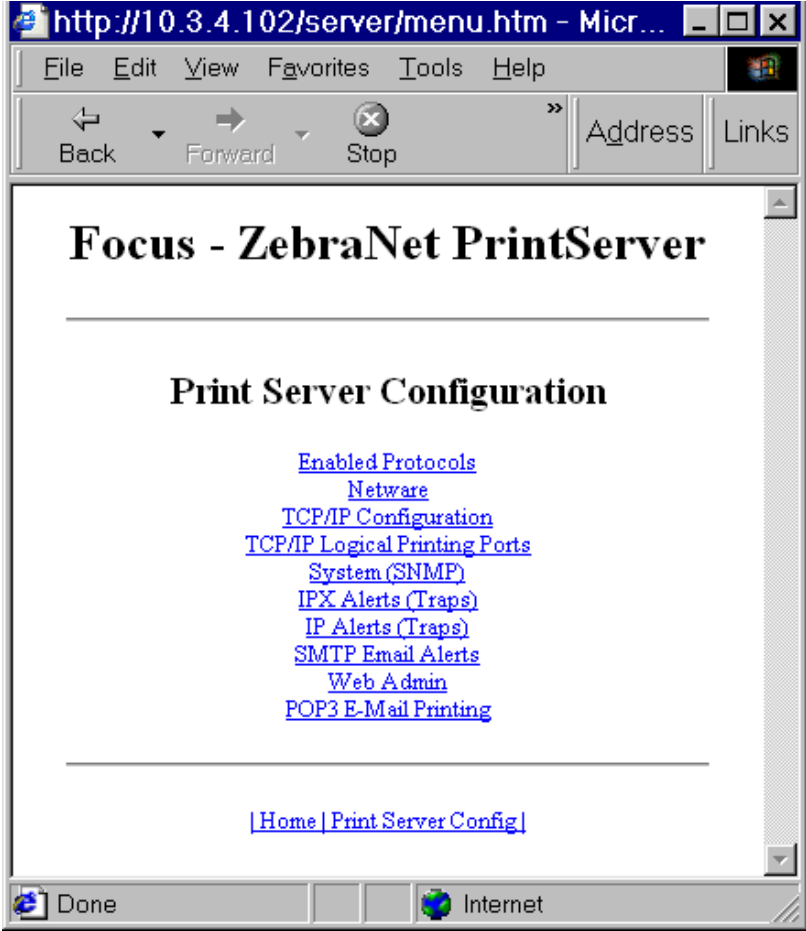

- 5 In the *Print Server Configuration* page, you have a menu to choose from. The table that follows identifies what each menu option page looks like:

### Enabled Protocols

Modifies the protocols to be used.  
NetWare, HP JetAdmin, or both.

Enabling HP JetAdmin Support allows status from the Zebra device to display in Hewlett-Packards HP JetAdmin utility.

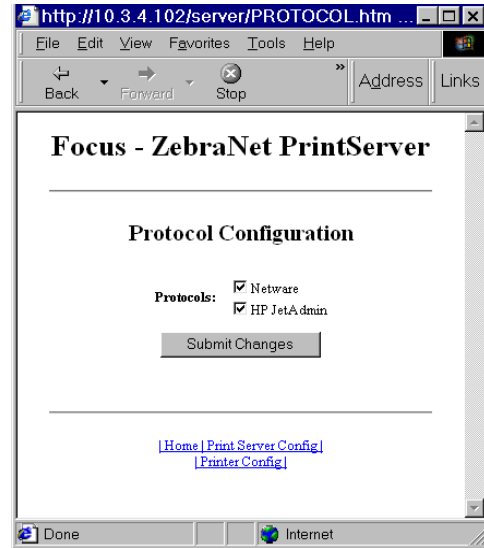

### Netware

*Preferred Tree*—Enter the tree that the printer is in.

*Print Server Name*—Enter the name of the printer.

*Disable NetWare SAP*—Enables or disables the broadcast SAP (Service Advertising Protocol) messages. Typically, SAP is enabled. If SAPs are disabled, the print server does not appear in the bindery and is not discovered by ZebraNet View. Disabling SAPs reduces network traffic, however, SAPs should be disabled, only on networks using NDPS exclusively or NetWare 5 over the IP protocol.

*NetWare Frame Format*—You can select how the frames for the data packets are assembled. The default is Automatic Sensing.

For details, see Help.

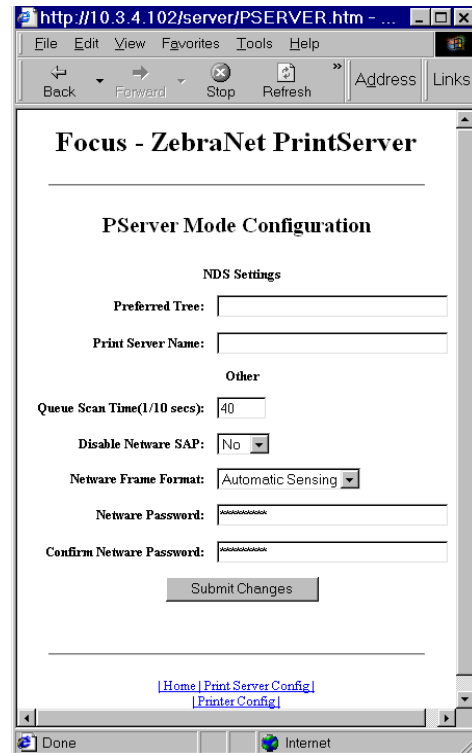

## TCP/IP Configuration

You can change the TCP/IP Configuration of the PSII.

For details, see Help.

The screenshot shows a web browser window displaying the 'Focus - ZebraNet PrintServer' configuration page. The page title is 'TCP/IP Configuration'. The form contains the following fields and options:

- IP Address:** 10.3.4.102
- IP Address Resolution:** Dynamic
- Dynamic Protocols:**
  - RARP
  - BootP
  - DHCP
  - Gleaning
  - Default Address
- Subnet Mask:** 255.255.255.0
- Default Gateway:** 10.3.4.1
- WINS Server IP Address:** 10.3.1.15
- Connection Timeout Checking:** Yes
- Timeout Value (secs):** 300
- ARP Broadcast Interval (mins):** 0
- Base Raw Port Number:** 9100

A 'Submit Changes' button is located at the bottom of the form. At the bottom of the page, there are links for [Home](#), [Print Server Config](#), and [Printer Config](#). The browser's status bar shows 'Done' and 'Internet'.

### TCP/IP Logical Printing Ports

Logical printers allow you to set up multiple pre- and post-processing configurations for each output port. Each logical port configuration can do the following:

- Add user-configured strings before and after the print data.
- Remove unwanted characters from the beginning of the print data.
- Four logical printer configurations are supported for each output port on the printer. The configurations can be assigned to any port, and all of these configurations can be assigned to a single output port.

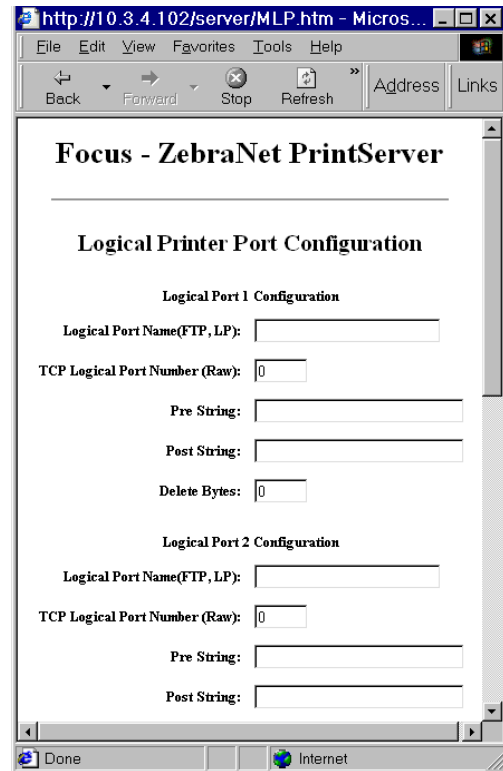

### System (SNMP)

This feature gives you the ability to manage multiple devices on a network, be it printers, computers, or other network-attached devices.

On this page you can define the SNMP system name, system location (PSII description), and other SNMP settings for your PSII.

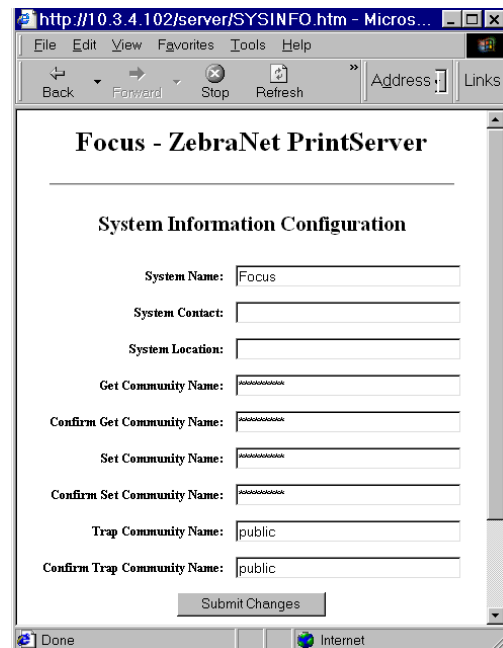

### IPX Alerts (Traps)

**I**nternet **P**acket **E**xchange (IPX) is Netware's network-layer protocol that handles networking addressing, routing, and packets.

This feature has you enter the IPX Network Address and IPX Node Address to which traps will be sent.

- To broadcast traps to all addresses on all networks, enter FFFFFFFF in the IPX Network address field and FFFFFFFFFFFFFFFF in the IPX Node Address field.
- To broadcast traps to all addresses on a specific local network, enter the network number in the IPX Network Address field and then FFFFFFFFFFFFFFFF in the IPX Node Address field.
- To disable traps, set all destination addresses to 0.

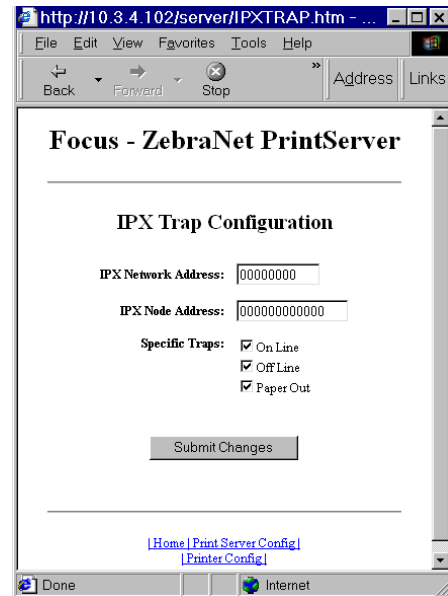

### SMTP Email Alert Configuration

This feature allows you to enter data regarding System Information on the network that is being used. Typically, a Network Administrator would use this.

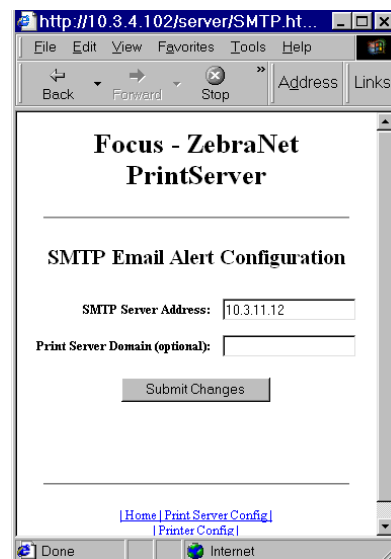

### Web Admin

This page allows you to configure the Admin name and password. Links to upgrades and support information can also be altered.

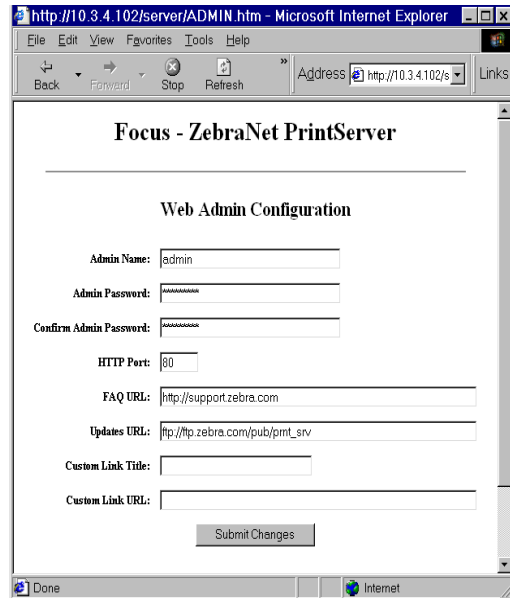

### POP3 Email Printing

This feature helps you set up the print server to receive email messages containing formats that can be printed. The POP3 settings must be set to retrieve emails from the email server.

**Warning** • Setting the POP3 polling interval (seconds) below 30 can cause communication problems with the POP3 server.

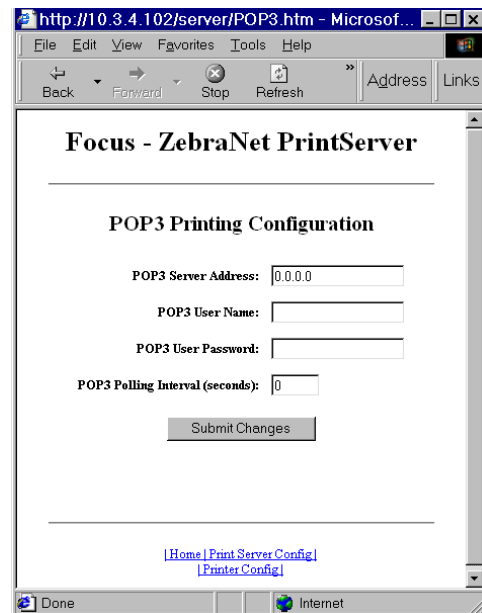

## Print Server Status

From the *Print Server* page, in the **Print Server Status** section you can access PSII's configuration sheet and port status.



**To open PSII's configuration sheet, complete this step:**

- From the *PrintServer* page, click [View Configuration Sheet](#).

This page opens:

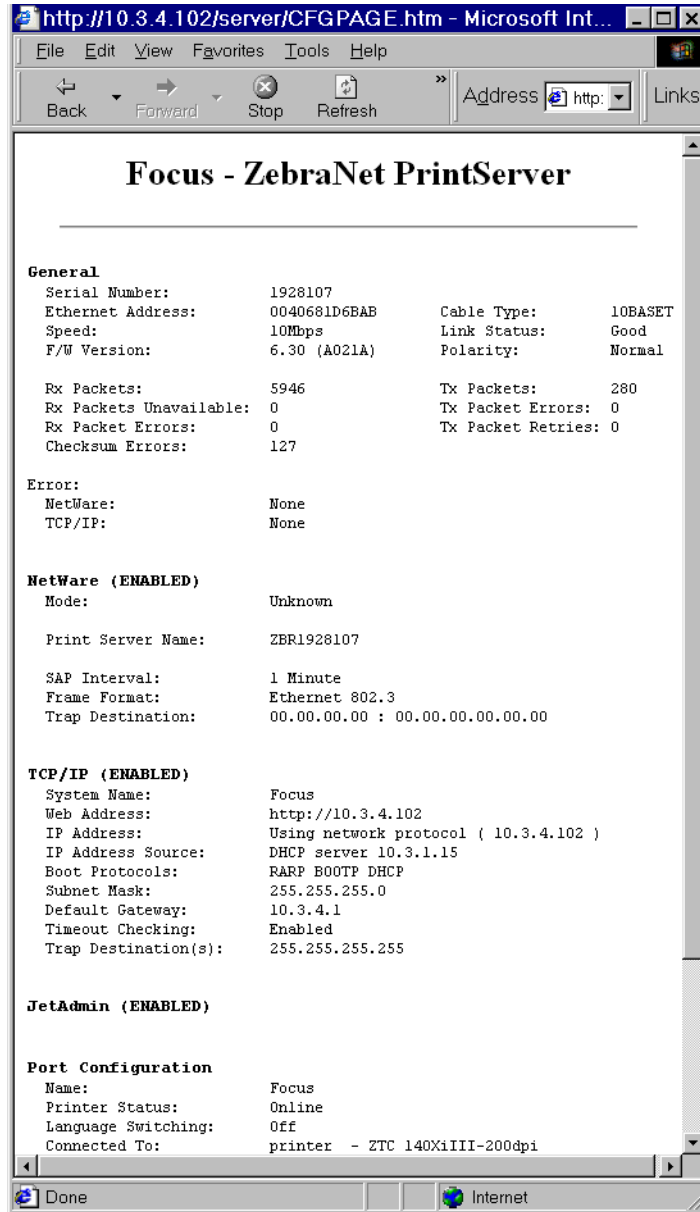

## To view the port status, complete this step:



**Important** • The default user ID and password is required to access this page.

- From the *Print Server* page, click [View Port Status](#).

The port status page opens:

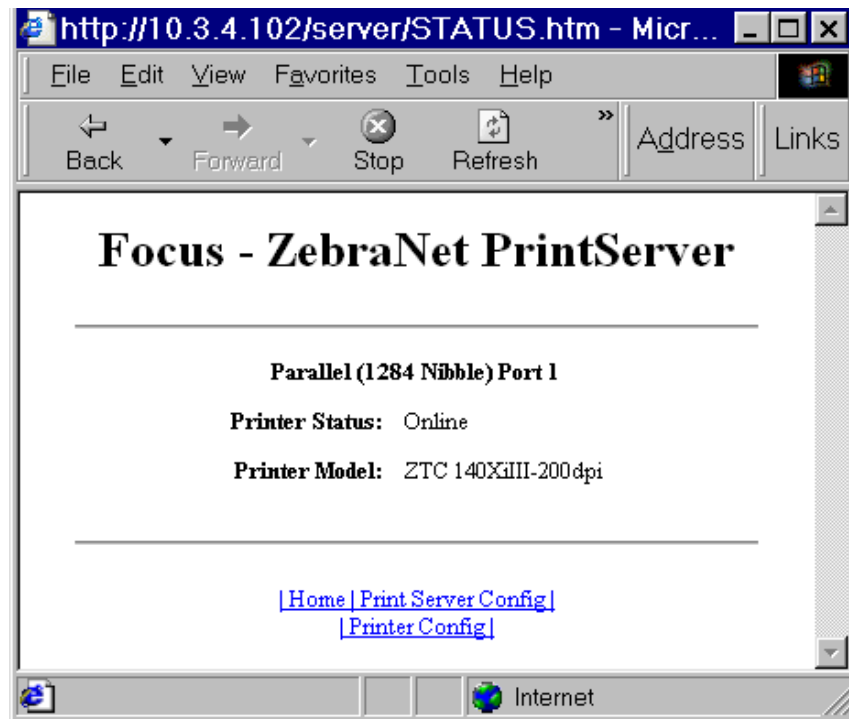

## Reset

From the *Print Server* page, in the **Reset** section you can reset PSII's configuration settings to what they were before you made the most recent changes.

## To reset the PSII, complete these steps:

- 1 From the *Print Server* page, click [Reset Print Server](#).

The *Reset Device* page opens:

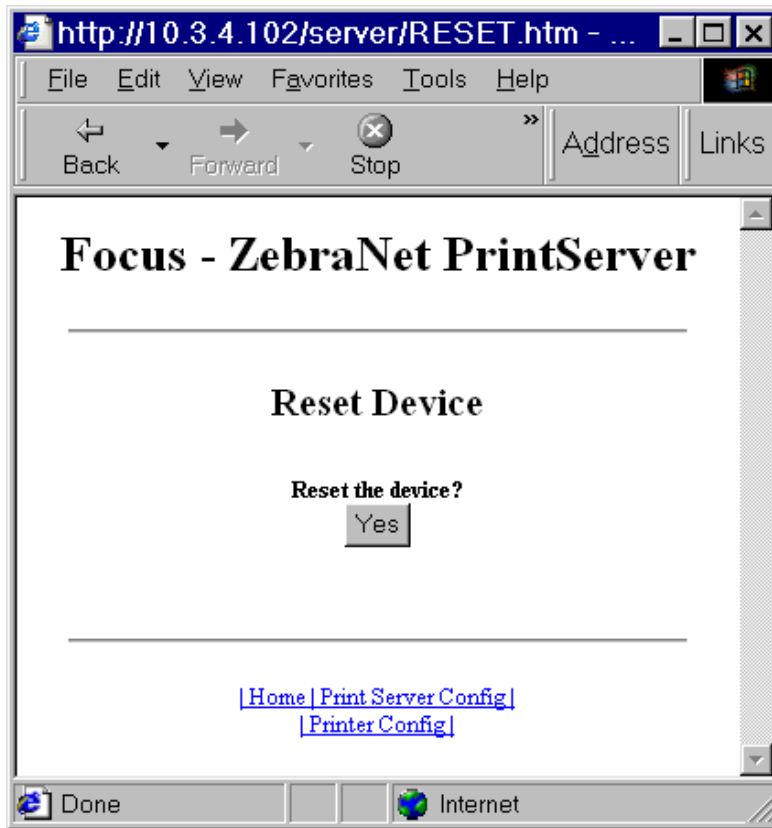

- 2 To reset PSII, click Yes.

## Restore

From the *Print Server* page, in the **Restore** section you can restore PSII's to the default factory settings:

**To restore PSII to the default factory settings, complete these steps:**

- 1 From the *Print Server* page, click [Factory Print Server Settings](#).

The *Restore To Factory Defaults* page opens:

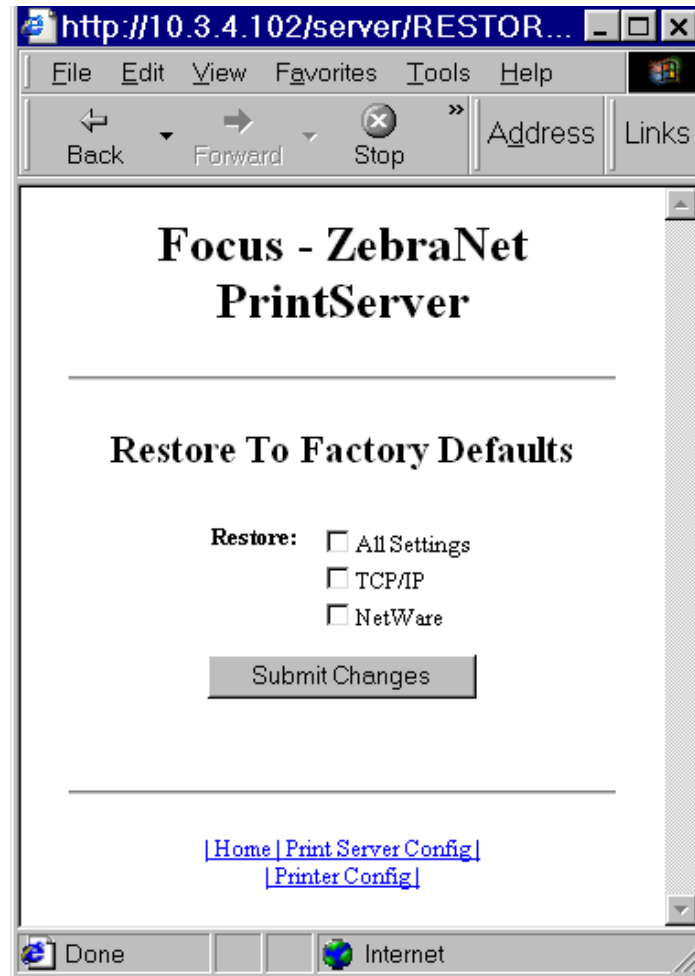

- 2 Make the selections you want, and click **Submit Changes**.

## APPENDIX B

# ZebraLink

The appendix provides you with detailed information that allows you to use the enhanced functionality of your ZebraLink-enabled printer with the PSII.

<b>Contents</b>	
WebView .....	<b>90</b>

## WebView

WebView gives the System Administrator or user who needs complete, easy, one-step control over the printing environment exactly what is needed. It provides real-time configuration, control, and monitoring capabilities with the convenient graphic interface of a Web browser.

The Web pages returned by Zebra printers are not static. They contain real-time information about the printer's present state of operation, including on-line status, error conditions, and all printing parameters.

## Home Page



**Note** • To access the printer's Web page, you need the IP address. For instructions on getting the IP address, see [Assigning an IP Address on page 30](#).

The Home Page is the first Web page that opens. It is a page with a menu of hyperlinks. Each hyperlink allows you to make modifications to the printer, PSII, and network settings; the other changeable settings through the Home Page include:

- Network Status, Error, and Warning reports
- ZebraNet PSII configuration
- Printer settings
- Directories of objects stored in Flash memory and RAM devices
- Objects, stored fonts, images, programs, and ZPL II formats
- Zebra Technologies support and home pages

### To open the WebView of your printer, complete these steps:

- 1 Open a Web browser.
- 2 In the *Address* text-box, type your printer's IP address, and press Enter.

The *Printer Home Page* opens:

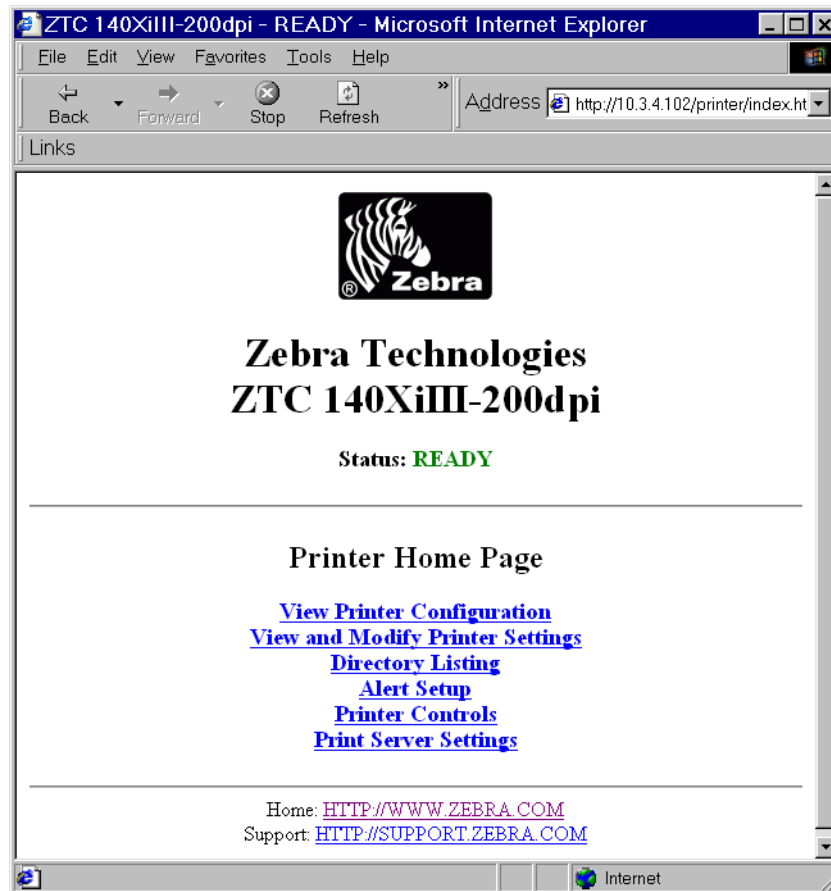

## View Printer Configuration

The View Printer Configuration menu option provides accurate, up-to-the-minute information on the printer's current state. An administrator can conveniently find any information on the Virtual Configuration Label and also check on the status of printer ports.

**To see the View Printer Configuration menu option, complete these steps:**

- 1 From the *Printer Home Page*, click [View Printer Configuration](#).

The WebView displays the configuration settings:

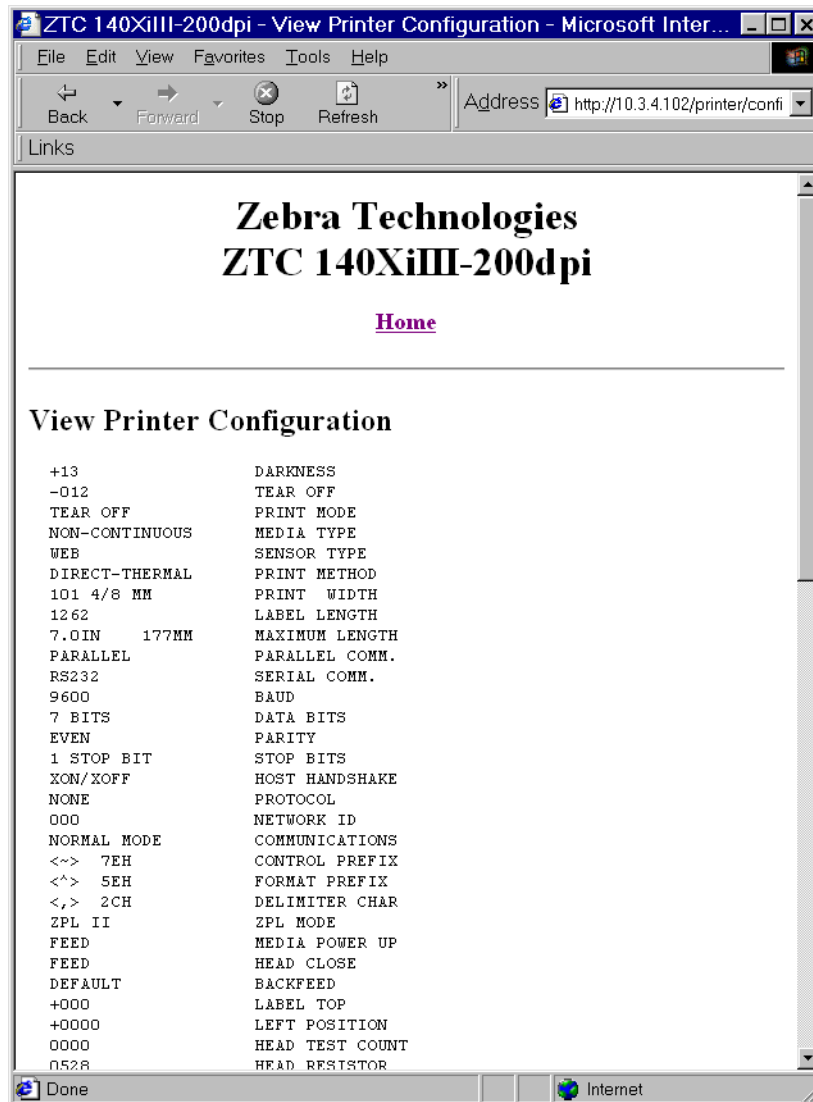

- 2 To update the printer information from this view:
  - For Netscape, select Reload and the printer sends current information to the Web browser.
  - For IE, click Refresh and the printer sends current information to the Web browser.
- 3 When you are finished reviewing:
  - To return to the Home page, click the [Home](#) link.
  - To print the label, scroll to the bottom of this page and click Print Label.



## View and Modify Printer Settings

This section provides you with steps for accessing and modifying printer settings with a ZebraLink-enabled printer. It also provides illustrations of the various pages you can access.



**Important** • To apply changes made in this section, you need to use the default user ID and password:

**User ID:** admin

**Password:** 1234

**To view the View and Modify Printer Settings, complete these steps:**

- 1 From the *Printer Home Page*, click [View and Modify Printer Settings](#).

The *View and Modify Printer Settings* page opens:

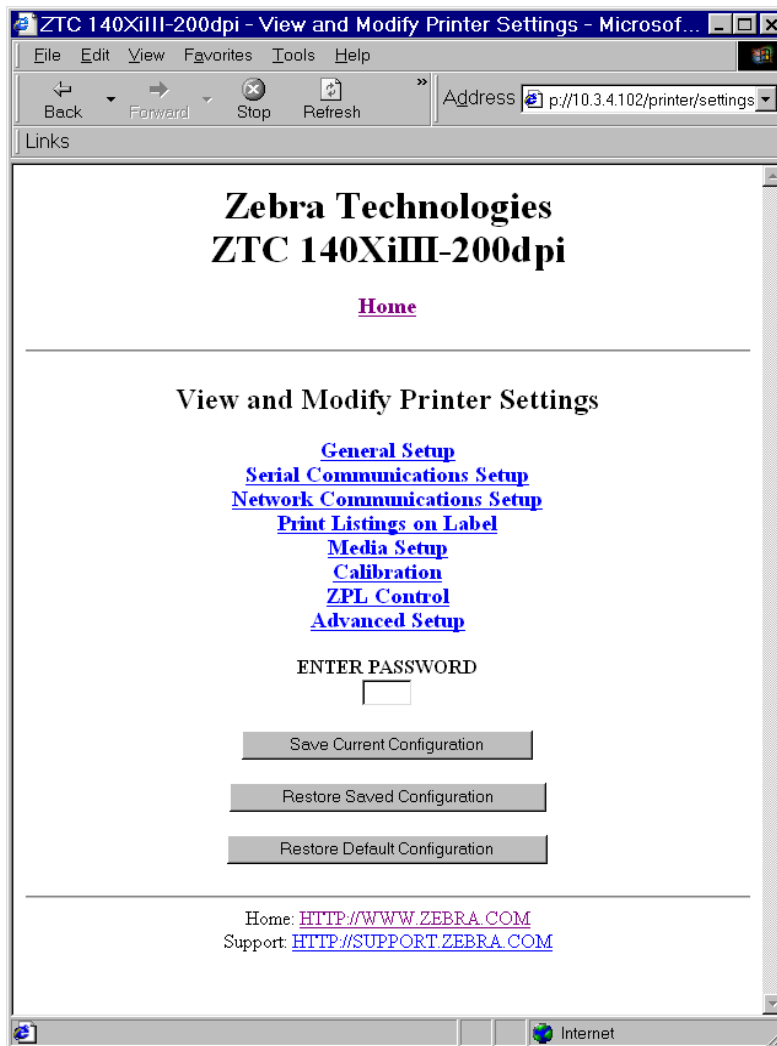

- 2 In the View and Modify Printer Settings page, you have a menu to choose from. The section that follows identifies what each menu option page looks like:

## General Setup

The screenshot shows the 'General Setup' page in a Microsoft Internet Explorer browser window. The address bar shows 'http://10.3.4.102/printer/setgen'. The page title is 'Zebra Technologies ZTC 140XiIII-200dpi'. Below the title is a 'Home' link. The main heading is 'General Setup'. The form contains the following fields and options:

- Printer Name:
- Printer Description:
- LANGUAGE:
- DARKNESS: Range 0 to 30,
- TEAR OFF: Range -120 to 120,
- PRINT MODE:
- LABEL TOP: Range -120 to 120,
- LCD ADJUST: Range 0 to 19,
- ENTER PASSWORD:

At the bottom of the form are two buttons: 'Submit Changes' and 'Reset Changes'.

## Serial Communications Setup

The screenshot shows the 'Serial Communications Setup' page in a Microsoft Internet Explorer browser window. The address bar shows 'http://10.3.4.102/printer/setcom'. The page title is 'Zebra Technologies ZTC 140XiIII-200dpi'. Below the title is a 'Home' link. The main heading is 'Serial Communications Setup'. The form contains the following fields and options:

- BAUD:
- DATA BITS:
- STOP BITS:
- PARITY:
- HOST HANDSHAKE:
- PROTOCOL:
- SERIAL COMM:
- NETWORK ID: Range 0 to 999,
- ENTER PASSWORD:

At the bottom of the form are two buttons: 'Submit Changes' and 'Reset Changes'.

## Network Communications Setup

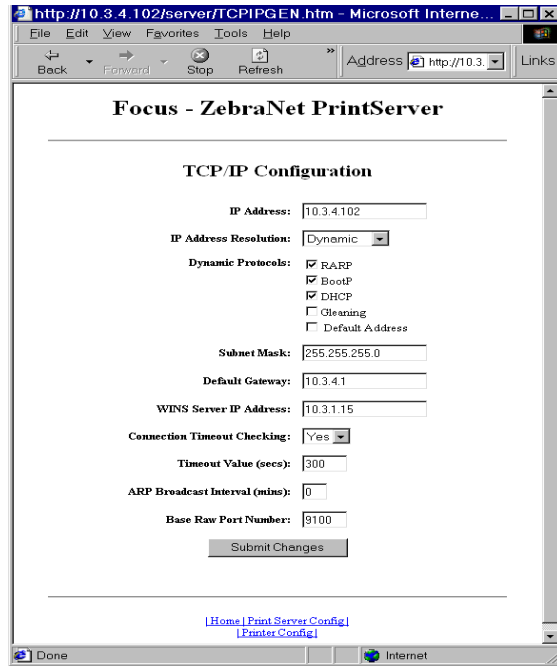

## Print Listings on Label



## Media Setup

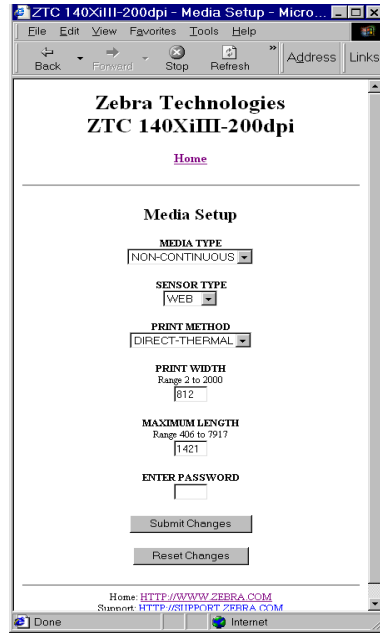

## Calibration

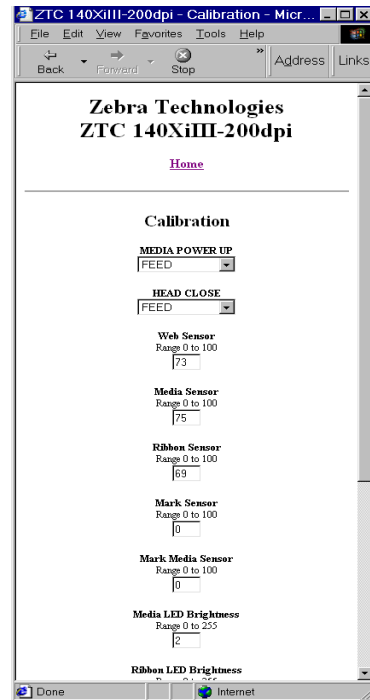

## ZPL Control

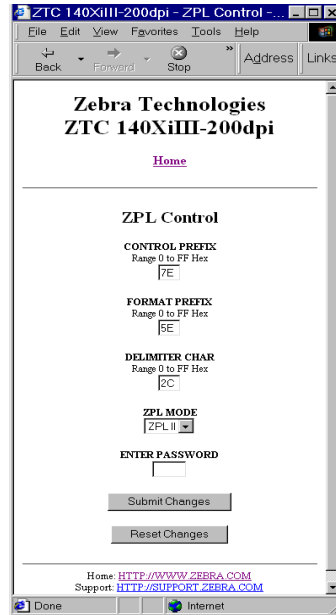

## Advanced Setup

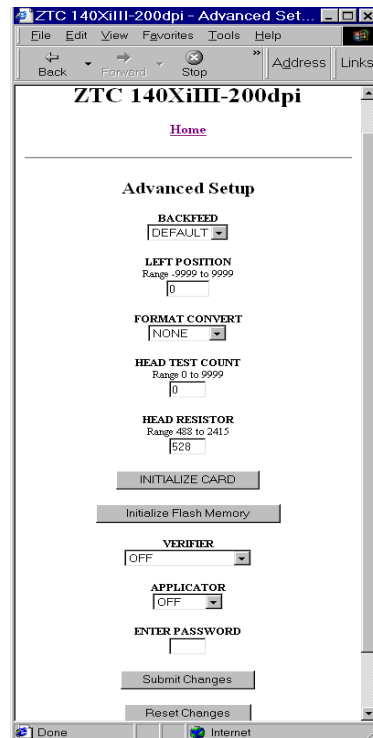

## Directory Listing

The directory page provides a listing of all file system devices (B:, E:, R:, Z:). The size, name, and location of each stored object appears.

Buttons are available to perform file management operations on the objects. The file management operations include:

- Delete object—Not available for objects in read-only memory (Z:).
- Copy object to a new name and/or device—Not available for objects that have the “protected” attribute set.
- Run a ZBI program—Available only if the object is a stored ZBI program. For details, see *Zebra BASIC Interpreter (ZBI) on page 105*.

### To view the Directory Listing, complete these steps:

- 1 From the *Printer Home Page*, click [Directory Listing](#).

This page opens:

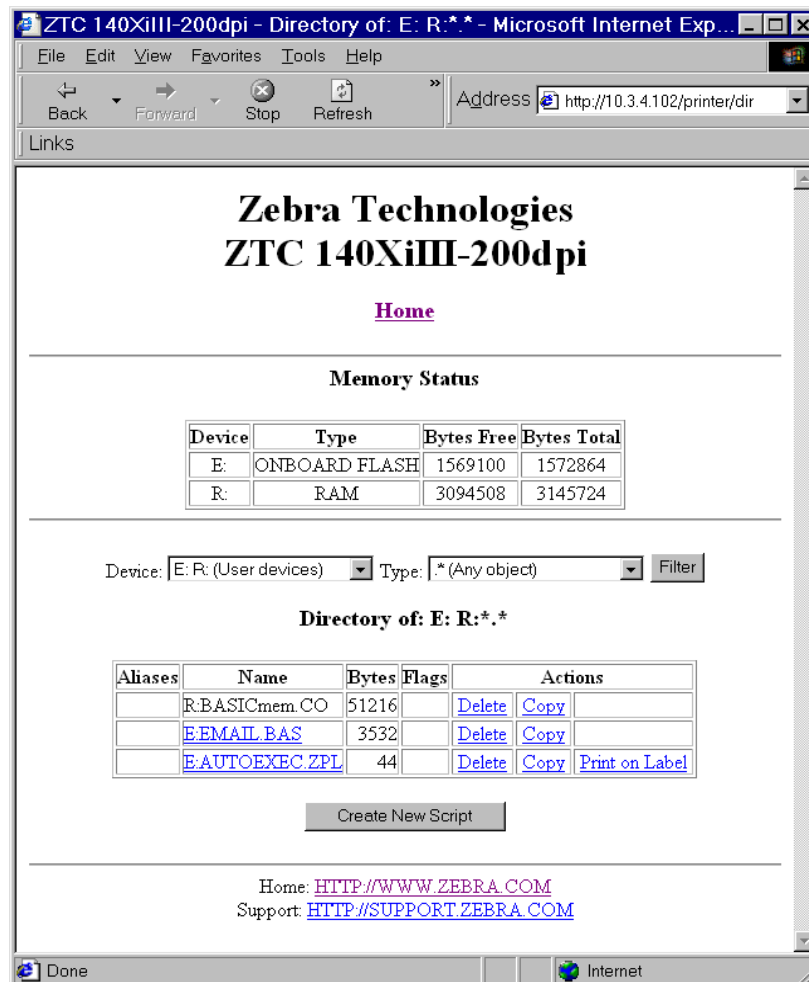

- 2 There are several links to select in this view.
- 3 To create a script, click **Create New Script**.

## Alert Setup

To configure the printer's interaction with ZebraNet Alert to be completely functional, SNMP settings must be established in these areas:

- The printer, via the WebView interface.
- The Alert Printer Management Utility for logging SNMP traps.

The ZebraLink messaging system provides for more than SNMP notification. Alert can be routed to various destinations:



- TCP
- UDP
- email
- serial port
- parallel port destinations

### To view Alert Setup, complete these steps:

- 1 From the *Printer Home Page*, click [Alert Setup](#).

The *Alert Messaging System* page opens:

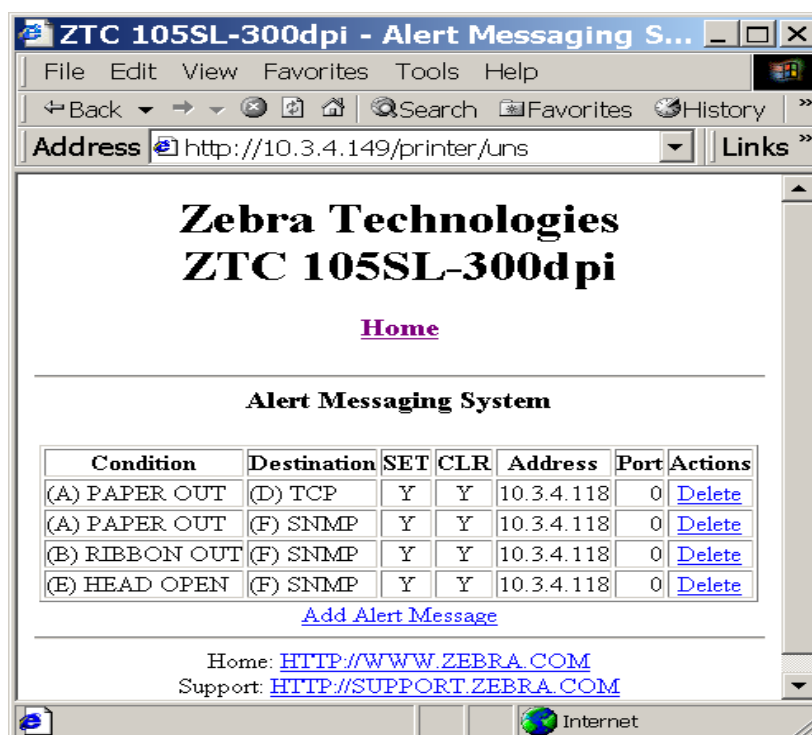

- 2 To add an alert, click [Add Alert Message](#).
- 3 Select accordingly.

## Establishing Email Alert Messaging

ZebraNet Alert supports email notification of printer errors sent directly to any valid email address. You can have multiple email addresses set up for routing different error messages, or split notifications between email and other network management tools.

**To begin receiving email notification of errors, complete these steps:**

- 1 From the browser, in the address text-box type in the printer's address.

The printer's home page opens.

- 2 From the *Printer Home Page*, click [Alert Setup](#).

The Alert Setup page shows a list of message notifications and their respective destinations.

- 3 From the *Alert Setup* page, email notification can be set up. Click [Add Alert Message](#).

The *Add Alert Message* page opens:

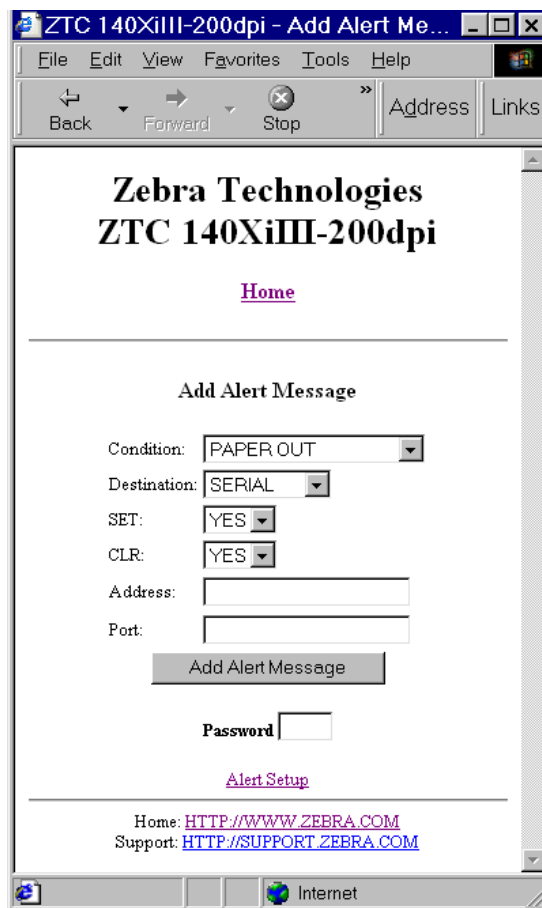



**Important** • The printer accepts only the last configuration made.

- 4 Specify the condition to send over email, such as HEAD ELEMENT BAD or PAPER OUT.
- 5 Enter a valid email address for the messages to be sent.



**Example** • `admin@yourcompany.net` (The Port field can be ignored for email setup.)



**Warning** • You must type in a password. If you forget to enter the *default* password, the alerts you just set are deleted.

- 6 Click **Add Alert Message**. Here you can continue to add more settings or, if finished, save the current settings.
- 7 From the Printer Home Page, select **PrintServer Settings>Network Communications Setup**.
- 8 Click **SMTP Email Alerts**.
- 9 Specify your SMTP server address.

When these steps are done, you can begin receiving email notification messages.

## Printer Controls

This page offers control over basic printer functions.

Other functions are also accessible from this page. These include:

- **Feed**—causes printer to feed one label.
- **Cancel One Format**—cancels the currently printing format.
- **Cancel All Formats**—cancels all formats.
- **Reset Printer**—causes printer to perform its standard reset without cycling power.

### To view Printer Controls, complete these steps:

- 1 From the *Printer Home Page*, click **Printer Controls**.

This *Printer Controls* page opens:



**Important** • In this view, you must have administrative rights to make changes to the printer controls.

## Print Server Settings

This section provides you with instructions for viewing the current printer settings.

**To view the print server menu, complete these steps:**

- From the *Printer Home Page*, click [Print Server Settings](#).

The *PrintServer* page opens:

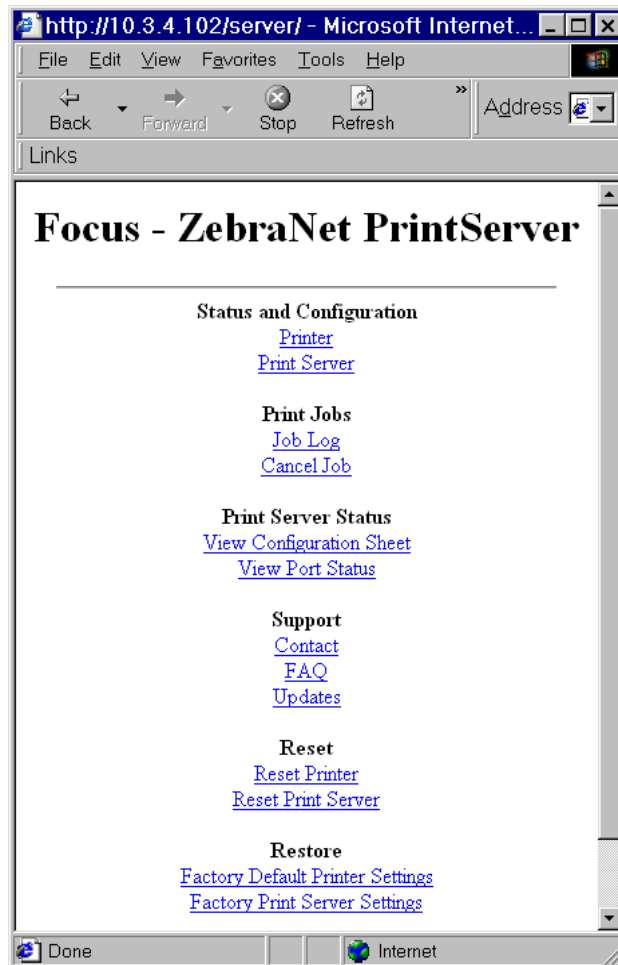

For more details on PSII, see *PrintServer II on page 75*.

## Zebra BASIC Interpreter (ZBI)

ZBI allows you to maximize printing options through custom programs written for your specific needs. ZBI programs can be viewed, modified, and run from the Directory Listing Page. *Directory Listing on page 99*.



## APPENDIX C

# ZebraNet Utilities

The appendix provides you with details on ZebraNet Utilities, the software suite of printer administration tools that complements and enhances both ZebraLink and the ZebraNet family of connectivity products.

### Contents

ZebraNet View.....	108
ZebraNet Alert .....	111
ZebraNet Connect.....	119
ZebraNet View Java Applet .....	120

# ZebraNet View

ZebraNet View allows you to locate printers automatically. It can search on parameters such as IP address, subnet, printer model, printer status, and many other user-defined characteristics. It also offers powerful device management capabilities.

## To open ZebraNet View Utilities, complete these steps:

- 1 From the task bar, select Start>Programs>ZebraNet Utilities>ZebraNet View.

The *ZebraNet View* dialog opens:

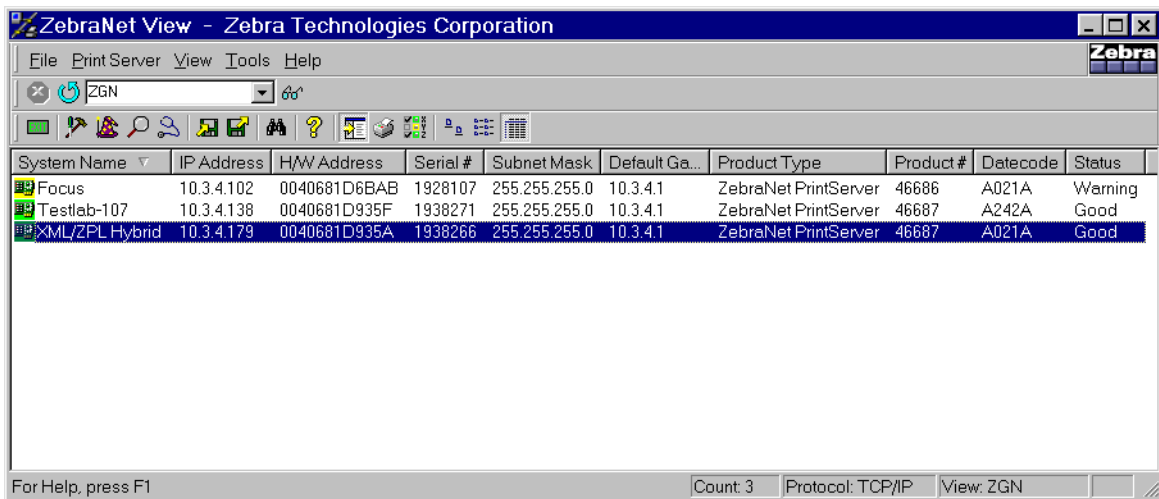

- 2 Select your printer.
- 3 From the menu bar, select PrintServer>Configuration.



The *Print Server Configuration* dialog opens:

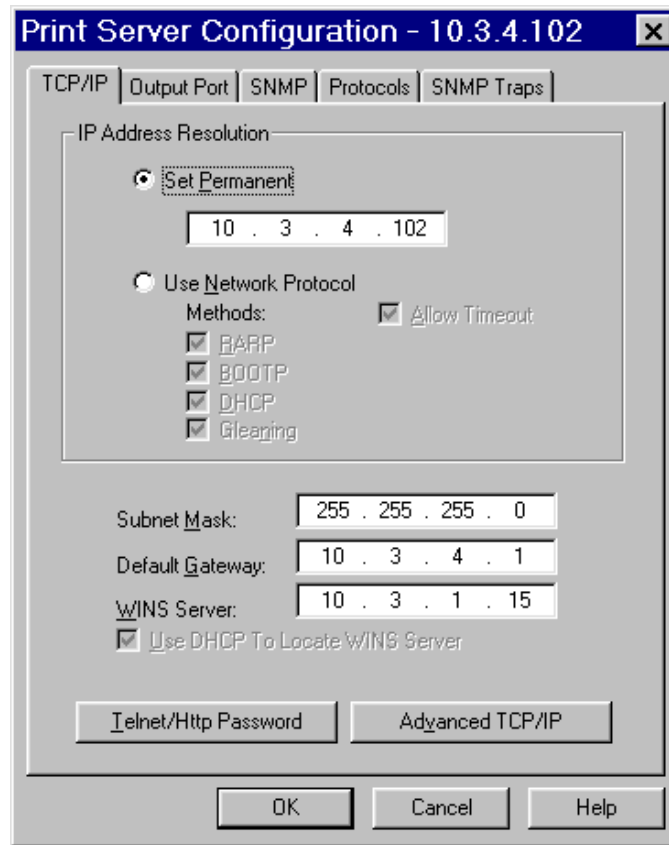

There are multiple tabs that you can access to make changes to current settings.

**To set alerts in ZebraNet View, complete these steps:**

- 4 From the *Print Server Configuration* dialog, click the *SNMP Traps* tab.

The *SNMP Traps* tab shows the alerts you can set.

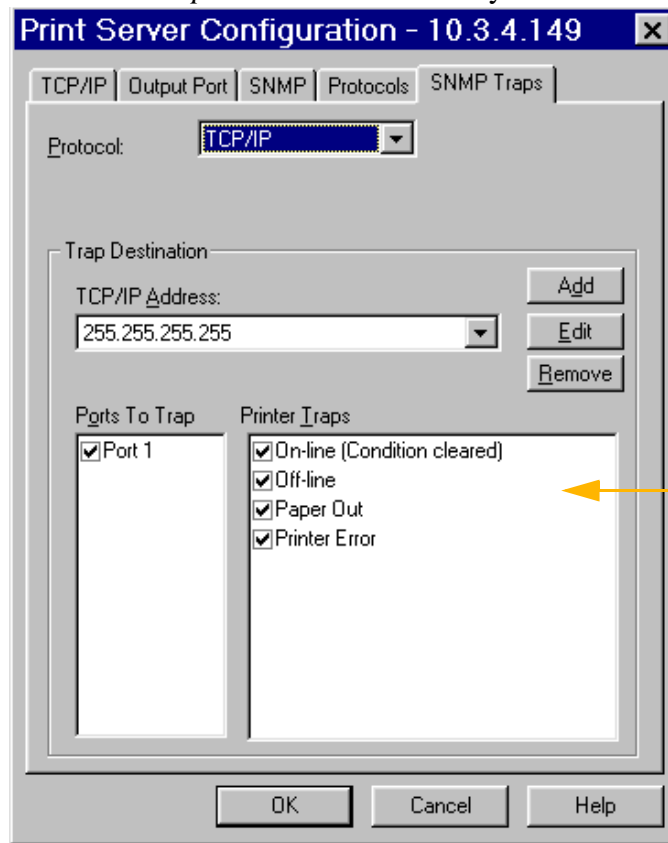

The check boxes in Printer Traps are the alerts.

- 5 To monitor the set alerts (printer traps), see [ZebraNet Alert on page 111](#).

# ZebraNet Alert

ZebraNet Alert gives you the ability to manage your Zebra printers by immediately notifying System Administrators of printer error or warning conditions. Using Web-based configuration tools, selected errors or warning conditions can be routed to a variety of services such as email messages, wireless pagers, or the ZebraNet Alert.

The following tables show the conditions that can trigger alerts:

## PSII Alerts

- 
- On-line (condition clear)
  - Off-line
  - Paper out
  - Printer error
- 

## ZebraLink Alerts

- 
- Media out
  - Ribbon out
  - Printhead over-temp warning
  - Printhead under-temp warning
  - Head open
  - Power supply over-temp
  - Ribbon warning (in direct-thermal mode)
  - Rewind full
  - Cut error
  - Printer paused
  - PQ job completed
-

- 
- Label taken
  - Head element out
  - ZBI (Zebra BASIC Interpreter) runtime error
  - ZBI (Zebra BASIC Interpreter) forced error
  - Power on
- 

## ZebraNet Alert Destinations

Unsolicited Alert messages can be directed to the following destinations:

- Email (PSII-specific)
- Serial (ZebraLink-specific)
- Parallel (ZebraLink-specific)
- TCP (PSII-specific)
- UDP (ZebraLink-specific)
- SNMP (PSII-specific)

## ZebraNet Alert Using SNMP

You can send notifications over SNMP only, for use with ZebraNet Alert or a similar network management utility.

**To configure the PSII to send alerts across a TCP/IP Network to ZebraNet Alert, complete these steps:**



**Important** • If you did not install ZebraNet Alert during the ZebraNet Utilities installation, see [ZebraNet Utilities on page 19](#).

- 1 From the task bar, select Start>Programs>ZebraNet Utilities>ZebraNet View.
- 2 Select the printer you want.
  - If a DHCP server is present, the PSII will already have an IP address.

- If no DHCP server is present, you might need to assign the printer an IP address.
- 3 To assign your printer an IP address, from the menu bar, select Print Server>Configuration.
  - 4 For PrintServer SNMP Traps, select the *SNMP Traps* tab.
  - 5 Enter the trap destination and options.

This tells the PSII what TCP/IP address to send the alerts to, and under what circumstances to send error and log reports. Entering 255.255.255.255 broadcasts the message to every host on the network with an SNMP program running.

- 6 For ZebraNet Alert to get and display the messages, you need to open ZebraNet Alert. To do this, follow these steps:
  - From the task bar, select Start>Programs>ZebraNet Utilities>ZebraNet Alert.



**Important** • The SNMP trap settings must be established to communicate with PSII if messages are sent to the ZebraNet Alert.

- In the *ZebraNet Alert* dialog, from menu bar, select View>Filter Settings.
- From the *View Filter - Devices* tab, choose your settings accordingly.



**Note** • If you select **No device filtering**, messages from every printer are caught; **Device Address** allows you to specify which IP address data will come from.

- The **View Filter - Events** tab allows you to select individual events you want the program to be aware of.



**Important** • Now PSII's SNMP Alert messages can be set up in WebView. From the printer's home page, activate the link to Alert Setup. You can add messages that are sent to the ZebraNet Alert for Windows by choosing SNMP as a destination.

## Sending Email to Your Zebra Printer

To easily transfer instructions and data to your printer from a remote location, PSII allows you to send email to the printer. This is set up under the link POP3 Email Printing. You need to provide the address of the network POP3 server, a user name, and a password.

With this option, you can create a text-based email containing ZPL II code and transfer it to the printer.



**Note** • Email attachments sent to the printer are not supported.

By using the proper ZPL II commands, files can be saved, loaded, printed, copied, and deleted, just as if the data were transferred from a serial or parallel port.

**To access POP3, complete these steps:**

- 1 From the Printer Home page, click [Print Server Settings](#).

The *PrintServer* page opens:

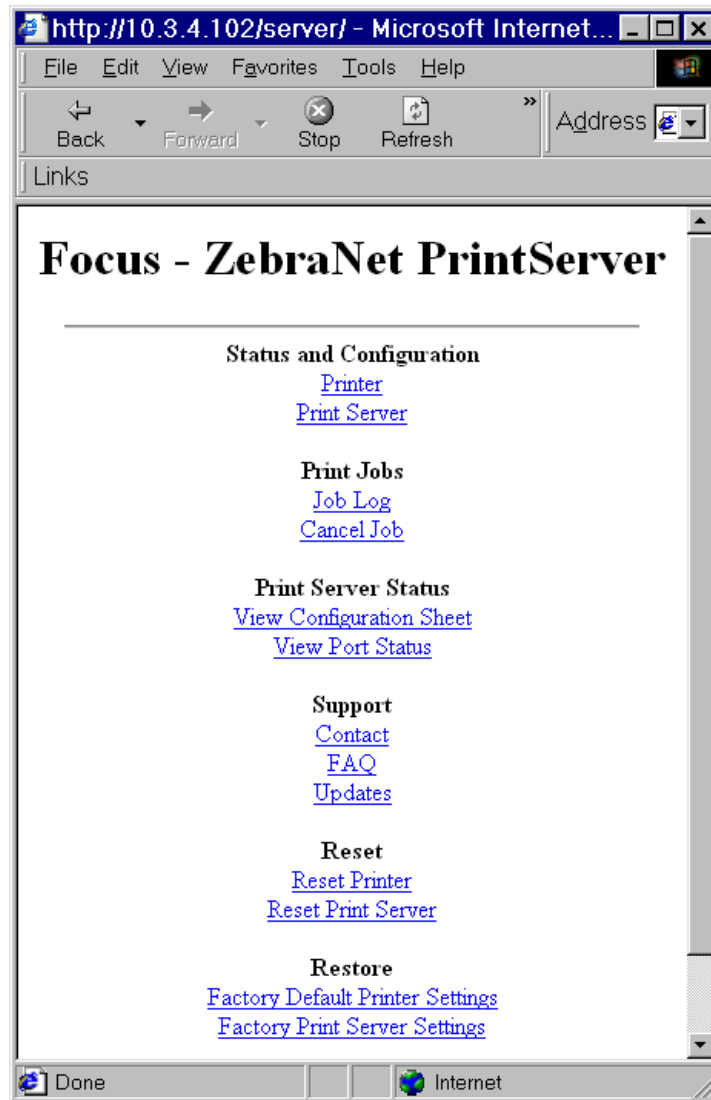

- 2 From the *PrintServer* page, click [Print Server](#).

The *Print Server Configuration* page opens:

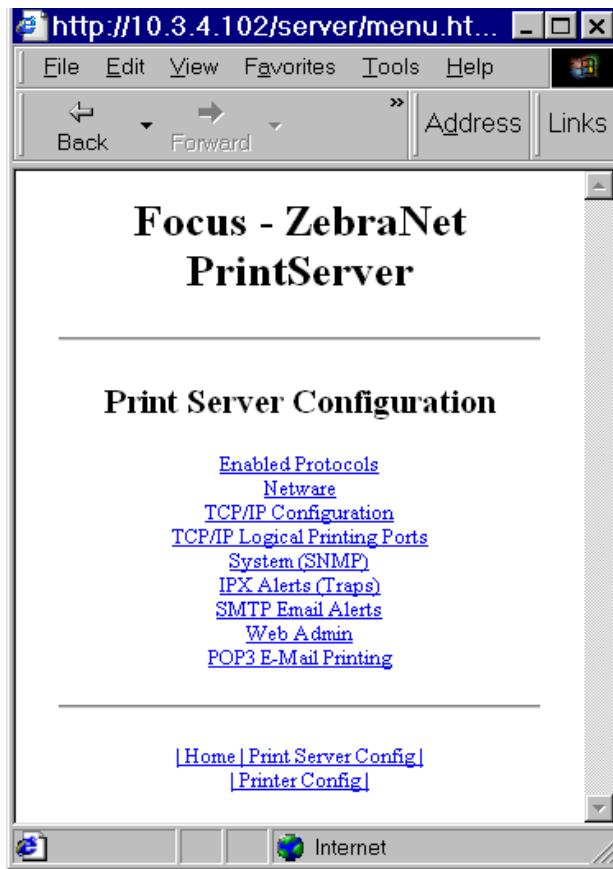

- 3 From the *Print Server Configuration* page, click [POP3 E-mail Printing](#).



The *POP3 Printing Configuration* page opens:

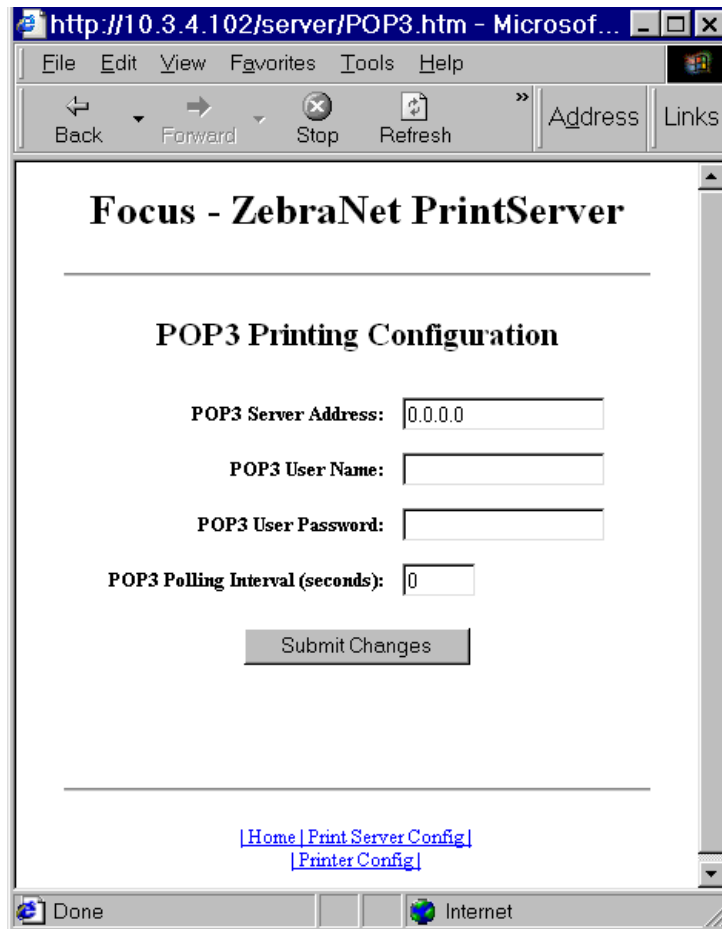

- 4 Make the necessary changes, and click **Submit Changes**.

ZebraNet Alert monitors status and activity of all Zebra printers on the network. It alerts the administrator when there is an error condition, which reduces printer downtime and increases application efficiency.

## Open Alert

**To open ZebraNet Alert, complete these steps:**

- 1 From the task bar, select Start>ZebraNet Utilities>ZebraNet Alert.
- 2 In the *ZebraNet Alert* dialog, from the menu bar select Report>. The report menu option has multiple report selections.
- 3 Select the type of report you want to generate.

This is an example of the *Event Summary* report. Notice it generates a .log file.

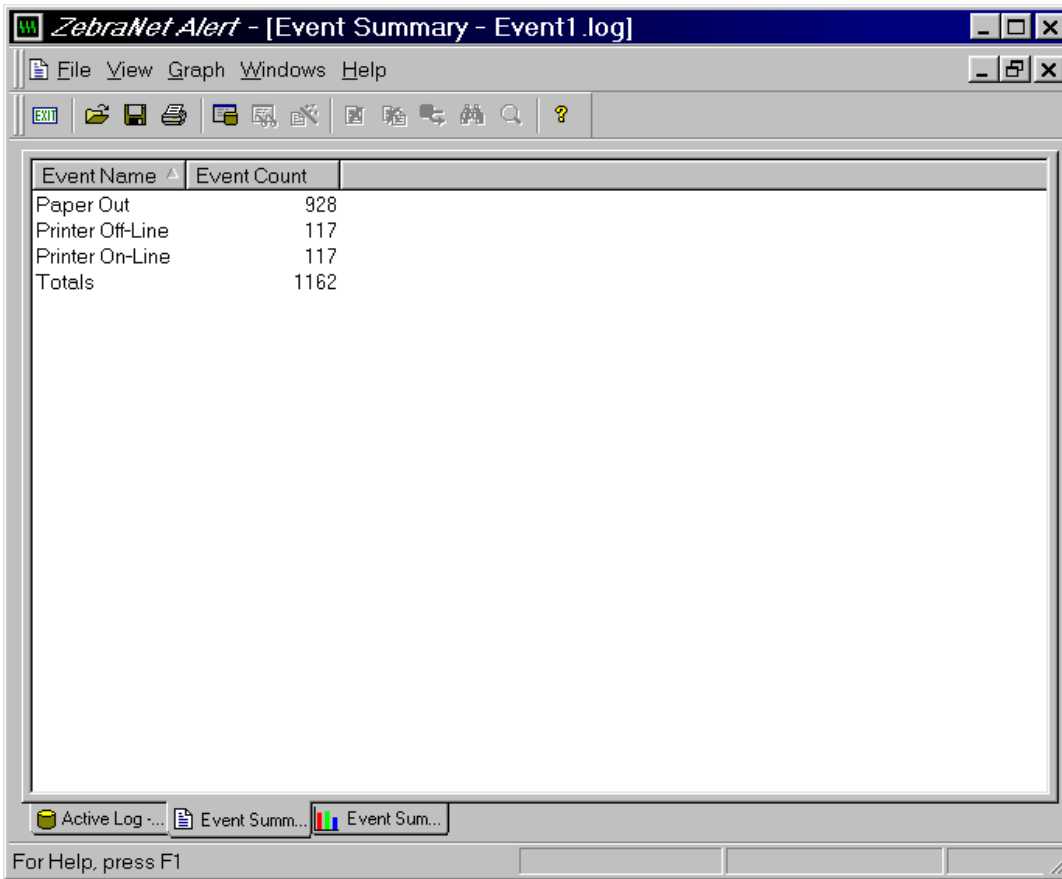

# ZebraNet Connect

For details, see [Setting up a ZebraNet Connect IP on page 49](#).

## ZebraNet View Java Applet

ZebraNet View Java Applet is a Java-based version of ZebraNet View. This can run on any enabled platform that can run a Java virtual machine, such as Windows, UNIX, Linux, and many others.



**Important** • To use this, you must have installed it with ZebraNet Utilities and then installed this application. For installation instructions for ZebraNet Utilities, see [ZebraNet View Java Applet on page 23](#).

### To access ZebraNet View Java Applet, complete these steps:

- 1 From the task bar, select Start>Programs>ZebraNet Utilities>ZebraNet View Java Applet 1.0.

This view opens:

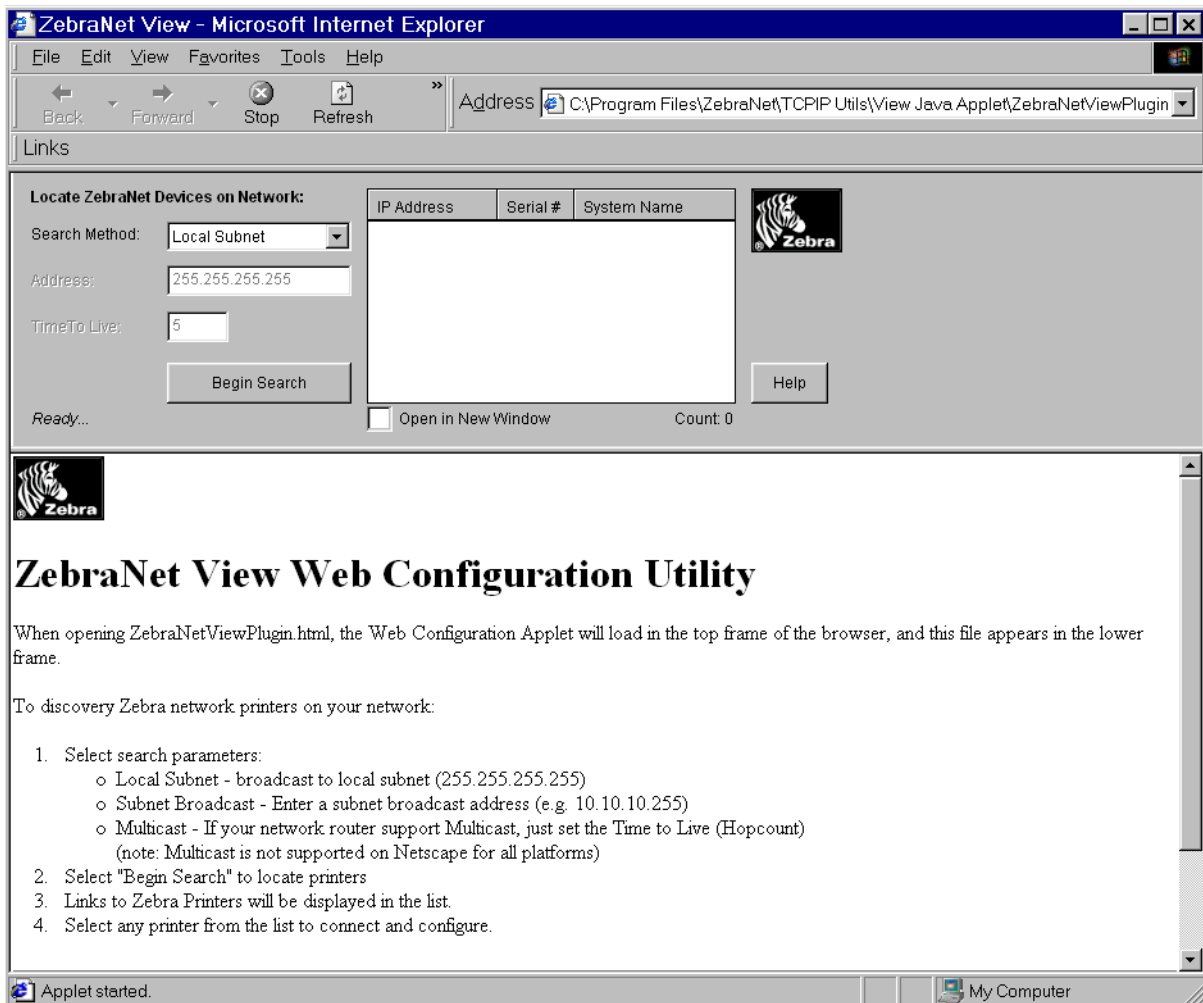

- 2 In the *Search Method* drop-down list box, select the search method you want.
- 3 Click **Begin Search**.

It searches your network for all networked Zebra printers, discovers them, and lists them.

- 4 When you select a device from the list that is discovered, the selected device's *Home Page* displays in the lower portion of the view (it replaces the *ZebraNet View Web Configuration Utility* content).





# Hardware Troubleshooting

This provides you with solutions to known issues.

## Contents

Resetting to Factory Defaults . . . . .	124
Status Indicator . . . . .	124
ZebraNet View Utility Discovery or Configuration Problems . . . . .	125
Unable to Print. . . . .	125
Unable to Configure Device . . . . .	126
HP JetAdmin or HP Web JetAdmin. . . . .	126

# Troubleshooting the PSII

## Resetting to Factory Defaults

To reset the PSII configuration parameters to the factory defaults, press the **Test** button and hold it in while turning the printer power on. Keep the test button pressed until the Status Indicator light turns green, then release the test button. After approximately 20 seconds, a configuration label prints automatically.

## Status Indicator

A bi-color Status Indicator displays the operational status of the PSII. The following conditions might occur:

- During normal operation, the LED is solid green for more than 30 seconds. This indicates all the hardware is functioning properly and it has detected the presence of the network. It does not mean the PSII has an IP address or is attached to a printer queue.
- If the LED is rapidly flashing green (9 times/sec), the PSII has not detected the presence of a network cable. To solve the problem:
  - Turn the printer power off. Remove the network cable from the PSII. Plug the network cable back in until you hear a positive click. Check the other end of the cable in the same manner. Turn the printer power on. If the PSII still does not detect a cable, continue.



**Important** • Cables with a rating higher than CAT-5 have **not** been tested.

- Verify that the network cable is 10BASE-T and has an RJ-45 connector.
- Connect the PSII to a network drop that is a known good network connection. If the PSII is still unable to detect the network cable, contact Technical Support for assistance.
- If the LED is slowly flashing green (1 time/sec), the PSII is trying to print a job. If the job does not print, check the following:
  - Verify that the printer has media and ribbon (if in thermal transfer mode). If the printer is showing any errors, it is unlikely that the PSII can send data to the printer. The LED continues to blink until the printer malfunction is resolved or until the printer is turned off.



- Flashing red indicates the Power On Self Test (POST) is in progress.
- If the LED is solid red for more than 30 seconds, the PSII has failed the POST. If the failure is not severe, the PSII attempts to print a configuration label on the printer. A failed POST can be caused by any of the following:
  - The printer attached to the PSII device is malfunctioning. Turn the printer power off, wait 10 seconds, then turn the printer back on.
  - If the PSII still fails the POST, continue below. The PSII has a hardware problem that can be fixed only by replacing or returning the unit. Contact Technical Support for repair or replacement information.
- If the LED is alternately flashing red and green for longer than 2 minutes, the PSII is in firmware-download mode. This means it is waiting for new firmware data to be sent before it continues normal functioning. Perform the following:
  - If the PSII was purposely put into firmware-download mode, finish the download with the proper update utility. Contact the Zebra Web site at <http://www.zebra.com> to download this utility.
  - Contact Technical Support for help recovering this unit.

## ZebraNet View Utility Discovery or Configuration Problems

If you are having problems using the ZebraNet View utility to discover or configure the unit, check the following:

- Verify there is not a router between the workstation running ZebraNet View and the PSII. Because the PSII does not have an IP address, TCP/IP communication cannot be started across a router. Run ZebraNet View on the same subnet as the PSII. This is not a limitation when using ZebraNet View for HP JetAdmin in IPX/SPX Discovery Mode.
- Verify the PSII has a solid green light. If the LED shows a rapidly flashing green light, check the network cable that is attached.

## Unable to Print

- If you are having problems printing, verify that there is communication between the PSII and the printer. Check the following:
  - Print a configuration label by pressing the test button on the PSII. If a configuration label does not print, verify the printer has media and ribbon (if used) and is not paused.
  - If problems persist, contact Technical Support.

## **Unable to Configure Device**

To assign an IP address to a ZebraNet PSII using ZebraNet View, you must be on the same subnet. If ZebraNet View has Multicast enabled, you might be able to view the ZebraNet PSII on another subnet, but you will not be able to configure the device.

## **HP JetAdmin or HP Web JetAdmin**

The ZebraNet PSII might be set up and managed using HP JetAdmin or HP Web JetAdmin products.



# Frequently Asked Questions

This is a group of frequently asked questions (FAQs) about PSII.

# FAQs

This table provides frequently asked questions (FAQs) on PSII:

Question	Answer
<p><b>Are there any differences in functionality between a ZebraNet PSII with an EPL-based printer and with a ZebraLink-enabled ZPL printer?</b></p>	<p><b>Yes.</b></p> <ul style="list-style-type: none"> <li>• In a ZebraLink environment, with either a Web browser or with the ZebraNet View Utilities, there are a variety of Web pages that display a wealth of status information regarding both the ZebraLink printer and its ZebraNet PSII. However, when used with an EPL printer, such as the LP/TLP 2844, the Web pages for printer status are not available at this time, only the Web pages showing status of the PSII are displayed. The PSII can be easily configured. However, printer configuration information regarding the EPL printer is not available via the ZebraNet Utilities.</li> <li>• Error conditions: Using ZebraNet Alert, an EPL printer can be configured to use different IP addresses to report the following Alert status conditions: on-line, off-line, paper out.</li> <li>• For EPL: only two destinations can be configured to report error messages (online, offline, and paper out) using SMTP email alert – serial and parallel port destinations are not supported.</li> </ul>
<p><b>Can the internal ZebraNet PSII option work on a computer network that is running both TCP/IP and IPX protocols simultaneously?</b></p>	<p><b>Yes.</b></p> <p>The ZebraNet PSII runs all of its available protocols simultaneously. This means that the ZebraNet PSII can run on mixed networks such as a network using Microsoft, UNIX, and Novell NetWare operating systems.</p>

Question	Answer
<p><b>Will the ZebraNet PSII allow connectivity to anything other than a PC network?</b></p>	<p><b>Yes.</b></p> <p>The ZebraNet PSII allows connectivity to systems such as IBM's AS400, provided that it is configured using TCP/IP. Other network protocols can be used with third-party adapters that are converted to 10BASE-T.</p>
<p><b>Will the ZebraNet PSII option work on a 10BASE-T per second network?</b></p>	<p><b>No.</b></p> <p>The ZebraNet PSII option is a 10BASE-T print server. This means that the data cannot travel any faster than 10 megabits per second. The ZebraNet PSII can be deployed on a network that is utilizing 10/100 hubs, but the ZebraNet PSII operates at only 10 megabits per second.</p>
<p><b>What if a print job makes it to the queue, but never leaves the queue? The label does not print.</b></p>	<p>These are the things to check:</p> <ul style="list-style-type: none"> <li>• Confirm that the printer is turned on and receiving power.</li> <li>• Confirm that the network cable is plugged in and that you can ping the printer.</li> </ul> <p>If the above bullets do not change the outcome, it is likely that there was a misconfiguration while creating the queue. The queue must be recreated verifying the following:</p> <ul style="list-style-type: none"> <li>• Confirm that you use the print server's valid IP address.</li> <li>• If you are using a UNIX or AS/400 host, there is an option for the remote queue name. There is only one valid response to use: PORTLF1.</li> <li>• If Windows does not have LPR installed, the above required option should be left blank.</li> <li>• See the documentation for other operating system specific queue creation.</li> </ul>

Question	Answer
<b>What are the minimum requirements to network a printer?</b>	<ul style="list-style-type: none"><li>• Cat-5 network cable with 10BASE-T connectors</li><li>• PSII</li><li>• Hub or Switch</li><li>• If a hub or switch is NOT used, you need a cross-over cable.</li><li>• Workstation running a TCP stack with print services installed</li></ul>
<b>What do the activity lights on the PSII mean?</b>	<ul style="list-style-type: none"><li>• <b>Fast blinking (9 times/second)</b>—no link status</li><li>• <b>Slow blinking (1 time/second)</b>—no IP address, or the unit is sending data to the parallel port</li><li>• <b>Blinking red</b>—unit is still in POST</li><li>• <b>red-green-red-green</b>—unit is in Netware firmware update mode</li><li>• <b>red-red-green-green</b>—unit is in IP firmware update mode</li><li>• <b>Solid red</b>—unit has failed POST. Remove network cable and restart printer</li></ul>
<b>What is the default User ID and password for the print server?</b>	<ul style="list-style-type: none"><li>• The User ID is <b>admin</b> and the password is <b>1234</b>.</li></ul>

Question	Answer
<p><b>What ports are open on PSII and related software?</b></p>	<p><b>TCP Ports:</b></p> <ul style="list-style-type: none"> <li>• 21 FTP</li> <li>• 23 Telnet</li> <li>• 80 HTTP Server</li> <li>• 515 Printer port</li> <li>• 631 IPP port</li> <li>• 9100 Raw socket connection</li> </ul> <p><b>UDP Ports:</b></p> <ul style="list-style-type: none"> <li>• 161 SNMP broadcast from PSII</li> <li>• 162 SNMP trap on ZebraNet Alert</li> <li>• 4201 discovery destination on PSII</li> <li>• (dynamic) SNMP get request from ZebraNet View</li> <li>• (dynamic) discovery broadcast from ZebraNet view</li> <li>• (dynamic) discovery broadcast from ZebraNet view Java</li> </ul>

---

Question	Answer
<b>What are my network connectivity options based on when using a PSII?</b>	<p>It depends on your environment, but the print server accepts print jobs in any of the following ways:</p> <ul style="list-style-type: none"><li>• <i>FTP</i>—ZPL/EPL files can be sent to the printer via a FTP client as standard ASCII files</li><li>• <i>HTTP</i>—(ZebraLink-enabled printers <i>only</i>) Using the script option of the print server's homepage, you can type ZPL into a specified location of the Web browser and send it to the printer</li><li>• <i>IPP</i>—Using third-party IPP clients, print jobs can be sent via the internet</li><li>• <i>LPR/LPD</i>—Sometimes referred to as queue based printing. LPR/LPD is the standard in network printing. Most TCP/IP operating systems are compatible with this option</li><li>• <i>Raw socket connection</i>—You can connect to the printer directly via the network, bypassing <i>everything in-between</i>. This option is commonly used to integrate ZPL/EPL into existing programs, such as VB scripts</li><li>• <i>POP3</i>—With proper configuration, you can place ZPL/EPL files into the body of an email, and it will print. The print server periodically checks this email box at the specified intervals and prints the body of the message. <b>IMPORTANT:</b> attachments and subject line are not supported</li></ul>

---



# Glossary

**10BASE-T** A type of Ethernet that uses unshielded twisted pair cable.

**arp** The standard TCP/IP method for determining the actual network address of a device based on its IP address.

**ASCII** A standard for the binary representation of characters.

**BOOTP** BOOTP (Bootstrap Protocol) is a protocol that lets a network client configure automatically. It can automatically configure any of the following information: IP address, gateway, subnet, system name, name server, and more. It automatically assigns the necessary settings from a pool of pre-determined addresses for a certain duration of time. BOOTP is the basis for a more advanced network manager protocol, the DHCP (Dynamic Host Configuration Protocol).

**broadcast** In a network, a situation when all destinations on the network receive a given packet.

**client** A workstation or PC in a client/server environment.

**community** For SNMP, a relationship between an agent and a set of SNMP managers that defines security characteristics. The community concept is a local one, defined at the agent. Each community is given a unique community name.

**DHCP (Dynamic Host Configuration Protocol)** DHCP is an alternative to another network IP management protocol, Bootstrap Protocol (BOOTP). Like BOOTP, DHCP can configure an IP address, gateway, subnet, system name, and name server. When speaking about the PSII, BOOTP, and DHCP configure the same options.

**delete bytes** This number is used to remove characters from the beginning of every job sent to the logical printer. The value for delete bytes can range from 0 to 255.

**dynamic** A dynamic configuration, as the name implies, means that it changes. BOOTP and DHCP offer time-based leases for the configurations they assign. Their changes depend on the time-based lease, and how often the printer itself is offline and online again. A dynamic configuration includes BOOTP or DHCP.

**EPL** Eltron Programming Language.

**Ethernet** A widely used local area network system based on the IEEE 802.3 standard.

**firmware** Software routines that are stored in ROM (Read Only Memory). This is typically part of a device, such as a printer or PSII.

**FTP** File Transfer Protocol, a TCP/IP-related protocol for transferring files between devices on a network.

**Flash memory** A type of memory that allows read-and-write operations, but permanently stores data when the power is turned off. Useful for storing firmware because it can be easily updated by downloading new code.

**gateway** A device that converts one higher-level network protocol to a different higher level protocol.

**gleaning** A temporary, local configuration option. Gleaning lets you add the address of the device you want to configure to your local workstation's arp table. This configuration is not permanent and is valid only from the workstation from which you entered the arp information. After the information is entered into the workstation's arp table, the user follows up with a Telnet session to enter the information permanently. This configuration option is used mostly by non-Windows workstations that cannot run the ZebraNet View configuration utility.

**IP** Internet Protocol, one of the main protocols of the TCP/IP protocol suite.

**IP address** A network address used by the TCP/IP protocol.

**IPP** Internet Printing Protocol. Allows you to associate a printer with a URL address that is used for printing over the Internet.

**IPX** Internetwork Packet Exchange, one of the NetWare protocols.

**JetAdmin** A Hewlett-Packard printer management program available for NetWare and TCP/IP.

**logical** Refers to conceptual rather than physical. For example, a computer might have a single physical connection to the network (an Ethernet adapter card), but could have logical connections to several other devices on the network.

**MAC Address** Media Access Control. Ethernet address that corresponds to the assigned IP address.

**name server** A workstation on a TCP/IP network that provides a list of all workstations on the network.

**NetWare** A network operating system developed by Novell.

**node** A device connected to a network, such as a computer or print server.

**parallel port** A port on a device that sends information in groups of bits over multiple wires, one wire for each bit in a group.

**ping** A TCP/IP command that determines whether a device is accessible on the network.

**POP3** Post Office Protocol, the protocol used to retrieve email from the server.

**port** A physical connector, such as the parallel port, or a logical connection to a device.

**post string** A string that is sent at the end of every job going to the logical printer. Maximum 64 characters long.

**pre string** A string that is sent at the beginning of each job that goes to the logical printer. Max 64 characters long.

**print server** A device in a network that changes a network protocol into a printer protocol.

**protocol** A method of sending and receiving data between two or more workstations on a network, and insuring that the data is received without errors.

**rarp** Reverse Arp, a standard TCP/IP method of determining a device's IP address based on its Ethernet address.

**raw TCP port** A type of TCP port in which data is passed unmodified to the receiving node.

**RJ45** A type of modular jack connector similar to a telephone connector with up to eight wires. Used for 10BASE-T Ethernet connections and for serial port connections.

**serial port** On a printer or print server, a port that transfers data one bit at a time. Serial ports usually have either a 25-pin, 9-pin "D", or RJ45 connector.

**server** A device on a local area network that provides services to client computers on the network.

**SMTP** Simple Mail Transfer Protocol, a protocol used to send email messages over the Internet.

**SNMP** Simple Network Management Protocol, a protocol for monitoring and controlling devices on a network.

**spooling** In printing applications, spooling is the transfer of data to a temporary storage area on disk (the print queue) prior to printing. Spooling allows many jobs to be queued to a single printer.

**static** Refers to a static IP address. All information is provided by the network administrator.

**subnet mask** A TCP/IP method of dividing a network into several smaller subnetworks.

**TCP/IP** Transmission Control Protocol/Internet Protocol, the de facto standard for Internet communications that is widely used on local area networks.

**TCP Port** A method of accessing a TCP/IP service, where a device with a single IP address can have multiple TCP ports.

**Telnet** A TCP/IP protocol that allows two devices to communicate over a LAN.

**trap** An unsolicited message sent by an SNMP agent to an SNMP management station. It notifies the management station of some unusual event.

**UNIX** A general-purpose computer operating system used on many different kinds of computers.

**WCSO** Wireless Card Socket Option. Zebra's wireless Ethernet option.

**Windows 95 and Windows 98** Microsofts PC operating systems that feature built-in peer-to-peer networking.

**Windows NT** Microsofts multitasking operating system that can be used either as a client or as a server.

**Windows 2000** Microsofts multitasking operating system that replaces Windows NT; can be used as either as a client or as a server.

**ZebraNet PrintServer II** An Ethernet connectivity solution.

**ZebraLink** Allows you to connect and control your bar code printers anywhere and anytime.

**ZPL II** Zebra Programming Language II is a powerful label-definition and printer-control language.



# Index

## A

- about this document xi
- address
  - configuration label 29
- alerts
  - establishing email messaging 39
  - monitoring with ZebraNet Alert 42
  - setting 36
  - setting in ZebraLink 38
  - setting in ZebraNet View 36
- assigning an IP address 30
  - from printer LCD 33
  - using gleaning
    - how to 35
  - using static route
    - how to 34
  - with DHCP 30
  - without DHCP 30
  - ZebraNet View 30

## B

- before you begin
  - getting started 28
- browser support
  - requirements 5
- BSD-Style
  - print configuration 66

## C

- configuration label 14
  - default gateway 29
  - fields to know 29
  - hardware address 29
  - how to print 28
  - MAC address 29
  - serial number 29
  - subnet mask 29
  - with callouts 14
- configuration lable address 29
- configuration setting
  - browser 45
  - with a browser 45
- configuration settings
  - ZebraNet View 44
- contacts
  - mailing address x
  - Web address x

## D

- default
  - password 76
  - user ID 76
- default factory settings
  - PSII
    - ZebraNet View 58

- default gateway
  - configuration label 29
  - how to set 32
- default PSII factory settings
  - test button 59
  - with WebView 57
- Document Conventions xiii
- document conventions xiii
  - caution xiii
  - command line xiii
  - example xiv
  - hot links xiii
  - illustration callout instruction xiv
  - important xiii
  - note xiii, xiv
  - warning xiii

## **E**

- email messaging
  - alerts 39
- external PSII
  - how to install 12
  - illustration 12
  - installation 12

## **F**

- factory installation 8
- feedback form x
- field installation 8
- File Transfer Protocol 73
- FTP 73

## **G**

- gleaning 35

## **H**

- hardware
  - requirements 5
- how to install

- external PSII 12
- internal PSII 17
- HP JetAdmin
  - troubleshooting 126
- HP Web JetAdmin
  - troubleshooting 126

## **I**

- illustration
  - external PSII 12
  - internal PSII 16
- installation
  - external PSII 12
  - internal PSII 16
  - ZebraNet Utilities 19
  - ZebraNet View Java Applet 23
- installation types 8
  - factory 8
  - field 8
- internal PSII
  - how to install 17
  - illustration 16
  - installation 16
  - tools to install 16
- IP address
  - assigning in telnet session 34
  - how to assign 31
- IP address assigning
  - in a non-Windows environment 33
- IPP
  - support 72
- IPX 51

## **M**

- MAC address
  - configuration label 29

## **N**

- NetWare
  - attach generic text driver 63



NetWare print configuration 61

## O

overview 2  
    illustration 2  
overview illustration  
    explanation 3

## P

parallel port locations  
    illustration 13  
password  
    default 76  
prerequisites  
    System V 68  
print configuration  
    BSD-Style 66  
    System V 68  
print problems  
    troubleshooting 125  
print protocol  
    Internet printing protocol 72  
    IPP 72  
printing  
    configuration label 28  
    PServer mode 62  
protocols  
    how to enable with WebView 53  
    how to enable with ZebraNet View 55  
PServer mode  
    printing 62  
PSII  
    settings 47  
    specifications 9  
PSII settings  
    how to access 76

## R

related documents xv  
requirements

browser support 5  
    hardware 5  
    software 5  
resetting to factory defaults  
    troubleshooting 124

## S

serial number  
    configuration label 29  
setup PSII port  
    Windows 95/98 50  
software  
    requirements 5  
software license agreement ii  
specifications 9  
static route 34  
status indicator  
    troubleshooting 124  
subnet mask  
    configuration label 29  
    how to set 32  
System V  
    prerequisites 68  
    print configuration 68  
    UNIX configuration 68

## T

test button  
    default PSII factory settings 59  
troubleshooting  
    HP JetAdmin 126  
    HP Web JetAdmin 126  
    resetting to factory defaults 124  
    status indicator 124  
    unable to configure device 126  
    unable to print 125  
    ZebraNet View Utility 125

## U

unable to configure device

troubleshooting 126  
user ID  
  default 76

## **W**

warranty i  
  exclusions and conditions ii  
  PSII i  
  software license agreement ii  
WebView  
  default PSII factory settings 57  
  directory listing 99  
  home page 90  
  how to enable protocols 53  
  printer configuration 91  
  view and modify printer settings 93  
Windows 95/98  
  setup PSII port 50

## **Z**

ZebraLink  
  setting alerts 38  
ZebraNet Alerts  
  monitoring alerts 42  
ZebraNet Connect IP 49  
  Windows NT 4.0 / Windows 2000 49  
ZebraNet Utilities  
  how to install 19  
  installation 19  
ZebraNet View  
  configuration settings 44  
  how to enable protocols 55  
  PSII  
    default factory settings 58  
    setting alerts 36  
ZebraNet View Java Applet  
  how to install 23  
  installation 23





**Zebra Technologies**

333 Corporate Woods Parkway  
Vernon Hills, Illinois 60061.3109 U. S. A.  
Telephone +1 847.634.6700  
Facsimile +1 847.913.8766

**Zebra Technologies Europe Limited**

Zebra House  
The Valley Centre, Gordon Road  
High Wycombe  
Buckinghamshire HP13 6EQ, UK  
Telephone +44 (0) 1494 472872  
Facsimile +44 (0) 1494 450103

