

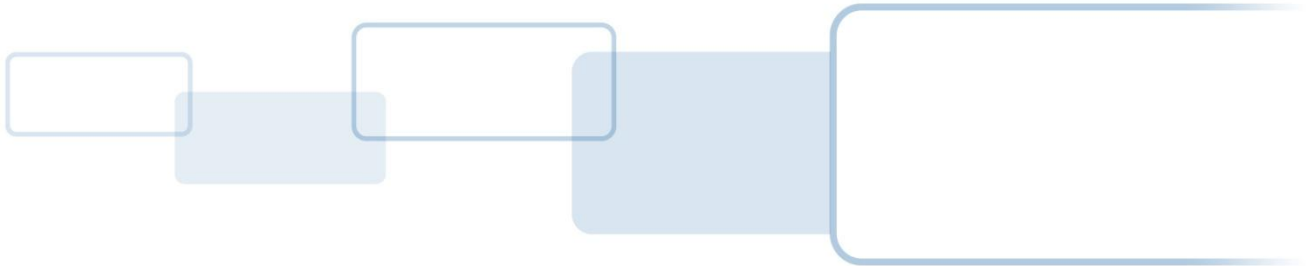

15370 Barranca Parkway
Irvine, CA 92618



HDP5000 (2008 & 2013) Card Printer

SPARE PART LIST

S000565 rev 4.4

April 2014

© 2014 HID Global Corporation/ASSA ABLOY AB. All rights reserved.

All rights reserved. This document may not be reproduced, disseminated or republished in any form without the prior written permission of HID Global Corporation.

Copyright

© 2014 HID Global Corporation/ASSA ABLOY AB. All rights reserved.

Trademarks

HID GLOBAL, HID, the HID logo, FARGO and HDP are the trademarks or registered trademarks of HID Global Corporation, or its licensors, in the U.S. and other countries.

Revision Control Number	Date	Document Title
Revision 4.4	April 2014	HDP5000 High Definition Card Printer/Encoder - Spare Parts List. Removed 2008 Cover Part number. Use 2013 cover part numbers EXCEPT THE FRONT BEZEL COVER USE D910283-01 FOR 2008 PRINTER AND D910702-01 FOR 2013 PRINTER
Revision 4.3	February 2014	HDP5000 High Definition Card Printer/Encoder - Spare Parts List. Added label part numbers
Revision 4.2	January 2014	HDP5000 High Definition Card Printer/Encoder - Spare Parts List. Update price for D910021-01
Revision 4.1	January 2014	HDP5000 High Definition Card Printer/Encoder - Spare Parts List. Removed D910054, now use D910704 for both the 2008 & 2013 HDP5000 Printer. Added picture of new FILM Cartridge
Revision 4.0	November 2013	HDP5000 High Definition Card Printer/Encoder - Spare Parts List. Replaced D910206 PH Power/Control Cable with EDP-00067
Revision 3.9	October 2013	HDP5000 High Definition Card Printer/Encoder - Spare Parts List. Clarified specific part numbers for HDP (2013) printer.
Revision 3.8	May 2013	HDP5000 High Definition Card Printer/Encoder - Spare Parts List. Added APPENDIX A NEW HDP5000 (2013) specific parts include: covers, motors, LCD
Revision 3.7	March 2013	HDP5000 High Definition Card Printer/Encoder - Spare Parts List. Replaced D910020-01 with D910536-01
Revision 3.6	October 2012	HDP5000 High Definition Card Printer/Encoder - Spare Parts List. Replaced A000441 with A910551

Contact Information

North America	Europe, Middle East and Africa
15370 Barranca Parkway Irvine, CA 92618 USA Phone: 800 237 7769 Fax: 949 732 2120 Tech Support: 866 607 7339, #6, M-F 7am-6pm CST	Phoenix Road Haverhill, Suffolk CB9 7AE England Phone: +44 1440 714 850 Fax: +44 1440 714 840 Tech Support: +44 1440 711 822 M-F 9am – 5pm GMT
Asia Pacific	Brazil
19/F 625 King’s Road North Point, Island East Hong Kong Phone: 852 3160 9800 Fax: 852 3160 4809 Tech Support 852 3160 4895 M-F 9am – 6pm GMT +8	Av Guido Caloi 1985 Prédio 18 São Paulo – SP CEP : 05802-140 Phone: 55 11 5514-7100 Fax: 55 11 5514-7109 Tech Support: 55 11 5514-7110 M-F 9am – 6pm ATC

support.hidglobal.com

***** Refer to Appendix A for specific HDP5000 (2013) Card Printer Spare Parts.**

NEW HDP5000 (2013) Card Printer part numbers 0896xx to 0899xx, with serial number cut-in B3080651.

Note: The parts noted in the APPENDIX A are not backwards compatible with HDP5000 (2008) Card Printer part number 0890XX. (Unless otherwise stated)

Covers are compatible for both 2008 & 2013 Card Printers





EXCEPT THE FRONT BEZEL COVER USE D910283-01 FOR 2008 PRINTER AND D910702-01 FOR 2013 PRINTER

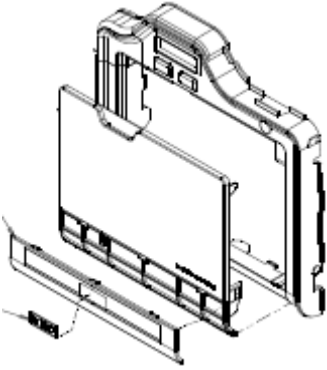

HDP5000 High Definition Card Printer/Encoder

PRINTER

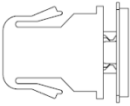
Recommended Spare Parts List

Effective Date: April 2014

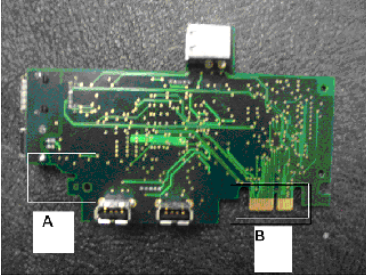
Name (Part Number)	Price	Photo
<p>Front Panel Trim Cover (D910283-01)</p> <p>(contains Front door cover, LCD board, HID Badge, and cable)</p> <p>If you need just the LCD board, you must purchase the complete Front Panel Trim Cover.</p> <p>Compatible for 2008 Printer ONLY</p>	\$216.50	 <p>Does not contain the ribbon & film label (L000825)</p>
<p>Ribbon & Film Loading label (L000825)</p>	\$4.50	 <p>Placed inside front door cover for 2008 & 2013</p>
<p>Touch Latch- front door cover (F000331)</p>	\$20.60	 <p>(2008)</p>
<p>HDP Badge- front door cover (L001000)</p>	\$3.60	 <p>(2008)</p>

<p>USB/Ethernet Board Assembly (A910551)</p>	<p>\$275.00</p>	 <p>This replaces (A000441)</p>
<p>RFID Board Assembly Used for Ribbon and Film Motors (A000365)</p>	<p>\$7.75</p>	

HDP5000 High Definition Card Printer/Encoder
PRINTER
Recommended Spare Parts List
Effective Date: April 2014

Magnetic Head/Board (089201- Module kit)	\$599.00	
Complete Cable Bundle (D910030)	\$250.00	(2008)
Printhead Power & Control Cable JP2 (EDP-00067)	\$45.00	
Ribbon Take-Up Motor Sensor (D910218)	\$27.10	
Film Supply Motor Sensor (D910218)	\$27.10	
Card Path Sensor, Motor, Fan Cable JP1 (D910200)	\$43.00	(2008)

HDP5000 High Definition Card Printer/Encoder
PRINTER
Recommended Spare Parts List
Effective Date: April 2014

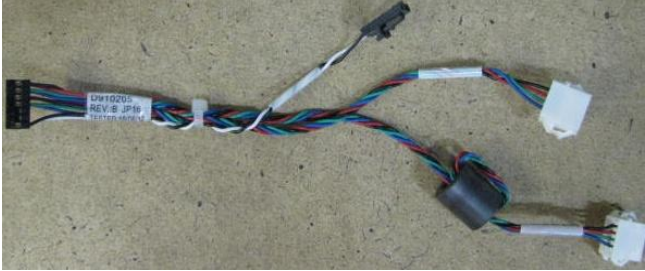
Fan & Motor Cable JP 5 (D910201) this cable is used for all motors	\$26.00	(2008)
Ribbon & Film Sensor Cable JP 7 (D910202)	\$21.00	
Color Ribbon Sensor Cable (lower LED) JP 11 (086187 kit part number contains D910556 plus instruction)	\$10.00	
Lam Sensor Cable (printer) JP16 (D910205)	\$17.00	

HDP5000 High Definition Card Printer/Encoder
PRINTER
Recommended Spare Parts List
Effective Date: April 2014

Magnetic Encoder Cable JP3 (D910207)	\$15.00	
RFID Ribbon/Film Board Cable JP 13 (D910209)	\$6.50	
Lam up/down Sensor (Printer Headlift sensor) (D910216)	\$32.00	
Card Sensor with Cable (D910217)	\$28.00	
Card Roller/ Gear (D910064)	\$52.00	
Card Roller (D910107)	\$42.00	

HDP5000 High Definition Card Printer/Encoder
PRINTER
Recommended Spare Parts List
Effective Date: April 2014

Card Roller (D910062) Card Path Output Roller	\$20.00	
Card Roller (D910455)	\$22.00	
Card Roller (D910065)	\$41.60	
Platen Card Roller (D910101) (in Card Path)	\$60.00	
Printer Platen Roller (D910109)	\$58.00	
Drive Train Stepper Motor- Card Path (D910073)	\$87.00	 <p>(2008)</p>



HDP5000 High Definition Card Printer/Encoder
PRINTER
Recommended Spare Parts List
Effective Date: April 2014

Printer Platen Roller (D910109)	\$58.00	
Drive Train Stepper Motor- Card Path (D910073)	\$87.00	 (2008)
Card Feed Motor (D910074)	\$87.00	
Film Supply Motor (D910055) yellow tip	\$75.00	 (2008)
Ribbon Supply Motor (D910057) orange tip	\$60.00	 (2008)

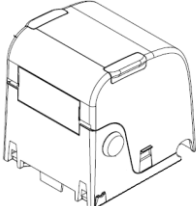

HDP5000 High Definition Card Printer/Encoder
PRINTER
Recommended Spare Parts List
Effective Date: April 2014

Film Take-Up Motor (D910058) green tip	\$60.00	 (2008)
Ribbon Take-Up Motor (D910056) blue tip	\$75.00	 (2008)
Head Lift Motor Complete Assembly contains the bracket- No sensor. (D910052)	\$70.00	
Print Stepper Motor (D910050) Complete Assembly contains belts (F000093) and pulley	\$70.00	 (2008)
Print Stepper Motor Belts- 2 used (F000093)	\$5.27	

HDP5000 High Definition Card Printer/Encoder
PRINTER
Recommended Spare Parts List
Effective Date: April 2014

Printhead Replacement KIT (086091)	\$699.00	
Fan with Cable (D910212)	\$24.00	
Card Cartridge (D910536-01) <ul style="list-style-type: none"> This new part is backwards compatible 	\$110.00	
Ribbon Cartridge (D910022)	\$95.00	
Film Cartridge (D910023)	\$95.00	 <p>See note on D910704</p>

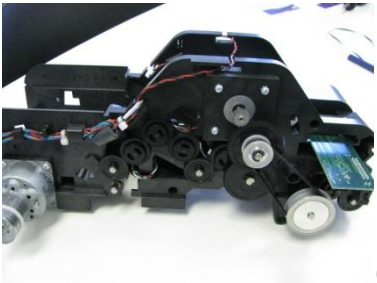
HDP5000 High Definition Card Printer/Encoder
PRINTER
Recommended Spare Parts List
Effective Date: April 2014

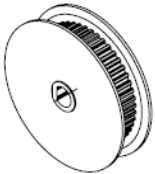
Output Bin (D910021-01)	\$86.00	
Cleaning Roller- black inner roller support (D855170)	\$6.50	
Power Supply E000480	\$140.00	
Key and Lock set (089213)	\$100.00	
Complete Card Path Assembly (D910006)	\$760.00	 (2008)
Combo-Pulley/spur gears (D910452)	\$36.00	
Card Path Pulley (D910485)	\$52.06	

HDP5000 High Definition Card Printer/Encoder
PRINTER
Recommended Spare Parts List
Effective Date: April 2014

Belt (F000492)	\$5.00	
Card Idler Roller (D810040)	\$18.00	
Input Idler Roller (D910121)	\$2.75	
Gear 72x56 tooth (D910112)	\$1.60	
Main Plastic Gear (D910110) 5 used	\$1.80	

HDP5000 High Definition Card Printer/Encoder**PRINTER****Recommended Spare Parts List**





Effective Date: April 2014

TRANSFER ARM ASSEMBLY D910704

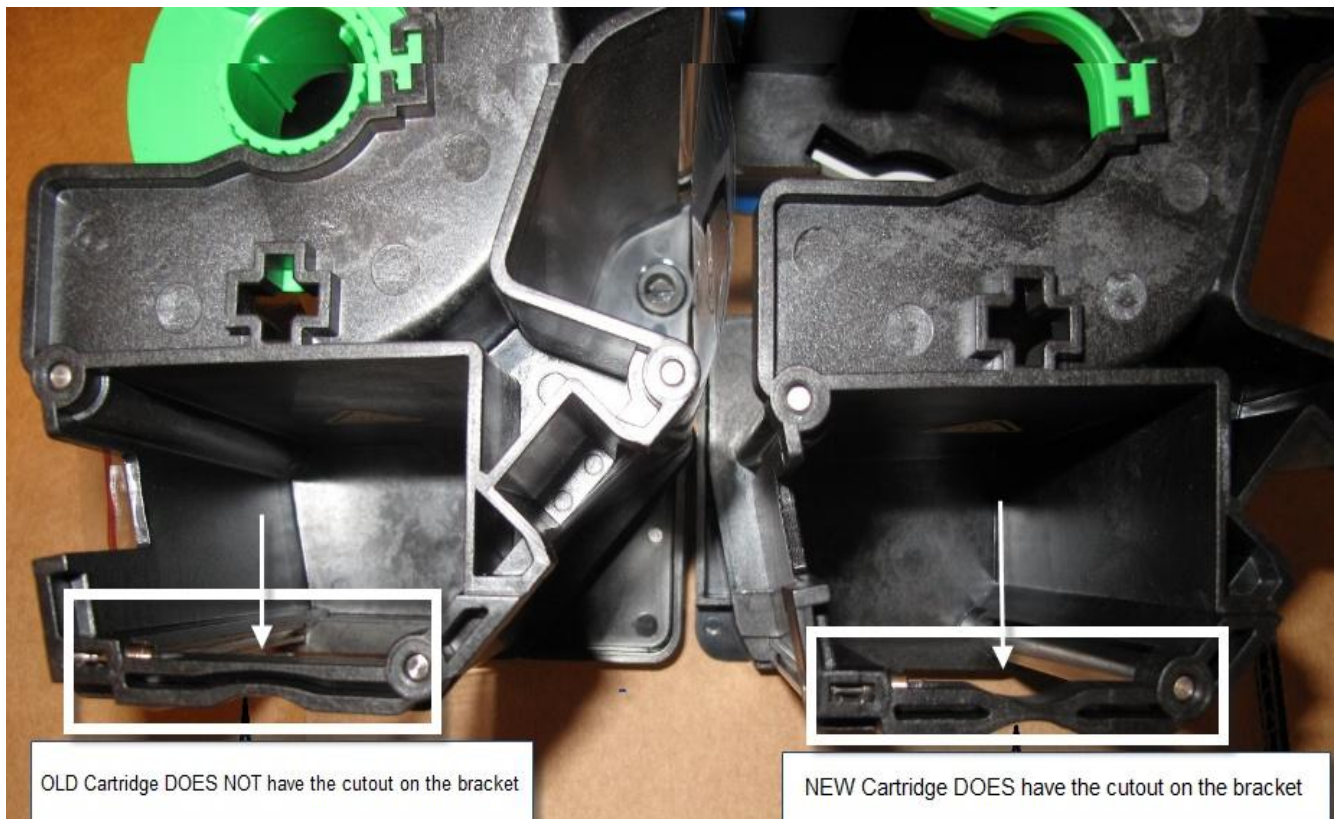

IS backwards compatible for both the HDP5000 (2008) & HDP5000 (2013)

***NOTE: When replacing the transfer arm in either the 2008 or 2013 HDP5000 Printer, check the FILM Cartridge. The picture below compares the old and new cartridge. If your film cartridge does NOT have the cutout as shown below then please order a new cartridge kit (089214).**

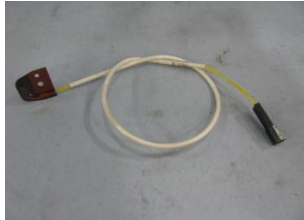

Only the parts below may be ordered separately from the complete assembly		
Complete Assembly (D910704)	\$535.00	
Lift Sensor for Transfer Arm (D910216)	\$32.00	
Motor (D910072)	\$55.00	
Roller (D880146)	\$122.00	 The heater bearing- 2 used- (D860268_ \$9.56) may be re-used if not damaged.
Heater Core D910172	\$92.00	
RTD Kapton EDP-00043	\$97.00	



HDP5000 High Definition Card Printer/Encoder
FLIPPER MODULE
Recommended Spare Parts List
Effective Date: April 2014

MAINBOARD (A000394)	\$155.80	
Connection Board from Flipper to Printer (D000446)	\$29.00	
Communication/Access ory Board (A000451)	\$77.75	
Flipper Sensor Cable (D900249)	\$76.25	
Motor Cable (D900251)	\$3.75	

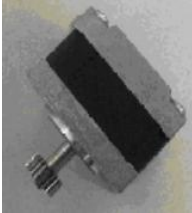

HDP5000 High Definition Card Printer/Encoder
FLIPPER MODULE
Recommended Spare Parts List
Effective Date: April 2014

Idler Pulley 2 used (D900241)	\$1.45	
Main Pulley (D850190)	\$1.50	
Pulley (D900287)	\$1.25	
Card Transport drive Gear (810266)	\$.91	
Gear (D860280)	\$3.50	
Belt (220082)	\$9.23	
Stepper Motor-Card Drive (D900523)	\$52.00	

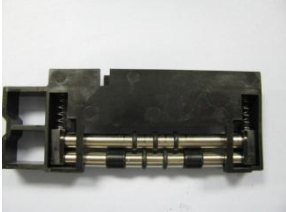
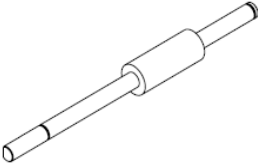
HDP5000 High Definition Card Printer/Encoder
FLIPPER MODULE
Recommended Spare Parts List
Effective Date: April 2014

Stepper Motor-Flipper Motor (D900524)	\$42.00	
Flipper Table Full Assembly (D900205)	\$113.00	
Output Roller Assembly (D910404)	\$37.50	
Flipper Output Roller (D900123)	\$35.75	

HDP5000 High Definition Card Printer/Encoder
LAMINATION MODULE
Recommended Spare Parts List
Effective Date: April 2014

Set of 3 labels for inside front lam door (L000960) (2008 & 2013)	\$3.61	
Lam Cartridge- TOP (D920134)	\$39.00	
Lam Cartridge- BOTTOM (D920135)	\$39.00	
Film Sensor- Upper (D920343) 2 used in Dual Laminators	\$7.75	 connects J27
Film Sensor- Lower (D920343) 1 used in Single and Dual Laminators	\$7.75	 connects J26

HDP5000 High Definition Card Printer/Encoder
LAMINATION MODULE
Recommended Spare Parts List
Effective Date: April 2014

Card Input Sensor (A000462)	\$14.60	
RFID Board –Single Lamination Module Used in TOP REWIND MOTOR (A000365-01) mounted to printer BODY Cable connects to J19	\$8.00	
RFID Board –Dual Lamination Module Used in BOTTOM REWIND MOTOR (A000365-01) mounted to printer FRONT COVER Cable connects to J20	\$8.00	
Main Board- Laminator (A920221-16 Single) (A920221-17 Dual)	\$475.00	



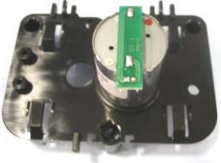

DP5000 High Definition Card Printer/Encoder
LAMINATION MODULE
Recommended Spare Parts List
Effective Date: April 2014

Stepper Motor (D920030) Uses Belt F000428	\$52.00	
Stepper Motor Belt (F000428)	\$15.00	
Take-Up Motor (D920189) Single Lamination Module uses 1 Motor Dual Lamination Module uses 2 Motors Cable Same for both (D920153)	\$70.00 \$6.30	
Rewind Motor (D900406) Single Lamination Module uses 1 Motor Dual Lamination Module uses 2 Motors Cable (D920153)	\$30.00 \$6.30	

DP5000 High Definition Card Printer/Encoder
LAMINATION MODULE
Recommended Spare Parts List
Effective Date: April 2014

<p>Lamination Head Assembly-Bottom (D920023)</p> <p>1 used in Dual and Single Lamination Module</p> <p>This part is sold as one assembly which includes the Film LED (A000454) Head Lift Sensor (A000126) Thermocouple RTD (A000449) Motor (D900484-05) and the wires.</p>	<p>\$352.00</p>	
<p>Lamination Head Assembly- TOP (D920022)</p> <p>1 used in Dual Lamination Module</p> <p>This part is sold as one assembly which includes the Film LED (A000454) Head Lift Sensor (A000126) Thermocouple RTD (A000449) Motor D910484-05 and the wires.</p>	<p>\$352.00</p>	
<p>Card Transport Drive Gear (810266)</p> <p>2 used</p>	<p>\$.91</p>	

HDP5000 High Definition Card Printer/Encoder
LAMINATION MODULE
Recommended Spare Parts List
Effective Date: April 2014

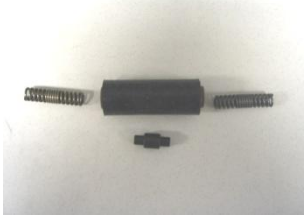
Main Pulley (D850190) 4 used	\$1.50	
Card Transport Drive Belt (220082) 2 used	\$9.23	
Gear- 72 X 36 TOOTH MOLDED (D860280)	\$3.50	
PULLEY 28G (D841202)	\$4.36	
Pinch Roller (D920013) 5 used total	\$4.40	
Pinch Roller Output (D920018)	\$11.20	

HDP5000 High Definition Card Printer/Encoder
LAMINATION MODULE
Recommended Spare Parts List
Effective Date: April 2014

Roller- Feed (D920119) 1 used	\$14.80	A black cylindrical roller mounted on a metal shaft with a small black cap on the right end.
Roller- Feed-High Cof (D920119-01) 2 used	\$22.60	A black cylindrical roller mounted on a metal shaft with a small black cap on the right end.
Input Roller (D920015)	\$15.60	A black cylindrical roller mounted on a metal shaft with a small black cap on the right end.

APPENDIX A HDP5000 (2013)

Note: Some of these parts are not backwards compatible with HDP5000 Printer part number 0890XX. (Unless specifically called out)

Verify the Printer part number to ensure you order the correct part replacement.

NEW HDP5000 (2013) Printer part numbers 0896xx to 0899xx, with serial number cut-in B3080651.

COVERS ARE COMPATIBLE FOR BOTH 2008 & 2013 Card Printers

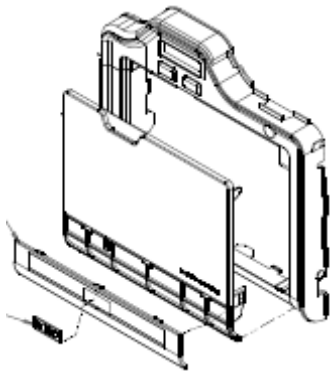

EXCEPT THE FRONT BEZEL COVER USE D910283-01 FOR 2008 PRINTER AND D910702-01 FOR 2013 PRINTER

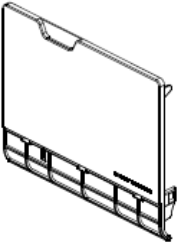
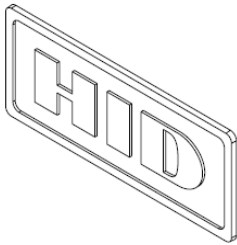
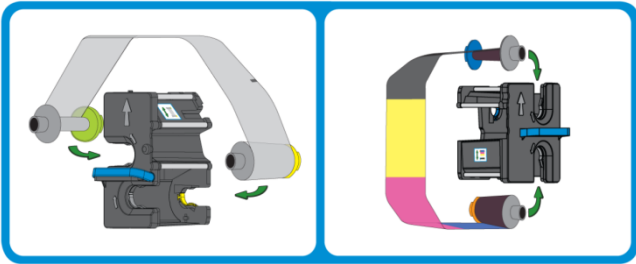

HDP5000 (2013) High Definition Card Printer/Encoder
PRINTER
Recommended Spare Parts List
Effective Date: April 2014

Name (Part Number)	Price	Photo
Front Door- only (D910811-01) Compatible for 2008 & 2013	\$11.65	 <p>does not contain Door Accent (D910816-01) or HID Badge (L001393) or ribbon/film loading label (L000825)</p>
HID Badge L001393	\$6.00	 <p>Front Door Cover</p>
Ribbon & Film Loading Label L000825	\$4.50	

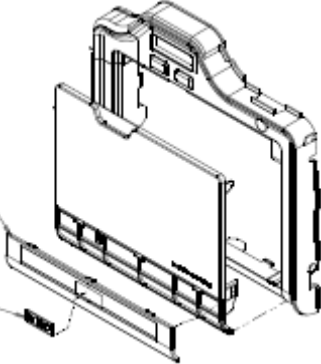
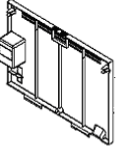
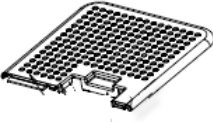
HDP5000 (2013) High Definition Card Printer/Encoder
PRINTER
Recommended Spare Parts List
Effective Date: April 2014

Front Door accent (D910816-01) Compatible for 2008 & 2013	\$8.00	 Does not contain HID Badge (L001393)
Front Panel Trim Cover (D910702-01) (contains Front door cover, LCD board, HID Badge, and cable) If you need just the LCD board, you must purchase the complete Front Panel Trim Cover. Compatible for 2013 Printer ONLY	\$216.50	 Does not contain the ribbon & film label (L000825)
Back Cover (D910821-01) Compatible for 2008 & 2013	\$15.20	
Input Side Cover (D910822-01) Compatible for 2008 & 2013	\$23.50	
Upgrade Cover (D910828-01) Compatible for 2008 & 2013	\$4.25	

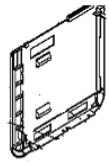
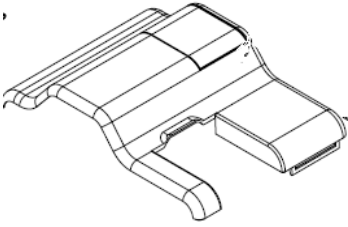
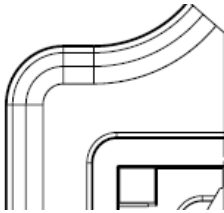
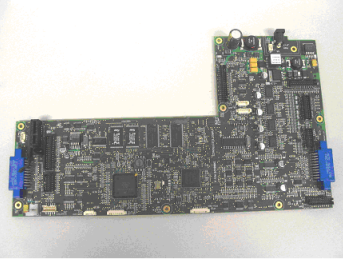

HDP5000 (2013) High Definition Card Printer/Encoder
PRINTER
Recommended Spare Parts List
Effective Date: April 2014

Output Side Cover (D910823-01) Compatible for 2008 & 2013	\$17.00	
Top Cover (D910706-01) Compatible for 2008 & 2013	\$27.00	
Magnetic Cover Insert D910827-01 Compatible for 2008 & 2013	\$13.00	
Main Board –Printer (PCA-00013) Serial Number cut in for new main board B3080651	\$900.00	 <p>The main board is NOT backwards compatible so checking the Printer serial number cut in (B3080651) is essential in getting the correct replacement.</p>

HDP5000 (2013) High Definition Card Printer/Encoder
PRINTER
Recommended Spare Parts List
Effective Date: April 2014

Complete Cable Bundle (D910744)	\$174.00	
Card Path Sensor, Motor, Fan Cable (D910742)	\$21.00	Connects to JP1
Fan & Motor Cable (D910741)	\$26.00	Connects to JP5 this cable is used for all motors
Drive Train Stepper Motor- Card Path (D910729)	\$49.00	
Print Stepper Motor (D910727) Complete Assembly contains 2 belts (F000093) and pulley D840888	\$70.00	
Film Supply Motor (D910723) yellow tip	\$75.00	

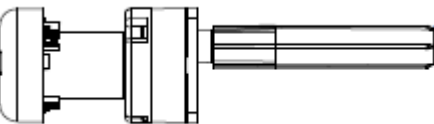
HDP5000 (2013) High Definition Card Printer/Encoder
PRINTER
Recommended Spare Parts List
Effective Date: April 2014

Ribbon Supply Motor (D910725) orange tip	\$60.00	
Film Take-Up Motor (D910726) green tip	\$60.00	
Ribbon Take-Up Motor (D910724) blue tip	\$75.00	
Complete Card Path Assembly (D910721)	\$760.00	
Pinch Roller (D900098)	\$5.50	On Card Path
Pinch Roller Spring (F000338)	\$1.75	On Card Path

HDP5000 (2013) High Definition Card Printer/Encoder
FLIPPER MODULE
Recommended Spare Parts List
Effective Date: April 2014

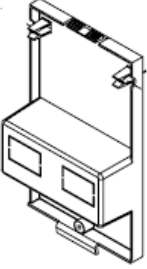
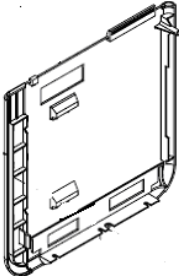
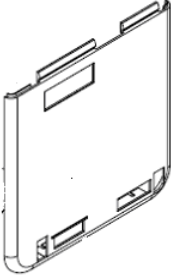
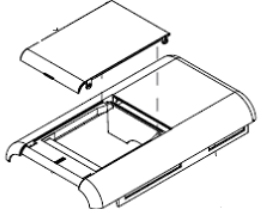
Flipper Back Access Cover (D910847-01) Compatible for 2008 & 2013	\$20.00	
Output Side Cover (D910823-01) Compatible for 2008 & 2013	\$17.00	
Input Side Cover (D910846-01) Compatible for 2008 & 2013	\$13.10	
Top Cover- Flipper (D910848-01) no lid D910849-01 Top Lid Parts sold separately	\$17.00 \$8.00	 Compatible for 2008 & 2013

HDP5000 (2013) High Definition Card Printer/Encoder
FLIPPER MODULE
Recommended Spare Parts List
Effective Date: April 2014

Front Cover- Flipper (D910845-01) Compatible for 2008 & 2013	\$15.00	
Back Access Assembly- Lam Module (D910821-01) Compatible for 2008 & 2013	\$15.20	
Upgrade Cover (D910828-01) Compatible for 2008 & 2013	\$4.25	

HDP5000 (2013) High Definition Card Printer/Encoder
LAMINATION MODULE
Recommended Spare Parts List
Effective Date: April 2014

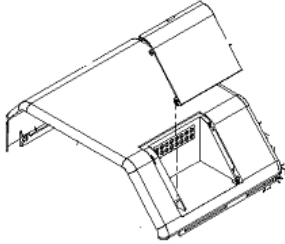
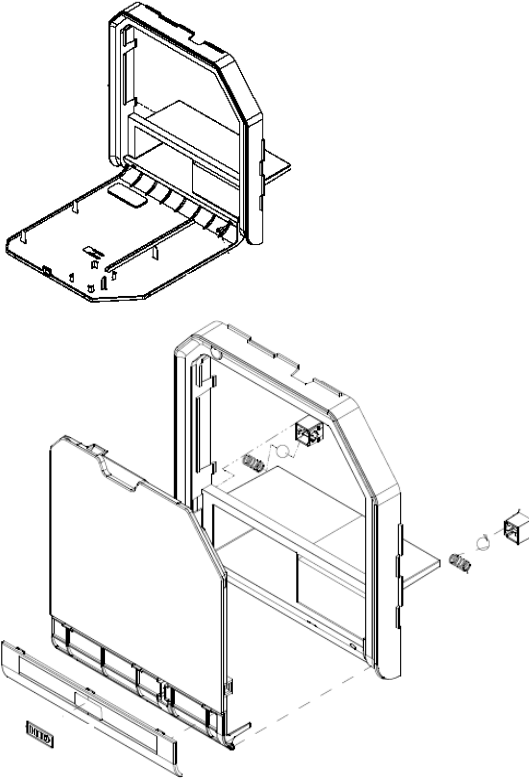
Part Name (Part Number)	Price	Photo
Top Cover (D920337-01) Compatible for 2008 & 2013	\$28.35	
Front Door (D920341-01) Complete Front door only D920229-01 Bottom front door accent only D920230-01 Steel Ball F000503 Spring F000504 HID Badge for front door accent L001393 Compatible for 2008 & 2013	\$32.00 \$12.00 .50 .50 \$6.00	

HDP5000 (2013) High Definition Card Printer/Encoder

LAMINATION MODULE
Recommended Spare Parts List
Effective Date: April 2014

<p>Set of 3 labels for inside front lam door (L000960)</p>	<p>\$3.61</p>	<p>The diagram illustrates the installation of labels in the lamination module. It includes three main sections:</p> <ul style="list-style-type: none"> Top Left: Shows a label being placed on a card. A yellow '2' indicates the label's position. A circular inset shows a close-up of the label's edge with a radius of $R\ 0.064''$. Top Right: Shows the lamination module with two labels (1 and 2) installed. A circular inset shows a close-up of the label's edge with a radius of $R\ 0.167''$. Bottom Right: Shows a close-up of the lamination module with two labels (1 and 2) installed. A circular inset shows a close-up of the label's edge with a radius of $R\ 0.138''$. A note below this inset reads: "FARGO RECOMMENDS USING FARGO ULTRACARD™ OR SIMILAR COMPOSITE CARDS IN THE LAMINATION MODULE."
--	---------------	---

HDP5000 (2013) High Definition Card Printer/Encoder
DUAL INPUT HOPPER
Recommended Spare Parts List
Effective Date: April 2014
Dual Input Hopper

Headlift Sensor/Cable (D900113)	\$25.48	Located on Hopper Card Path 
Pinch Roller (D900098)	\$6.63	Located on Hopper Card Path
PCB Interface (A910818)	\$32.00	PCB connects Hopper to Printer
Input Ribbon Cable (D910864)	\$20.00	
Dual Input Hopper upgrade kit (089270)	\$899.00	No Lock