



BC-80X0

CRADLE

QUICK REFERENCE GUIDE



Datalogic Scanning, Inc.
959 Terry Street
Eugene, Oregon 97402
USA
Telephone: (541) 683-5700
Fax: (541) 345-7140

An Unpublished Work - All rights reserved. No part of the contents of this documentation or the procedures described therein may be reproduced or transmitted in any form or by any means without prior written permission of Datalogic Scanning, Inc. or its subsidiaries or affiliates ("Datalogic" or "Datalogic Scanning"). Owners of Datalogic products are hereby granted a non-exclusive, revocable license to reproduce and transmit this documentation for the purchaser's own internal business purposes. Purchaser shall not remove or alter any proprietary notices, including copyright notices, contained in this documentation and shall ensure that all notices appear on any reproductions of the documentation.

Should future revisions of this manual be published, you can acquire printed versions by contacting your Datalogic representative. Electronic versions may either be downloadable from the Datalogic website (www.scanning.datalogic.com) or provided on appropriate media. If you visit our website and would like to make comments or suggestions about this or other Datalogic publications, please let us know via the "Contact Datalogic" page.

DISCLAIMER

Datalogic has taken reasonable measures to provide information in this manual that is complete and accurate, however, Datalogic reserves the right to change any specification at any time without prior notice. Datalogic is a registered trademark of Datalogic S.p.A. in many countries and the Datalogic logo is a trademark of Datalogic S.p.A. all licensed to Datalogic Scanning, Inc. All other trademarks and trade names referred to herein are property of their respective owners.

UPDATES AND LANGUAGE AVAILABILITY

UK/US

The latest drivers and documentation updates for this product are available on Internet.
Log on to: www.scanning.datalogic.com

I

Su Internet sono disponibili le versioni aggiornate di driver e documentazione di questo prodotto. Questo manuale è disponibile anche nella versione italiana.
Collegarsi a: www.scanning.datalogic.com

F

Les versions mises à jour de drivers et documentation de ce produit sont disponibles sur Internet. Ce manuel est aussi disponible en version française.
Cliquez sur : www.scanning.datalogic.com

D

Im Internet finden Sie die aktuellsten Versionen der Treiber und Dokumentation für dieses Produkt. Die deutschsprachige Version dieses Handbuchs ist auch verfügbar.
Adresse : www.scanning.datalogic.com

E

En Internet están disponibles las versiones actualizadas de los drivers y documentación de este producto. También está disponible la versión en español de este manual.
Dirección Internet : www.scanning.datalogic.com

USING BC-80X0 RADIO CRADLE

The BC-80X0 cradle, paired with one or more PowerScan® M8300 readers, builds a Cordless Reading System for the collection, decoding and transmission of barcoded data.

It can be connected to a Host PC through an RS-232, USB, Wedge or Pen cable and is suited for single-cradle point-to-point layouts. It can also be connected to a C-BOX and therefore integrated into a fixed scanner application.

The BC-8060 models also allow multi-cradle layouts through an RS-485 Network. For this network connection refer to the PowerScan® D8330/M8300 Reference Manual.

The label on the cradle contains LED indicators and a scan finder button. When the button is pressed, the cradle transmits a “broadcast” message. All properly configured scanners (Radio RX Timeout set to keep the radio “awake”) that are linked to that base (through a bind or a join sequence) and within radio range coverage will emit a beep sequence once every 2 seconds for 30 seconds. This functionality is useful to:

- verify which scanners are linked to a certain base station
- detect a scanner forgotten somewhere

The LEDs signal the BC-80X0 status, as described in the following table:

LED	STATUS
Aux	Yellow On = BC-80X0 is powered through an external power supply. Yellow Blinking = BC-80X0 transmission occurs over the Host port.
Host	Yellow On = BC-80X0 is powered by the Host. Yellow Blinking = BC-80X0 transmission occurs over the Host port.
Reader	Green On = the reader battery is completely charged. Red On = the reader battery is charging. Orange Blinking = reader battery fault – replace battery. Red / Green Alternatively Blinking = charging error - see Ref. Manual
Spare*	Green On = the spare battery is completely charged. Red On = the spare battery is charging. Orange Blinking = spare battery fault – replace battery. Red / Green Alternatively Blinking = charging error - see Ref. Manual

* This LED refers to the accessory SBS-8000 Spare Battery Slot when mounted to the BC-8060. Not available for BC-8010 models.



Figure 1 – Cradle Overview



Figure 2 – LEDs

To setup your BC-80X0 cradle you must:

1. Physically install the cradle.
2. Make all system connections.
3. Configure the BC-80X0 cradle.

INSTALLATION

MOUNTING THE BC-80X0 CRADLE

The cradle package contains the following items:

BC-80X0	1 horizontal base
BC-80X0 Quick Reference Guide	2 wall-mounting lock hinges
BC-8000 Antenna	4 rubber feet
2 adhesive strips	1 inclined base

The cradle can be mounted for portable or fixed desktop usage, or it can be fixed to a wall. The horizontal base allows portable and fixed desktop usage, while the inclined base provides desktop and wall mounting guaranteeing a comfortable handling of the PowerScan® M8300 reader.



BC-80X0 Cradle mounted on the Horizontal Base



BC-80X0 Cradle mounted on the Inclined Base

Desktop mounting

For desktop usage, you can mount the cradle either on the horizontal base, for reduced overall dimensions, or on the inclined base for a more ergonomic taking out and insertion of the reader onto the cradle.

Horizontal base

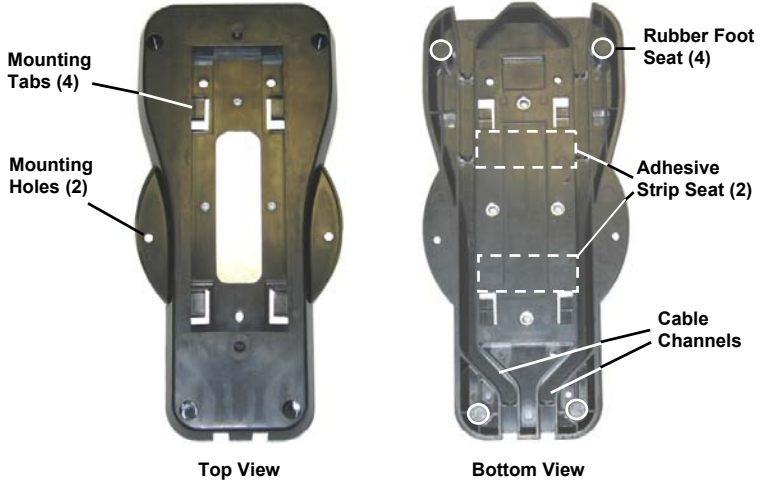

Inclined base

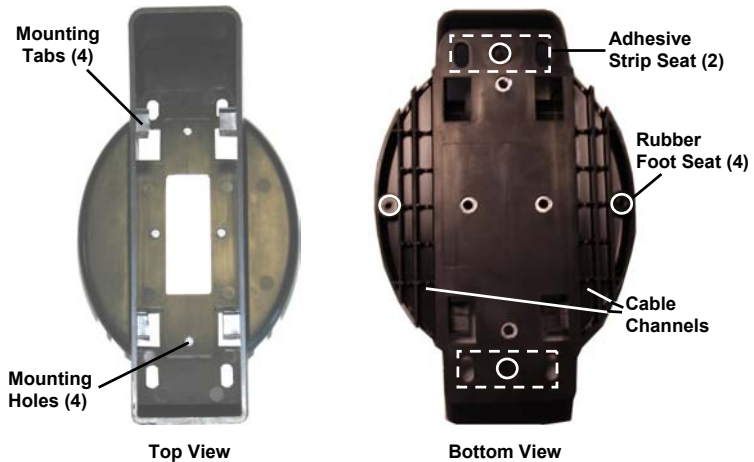

PORTABLE DESKTOP USE

1. Correctly position the BC-80X0 onto the base by sliding it along the mounting tabs until aligned.

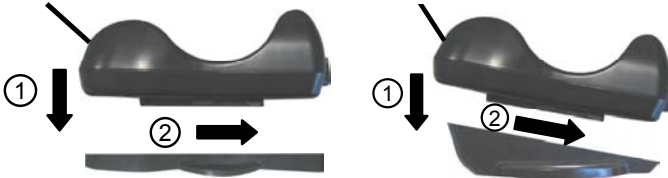

2. Carefully clean the rubber foot seats of the base to remove any impurities that could reduce adhesion.
3. Remove the protective plastic from the rubber feet and stick them onto the bottom surface of the base.
4. If mounting the BC-80X0 cradle, insert the antenna in the appropriate hole on the body of the cradle and screw it clockwise until tight.

FIXED DESKTOP USE

For fixed desktop installation, use the adhesive strips or fixing screws (not provided) according to your needs.

For mounting with adhesive strips:

1. Position the cradle onto the base by sliding it along the mounting tabs until aligned.
2. Carefully clean the adhesive strip seats of the base to remove any impurities that could reduce adhesion.
3. Remove the protective plastic from one side of the adhesive strips and stick them onto the base surface.
4. Position the cables to be connected to the BC-80X0 cradle along the dedicated channels, as shown in the figures below:



Horizontal Base



Inclined Base

5. Remove the plastic from the other side of the strips and affix the base to the table.
6. If mounting the BC-80X0 cradle, insert the antenna in the appropriate hole on the body of the cradle and screw it clockwise until tight.

For mounting with screws:

1. Position the cables to be connected to the BC-80X0 cradle along the dedicated channels, as shown in the figures below:
2. Position the base on the table and affix it by means of the screws (not provided).
3. Position the cradle on the base by sliding it along the mounting tabs until aligned.
4. If mounting the BC-80X0 cradle, insert the antenna in the appropriate hole on the body of the cradle and screw it clockwise until tight.

Wall Mounting

1. Remove the yellow caps and insert the two wall mounting lock hinges provided with your cradle.



2. Position the cables to be connected to the BC-80X0 cradle along the dedicated channels (see figures at page 4).

If using the **adhesive strips**:

3. Carefully clean the adhesive strip seats of the base to remove any impurities that could reduce adhesion.
4. Remove the protective plastic from one side of the adhesive strips and stick them onto the base surface.
5. Remove the plastic from the other side of the strips and affix the base to the wall as indicated in the figure below.

If using the **mounting screws**:

3. Using the mounting holes on the base as a pattern, mark the wall where you desire to mount the BC-80X0.
4. Drill the appropriate size holes and insert the threaded dowels (not provided) into the holes.
5. Position the base on the wall as indicated in the figure below and affix it by means of the screws (not provided).



Inclined Base Wall-mounting

6. Attach the cradle on the base by sliding it along the mounting tabs until aligned.
7. If mounting the BC-80X0 cradle, insert the antenna in the appropriate hole on the body of the cradle and screw it clockwise until tight.

APPLYING RAPID POINT-TO-POINT CONFIGURATION LABEL (OPTIONAL)

A pre-printed barcode label is included in the package for rapid configuration of point-to-point applications. If you wish to use this method, apply this label to the seat provided on the BC-80X0 cradle as shown in the figure. See the PowerScan® M8300 Quick Reference Manual for the configuration procedure.



SYSTEM CONNECTIONS



CAUTION

Connections should always be made with power off!

The BC-80X0 cradle provides two interface connectors and a power supply connector as shown in the figure on the next page:



The RS-485 Network connection is available only on BC-8060 models. For details about this type of connection, refer to the PowerScan® D8330/M8300 Reference Manual.

To connect the BC-80X0 cradle to the Host through the multi-interface connector, use the cable corresponding to the desired interface type.

CONNECTING AND DISCONNECTING THE BC-80X0 INTERFACE CABLE

The BC-80X0 can be connected to a Host by means of an RS-232, USB, Wedge or Pen cable, which must be simply plugged into the Host connector, visible on the front panel of the cradle.

To disconnect the cable, insert a paper clip or other similar object into the hole corresponding to the Host connector on the body of the cradle. Push down on the clip while unplugging the cable. Refer to the following figure:

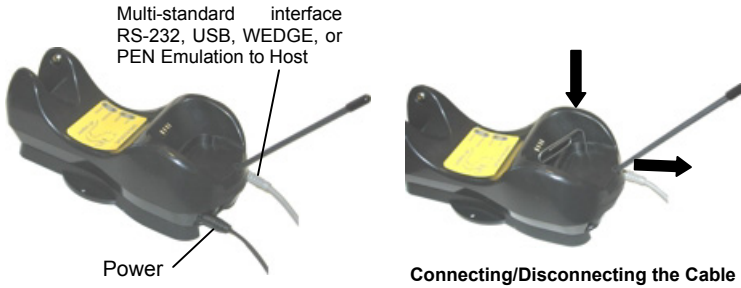

RS-232

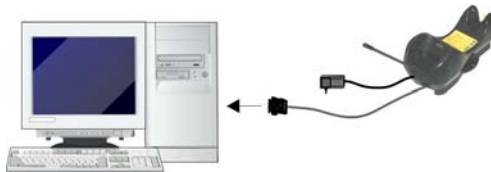

USB



WEDGE

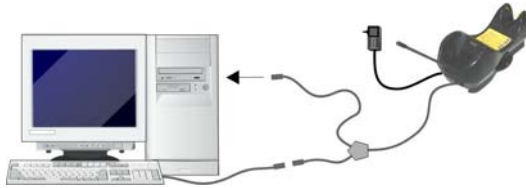

PEN

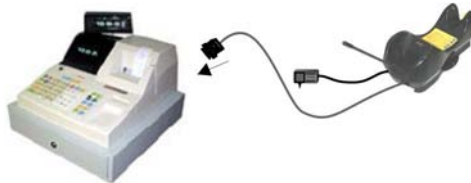

C-BOX

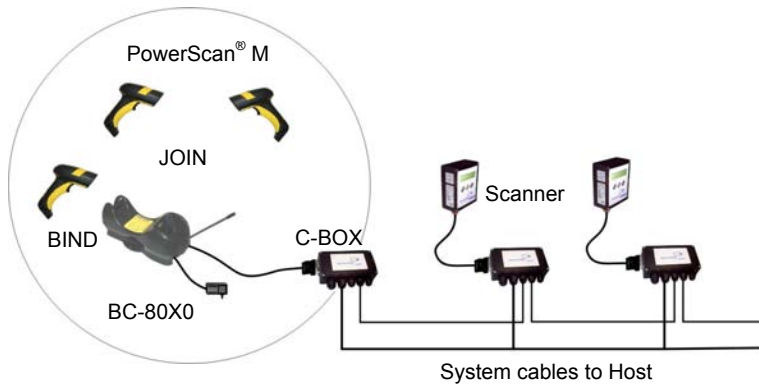

BC-80X0 CONFIGURATION

The BC-80X0 configuration can be performed in three ways: by using the Datalogic Aladdin™ software configuration program, by sending configuration strings from the Host PC via the RS-232 or USB-COM interface or by reading configuration barcodes with the PowerScan® M reader.

DATALOGIC ALADDIN™

Datalogic Aladdin™ is a multi-platform utility program providing a quick and user-friendly configuration method via the RS-232/USB-COM interface. It also allows upgrading the software of the connected device (see the Datalogic Aladdin™ Help On-Line for more details).

SERIAL CONFIGURATION

By connecting the BC-80X0 to a PC through an RS-232 or USB-COM interface cable it is possible to send configuration strings from the PC to BC-80X0.

CONFIGURATION BARCODES

Once you have performed system connection and PowerScan® M reader configuration, you can configure the BC-80X0 cradle by reading configuration barcodes. **Apply power to the BC-80X0.**

For the PowerScan® M configuration, refer to the "PowerScan® M8300 Quick Reference".

To configure the BC-80X0 using the PowerScan® M reader (the one paired to the cradle with the **Bind** command), follow the procedure according to the interface selected.

RESTORE DEFAULT

RESTORE BC-80X0 DEFAULT



To change the defaults refer to the "PowerScan® D8330/M8300 Reference Manual", or to the Datalogic Aladdin™ Configuration program, both downloadable from the website.

INTERFACE SELECTION

Select one of the interface codes according to your application.

USB INTERFACE SELECTION

USB-KBD



USB-KBD – ALT-mode



USB-COM*



USB-IBM-Hand Held



USB-IBM Table top



USB KBD-APPLE



* When configuring USB-COM, the relevant files and drivers must be installed from the USB Device Installation Software, which can be downloaded from the web site <http://www.scanning.datalogic.com>.

PEN EMULATION INTERFACE SELECTION

PEN



INTERFACE SELECTION

Select one of the interface codes according to your application.

RS-232 INTERFACE SELECTION

RS-232 Standard



Nixdorf Mode A



Fujitsu



ICL Mode



WEDGE INTERFACE SELECTION

Wedge IBM AT or PS/2 PCs



PC Notebook



PC Notebook - ALT mode



IBM AT - ALT mode



Interfaces for IBM XT and IBM Terminals 3151, 347X and 348X can be selected from the PowerScan D8330/M8300 Reference Manual available online at <http://www.scanning.datalogic.com>.

KEYBOARD NATIONALITY

USB-KBD and Wedge users should select one of the following wedge keyboard nationality codes according to your keyboard.

Belge



Deutsch



English



Español



Français



Italiano



Svenskt



USA (Default)



The following Keyboard Nationality selections are only valid for IBM AT compatible PCs:

Japanese



Russian (Latin)



Russian (Cyrillic)



Hungarian



Slovenian, Croatian, Serbian (Latin)



Romanian



Czech Republic



DATA FORMAT TERMINATORS

For your convenience, some common Terminators are given below. For other Header/Terminators selections, Data Format and Advanced Data Format parameters see the PowerScan[®] D8330/M8300 Reference Manual.

CR-LF



Enter



Tab



None



BC-80X0 DEFAULT CONFIGURATION

USB-KBD DEFAULT SETTINGS

USA keyboard, FIFO enabled, inter-character and inter-code delays disabled, USB keyboard speed normal.

DATA FORMAT: code identifier disabled, code length not transmitted, character replacement disabled, reader and cradle address stamping disabled, reader and cradle address delimiter disabled, time stamping disabled, time stamping delimiter disabled, no header, terminator = ENTER.

RS-232 DEFAULT SETTINGS

9600 baud, no parity, 8 data bits, 1 stop bit, no handshaking, ack/nack protocol disabled, FIFO enabled, delay disabled, 5 sec. rx timeout

DATA FORMAT: code identifier disabled, code length not transmitted, character replacement disabled, reader and cradle address stamping disabled, reader and cradle address delimiter disabled, time stamping disabled, time stamping delimiter disabled, no header, terminator = CR-LF.

WEDGE DEFAULT SETTINGS

USA keyboard, Caps Lock off, Caps Lock Auto-Recognition enabled, num lock unchanged, inter-character and intercode delay disabled, control character emulation = ctrl+shift+key.

DATA FORMAT: code identifier disabled, code length not transmitted, character replacement disabled, reader and cradle address stamping disabled, reader and cradle address delimiter disabled, time stamping disabled, time stamping delimiter disabled, no header, terminator = ENTER.

PEN DEFAULT SETTINGS

Interpret operating mode, conversion to code 39, output level normal, idle level normal, minimum output pulse 600 μ s, overflow medium, inter-block delay disabled.

NETWORK PARAMETERS

RS-485 network disabled (for BC-8000 only).

OPERATING TEST

Read the TEST codes below.

EAN-8



EAN-13



Code 39 (Normal)



Code 128



Interleaved 2 of 5



YOUR SYSTEM IS NOW READY TO READ CODES AND TO SEND THE DATA TO THE HOST.

TECHNICAL FEATURES

BC-80X0		
Electrical Features		
Supply Voltage External Power Host Power	10..30 VDC 5 VDC ±10%	
Power Consumption External Power Host Power	max. 10 W (charging) * max. 500 mA (charging)	
Indicators	Ext. Power/Data yellow LED Host Power/Data yellow LED Reader batt. state green/red LED Spare batt. state green/red LED (BC-8060 only) beeper	
Time of Recharge External Power Host Power	max. 4 hours with 2150 mAh Li-Ion battery max. 10 hours with 2150 mAh Li-Ion battery	
Radio Features	European Models	USA Models
Radio frequency	433.92 MHz	910 MHz
Bit Rate	19200 baud	36800 baud
Range (in open air)	50 m	30 m
Environmental Features		
Working Temperature Radio Battery Charging	-20° to +50 °C / -4° to +122 °F 0° to +40 °C / +32° to +104 °F	
Storage Temperature	-20° to +70 °C / -4° to +158 °F	
Humidity	90 % non condensing	
Protection Class	IP40	
Mechanical Features		
Weight without mounting base	about 380 g / 13.4 oz	
Dimensions (without antenna)	240 x 108 x 95 mm / 9.44 x 4.25 x 3.74 in	
Material	ABS	

* Having a switching regulator inside, the BC-80X0 draws the same power, regardless of the supply voltage. i.e. as the input voltage increases the current drawn decreases.

System Configuration	BC-80X0	STARGATE™
Max number of devices per base station	32	255
Max number of devices in the same reading area	2000	
	BC-8060	STARGATE™
Max number of base stations in network	16 (including cradle Master)	

WARRANTY

Datalogic warrants this product against defects in workmanship and materials, for a period of 3 years from the date of shipment, provided that the product is operated under normal and proper conditions.

Datalogic has the faculty to repair or replace the product; these provisions do not prolong the original warranty term. The warranty does not apply to any product that has been subject to misuse, accidental damage, unauthorized repair or tampering.

SERVICE AND SUPPORT

Datalogic provides several services as well as technical support through its website. Log on to **www.scanning.datalogic.com** and click on the [links](#) indicated for further information including:

- **PRODUCTS**

Search through the links to arrive at your product page where you can download specific **Manuals** and **Software & Utilities** including:

- **Datalogic Aladdin™**, a multi-platform utility program that allows device configuration using a PC. It provides RS-232 interface configuration as well as configuration barcode printing.

- **SERVICE & SUPPORT**

- **Technical Support** - Product documentation and programming guides and Technical Support Department in the world
- **Service Programs** - Warranty Extensions and Maintenance Agreements
- **Repair Services** - Flat Rate Repairs and Return Material Authorization (RMA) Repairs.
- **Downloads** – Manuals & Documentation, Data Sheets, Product Catalogues, etc.

- **CONTACT US**

Information Request Form and Sales & Service Network

COMPLIANCE

This device must be opened by qualified personnel only.

POWER SUPPLY

This device is intended to be supplied by a UL Listed/CSA Certified Power Unit marked "Class 2" or LPS power source rated 10-30 V DC, minimum 1 A, which supplies power directly to the cradle.

FCC COMPLIANCE

Modifications or changes to this equipment without the expressed written approval of Datalogic could void the authority to use the equipment.

This device complies with PART 15 of the FCC Rules. Operation is subject to the following two conditions: (1) This device may not cause harmful interference, and (2) this device must accept any interference received, including interference which may cause undesired operation.

This device contains FCC ID U4F0015.

RADIO COMPLIANCE

Contact the competent authority responsible for the management of radio frequency devices of your country to verify any possible restrictions or licenses required.

Refer to the web site <http://europa.eu.int/comm/enterprise/rtte/spectr.htm> for further information.



WEEE COMPLIANCE

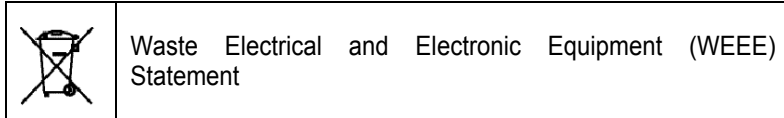

English

For information about the disposal of Waste Electrical and Electronic Equipment (WEEE), please refer to the website at www.scanning.datalogic.com.

Italian

Per informazioni sullo smaltimento delle apparecchiature elettriche ed elettroniche consultare il sito Web www.scanning.datalogic.com.

French

Pour toute information relative à l'élimination des déchets électroniques (WEEE), veuillez consulter le site internet www.scanning.datalogic.com.

German

Informationen zur Entsorgung von Elektro- und Elektronik- Altgeräten (WEEE) erhalten Sie auf der Webseite www.scanning.datalogic.com.

Spanish

Si desea información acerca de los procedimientos para el desecho de los residuos del equipo eléctrico y electrónico (WEEE), visite la página Web www.scanning.datalogic.com.

Portuguese

Para informações sobre a disposição de Sucatagem de Equipamentos Elétricos e Eletrônicos (WEEE -Waste Electrical and Electronic Equipment), consultar o site web www.scanning.datalogic.com.

Chinese

有关处理废弃电气电子设备 (WEEE) 的信息, 请参考Datalogic公司的网站:
<http://www.scanning.datalogic.com>.

Japanese

廃電気電子機器 (W E E E) の処理についての関連事項はDatalogicのサイト
www.scanning.datalogic.com, **をご参照下さい。**

Datalogic Scanning, Inc.
959 Terry Street
Eugene, OR 97402
USA



dichiara che
declares that the
déclare que le
bescheinigt, daß das Gerät
declare que el

BC-80X0, RF Base Charger

e tutti i suoi modelli
and all its models
et tous ses modèles
und seine Modelle
y todos sus modelos

sono conformi alla Direttiva del Consiglio Europeo sottoelencata:
are in conformity with the requirements of the European Council Directive listed below:
sont conformes aux spécifications de la Directive de l'Union Européenne ci-dessous:
der nachstehenden angeführten Direktive des Europäischen Rats entsprechen:
cumple con los requisitos de la Directiva del Consejo Europeo, según la lista siguiente:

1999/5/EEC R&TTE

Questa dichiarazione è basata sulla conformità dei prodotti alle norme seguenti:
This declaration is based upon compliance of the products to the following standards:
Cette déclaration repose sur la conformité des produits aux normes suivantes:
Diese Erklärung basiert darauf, daß das Produkt den folgenden Normen entspricht:
Esta declaración se basa en el cumplimiento de los productos con las siguientes normas:

ETSI EN 301 489-3 v1.4.1, August 2002:	ELECTROMAGNETIC COMPATIBILITY AND RADIO SPECTRUM MATTERS (ERM); ELECTROMAGNETIC COMPATIBILITY (EMC) STANDARD FOR RADIO EQUIPMENT AND SERVICES; PART 3: SPECIFIC CONDITIONS FOR SHORT-RANGE DEVICES (SRD) OPERATING ON FREQUENCIES BETWEEN 9 KHZ AND 40 GHZ
ETSI EN 300 220-3 v1.1.1, September 2000:	ELECTROMAGNETIC COMPATIBILITY AND RADIO SPECTRUM MATTERS (ERM); SHORT RANGE DEVICES (SRD); RADIO EQUIPMENT TO BE USED IN THE 25 MHZ TO 1000 MHZ FREQUENCY RANGE WITH POWER LEVELS RANGING UP TO 500 MW; PART 3: HARMONIZED EN COVERING ESSENTIAL REQUIREMENTS UNDER ARTICLE 3.2 OF THE R&TTE DIRECTIVE
EN 60950-1, December 2001:	INFORMATION TECHNOLOGY EQUIPMENT – SAFETY – PART 1: GENERAL REQUIREMENTS

December 20th, 2007