

Welcome to the World of
E-Collar Technologies, Inc.

802TS/1202TS
Owner's Manual

VISIT GUN DOG SUPPLY.COM | ORDER AN 802TS
SEE OTHER E-COLLAR TECHNOLOGY PRODUCTS

Welcome to the World of E-Collar Technologies, Inc.

802TS/1202TS Owner's Manual

802TS/1202TS

Remote Education Collar

Thank you for purchasing the 802TS/1202TS Remote Education Collar from E-Collar Technologies, Inc. We have made every attempt to provide you with the most technologically advanced product using the most stringent quality and manufacturing standards.

We are confident you will be pleased with the results you will attain with the 802TS/1202TS Two Dog Remote.

Please remember you will get better results with the use of lower stimulation combined with consistent training techniques. The use of high levels of stimulation should only be used as a last resort and in life-threatening situations.

Good luck with your training and please feel free to contact us should you have any questions.

1-855-326-5527 or 1-855-ecollar

CHARACTERISTICS

- Range : 1 Mile (802TS) / 1 Mile Plus (1202TS)
- Three Stimulation Modes Supported
(Momentary, Continuous, and Combo Mode)
- Tapping Sensation
- Employs Ni-MH Rechargeable Batteries
- Convenient Intensity Dial for Quick Adjustment
- Stimulation Levels Adjustable from 0 to 100
- Collar Receiver Light for Night Tracking
- Lock and Set Stimulation Feature
- Stimulation Boosting Mode Provides Instant Responses to
Emergency Situations
- User Adjustable Boosting Levels
- Completely Waterproof

- Transmitter

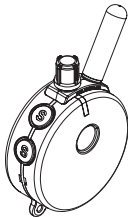

- 2 Collar Receivers with Strap and 5/8" Contact Points

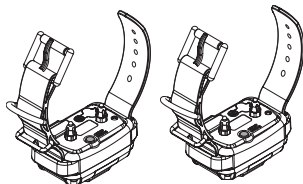

- Battery Charger and splitter cable



- Owner's Manual



- Contact Points 3/4"

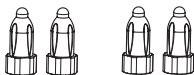

- Test Light

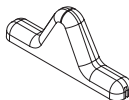

- Contact Point Tool



- Lanyard

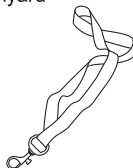

TABLE OF CONTENTS

• Safety and General Information	05
• Transmitter Parts	06
• Collar Receiver Parts	07
• Charging the Batteries	08
• Turning Your E-Collar On/Off	11
• The LCD Display Features	12
• Button Functions	13
• Changing the Intensity Level of Stimulation	18
• Lock/Unlock the Stimulation Intensity Level	21
• Indicator Light	22
• Lost Transmitter Mode	23
• Testing Your E-Collar	24
• Reception	25
• Replacing the Contact Points	26
• Correctly Fitting the Collar	27
• Warranty	28
• Accessories	29

SAFETY AND GENERAL INFORMATION

- The 802TS/1202TS Education Collar complies with all National and International Standards and Guidelines for human exposure to radio frequency electromagnetic energy.
- Nearly all electronic devices are susceptible to electromagnetic interference (EMI) if inadequately shielded or designed without precautions to EMI.
- 802TS/1202TS E-Collar transmitters manufactured by E-Collar Technologies, Inc. comply with Article 15 of the FCC rules and operate under Part 95 of FCC regulations.

- **IMPORTANT NOTICE**

1. To avoid Electromagnetic Interference and/or compatibility conflicts, please turn off your transmitter and collar receiver in any facility where posted notices instruct you to do so.
Never use your equipment in close proximity of a Hospital or Health Care Facility or enter the facility without turning off both units.
2. An FCC license is not needed to operate 802TS/1202TS E-Collar transmitters. However, any change or modification made to the transmitter, including the supplied antenna, without the expressed written approval of E-Collar Technologies, Inc. could void your authority to operate.

TRANSMITTER PARTS

 See pages 13 - 17 for button functions

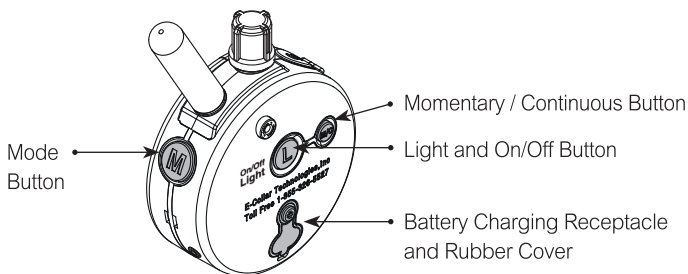
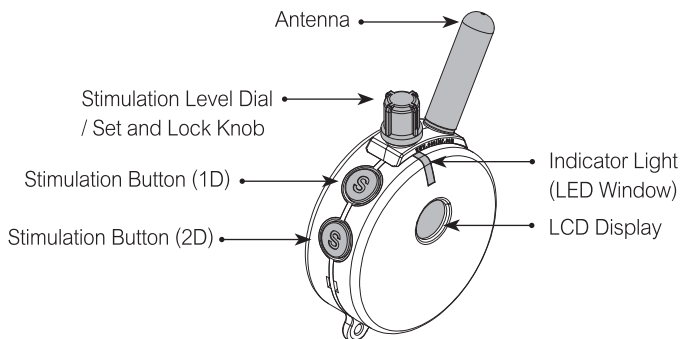

COLLAR RECEIVER PARTS

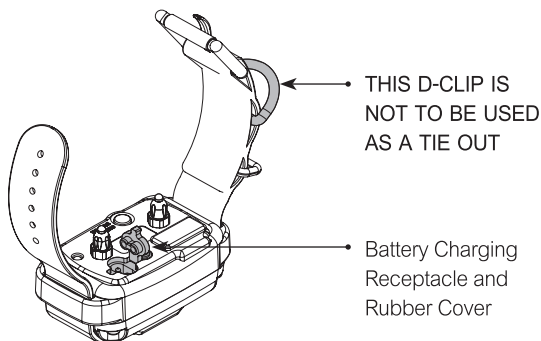
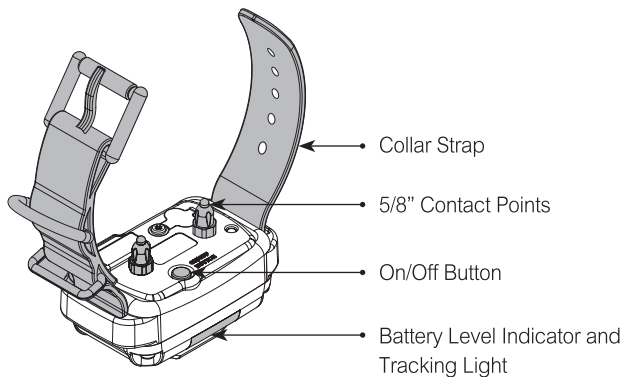

CHARGING THE BATTERIES

The most important fact to know about Nickel Metal Hydride batteries is they do not like to be fully discharged, permanent damage may occur. If this happens to your system it is best to charge them up (10 – 12 hours only) and discharge (receiver and transmitter on) the system one time. It is best to charge them before they get to yellow, every night is acceptable. Every 6 months it is good practice to let them run down to red and immediately charge them up.

Long term storage is not suggested, the batteries will need to be replaced unless the unit is charged regularly. At least once a month is the preferred charging regimen for stored e-collars with NiMH batteries.

Battery Charger and Splitter Cable

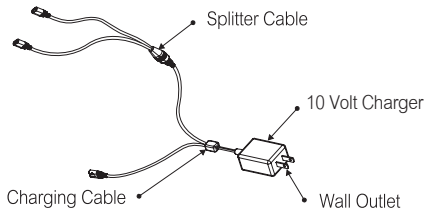

CHARGING THE BATTERIES

Transmitter Battery Charging
Receptacle and Rubber Cover

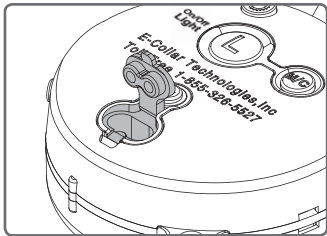

Collar Receiver Battery Charging
Receptacle and Rubber Cover

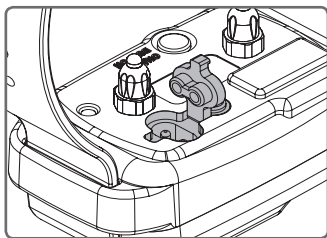

- The indicator light will be solid red during charge and remain solid red even after units are fully charged.
- The charge plug has a small indentation on it that guides the charger connector into the correct position.

CHARGING THE BATTERIES

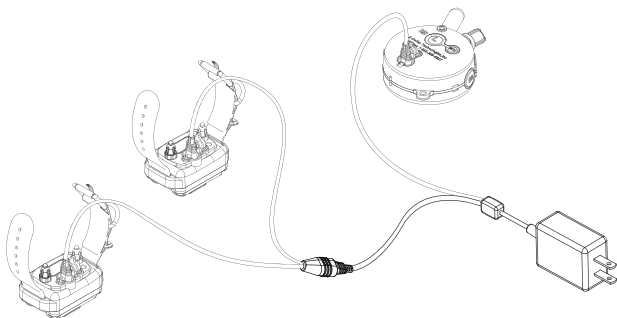

- **Battery Care:**

It is important to fully charge the batteries and fully discharge them for the first three uses. After that it is not necessary to fully discharge the batteries with each use, because NiMH do not exhibit “memory effect” like other rechargeable battery types.

It is recommended that every six months you recondition the batteries by fully discharging them and then fully charging them, this will ensure you get the rated 500 charges per battery.

TURNING YOUR E-COLLAR ON/OFF

COLLAR RECEIVER ON/OFF BUTTON

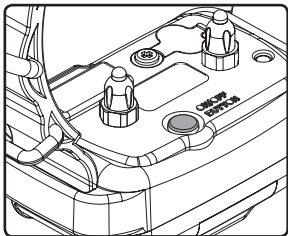

- To turn the Collar Receiver On or Off :
Press the power button to turn collar receiver on/off.

TRANSMITTER ON/OFF BUTTON

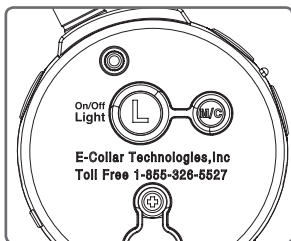

- To turn the Transmitter On or Off :
Press the "L" light button for more than 2 seconds.
If "L" light button is pressed less than 0.5 seconds, it will turn On/Off Tracking lights of Collar Receiver.

THE LCD DISPLAY FEATURES

Press down on the Stimulation Level Knob or press any button to wake up the LCD display. Please note that if the collar receiver is on, pressing the stimulation buttons and/or the mode button will trigger the collar receiver.

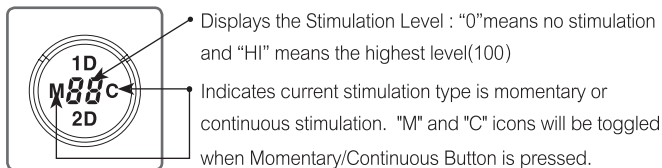

- In 1D mode, the 1D icon will blink indicating the stimulation is ready to be changed. If the 1D icon is solid, it has been locked into a specific stimulation level as displayed on the LCD. Release the stimulation lock by clicking down on the rotary dial until the 1D icon begins to blink; now you can change the stimulation to a new level. The new selected level can be locked by clicking down on the rotary dial until the 1D icon stops blinking. In 1D mode, the 2D icon will not be displayed unless dog 2 stimulation is locked
- In 2D mode, the 2D icon will blink when the stimulation is ready to be changed. If the 2D icon is solid, it has been locked into a specific stimulation level as displayed on the LCD. Release the stimulation lock by clicking down on the rotary dial until the 2D icon begins to blink; now you can change the stimulation to a new level. The new selected level can be locked by clicking down on the rotary dial until the 2D icon stops blinking. In 2D mode, the 1D icon will not be displayed unless dog 1 stimulation is locked



- In Tapping Sensation mode, the LCD displays "T" as shown in the right picture and you cannot change the stimulation level.

BUTTON FUNCTIONS

TRANSMITTER

The 802TS/1202TS transmitter is equipped with five control buttons, LCD display, and an adjustable dial. For long range use hold the transmitter up like the Statue of Liberty and never allow the antenna to touch anything as it will decrease the range. Power lines and foliage will also reduce the range.

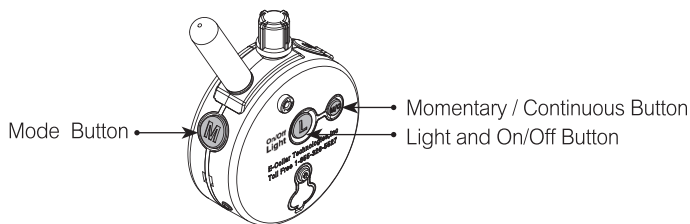
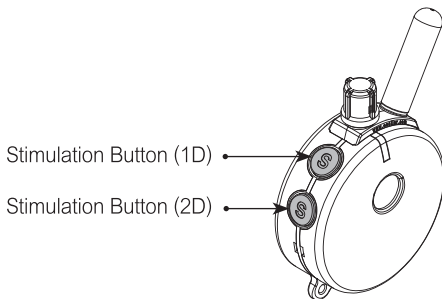

BUTTON FUNCTIONS

Two Programmable Modes are provided based on the status of M/C button when Mode button(M) is in 1D or 2D state. Two Stimulation buttons will be working differently.

Mode(M) Button	Stimulation (1D or 2D)		Tapping Sensation
M/C Button	Momentary Mode	Continuous Mode	N/A
Display	M	C	TS
S (1D/Black)	1Dog Momentary	1Dog Continuous	1Dog TS
S(1D/Black)+Mode	1Dog Momentary Booster	1Dog Continuous Booster	N/A
S (2D/Red)	2Dog Momentary	2Dog Continuous	2Dog TS
S(2D/Red)+Mode	2Dog Momentary Booster	2Dog Continuous Booster	N/A
L	1D Mode : 1Dog Light 2D Mode : 2Dog Light		N/A

Mode Button “M”

- Mode Button allows the user to change modes, cycling between 1D Mode to Tapping Sensation Mode, Tapping Sensation Mode to 2D Mode, 2D Mode to Tapping Sensation Mode, and Tapping Sensation mode to 1D Mode as shown in the diagram.



BUTTON FUNCTIONS

- In 1D Mode, you can change the intensity level of 1D by rotating the dial and locking it.
(See “LOCK/UNLOCK THE STIMULATION INTENSITY LEVEL” for details)
The intensity level of 2D will be same as that of 1D unless it is locked.
- In Tapping Sensation Mode, you can send only a tapping sensation to each collar receiver. We purposely made it easy to switch back and forth from tapping sensation to stimulation with one button control.
- In 2D Mode, you can change the intensity level of 2D by rotating the dial and locking it. The intensity level of 1D will be same as that of 2D unless it is locked.

Momentary/Continuous Button “M/C”

- M/C Button on the backside of the transmitter allows the user to switch between Momentary Stimulation and Continuous Stimulation.
- If Continuous Stimulation is selected, pressing stimulation buttons (1D or 2D) will send stimulation to the collar receiver for the duration of the button being pressed. After 10 seconds the Over-Stimulation feature will stop the stimulation until the button is released and pressed again.

Stimulation Button (1D)

- In 1D/2D Mode, Sends momentary or continuous stimulation to the Dog 1 collar receiver based on the state of Momentary/Continuous Button.
- If Mode Button(M) is pressed while the Stimulation Button(1D) is pressed, it will send boosting stimulation.

BUTTON FUNCTIONS

- In Tapping Sensation Mode, Sends a tapping sensation to the Dog 1 collar receiver.
- If the current mode is 2D mode, the mode will be changed to 1D mode by pressing the Mode(M) Button 2 times or by stimulating Dog 1.
- In 1D Mode, you can jump to 2D Mode by pressing the Mode(M) Button 2 times and vice versa.

Stimulation Button (2D)

- Sends momentary and continuous stimulation to the Dog 2 collar receiver based on the state of Momentary/Continuous Button.
- If Mode Button(M) is pressed while Stimulation Button(2D) is pressed, it will send boosted stimulation.
- In Tapping Sensation Mode, the 2D Button Sends a tapping sensation to the Dog 2 collar receiver.
- If the current mode is 1D mode, the mode will be changed to 2D mode by pressing the Mode(M) Button 2 times or by Stimulating Dog 2.

Light Button(On Back) “L”

- When pressed less than 0.5 seconds, it will turn On or Off the high intensity night tracking light which is good for finding your dog after dark.
 - * In 1D Mode, it will turn ON/OFF Dog 1 collar receiver light.
 - * In 2D Mode, it will turn ON/OFF Dog 2 collar receiver light.
 - * In Tapping Sensation Mode, Light ON/OFF Function is disabled.
 - * 1st pressing will make the collar receiver light flashing.
 - * 2nd pressing will make the collar receiver light turn solid.
 - * 3rd pressing will make the collar receiver light turn off.
- When pressed for more than 2 seconds, it will turn On or Off the transmitter.
- When the button is pressed, “L” will be displayed.

BUTTON FUNCTIONS

How to Change Boosting Level

- 802TS/1202TS provides Boosting Stimulation Function for the emergencies.

- Default boosting level is 20, it can be easily changed by following the procedure given below.

* Dog 1

1. Change the mode to Momentary Mode. (Press M/C button until "M" is displayed).
2. Change the intensity level to "0"
3. Press S(1D/Black) button for more than 5 sec to enter into Booster Level Change Mode for Dog 1. The intensity level "0" will start to blink.
4. Rotate the dial to change the boosted level. (The range of available levels is from 1 to 60) Use 1 to 20 for small breeds and 20 to 40 larger more stubborn breeds.
5. Press S(1D/Black) button again to save the new level and exit from Booster Level Change Mode.
6. If no button is pressed or 20 seconds passes, Booster Level Change Mode will be cancelled.

* Dog 2

1. Change the mode to Momentary Mode. (Press M/C button until "M" is displayed)
2. Change the intensity level to "0"
3. Press S(2D/Red) button for more than 5 sec and enter into the Booster Level Change Mode for Dog 2. The intensity level "0" will start to blink.
4. Rotate the dial to change the boosted level. (The range of available level is from 1 to 60) Use 1 to 20 for small breeds and 20 to 40 larger more stubborn breeds.
5. Press S(2D/Red) button again to save new level and exit from Booster Level Change Mode.
6. If no button is pressed or 20 seconds passes, Booster Level Change Mode will be cancelled.

18

CHANGING THE INTENSITY LEVEL OF STIMULATION

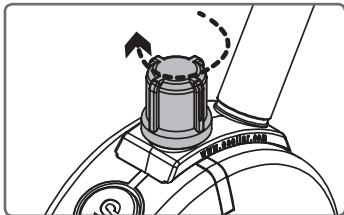

Rotating clockwise increases the stimulation level and conversely, rotating counter-clockwise lowers the stimulation level.

It is highly recommended that the

user practices changing levels and modes before putting the collar receiver on the dog.

Setting the correct stimulation level for your dog is very important.

To set your “conditioning” stimulation level, put the collar receiver (see page 27 for proper fitting technique) on your dog. Let him/her get used to the collar receiver for a couple of hours.

While watching your dog, turn the level to “0” and press the continuous stimulation button. Slowly turn the stimulation up at a rate of approximately 2-3 levels per second. When your dog first perceives the stimulation, usually between 5 and 30, release the button.

This is your “conditioning” stimulation level. You may need to increase the “conditioning” level a few levels to get your dog to respond, some dogs are more stubborn and need more stimulation. The “corrective” level is typically 10 to 30 levels higher than the “conditioning” level.

CHANGING THE INTENSITY LEVEL OF STIMULATION

USING THE E-COLLAR IN CONTINUOUS AND MOMENTARY MODES

For example, if you want your dog to come to you and heel, you can hold the button down until your dog comes and heels or if jumping is an issue, you can hold the button down anytime their front paws are off the ground. Your dog will learn that he/she controls the stimulation.

Setting the “Corrective” stimulation level is a little more difficult due to the wide differences in temperaments and stimulation tolerance among the many breeds of dogs. On average, it is normally 20 to 40 levels higher than the “Conditioning” level.

This higher level will only be used in “Momentary” mode as not to over-stimulate your dog.

CHANGING THE INTENSITY LEVEL OF STIMULATION

IMPORTANT TRAINING TIPS

E-Collars should be used to reinforce commands your dog already knows. It is not a replacement for basic leash obedience training, but a tool to allow you to better communicate to your dog.

For best results, use the least amount of stimulation required to get compliance from your dog. A calm and consistent approach to training will always produce better long term results.

It is highly recommended that aggressive dogs be taken to a professional trainer for evaluation before e-collar use.

There are many different e-collar training techniques recommended by a variety of professional trainers. We believe you, the owner of the dog, can best determine the most successful technique for your dog. YouTube has many videos demonstrating these varying techniques by simply searching “e-collar training” or “remote dog training techniques”.

Good Luck with your training!

- * CAUTION : Do not put the 802TS/1202TS E-Collar receiver on a human being.
- * WARNING : E-Collar Technologies, Inc. is not responsible for any misuse of the 802TS/1202TS E-Collar and loss and damages as a result of a dog bite. Aggressive dogs should be evaluated by a professional trainer before e-collar use.

LOCK/UNLOCK THE STIMULATION INTENSITY LEVEL

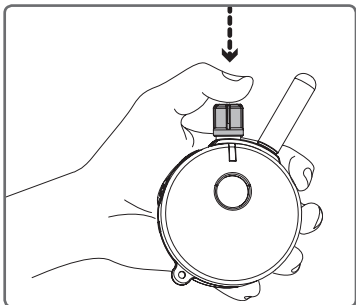

How to Lock/Unlock the Stimulation Level

This feature is useful when controlling two dogs simultaneously and you want to have different stimulation levels for each dog.

In 1D Mode, you can see the 1D icon is blinking on the LCD display. Set the desired stimulation level and then push down on the top of the stimulation dial until you see "1D" icon stop flashing.

If the stimulation level doesn't change when you rotate the stimulation knob, you have successfully locked the stimulation level of Dog 1.

Change the mode to 2D Mode by pressing the Mode Button twice and repeat the previous step. The "2D" icon light on the bottom portion of the LCD display will stop flashing. when you have successfully locked the stimulation level of Dog 2.

To unlock the stimulation level simply press the stimulation knob again and it will unlock the stimulation level of the dog selected by the mode button.

INDICATOR LIGHT

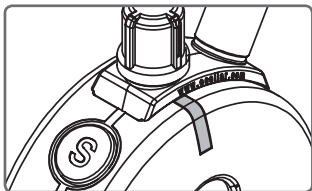

- **TRANSMITTER INDICATOR LIGHT**

Battery Charge level is signified by the flashing light going from “green” (ready for use) to “amber” (need to charge soon) and then to “red” (charge immediately). When any of the function buttons are pressed the indicator light will turn “red” to signify activation.

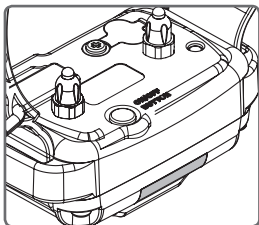

- **COLLAR RECEIVER INDICATOR LIGHT**

Battery Charge level is signified by the flashing light going from “green” (ready for use) to “amber” (need to charge soon) and then to “red” (charge immediately). When any of the function buttons of the transmitter are pressed, the indicator light on the collar receiver will flicker “red” indicating a control signal has been successfully received.

LOST TRANSMITTER MODE

Your 802TS/1202TS E-Collar transmitter allows the user to turn on a 6 hour timer. After 6 hours the transmitter will begin beeping providing the ability to locate the transmitter in tall grass.

Lost transmitter mode is activated by first pressing light button and then simultaneously pressing the stimulation Button(1D) when the intensity level is zero. Three short beeps will sound confirming the activation of the locator timer.

Lost transmitter mode is turned off by first pressing light button and then simultaneously pressing the stimulation Button(2D) when the intensity level is zero. Two short beeps will sound confirming the timer has been turned off.

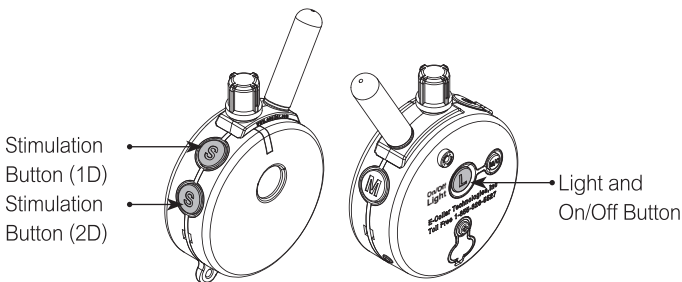

Turn off the lost transmitter beeper by simply turning the transmitter off and back on.

TESTING YOUR E-COLLAR

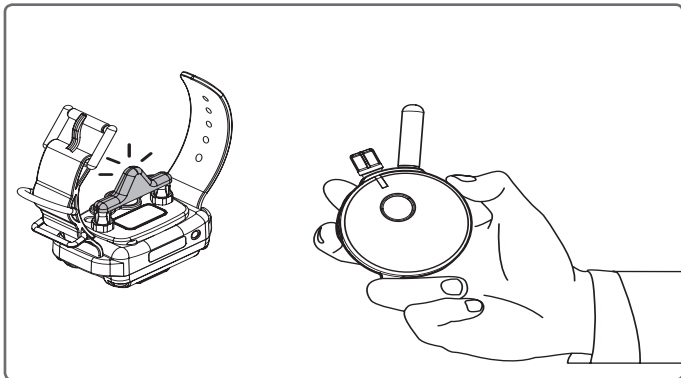

Hold the test light onto the contact points as shown in the above figure. With both units on and green lights flashing, press the stimulation buttons at Continuous Mode while turning the stimulation up and down, the test light should brighten as you go higher in stimulation. The collar receiver light will flicker red while the stimulation is on. Next, change the mode to Tapping Sensation Mode and press the 1D stimulation button to test the tapping sensation feature on the collar receiver for Dog 1 and repeat for Dog 2. Your 802TS/1202TS E-Collar is ready to use.

RECEPTION

To obtain the maximum range hold the transmitter like the torch on the Statue of Liberty. Keep the antenna away from your body or fingers at all times, touching the antenna will greatly reduce the range.



[Long Range]



[Medium Range]



[Short Range]

REPLACING THE CONTACT POINTS

The standard 5/8" contact points are used for most dogs.

Thicker fur breeds require the longer 3/4" contact points.

Replace the 5/8" contact points by following the instructions below using the enclosed contact point tool.

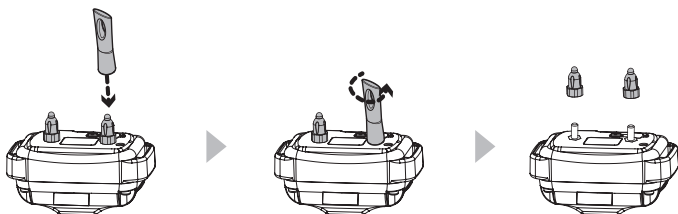

1. Loosen both contact points by rotating the contact point counter-clockwise using the contact point tool.

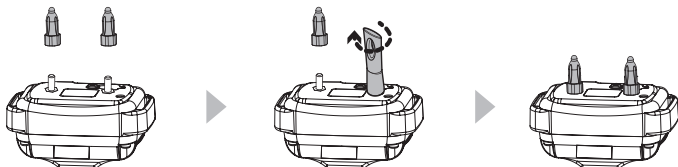

2. Install the 3/4" contact points onto the bolt and tighten the contact points by rotating them clockwise with the contact point tool.

* For short haired breeds such as boxers, dachshund, pit bulls, etc, please contact customer service and get the micro-probe contact points.

CORRECTLY FITTING THE COLLAR

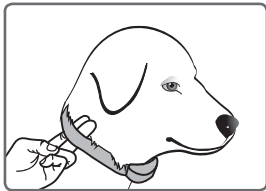

The collar should be adjusted to allow the “contact points” to have direct contact with the skin. You should be able to fit a couple of fingers between the collar strap and your dog.

Too tight poses the risk of skin irritation and discomfort.

Too loose and the contact points will not be able to administer the stimulation reliably and can cause skin irritation due to chafing.

Short hair breeds may need the micro-probes offered as an accessory item, contact customer service for details.

The optimal position for the collar receiver is on either side of the dog's windpipe.

IMPORTANT NOTICE

To prevent the occurrence of skin irritations the Collar Receiver should never be worn for more than 12 hours per day.

Should your dog experience skin irritations from over exposure to the contact points remove the collar receiver unit immediately and stop using your e-collar until all skin irritations are totally healed.

Antibiotic ointment will aid in the healing process. Some dog breeds have very thick fur that requires special contact points, please contact our customer service or visit www.ecollar.com for more information.

WARRANTY

To Register for the Limited Lifetime Warranty :

To register your 802TS/1202TS product, please log onto our website at www.ecollar.com, click on the warranty registration link and fill out the required information. Please register your product within 30 days of your purchase. If you do not have access to a computer, please call our toll free number of 1-855-326-5527 and one of our customer service representatives will register your product for you. In the event the product is not properly registered proof of purchase will be needed to obtain warranty work. Product returns without proper registration and proof of purchase will be subject to a warranty start date estimated by your units serial number. Misuse, improper maintenance, lost units are not covered by this warranty.

Limited Lifetime Warranty :

Your Limited Lifetime Warranty begins the date of the original purchase. For the first two years both parts and labor are covered 100%. After the two year replacement warranty has expired the Limited Lifetime Warranty will cover the material to repair your e-collar system not including the accessories and antennas. The labor and shipping costs are not included and are the responsibility of the customer. Labor fees will be calculated based on the extent of the work performed. The Limited Lifetime Warranty will expire 5 years from the date the model is discontinued by E-Collar Technologies, Inc. Any attempt by the user to repair or open the e-collar including battery replacement will void the warranty.

- Micro-Probes Contact Points



- Thick-Hair Contact Points



- Car Charger



- Belt Clip



CONTACT INFORMATION



E-Collar Technologies, Inc.

2120 Forrest Park Drive

Garrett, IN 46738

Toll-Free 1-855-326-5527

Toll-Free Fax 1-855-226-5527

www.ecollar.com

sales@ecollar.com

customerservice@ecollar.com

©0130923 E-Collar Technologies, Inc. All rights reserved.

802TS / 1202TS Owner's Manual

MEMO

MEMO

MEMO



E-Collar Technologies, Inc.

2120 Forrest Park Drive
Garrett, IN 46738-1887
1-855-326-5527 (Toll Free)
1-855-226-5527 (Toll Free Fax)
sales@ecollar.com

www.ecollar.com

Patents Pending

© 2013 E-Collar Technologies, Inc.



Thank you for Supporting American Workers