

GARMIN®



ALPHA® XL

Owner's Manual

Visit [Gun Dog Supply.com](http://GunDogSupply.com)
Order a Garmin Alpha XL
See other Garmin Products

© 2025 Garmin Ltd. or its subsidiaries

All rights reserved. Under the copyright laws, this manual may not be copied, in whole or in part, without the written consent of Garmin. Garmin reserves the right to change or improve its products and to make changes in the content of this manual without obligation to notify any person or organization of such changes or improvements. Go to www.garmin.com for current updates and supplemental information concerning the use of this product.

Garmin®, the Garmin logo, Alpha®, ANT+®, inReach®, and TracBack® are trademarks of Garmin Ltd. or its subsidiaries, registered in the USA and other countries. BaseCamp™, Garmin Adventurous Routing™, Garmin Explore™, Garmin Express™, Garmin PowerSwitch™, Garmin Response™, myTrends™, and tempe™ are trademarks of Garmin Ltd. or its subsidiaries. These trademarks may not be used without the express permission of Garmin.

Apple® and Mac® are trademarks of Apple Inc., registered in the U.S. and other countries. The BLUETOOTH® word mark and logos are owned by the Bluetooth SIG, Inc., and any use of such name by Garmin is under license. microSD® and the microSD logo are trademarks of SD-3C, LLC. Tripadvisor® is a registered trademark of Tripadvisor LLC. USB-C® is a registered trademark of USB Implementers Forum. Windows® is a registered trademark of Microsoft Corporation in the United States and other countries. Wi-Fi® is a registered trademark of Wi-Fi Alliance. Other trademarks and trade names are those of their respective owners.

Table of Contents

| | | | |
|---------------------------------------|-----------|---|-----------|
| Getting Started..... | 1 | Using Sleep Mode..... | 14 |
| Setting Up the Alpha System..... | 1 | Channel View..... | 14 |
| Device Overview..... | 1 | Changing the Dog ID..... | 15 |
| VHF Radio Information..... | 2 | Tracking Your Dog on the Map..... | 15 |
| Installation..... | 3 | Dog Status Icons..... | 15 |
| Installing the VHF Dock in Your | | Pro View..... | 16 |
| Vehicle..... | 3 | Navigating to Your Dog..... | 16 |
| Installing the External VHF | | Changing the Length of the Dog's | |
| Antenna..... | 4 | Track..... | 16 |
| Connecting the Mount and Navigator | | Location Alerts..... | 16 |
| to Vehicle Power..... | 5 | Setting Location Alerts..... | 16 |
| Turning the Device On or Off..... | 6 | Enabling or Disabling Location | |
| Main Menu..... | 7 | Alerts..... | 17 |
| Status Bar Icons..... | 8 | Editing Location Alerts..... | 17 |
| Opening an App..... | 8 | Dog Training..... | 17 |
| Acquiring GPS Signals..... | 8 | Selecting and Installing the Contact | |
| Using the On-Screen Buttons..... | 9 | Points..... | 17 |
| Adjusting the Volume..... | 9 | Removing the Contact Points..... | 17 |
| Adjusting the Screen Brightness..... | 9 | Collar Training..... | 18 |
| Changing the Keyboard..... | 9 | Training Methods..... | 18 |
| Setting the Time..... | 9 | Linear and Traditional | |
| | | Stimulation..... | 18 |
| | | Choosing the Correct Intensity | |
| | | Level..... | 18 |
| | | Training Menu..... | 19 |
| | | Moving the Training Menu | |
| | | Button..... | 19 |
| | | Customizing the Training | |
| | | Buttons..... | 19 |
| | | Using the Training Menu..... | 20 |
| | | Dog Training Options..... | 20 |
| Dog Tracking and Training..... | 10 | Contact Tracking..... | 20 |
| Dog Collar Device Setup..... | 10 | Turning On and Off the Transmitter..... | 20 |
| Methods to Add a Dog Collar Device to | | Methods to Add a Contact to the | |
| Your Navigator..... | 10 | Navigator..... | 21 |
| Adding a Dog to the Alpha XL | | Adding a Contact Using a Contact | |
| Navigator Using Wireless | | ID..... | 21 |
| Pairing..... | 10 | Adding a Contact Wirelessly From | |
| Adding a Dog Using the Track and | | Another Navigator..... | 21 |
| Control Codes..... | 11 | Sharing a Dog Wirelessly..... | 21 |
| Adding a Dog Wirelessly From | | Finding Your Contact ID..... | 21 |
| Another Navigator..... | 11 | Changing Your Contact ID..... | 21 |
| Sharing a Dog Wirelessly..... | 11 | Updating a Contact ID..... | 22 |
| Managing a Group..... | 12 | Tracking a Contact..... | 22 |
| Editing Dog Information..... | 12 | Initiating an Emergency Alert..... | 22 |
| Changing the Dog Name..... | 12 | Sending a Message to Your | |
| Changing the Color of the Dog's | | Contacts..... | 22 |
| Track..... | 12 | | |
| Changing the Dog Type..... | 12 | | |
| Removing a Dog..... | 12 | | |
| Fitting the Collar on Your Dog..... | 13 | | |
| Communication with the Dog Collar | | | |
| Device..... | 14 | | |
| Using a Dynamic Update Rate..... | 14 | | |

| | | | |
|--|-----------|--|--|
| Hunting with the Alpha System..... | 22 | | |
| Starting a Hunt..... | 23 | | |
| Active Hunt Metrics..... | 23 | | |
| Turning On the Collar Light..... | 23 | | |
| Turning On Rescue Mode..... | 23 | | |
| Off-Road Navigation Features..... | 23 | | |
| Adventurous Routing..... | 23 | | |
| Adventure Roads and Trails..... | 24 | | |
| Pitch and Roll..... | 24 | | |
| Calibrating Pitch and Roll..... | 25 | | |
| Adjusting Warning Angles..... | 25 | | |
| Enabling or Disabling Warning Angle Alerts..... | 25 | | |
| Viewing the Altimeter, Barometer, and Compass..... | 25 | | |
| Calibrating the Compass..... | 25 | | |
| inReach® Remote..... | 25 | | |
| Connecting an inReach Device..... | 26 | | |
| Sending a Text Message..... | 26 | | |
| SOS..... | 26 | | |
| Initiating an SOS Rescue..... | 26 | | |
| Canceling an SOS Rescue..... | 27 | | |
| Vehicle Profiles..... | 27 | | |
| Switching the Vehicle Profile..... | 27 | | |
| Choosing a Vehicle Profile..... | 27 | | |
| Adding a Vehicle Profile..... | 27 | | |
| Editing a Vehicle Profile..... | 27 | | |
| Adding Portable Propane Tanks..... | 28 | | |
| Routes..... | 28 | | |
| Starting a Route..... | 28 | | |
| Starting a Route to a Point on the Map..... | 28 | | |
| Planning a Route..... | 29 | | |
| Creating a Round-Trip Route..... | 29 | | |
| Navigating to a Saved Route..... | 29 | | |
| Your Route on the Map..... | 29 | | |
| Active Lane Guidance..... | 31 | | |
| Viewing Turns and Directions..... | 31 | | |
| Viewing the Entire Route on the Map..... | 31 | | |
| Changing Your Active Route..... | 32 | | |
| Adding a Stop to Your Route..... | 32 | | |
| Skipping the Next Stop on Your Route..... | 32 | | |
| Shaping Your Route..... | 32 | | |
| Editing Your Active Route..... | 32 | | |
| Saving Your Active Route..... | 32 | | |
| Avoiding Delays, Tolls, and Areas..... | 33 | | |
| Avoiding Traffic Delays on Your Route..... | 33 | | |
| Avoiding Toll Roads..... | 33 | | |
| Avoiding Toll Stickers..... | 33 | | |
| Avoiding Road Features..... | 33 | | |
| Custom Avoidances..... | 33 | | |
| Avoiding a Road..... | 33 | | |
| Avoiding an Area..... | 34 | | |
| Disabling a Custom Avoidance..... | 34 | | |
| Deleting Custom Avoidances..... | 34 | | |
| Taking a Detour..... | 34 | | |
| Stopping the Route..... | 34 | | |
| Going Home..... | 34 | | |
| Editing Your Home Location..... | 34 | | |
| Arriving at Your Destination..... | 35 | | |
| Parking Near Your Destination..... | 35 | | |
| Tracks..... | 35 | | |
| Recording Tracks..... | 35 | | |
| Following Your Most Recent Track..... | 35 | | |
| Converting a Track to a Route..... | 35 | | |
| Using the Map..... | 36 | | |
| Map Tools..... | 36 | | |
| Viewing a Map Tool..... | 36 | | |
| Up Ahead..... | 37 | | |
| Viewing Upcoming Locations..... | 37 | | |
| Customizing the Up Ahead Categories..... | 37 | | |
| Cities Ahead..... | 37 | | |
| Viewing Upcoming Cities and Exit Services..... | 37 | | |
| Viewing Upcoming Elevation Changes..... | 38 | | |
| Viewing Traffic Information..... | 38 | | |
| Viewing the Map Key..... | 38 | | |
| Viewing Trip Data..... | 38 | | |
| Viewing Trip Data from the Map..... | 38 | | |
| Customizing the Trip Data Fields..... | 38 | | |
| Resetting Trip Information..... | 38 | | |
| Viewing a Map Tool..... | 39 | | |
| Customizing the Map..... | 39 | | |

| | | | |
|--|-----------|--|-----------|
| Customizing the Map Layers..... | 39 | Deleting a Saved Location..... | 48 |
| Downloading Outdoor Maps+ | | Viewing Your Saved Items..... | 49 |
| Content..... | 39 | Sharing a Saved Item..... | 49 |
| Viewing Your Collections on the | | Sharing Multiple Saved Items..... | 49 |
| Map..... | 39 | Synchronizing Garmin Account | |
| Changing the Map Data Field..... | 40 | Data..... | 50 |
| Changing the Map Buttons..... | 40 | Using the Apps..... | 50 |
| Changing the Map Perspective..... | 40 | Using the Competition Timer..... | 50 |
| Changing the Map Region..... | 40 | Wireless Cameras..... | 50 |
| Finding and Saving Locations..... | 41 | Pairing the Device with a Wireless | |
| Points of Interest..... | 41 | Camera..... | 50 |
| Finding a Location Using the Search | | Viewing the Camera..... | 50 |
| Bar..... | 42 | Aligning the Guidance Lines..... | 51 |
| Finding a Location by Category..... | 42 | Garmin PowerSwitch™ App..... | 52 |
| Navigating to Points of Interest Within | | Activating a Power Switch..... | 52 |
| a Venue..... | 42 | Turning Off All Switches..... | 52 |
| Location Search Results..... | 43 | Customizing a Button..... | 53 |
| Changing the Search Area..... | 44 | Assigning a Switch to a Control | |
| Finding Parking Near Your Current | | Input..... | 53 |
| Location..... | 44 | Adding a Custom Layout..... | 53 |
| Finding Parking Near a Specified | | Adding a Button to a Custom | |
| Location..... | 45 | Layout..... | 54 |
| Finding an Address..... | 45 | Arranging Buttons In a Custom | |
| Finding a Location Using | | Layout..... | 54 |
| Coordinates..... | 45 | Deleting a Custom Layout or | |
| Finding Fuel Stations and Prices..... | 46 | Button..... | 54 |
| Finding National Parks..... | 46 | Routines..... | 54 |
| Finding Ultimate Campgrounds Points of | | Adding a Routine..... | 55 |
| Interest..... | 46 | Editing a Routine..... | 55 |
| Tripadvisor..... | 46 | Deleting a Routine..... | 55 |
| Finding Tripadvisor Points of | | Viewing Weather Information..... | 55 |
| Interest..... | 47 | Driver Awareness Features and | |
| Viewing Recently Found Locations..... | 47 | Alerts..... | 56 |
| Clearing the List of Recently Found | | Enabling or Disabling Driver Alerts..... | 56 |
| Locations..... | 47 | Live Services, Traffic, and | |
| Viewing Current Location | | Smartphone Features..... | 56 |
| Information..... | 47 | Pairing with Your Smartphone..... | 57 |
| Finding Emergency Services and | | Smart Notifications..... | 57 |
| Fuel..... | 47 | Receiving Notifications..... | 57 |
| Getting Directions to Your Current | | Receiving Notifications while | |
| Location..... | 47 | Viewing the Map..... | 58 |
| Adding a Shortcut..... | 47 | Viewing the List of Notifications..... | 58 |
| Removing a Shortcut..... | 48 | Hands-Free Calling..... | 58 |
| Saving Locations..... | 48 | Enabling Hands-Free Calling..... | 58 |
| Saving a Location..... | 48 | | |
| Saving Your Current Location..... | 48 | | |
| Editing a Saved Location..... | 48 | | |

| | | | |
|---|-----------|---|-----------|
| Placing a Call..... | 58 | Viewing E-label Regulatory and Compliance Information..... | 65 |
| Calling Home..... | 59 | Specifications..... | 66 |
| Placing a Call Using Voice Dial..... | 59 | Charging the Device..... | 66 |
| Receiving a Call..... | 59 | Device Maintenance..... | 66 |
| Using In-Call Options..... | 59 | Map and Software Updates..... | 66 |
| Disabling Phone Calls..... | 59 | Updating Maps and Software Using a Wi-Fi Network..... | 67 |
| Disconnecting a Bluetooth Device..... | 59 | Connecting to a Wi-Fi Network..... | 67 |
| Deleting a Bluetooth Device..... | 59 | Updating Maps and Software with Garmin Express..... | 68 |
| Settings..... | 60 | Device Care..... | 69 |
| Dog Tracking Settings..... | 60 | Cleaning the Outer Casing..... | 69 |
| Dog Display Settings..... | 60 | Cleaning the Touchscreen..... | 69 |
| Dog Alerts Settings..... | 60 | Cleaning the USB Port..... | 69 |
| Backing Up and Restoring Dog Data..... | 60 | Restarting the Device..... | 69 |
| Phone Settings..... | 61 | Troubleshooting..... | 70 |
| Wi-Fi Settings..... | 61 | My device is not acquiring satellite signals..... | 70 |
| Map Settings..... | 61 | My device does not connect to my phone..... | 70 |
| Navigation Settings..... | 61 | The device does not charge in my vehicle..... | 70 |
| Traffic Settings..... | 62 | My battery does not stay charged for very long..... | 70 |
| Setting a Simulated Location..... | 62 | My device does not connect to my computer..... | 70 |
| Driver Assistance Settings..... | 62 | Appendix..... | 71 |
| Proximity Alerts Settings..... | 62 | Bare Wire Power Cable..... | 71 |
| Display Settings..... | 62 | Pairing a Tempe Sensor..... | 71 |
| System Settings..... | 63 | | |
| Position Format Settings..... | 63 | | |
| Device and Privacy Settings..... | 63 | | |
| Restoring Settings..... | 63 | | |
| Data Management..... | 63 | | |
| About Memory Cards..... | 63 | | |
| Installing a Memory Card for Maps and Data..... | 64 | | |
| Connecting the Device to Your Computer..... | 64 | | |
| Transferring GPX Files From Your Computer..... | 64 | | |
| Transferring Data From Your Computer..... | 64 | | |
| Adding BaseCamp™ Data to Garmin Explore™..... | 65 | | |
| Exporting Data from BaseCamp with a PC..... | 65 | | |
| Exporting Data from BaseCamp with an Apple Computer..... | 65 | | |
| Importing Data to Garmin Explore.... | 65 | | |
| Device Information..... | 65 | | |

Getting Started

⚠ WARNING

See the *Important Safety and Product Information* guide in the product box for product warnings and other important information.

Setting Up the Alpha System

Before you can use the Alpha system, you must set up the devices.

- 1 Install the Alpha XL navigator in your vehicle (*Installation*, page 3).
- 2 Turn on the Alpha XL navigator (*Turning the Device On or Off*, page 6).
- 3 Pair one or more dog collar devices with the Alpha XL navigator (*Methods to Add a Dog Collar Device to Your Navigator*, page 10).
- 4 If necessary, add one or more contacts to your contact list (*Methods to Add a Contact to the Navigator*, page 21).

Device Overview

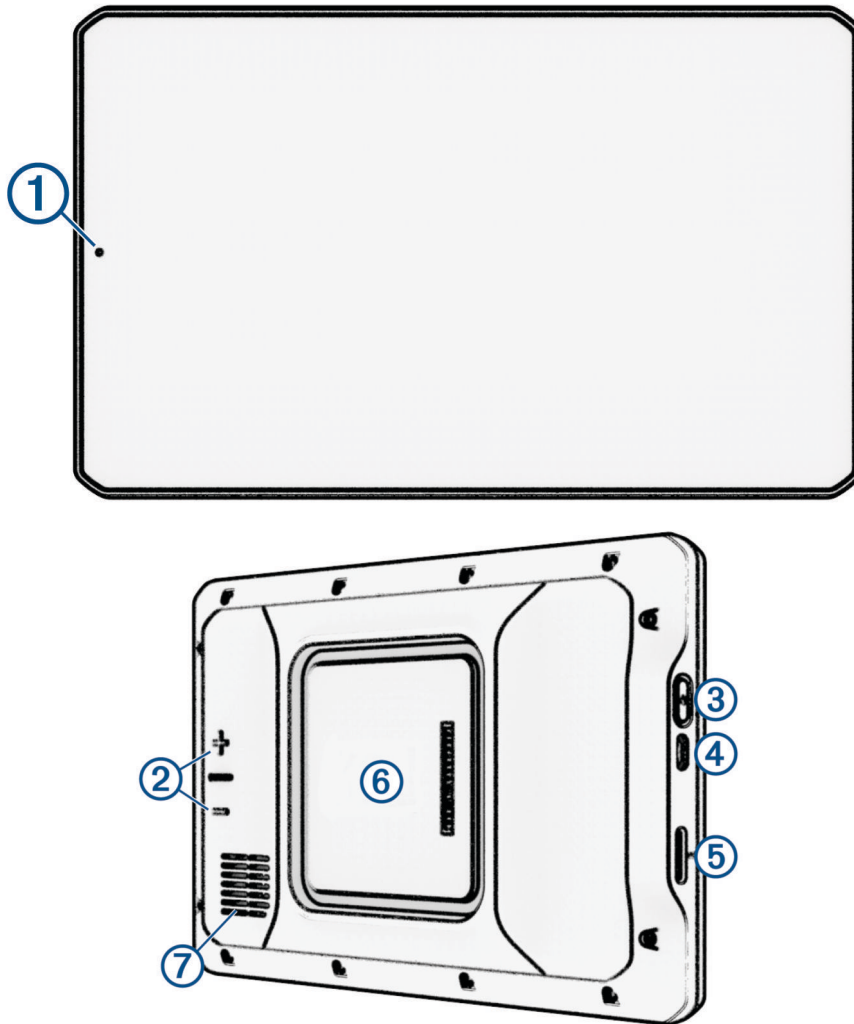

| | |
|---|---|
| ① | Microphone for hands-free calling and voice command |
| ② | Volume control |
| ③ | Power button |
| ④ | USB power and data port |
| ⑤ | Map and data memory card slot |
| ⑥ | Magnetic mount interface with 14-pin connector |
| ⑦ | Speaker |

VHF Radio Information

This product may be used only on specific radio frequencies, which vary depending on the country of use. The navigator and dog collar device allow the user to install a different antenna. Changing the antenna can affect the radio performance and radiated power. You must not use the device with a third party antenna or an antenna not approved by Garmin®. Go to www.garmin.com/tracking-legal for details about the performance and radio frequency of this product, lawful accessories, and power limits for countries.

Installation

Installing the VHF Dock in Your Vehicle

⚠ WARNING

Both the device and its mount contain magnets. Under certain circumstances, magnets may cause interference with some internal medical devices and electronic devices, including pacemakers, insulin pumps, or hard drives in laptop computers. Keep the device away from medical devices and electronic devices.

- 1 Secure the ball adapter ① to the mount ② using the included screws and washers ③.

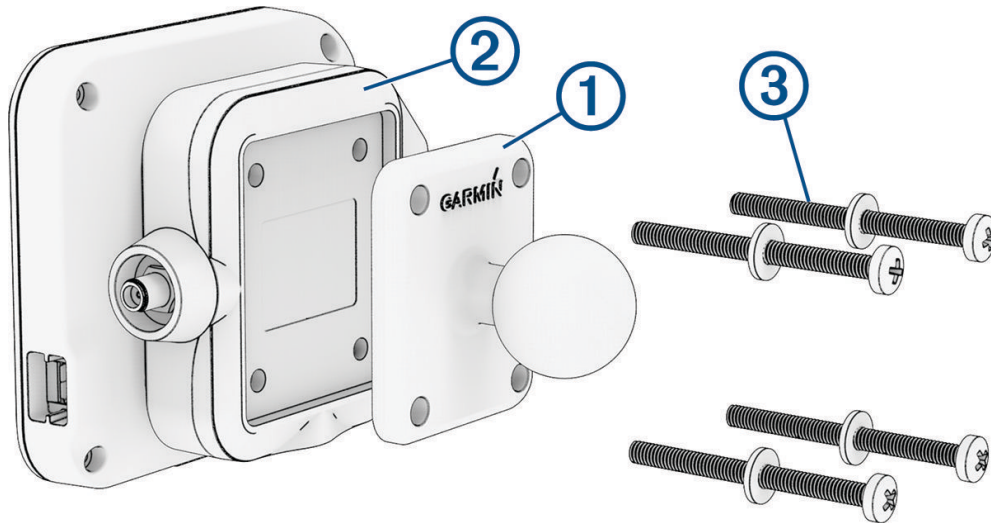

- 2 Connect the ball of the powered magnetic mount ④ and the ball of the suction cup ⑤ to the double-socket arm ⑥.

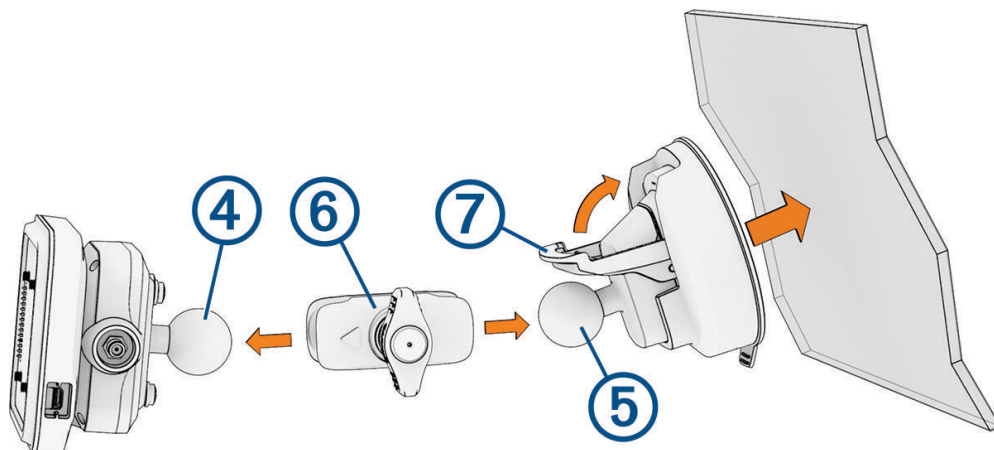

- 3 Tighten the knob on the double-socket arm slightly.
- 4 Clean and dry your windshield and the suction cup with a lint-free cloth.
- 5 Press the suction cup to the windshield, and flip the lever ⑦.
- 6 If necessary, rotate the powered magnetic mount so the Garmin logo faces right-side up, and adjust the mount for better viewing and operation.
- 7 Tighten the knob to secure the mount.

Installing the External VHF Antenna

⚠ WARNING

The external VHF antenna contains a magnet. Under certain circumstances, magnets may cause interference with some internal medical devices and electronic devices, including pacemakers, insulin pumps, or hard drives in laptop computers. Keep the device away from medical devices and electronic devices.

- 1 Connect the angled antenna adapter ① to the antenna port on the magnetic mount.

TIP: You can connect the antenna cable directly to the antenna port if you do not need to change the angle of the cable.

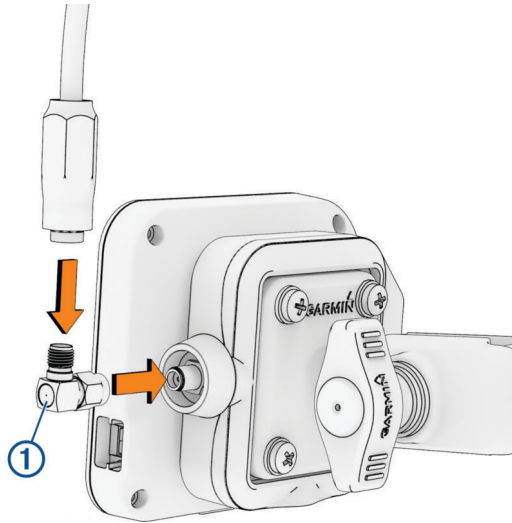

- 2 Connect the cable from the magnetic VHF Antenna to the angled antenna adapter.
- 3 Route the cable through a suitable path in your vehicle.
- 4 Place the magnetic antenna on the roof of your vehicle.

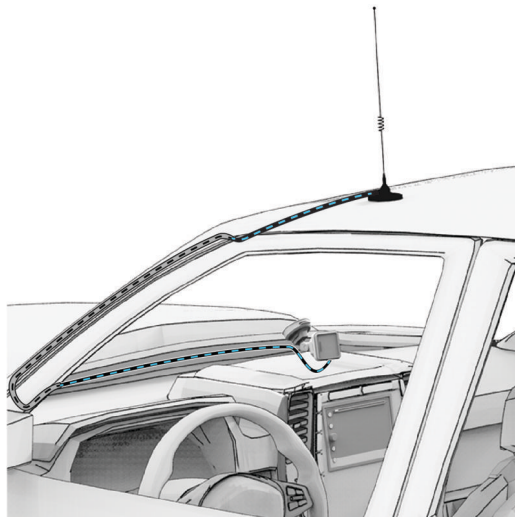

Connecting the Mount and Navigator to Vehicle Power

- 1 Plug the small end of the power adapter cable ① into the port on the side of the powered mount.

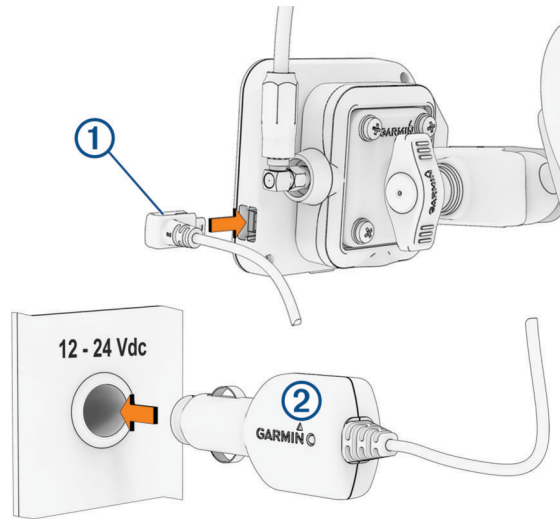

- 2 Plug the vehicle power adapter ② into the power outlet in your vehicle.
- 3 Connect the Alpha XL navigator ③ to the magnetic mount.

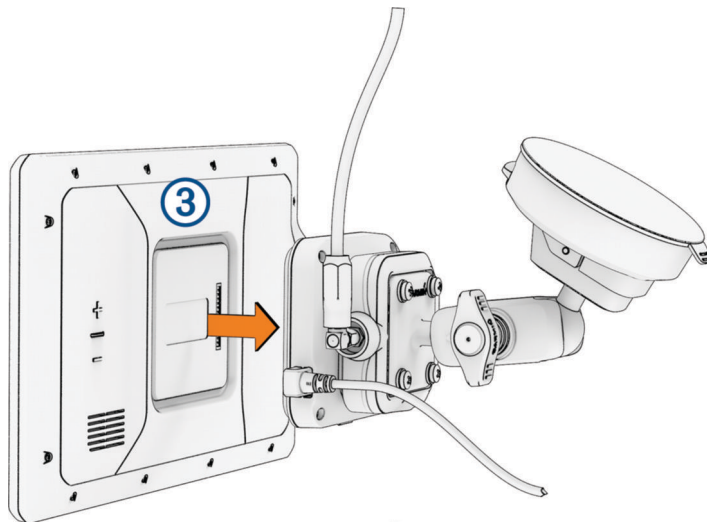

- 4 If necessary, turn on the vehicle ignition switch to provide power to the power outlet in your vehicle.

Turning the Device On or Off

- To turn the device on, press the power button ①, or connect the device to power.

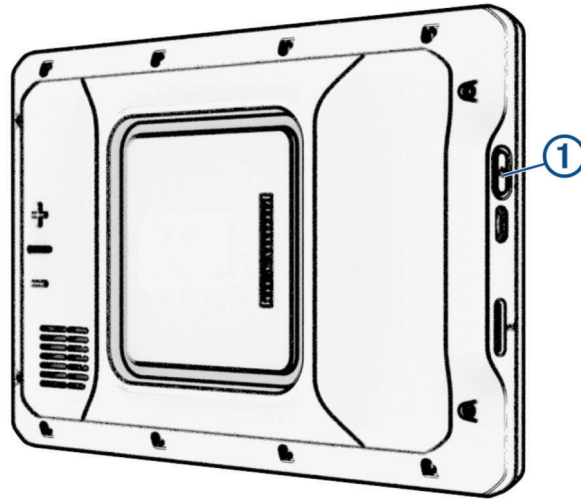

- To put the device in power saving mode, press the power button while the device is on. While in power saving mode, the screen is off and the device uses very little power, but it can wake instantly for use.
TIP: You can charge your device faster by putting it in power saving mode while charging the battery.
- To turn off the device completely, hold the power button until a prompt appears on the screen, and select **Power Off**.
The prompt appears after five seconds. If you release the power button before the prompt appears, the device enters power saving mode.







Main Menu



| | |
|-----------------------|---|
| ① | The status bar (<i>Status Bar Icons</i> , page 8). |
| ② | Select to view the map (<i>Using the Map</i> , page 36). |
| ③ | Select to view the status of all connected dogs and contacts (<i>Pro View</i> , page 16). |
| ④ | Current weather conditions. |
| ⑤ | Shortcuts to dogs, contacts, groups, and notifications. |
| ⑥ | Select to open the training menu (<i>Training Menu</i> , page 19). |
| ⑦ | Select to stop an active route. |
| ⑧ | Select to open the apps menu. The apps menu contains shortcuts to all of the apps available on your device. |
| ⑨ | Select to adjust the volume (<i>Adjusting the Volume</i> , page 9). |
| ⑩ | Select to view device settings and update software (<i>Settings</i> , page 60). |
| Search | Select to search for a location and start navigation (<i>Finding and Saving Locations</i> , page 41). |
| Saved | Select to view saved locations (<i>Viewing Your Saved Items</i> , page 49). |
| Training Setup | Select to configure the training menu (<i>Training Menu</i> , page 19). |
| New Hunt | Select to start a hunt (<i>Starting a Hunt</i> , page 23). |
| Map Manager | Select to add maps or configure the map view (<i>Changing the Map Region</i> , page 40). |

Status Bar Icons

The status bar is located at the top of the main menu. The status bar icons display information about features on the navigator. You can select some icons to change settings or view additional information.

| | |
|---|---|
|  | GPS signal status. Select to view GPS accuracy and acquired satellite information. |
| COMM  | Connection status between the navigator and the magnetic mount. |
|  | Bluetooth® technology status. |
|  | Wi-Fi® signal strength. Select to change the Wi-Fi settings (Wi-Fi Settings, page 61). |
|  | Connected to hands-free calling. Select to place a phone call (Hands-Free Calling, page 58). |
|  | Active vehicle profile. Select to view the vehicle profile settings (Editing a Vehicle Profile, page 27). |
| 9:10 | Current time. Select to set the time (Setting the Time, page 9). |
|  | Battery charge level. |
| 53° F | Temperature. Select to view the weather forecast (Viewing Weather Information, page 55). |

Opening an App

The home screen contains shortcuts for frequently used apps. The app drawer contains all of the apps installed on your device.



Select an option:

- Select an app shortcut from the home screen.
- Select  and select an app.

Acquiring GPS Signals







When you turn on your navigation device, the GPS receiver must collect satellite data and establish the current location. The time required to acquire satellite signals varies based on several factors, including how far you are from the location where you last used your navigation device, whether you have a clear view of the sky, and how long it has been since you last used your navigation device. The first time you turn on your navigation device, it may take several minutes to acquire satellite signals.

- 1 Turn on the device.
- 2 Wait while the device locates satellites.
- 3 If necessary, go to an open area, away from tall buildings and trees.



 in the status bar indicates the satellite signal strength. When at least half the bars are filled, the device is ready for navigation. You can touch the  icon to view more details about your satellite signal, such as your current location accuracy.

Using the On-Screen Buttons

On-screen buttons allow you to navigate the pages, menus, and menu options on your device.

- Select  to return to the previous menu screen.
- Hold  to quickly return to the main menu.
- Select  or  to scroll through lists or menus.
- Hold  or  to scroll faster.
- Select  to see a context-based menu of options for the current screen.

Adjusting the Volume

- 1 Select .
- 2 Select an option:
 - Use the slider bar to adjust the volume.
 - Select  or  to mute or unmute the device volume.
 - If you have paired a phone with your device, touch the volume buttons under the phone name to increase or decrease the phone's volume.
 - Select **Mixer** to individually control volume for sounds such as navigation instructions and proximity alerts.
 - Select a check box to enable or disable additional sound options.

Adjusting the Screen Brightness

- 1 Select  > **Display**.
- 2 Use the slider bar to adjust the brightness.

Changing the Keyboard

Before you can change the keyboard language or layout, you must enable a keyboard language or layout in the system settings ([System Settings, page 63](#)).

- Select  to switch to a different keyboard language or layout.

Setting the Time

- 1 From the main menu, select the time.
- 2 Select an option:
 - To set the time automatically using GPS information, select **Automatic**.
 - To set the time manually, drag the numbers up or down.

Dog Tracking and Training

Dog Collar Device Setup

Methods to Add a Dog Collar Device to Your Navigator

You can add up to 20 devices to one navigator by pairing wirelessly, entering the track and control codes, or by sharing wirelessly using ANT® technology. Up to 20 devices can be active at one time.

Pairing wirelessly: Allows you to add a dog collar device after you have placed the dog collar device into pairing mode by pressing the power button.

This method is helpful when you are adding a new accessory collar to the system prior to leaving for the hunt ([Adding a Dog to the Alpha XL Navigator Using Wireless Pairing, page 10](#)).

Entering the track and control codes: Allows you to add a dog collar device that you do not own and that is not in the area. The dog's owner must determine if you can only track the dog or can track and control the dog. This method requires the dog's owner to find and communicate the codes to the person adding the dog collar device.

This method is helpful when you would like to add a dog collar device during a hunt, but you are not near the dog. For example, you are adding another member of your hunting party's dog collar device to your navigator, but you do not own the dog collar device ([Adding a Dog Using the Track and Control Codes, page 11](#)).

NOTE: This feature varies based on dog collar device type and feature availability in your area. You may see track codes only or track and control codes.

Sharing wirelessly using ANT wireless technology: Allows you to add a dog collar device that you do not own and that is not in the area. The dog's owner must determine if you can only track the dog or can track and train the dog. This method does not require the dog's owner to find and communicate the codes to the person adding the dog collar device. This method also adds dog information, such as the dog's name, communication settings, and initial position, from the sending navigator to your navigator. The two navigators must be within range 3 m (10 ft.) to share data wirelessly.

This method is helpful when you want to add a dog collar device during a hunt, but you are not near the dog. For example, the dogs have already been let loose, and you are near the dog owner, who can share the dog wirelessly ([Sharing a Dog Wirelessly, page 11](#)).

Adding a Dog to the Alpha XL Navigator Using Wireless Pairing

To pair wirelessly, the dog collar device must be within range of the Alpha navigator.

- 1 Hold the power button on the dog collar device until the device emits two series of beeps (about 2 seconds), and then release the power button.

The status LED flashes blue. The dog collar device is now ready to be paired with a navigator.

- 2 On the navigator, select  > .

- 3 Select **Pair Collar**, and follow the on-screen instructions.

- 4 After successfully adding the dog collar device, enter the name of the dog, and select **Done**.

- 5 Select a beacon color for this dog collar device, and select **Done**.

Adding a Dog Using the Track and Control Codes

NOTE: This feature varies based on dog collar device type and feature availability in your area.

Before you can add a dog using the track and control codes, the dog owner must find the track and control codes ([Finding the Dog ID and Track and Control Codes, page 11](#)) and tell them to you.

You can use track and control codes to authorize a handheld device to interact with your dog collar device. If you are not near the dog you want to add or you cannot put the collar into pairing mode, you can add the dog using the track and control codes.

1 Select  > .

2 Select **Enter Track or Control Code**.

3 Enter the track or control code for the collar, and select **Done**.

The dog's track code allows you to track the dog. The dog's control code allows you to both track and train the dog.

4 Enter the name of the dog, and select **Done**.

Finding the Dog ID and Track and Control Codes

You can share a dog's track code so another person can track your dog. Also, you can share a dog's control code so another person can track and train your dog.

1 From the main menu, select .

2 Select the dog to share.

3 Select .

The ID, the track code, and the control code are displayed at the top of the page.

Adding a Dog Wirelessly From Another Navigator

Before you can receive a dog wirelessly from another navigator, the dog owner must share their dog wirelessly.

Select  >  > **Receive From Device**.

Sharing a Dog Wirelessly

Before you can share data wirelessly over ANT, you must bring your Alpha navigator within 3 m (10 ft.) of the other navigator.

1 From the main menu, select .

2 Select the dog to share.

3 Select  > **Share Wirelessly**.







4 Select an option:

- To allow the other person to track your dog's location with the map and dog tracking compass, select **Track Only**.
- To allow the other person to track your dog and correct your dog's behavior, select **Track and Control**.

To successfully share the dog collar device, the other navigator must be receiving the device information ([Adding a Dog Wirelessly From Another Navigator, page 11](#)).

Managing a Group

Before you can create a group, you must add one or more dog devices or contacts to your navigator.

- 1 From the main menu, select .
- 2 If necessary, select  to add a group, and enter a group name.
- 3 Select a group from the list.
- 4 Select an option:
 - To add a device to the group, select  > **Add to Group**, and select one or more dogs or contacts.
 - To activate dogs or contacts in the group, select each dog or contact to set them as active.
 - To deactivate dogs or contacts in the group, clear the check box next to each dog or contact.
 - To remove a dog or contact from the group, select , and select a dog or contact.
 - To rename the group, select  > **Rename Group**, and enter a new name.
 - To delete the group, select  > **Delete Group**.

Editing Dog Information

Changing the Dog Name

- 1 From the main menu, select .
- 2 Select a dog.
- 3 Select **Rename**.
- 4 Enter the name, and select **Done**.



Changing the Color of the Dog's Track

You can change the track color of the dog. It is helpful to have the track color match the color of the collar strap, if possible.



- 1 From the main menu, select .
- 2 Select a dog.
- 3 Select **Set Color**.
- 4 Select a color.

Changing the Dog Type

Before you can change the dog type, the collar must be turned on and within range of the navigator.

- 1 From the main menu, select .
- 2 Select a dog.
- 3 Select  > **Collar Settings** > **Change Dog Type**.
- 4 Select a dog type.

Removing a Dog

- 1 From the main menu, select .
- 2 Select a dog.
- 3 Select  > **Remove**.

Fitting the Collar on Your Dog

⚠ CAUTION

To prevent irritation from the contact points, remove the collar for at least eight hours out of every 24-hour period.

This device is not intended for human use. Do not attempt to use on any person.

Do not spray the device or collar with harsh chemicals including but not limited to flea or tick spray. Always ensure that any flea or tick spray that is applied to the dog is completely dry before placing the collar on the dog. Small amounts of harsh chemicals can damage the plastic components and collar strap.

Before you can put the collar on the dog, you must pair the navigator and dog collar device ([Methods to Add a Dog Collar Device to Your Navigator, page 10](#)), and acquire satellite signals ([Acquiring GPS Signals, page 8](#)).

In order to effectively train the dog, the collar must fit the dog properly. If the collar is too loose or positioned incorrectly, stimulation may be inconsistent. This can delay or prevent successful training.

- 1 Position the collar with the communication antenna pointing up, the GPS antenna facing up, the LEDs facing forward, and the contact points against the neck.
- 2 Place the collar around the middle of the dog's neck.
- 3 Tighten the strap so that it is snug around the dog's neck, and fasten the buckle.

NOTE: The collar should fit tightly and should not be able to rotate or slide on the dog's neck. The dog must be able to swallow food and water normally. You should observe your dog's behavior to verify that the collar is not too tight.

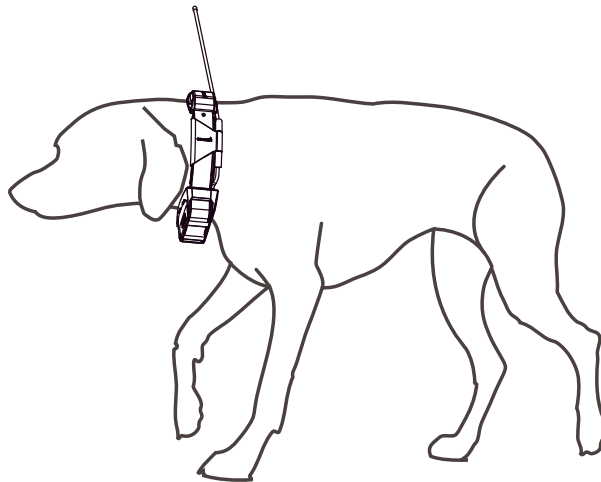

- 4 Wiggle the device to work the contact points through the dog's coat.
NOTE: The contact points must have contact with the dog's skin to be effective.
- 5 If the strap is too long, cut off the excess, leaving at least 7.62 cm (3 in.) to spare.
TIP: You can mark the hole used to fasten the buckle for future reference.

Communication with the Dog Collar Device

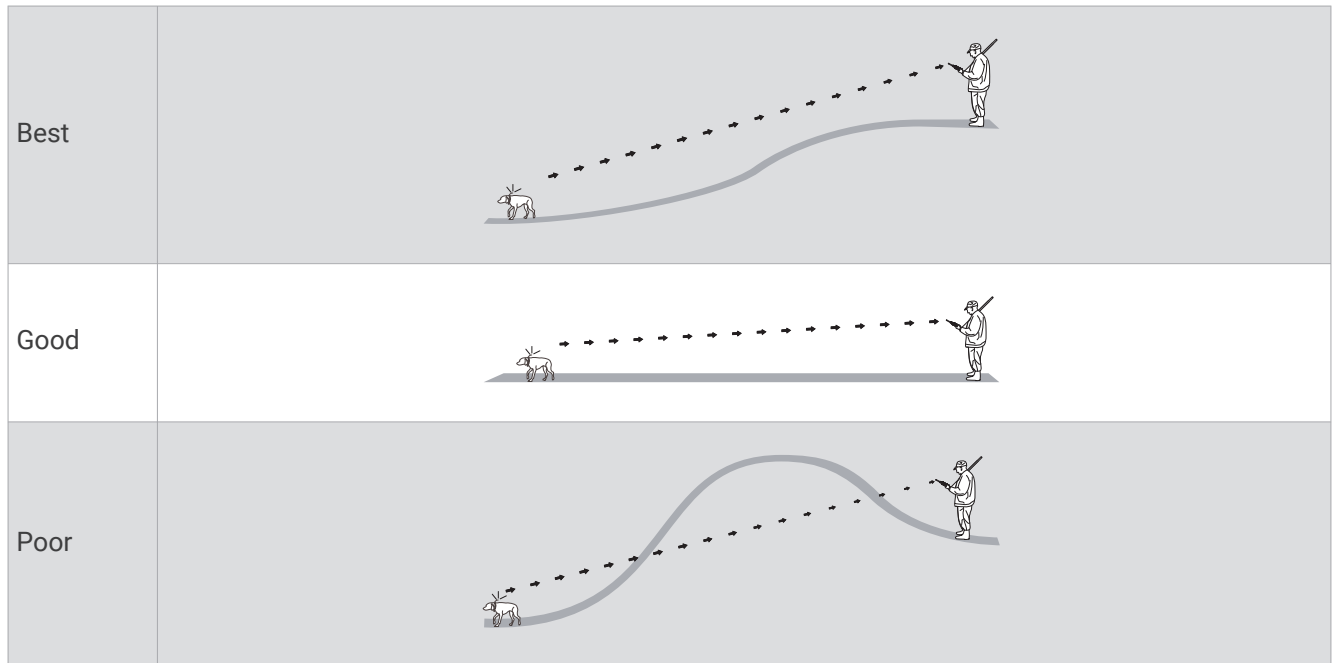

You should keep an unobstructed line of sight between your navigator and dog collar device to produce the best communication signal. To achieve the best line-of-sight conditions, you should move to the highest elevation point in your area (for example, on the top of a hill).



Using a Dynamic Update Rate

When you are actively tracking your dog, the dog collar device can use a dynamic update rate to help conserve battery power based on the activity of your dog.

NOTE: This feature is not available in all areas.

- 1 From the main menu, select .
- 2 Select a dog.
- 3 Select  > **Update Rate** > **Dynamic**.

Using Sleep Mode

Before you can enter sleep mode, you must track your dog's location using the compatible dog collar device.

When paired with a navigator, the dog collar device can be put into sleep mode to conserve the battery when you are not actively tracking your dog.

- 1 From the main menu, select .
- 2 Select a dog.
- 3 Select **Sleep Mode**.
- 4 Select an option:
 - Select **Enable Sleep Mode** to enter sleep mode.
 - Select **Wake Collar** to exit sleep mode.

Channel View

Alpha navigators and dog collar devices broadcast data over individual channels. Channels are identified using unique IDs. You can use the channel view to see which channels are in use and which channels are available.

Changing the Dog ID

Before you can change the dog ID, the collar must be turned on and within range of the navigator.

If you are experiencing interference from other collars or navigators in the area, you might need to change the ID for the dog.

1 Select  > **Channel View** > **My Devices**.

2 Select a dog, and select **Yes**.

The navigator scans for an ID free of interference and selects it automatically.

TIP: If necessary, you can select Choose an ID to select an available ID.

If another handheld device is tracking this dog, for best results, remove the dog from the device, and use the track and control codes to add the dog again ([Adding a Dog Using the Track and Control Codes, page 11](#)).

Tracking Your Dog on the Map

Before you can track a dog on the map, you must add it to the navigator ([Methods to Add a Dog Collar Device to Your Navigator, page 10](#)).





You can view the dog's location on the map.

1 From the home screen, select **View Map**.

2 If necessary, select  and  to zoom in and out of the map.

TIP: You can select  from the training menu to view the status, distance, and direction of your dogs and contacts.

Dog Status Icons

| | |
|---|----------------------|
|  | Sitting |
|  | Running |
|  | On point |
|  | Treed |
|  | Unknown ¹ |

¹ The unknown status icon indicates that the navigator cannot communicate with the dog collar device.

Pro View

From the main menu, select **Pro View**.

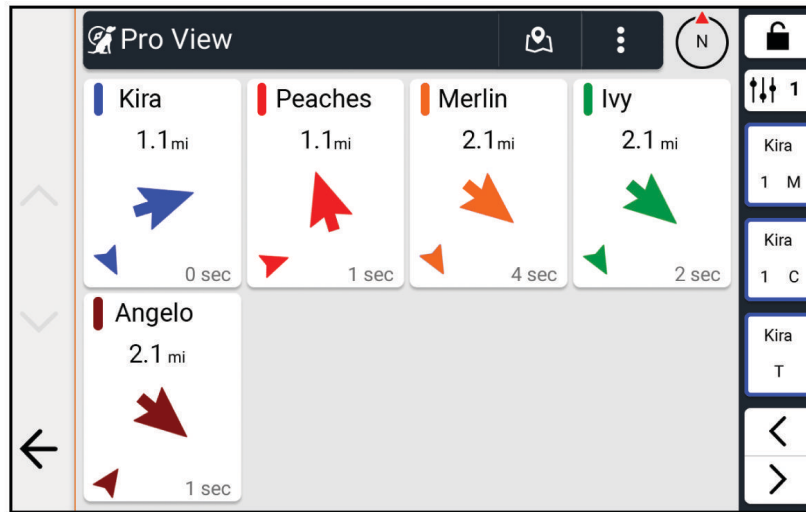

You can use the pro view feature to view the direction and distance to your dog and any paired devices. The pro view feature also shows the dog's status, such as running or on point ([Dog Status Icons](#), page 15). The color of each pointer corresponds to the color of the track on the map.

The direction and distance are most accurate when the dog or paired device is more than 9.1 m (30 ft.) away. When the dog or paired device is less than 9.1 m (30 ft.) away, "Near" appears.

Navigating to Your Dog

- 1 From the main menu, select **Pro View**.
- 2 Select the dog.
- 3 If necessary, select  to view the dog's location and direction.
- 4 Select **Go!**.

Changing the Length of the Dog's Track

You can adjust the length of time the dog track appears on the map. Reducing the duration of the track can reduce the clutter on the map. Changing the map does not affect the tracks stored in the navigator.



- 1 From the home screen, select  > **Dog Tracking** > **Dog Tracks on Map**.
- 2 Select a time frame.

Location Alerts

Location alerts notify you when your dogs enter or exit a particular location. You can create a custom geofence or use a radius around your current location.

A geofence is an invisible boundary around an area and is created using points on the map. The virtual boundaries of a geofence are accurate up to approximately 3 m (10 ft.).



Setting Location Alerts

- 1 Select  > **Location Alerts** > .
- 2 Select an option:
 - To create a geofence alert, select **Geofence**, and touch the map to select points that define the geofence boundary.
You must select at least 3 points to create a geofence alert.
 - To create a radius alert, select a radius option, and enter the radius distance.

Enabling or Disabling Location Alerts

- 1 Select  > **Location Alerts**.
- 2 Select an option:
 - To disable a location alert, clear the checkbox next to the alert.
 - To enable a location alert, select the checkbox next to the alert.

Editing Location Alerts

- 1 Select  > **Location Alerts**.
- 2 Select an alert.
- 3 Select an option:
 - Select **Set Alert Type** to set the way the device notifies you for this alert.
 - Select **Set Alert Mode** to set the notification to sound on exit, entrance, or both.
 - Select  to remove the alert.

Dog Training

NOTICE

You should research and investigate the training methods best suited for you, your dog, and your needs. This manual provides some basic guidelines for training, but each dog has unique training needs.

When used properly, the Alpha training system is a very effective training tool to aid your dog in reaching its full potential. The use of the training system should be part of an overall training program.

Begin training your dog on a leash, without the Alpha training system. You should train your dog how to heel, sit, and come to you. After the dog understands these three basic commands, you can begin training with the dog collar device and the leash. Finally, when the dog consistently obeys commands using the leash and collar, you may be able to remove the leash to train with only the dog collar device.

Selecting and Installing the Contact Points

CAUTION

To prevent irritation from the contact points, remove the collar for at least eight hours out of every 24-hour period.

Do not spray the device or collar with harsh chemicals including but not limited to flea or tick spray. Always ensure that any flea or tick spray that is applied to the dog is completely dry before placing the collar on the dog. Small amounts of harsh chemicals can damage the plastic components and collar strap.

For best results, select the correct contact points based on your dog's coat.

- 1 Select the correct contact point length for your dog's coat type:
 - For dogs with thicker coats, use the longer contact points.
 - For dogs with shorter coats, use the shorter contact points.
- 2 If necessary, use the included wrench to remove the contact points.
- 3 Twist the contact points into the collar.
- 4 Tighten with the included wrench, but do not overtighten.

When you put the collar on the dog, make sure the contact points are tight against the neck.

Removing the Contact Points

When you are not training the dog using the training buttons, remove the contact points.

Use the included wrench to remove both contact points.

Collar Training

Begin training your dog on a leash, without using the Alpha training system. After the dog shows a grasp of the commands "heel," "sit," and "here," you can begin training with the collar and the leash.

During the initial stage of collar introduction, the dog learns that collar stimulation means the same thing as a tug on the leash. At first, the dog may be alarmed by the electronic stimulation. The key is to be patient and consistent and not to start off at too high of an intensity. Be fair and consistent, and use repetition and praise when using the collar as a training tool.

If the dog does not respond to the stimulation level you have selected (*Choosing the Correct Intensity Level, page 18*), increase the stimulation one level at a time until you achieve the appropriate response. After you achieve the desired response, you can lower the stimulation level as long as the dog maintains consistency.

As the dog becomes more proficient with the commands, you can begin to introduce distractions, such as rolling a ball in front of the dog or walking him in the presence of others.

After the dog begins to respond consistently to the command during collar training, you can remove the leash and train with just the collar.

NOTE: You should train without a leash only when it is appropriate for your environment and your dog's temperament. You should follow all laws and regulations for your area regarding the use of dog leashes.

Eventually in most training situations, your commands will not require stimulation to be given with the command. You should only use stimulation when you need to repeat a command because the dog did not obey the first one.

As the dog becomes better trained, you can decrease the use of collar training. Continue to have the dog wear the collar until you feel certain that it is no longer needed to reinforce known commands. Abandoning the collar too early can lead to problems in the future.

Training Methods

Momentary stimulation: Applies a brief stimulation when you press the training button, regardless of how long the button is depressed.

Continuous stimulation: Applies stimulation to the dog the entire time you press the training button, for a maximum of 8 seconds. Your stimulations should typically be much shorter than 8 seconds.

Tone: Activates an audible tone the entire time you press the training button.

Vibration: Applies vibration to the dog the entire time you press the training button, for a maximum of 8 seconds. The effectiveness of vibration may vary based on the dog's temperament and experience.

Linear and Traditional Stimulation

You can use linear or traditional stimulation to customize your training experience. The default intensity method is linear, which allows progressive stimulation from level 1 to level 18. Traditional stimulation allows you to make quick changes using low, medium, and high settings within predetermined stimulation levels (1 through 6).

Choosing the Correct Intensity Level

- 1 Set the intensity to the lowest level (*Changing the Intensity Level, page 20*).
- 2 Observe the dog for a reaction, such as a head shake, neck movement, or just a change in expression. Sometimes dogs will vocalize due to the surprise of the electrical stimulation. If the dog vocalizes more than once, the intensity level is too high for beginning training.
- 3 If there is no reaction, increase the intensity level by one level until the dog has a slight but recognizable reaction to the stimulation.

The intensity level that causes a slight but recognizable reaction is your dog's baseline level for beginning collar training. You do not need to, and should not, apply this intensity selection test again.

After you begin training, the dog's performance guides your intensity selection. As the dog advances in training, you may need to change the level depending upon the training situation.

Training Menu

The training menu ① contains shortcuts to training commands, applications, device actions, and utilities. You can customize the training menu pages to best suit your tracking and training needs. You can select 🐕 to open the training menu from any page.



Moving the Training Menu Button

If necessary, you can move the training button to another area on the screen.

- 1 Hold 🐕.
Possible button positions appear on the screen.
- 2 Drag the button to a new position.

Customizing the Training Buttons

You can assign an application shortcut, device action, or utility to a training button. If a compatible dog collar device is paired, you can also add a dog training command to a training button. You can add multiple pages of training buttons. For example, this is useful when training multiple dogs.





NOTE: Training features are not available with all dog collar device models.

- 1 Select **Training Setup**.
- 2 Select **Add** from the empty button you are customizing.
- 3 Select an option:
 - To add a dog training command to the training button, select **Training Command**, select the name of the dog to command, and select a training method.
 - To add an application to the training button, select **Applications**, and select an application.
 - To add a device action to the training button, select **Device Actions**, select an action, and if necessary, select a dog or group to complete the command setup.
 - To add a utility to the training button, select **Utilities**, and select a utility.
- 4 If selecting a dog training command, select momentary (**M**), continuous (**C**), tone (**T**), vibration (**V**), or light (**L**).
- 5 If selecting a dog training command, select **—** or **+** to choose the intensity level.
- 6 If you are using traditional stimulation mode, select **LOW**, **MED**, or **HI**.

TIP: If you want to customize more than three buttons, you can add another page of training button commands.







Using the Training Menu

Before you can use this feature, you must customize your training buttons with dog training commands ([Customizing the Training Buttons, page 19](#)).

- 1 From any screen, select  to open the training menu.
- 2 If necessary, select  or  to move through training pages.
- 3 Select an option:
 - To activate a training command, application, device action, or utility, select a button.
 - To change training command functions, select , and select a training command.
 - To lock the training menu and prevent accidental touches, select .

Changing the Intensity Level

Before you can use this feature, you must customize your training buttons with dog training commands ([Customizing the Training Buttons, page 19](#)).

- 1 From any screen, select  to open the training menu.
- 2 If necessary, select  or  to move through training pages.
- 3 Select , and select a training command.
- 4 Select  or  to choose the intensity level.

Dog Training Options

Select **Training Setup** > .

Training Menu Position: Sets the position of the training menu on the left or right side of the screen.

NOTE: The training menu position can be adjusted only for the landscape screen orientation.

Training Defaults: Sets the default buttons and layout for new training collars ([Default Training Settings, page 20](#)).

Stimulation: Sets the stimulation type ([Linear and Traditional Stimulation, page 18](#)).

Adjust Stim Each Use: Enables the option to adjust the stim level after each use.

Play Tone on Training Command: Enables a tone to play each time you use a training command.

Default Training Settings

From the main menu, select **Training Setup** >  > **Training Defaults**.

Add When Paired: Automatically sets default training modes for each button when a new dog collar is paired.

Button Layout: Sets the number of training buttons for each dog.

Training Button 1: Sets the default training mode for the first training button.

Training Button 2: Sets the default training mode for the second training button.



Training Button 3: Sets the default training mode for the third training button.

Contact Tracking

You can track other hunters so you know where they are at all times. You can also send messages to your contacts. One Alpha XL navigator can track up to 20 devices, including compatible dog collar devices and handheld devices.

Turning On and Off the Transmitter

Before you can add a contact or initiate an emergency alert, you must ensure the transmitter is enabled.

- 1 From the main menu, select .
- 2 Select , and select the **Transmitting** option.

Methods to Add a Contact to the Navigator

Entering the device ID: Allows you to add a contact that is not in the area. This method requires the contact to find and communicate their device ID to the person adding the device contact.

This method is helpful when you would like to add a contact during a hunt, but you are not near the device. For example, if you are adding another member of your hunting party to your navigator, but you do not own the device ([Adding a Contact Using a Contact ID, page 21](#)).



Receiving wirelessly: Allows you to add a navigator that you do not own as a contact. This method does require the contact to share their device wirelessly. The two navigators must be within a range of 3 m (10 ft.) to share data wirelessly.

This method is helpful when you want to add a navigator during a hunt without entering the device ID ([Adding a Contact Wirelessly From Another Navigator, page 21](#)).

Adding a Contact Using a Contact ID

Before you can add a hunter using a contact ID, the hunter must find the contact ID ([Finding Your Contact ID, page 21](#)) and send it to you.

If you are not near the hunter you want to add, you can add the hunter using a contact ID.

- 1 From the main menu, select  >  > **Enter ID**.
- 2 Select a contact ID.
- 3 Enter the name of the contact, and select **Done**.

The contact is added to your navigator

You can repeat this procedure using another hunter's navigator to add your contact ID to that device.



Adding a Contact Wirelessly From Another Navigator

Before you can receive a contact wirelessly from another navigator, the contact must share their contact information.

From the main menu, select  >  > **Receive From Device**.

Sharing a Dog Wirelessly

Before you can share data wirelessly, you must bring your Alpha navigator within 3 m (10 ft.) of the other navigator.

- 1 From the main menu, select .
- 2 Select a contact.
- 3 Select .

To successfully share your contact information, the other navigator must be receiving the contact information ([Adding a Contact Wirelessly From Another Navigator, page 21](#)).



Finding Your Contact ID

From the main menu, select  > .

The contact ID for your navigator is listed under the ID option.

Changing Your Contact ID



If you are experiencing interference from other collars or handheld devices in the area, you might need to change the contact ID for your navigator.

- 1 From the main menu, select  >  > **ID**.
- 2 Select a contact ID.

Each time a contact changes their contact ID, you must update the contact ID in your navigator ([Updating a Contact ID, page 22](#)).

Updating a Contact ID

If a contact has changed their contact ID, you can quickly update the contact ID in your navigator.

- 1 From the main menu, select .
- 2 Select the contact.
- 3 Select  > **Update ID**.
- 4 Select the contact ID that matches the contact's new contact ID.

Tracking a Contact

You can keep track of contacts' locations using the map.

Select **View Map**.

Initiating an Emergency Alert

WARNING

The device allows you to send an emergency message to your paired contacts. This is a supplemental feature and should not be relied upon as a primary method to obtain emergency assistance. The emergency alert feature does not contact emergency services on your behalf.

Before you can initiate an emergency alert, you must turn on the transmitter ([Turning On and Off the Transmitter, page 20](#)).

Before someone can receive your emergency alert, someone must add you as a contact ([Methods to Add a Contact to the Navigator, page 21](#)) and their compatible Alpha navigator must be in VHF range.

You can use an emergency alert when you need immediate assistance and you are away from your group.

From the main menu, select  >  > **Emergency**.



When your contact accepts your emergency alert request, the device displays a message indicating that your contact has started navigating to your location.

After receiving the alert, your contacts can navigate to your location.

Sending a Message to Your Contacts

Before you can send a message to your contacts, you must turn on the transmitter ([Turning On and Off the Transmitter, page 20](#)).

You can send and receive automated messages. There are 18 messages you can choose from, such as "Help" and "I'm Coming."

- 1 From the main menu, select  > .
- 2 Select a message.

The message is sent to your contacts with your name before the message. Anyone tracking your navigator receives the message.

Hunting with the Alpha System

You can perform various tasks that can be helpful when you are hunting with the Alpha system.

- Start a hunt and mark your starting location ([Starting a Hunt, page 23](#)).
- Track your dogs ([Tracking Your Dog on the Map, page 15](#)).
- Track your fellow hunters ([Contact Tracking, page 20](#)).
- View your active hunt metrics ([Active Hunt Metrics, page 23](#)).
- Send messages to your fellow hunters ([Sending a Message to Your Contacts, page 22](#)).
- Turn on the collar light ([Turning On the Collar Light, page 23](#)).
- Put the collar into rescue mode to save battery power ([Turning On Rescue Mode, page 23](#)).

Starting a Hunt

When you start a hunt, the navigator records your dog's hunt statistics and tracks from your starting location.

- 1 From the main menu, select **New Hunt**.
- 2 Select an option:
 - To change which dog collar devices or contacts you are tracking, select **Tracked Devices**, and select the devices you want to track.
 - To clear tracks and statistics from a previous hunt, select **Clear Tracks and Statistics**.
 - To save your starting location as a waypoint, select **Save Current Location**.
- 3 Select **Start**.

Active Hunt Metrics

You can select **Hunt** from the main menu to view the active hunt metrics. The active hunt metrics page displays the active hunt time and distance traveled for your navigator and each paired dog collar device. It also shows the dog status, such as on point, treed, or barking, if available. When you select **End Hunt**, the hunt timer and distance traveled stop recording.

Turning On the Collar Light

You can turn on the LEDs on the collar at night to help locate a dog or to warn drivers if a dog wanders near a road. The light is visible for up to 92 m (100 yd.).

- 1 From the main menu, select .
 - 2 Select a dog.
 - 3 Select an option:
 - To adjust the blink mode, select **Blink Mode**.
 - To select a beacon color, select **Beacon Color**.
- TIP:** Select a different light setting for each dog to help you identify the dogs in the field.

Turning On Rescue Mode

You can turn on rescue mode to conserve battery power at the end of a long hunt or if your dog might get out of range.

- 1 From the main menu, select  to open the dog list.
- 2 Select a dog.
- 3 Select **Rescue Mode > Enable Rescue Mode**.

After you have turned on rescue mode, it stays on until you turn it off.

When the collar battery power falls below 25%, the collar data updates only once every 2 minutes.

Off-Road Navigation Features

Adventurous Routing

Garmin Adventurous Routing™ is a special route calculation mode designed to prefer routes featuring more hills and winding roads. You can choose a level of adventurous routing to fine-tune the route calculation to your preferences. If you prefer winding roads and hills even if it increases travel time, distance or fuel consumption, choose a higher level of adventurous routing.

For each vehicle profile, you can select a level of adventurous routing as the default route calculation mode ([Editing a Vehicle Profile, page 27](#)). Regardless of the current vehicle profile, you can always select  to use adventurous routing when starting, planning, or editing a route.

Adventure Roads and Trails

⚠ WARNING

Entering your vehicle profile characteristics does not guarantee that your vehicle's characteristics will be accounted for in all route suggestions. Limitations may exist in map data for some route suggestions. Always defer to all posted road signs and conditions during vehicle operation. Failure to do so could lead to an accident involving personal injury or death.

This device can navigate off-highway roads and trails based on your vehicle profile. Trails ① are color coded based on accessibility. You can select  to set which adventure roads and trails appear on the map.

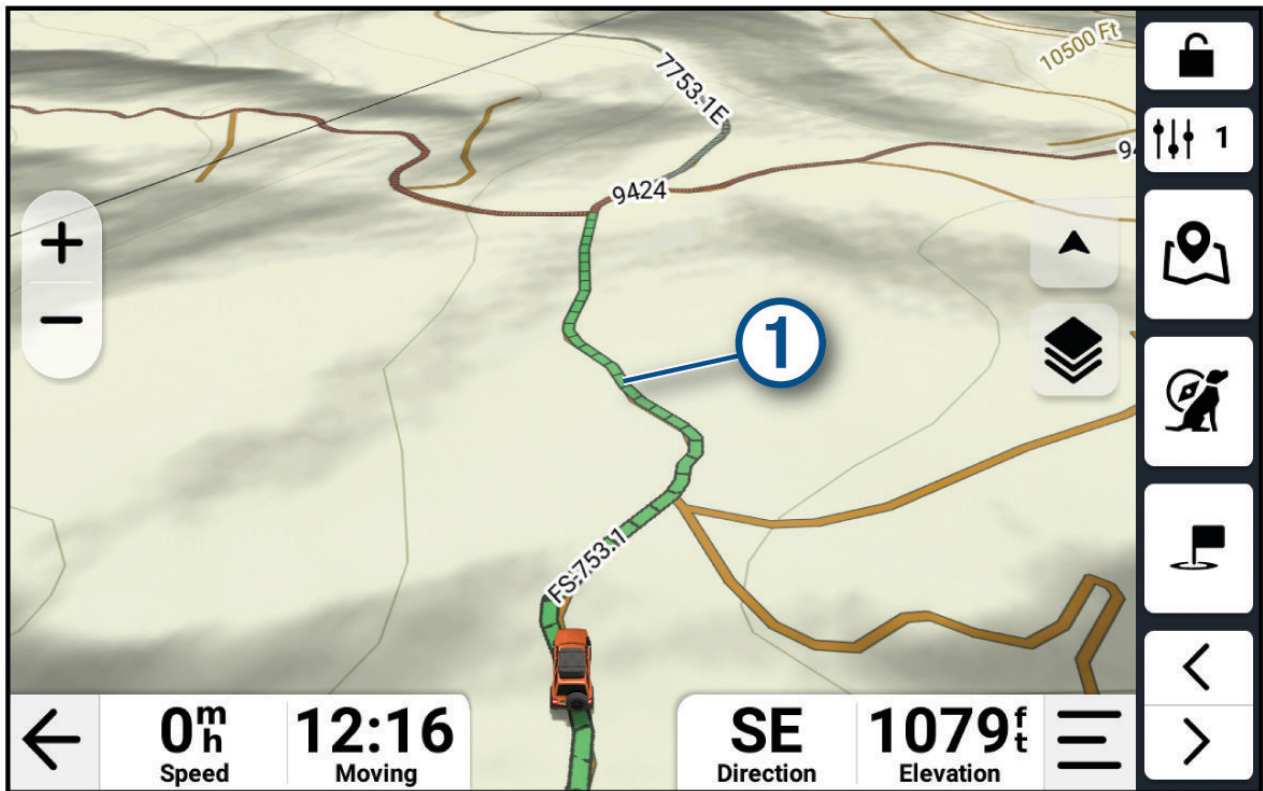

Pitch and Roll

⚠ WARNING

The Pitch and Roll application is intended to show vehicle angles based on calibrated measurements only. You are responsible for calibrating the device. Changes to the position of the device after calibration may affect the accuracy of its measurements. Measured values are suggestions only based on your input into the device. Take readings often and carefully, and allow the readings to stabilize after significant changes in environmental conditions. Always allow a margin of safety for changing conditions and reading errors. Failure to account for your vehicle and your environment could cause an incident resulting in death or serious injury.

The device alerts you if your vehicle pitches or rolls at an angle that could affect the vehicle's stability.

Calibrating Pitch and Roll

You can set the angle of your vehicle to zero at any time.

- 1 Park your vehicle on a flat, level surface.
- 2 Adjust the position of your device in the mount so you can comfortably view the screen.
- 3 Select  > **Pitch and Roll** > **Calibrate**.



The values for pitch and roll reset to 0 degrees.

WARNING



To maintain the best accuracy, you must calibrate pitch and roll each time you reposition your device.

Adjusting Warning Angles

You can adjust the angles at which the device activates a pitch or roll alert. You are responsible for knowing and setting the correct pitch and roll angle for your vehicle.

- 1 Select  > **Pitch and Roll** > .
- 2 Swipe up or down to adjust the pitch or roll warning angles.
- 3 Select **OK**.

Enabling or Disabling Warning Angle Alerts

- 1 Select  > **Pitch and Roll** > .
- 2 Select an option:
 - To enable or disable pitch and roll notifications, select **Pitch and Roll Notifications**.
 - To enable or disable audible alerts, select **Audible Alerts**.

Viewing the Altimeter, Barometer, and Compass

The device contains internal altimeter, barometer, and compass sensors with automatic calibration.

Select  > **ABC**.

Calibrating the Compass



NOTICE

Calibrate the electronic compass outdoors. To improve heading accuracy, do not stand near metal objects or objects that influence magnetic fields, such as vehicles, electronic devices, buildings, or overhead power lines.

When your device is connected to the mount, it uses GPS data to determine your compass heading. When you remove the device from the mount, it uses a built-in compass to show your heading.

Each time you disconnect your device from the mount, you may need to calibrate the compass.

If you experience irregular compass behavior, for example, after moving long distances or after extreme temperature changes, you can manually calibrate the compass to improve accuracy.

- 1 Disconnect the device from the mount and move away from objects that influence magnetic fields.
- 2 From the main menu, select  > **ABC** >  > **Calibrate Compass**.
- 3 Follow the on-screen instructions.

inReach® Remote

The inReach remote function allows you to control your inReach satellite communication device (sold separately) using your Alpha XL device. You can send messages, view weather reports, trigger an SOS alert, and more. Go to buy.garmin.com to purchase an inReach device.

Connecting an inReach Device

- 1 Bring the inReach device within 3 m (10 ft.) of your Alpha XL device.
- 2 On your Alpha XL device, select  > **inReach**.
- 3 Follow the on-screen instructions on your Alpha XL device to complete the pairing process.

After the pairing process is complete, the inReach and Alpha XL devices connect automatically when they are within range.

Sending a Text Message

- 1 Select **inReach** > **Compose**.
- 2 Select one or more contacts, and select **Done**.
- 3 Enter a message.
- 4 Select **Send**.

SOS

WARNING

Before you can use the SOS function, you must have an active satellite subscription. Always test your device before you use it outdoors.

Ensure you have a clear view of the sky when using the SOS function, because this feature requires satellite access to operate properly.

NOTICE

Some jurisdictions regulate or prohibit the use of satellite communications devices. It is the responsibility of the user to know and follow all applicable laws in the jurisdictions where the device is intended to be used.



During an emergency, you can use your paired inReach satellite communicator to contact the Garmin ResponseSM center to request help. The SOS feature sends a message to the Garmin Response team, and they notify the appropriate emergency responders of your situation. You can communicate with the Garmin Response team during your emergency while you wait for help to arrive. You should only use the SOS function in a real emergency situation.

Initiating an SOS Rescue

Before you can initiate an SOS rescue using your Alpha XL device, you must pair it with a compatible inReach device ([Connecting an inReach Device](#), page 26).

NOTICE

While the device is in SOS mode, do not turn off or attempt to turn off the inReach device. Doing so could prevent this feature from operating properly and could delay receipt of assistance in the event of an emergency.

- 1 Select  > **inReach**.
- 2 Select .
- 3 Wait for the SOS countdown.
- 4 Reply to the confirmation message from the emergency response service.

The device sends a default message to the emergency response service with details about your location.

Your reply lets the emergency response service know that you are capable of interacting with them during the rescue.

For the first 10 minutes of your rescue, an updated location is sent to the emergency response service every minute. To conserve battery power after the first 10 minutes, an updated location is sent every 10 minutes when moving, and every 30 minutes when stationary.

Canceling an SOS Rescue

If you no longer need assistance, you can cancel an SOS rescue after it is sent to the emergency response service.

Select **Cancel SOS > Cancel SOS**.

Your device transmits the cancellation request. When you receive a confirmation message from the emergency response service, the device returns to normal operation.

Vehicle Profiles

WARNING



Entering your vehicle profile characteristics does not guarantee that your vehicle's characteristics will be accounted for in all route suggestions or that you will receive the warning icons in all cases. Limitations may exist in the map data such that your device cannot account for these restrictions or road conditions in all cases. Always defer to all posted road signs and road conditions when making driving decisions.

By using different vehicle profiles, you can quickly change several device settings, such as which map layers are enabled and which route calculation mode is used by default.

Routing and navigation are calculated differently based on your vehicle profile. The device avoids including restricted or impassable areas in routes based on the dimensions, weight, and other characteristics you entered for your vehicle.

The current active vehicle profile is indicated by an icon in the status bar. The navigation and map settings on your device can be customized separately for each vehicle type.

Switching the Vehicle Profile

- 1 From the status bar, select the vehicle profile icon, such as  or .
- 2 Select a vehicle profile.
The vehicle profile information appears, including measurements and weight.
- 3 Select **Select**.

Choosing a Vehicle Profile

Select the vehicle profile icon on the status bar.







Adding a Vehicle Profile

You can add a vehicle profile for each vehicle to be used with your device.

- 1 Touch the current vehicle profile icon in the status bar.
- 2 Select .
- 3 Select your current vehicle type.
- 4 Enter the vehicle characteristics such as size and traction method.
- 5 Select the default route calculation method.

Editing a Vehicle Profile

You can change basic vehicle profile information or add detailed information to a vehicle profile, such as maximum speed.

- 1 Select  > **Vehicle Profile**.
- 2 Select a vehicle profile to edit.
- 3 Select an option:
 - To edit the vehicle profile information, select , and select a field to edit.
 - To rename the vehicle profile, select  >  > **Rename Profile**.
 - To delete the vehicle profile, select  >  > **Delete**.

Adding Portable Propane Tanks

NOTE: This feature is only available with certain vehicle profiles.

When you add your propane tanks to your vehicle profile, the device avoids routing through areas with propane tank restrictions that may affect your route. The device also alerts you when you approach areas that require you to shut off your propane tanks.

- 1 From the vehicle profile, select  > **Add Portable Tank**.
- 2 Enter the weight of the propane tank, and select **Save**.

Routes

A route is a path from your current location to one or more destinations.

- For off-road use, you can set the device to calculate point-to-point routes in a straight line.
- The device calculates a recommended route to your destination based on the preferences you set, including the route calculation mode and avoidances ([Avoiding Delays, Tolls, and Areas, page 33](#)).
- The device can automatically avoid roads that are not appropriate for the active vehicle profile.
- You can start navigating to your destination quickly using the recommended route, or you can select an alternate route ([Starting a Route, page 28](#)).
- If there are specific roads you need to use or avoid, you can customize the route ([Shaping Your Route, page 32](#)).
- You can add multiple destinations to a route ([Adding a Stop to Your Route, page 32](#)).

Starting a Route

You can start a route by searching for a location.

- 1 Select **Search**, and search for a location ([Finding and Saving Locations, page 41](#)).
- 2 Select a location.
- 3 Select an option:
 - To navigate using the default route calculation method for the current vehicle profile ([Vehicle Profiles, page 27](#)), select **Go!**.
 - To navigate to the location using adventurous routing ([Adventurous Routing, page 23](#)), select .

The device calculates a route to the location and guides you using voice prompts and information on the map ([Your Route on the Map, page 29](#)). A preview of the major roads in your route appears at the edge of the map for several seconds.

If you need to stop at additional destinations, you can add the locations to your route ([Adding a Stop to Your Route, page 32](#)).

Starting a Route to a Point on the Map





You can start a route by selecting a location from the map.

- 1 Select **View Map**.
- 2 Drag and zoom the map to display the area.
- 3 Select a point on the map.
- 4 Select **Go!**.

The device calculates a route using the default calculation method for your vehicle profile ([Vehicle Profiles, page 27](#)).

Planning a Route

A route can include many stops and shaping points, and it must include at least a starting location and one destination.

- 1 Select  > **Route Planner** > .
- 2 Search or select a location on the map to be the starting point for this route.
- 3 If necessary, select a route calculation mode for the route segment.
TIP: You can select to let the device automatically calculate the most adventurous route to your next destination ([Adventurous Routing, page 23](#)).
- 4 If the next point along your route is a stop, select **Stop**. Otherwise, select **Shaping**.
- 5 If necessary, add additional stops or shaping points.
NOTE: The last stop you add is the route destination.
- 6 If necessary, select  to rearrange the order of stops and shaping points along the route.
- 7 After you have finished planning the route, select .

Creating a Round-Trip Route

The device can create a round-trip route using a specified starting location and a distance, duration, or destination.

- 1 From the main menu, select  > **Round Trip**.
- 2 Select **Start Location**.
- 3 Search for a location or select a location, and select **Select**.
- 4 Select **Trip Attributes**.
- 5 Select an option:
 - Select **Choose a Distance** to plan your route by distance.
 - Select **Choose a Duration** to plan your route based on time.
 - Select **Choose a Destination** to plan your route to a specified location and back to the starting location.
- 6 Select **Next**.
- 7 Enter a distance, duration, or destination.
- 8 For routes based on distance or duration, select **Add a Direction**.
The route takes you in the selected direction and back.
- 9 Select **Road Type** to choose what type of road you prefer to ride on.
- 10 Select **Calculate**.
- 11 If necessary, adjust the slider to increase or decrease the adventurous routing level for your route ([Adventurous Routing, page 23](#)).
- 12 Select a route, and select **Go!**.

Navigating to a Saved Route

- 1 Select  > **Route Planner**.
- 2 Select a saved route.
- 3 Select **Go!**.
- 4 Select the first location to navigate to, and select **OK**.
- 5 Select **Start**.
The device calculates a route from your current location to the selected location, and then it guides you to the remaining route destinations in order.

Your Route on the Map

As you travel, the device guides you to your destination using voice prompts and information on the map. Instructions for your next turn or exit, or other actions appear across the top of the map.

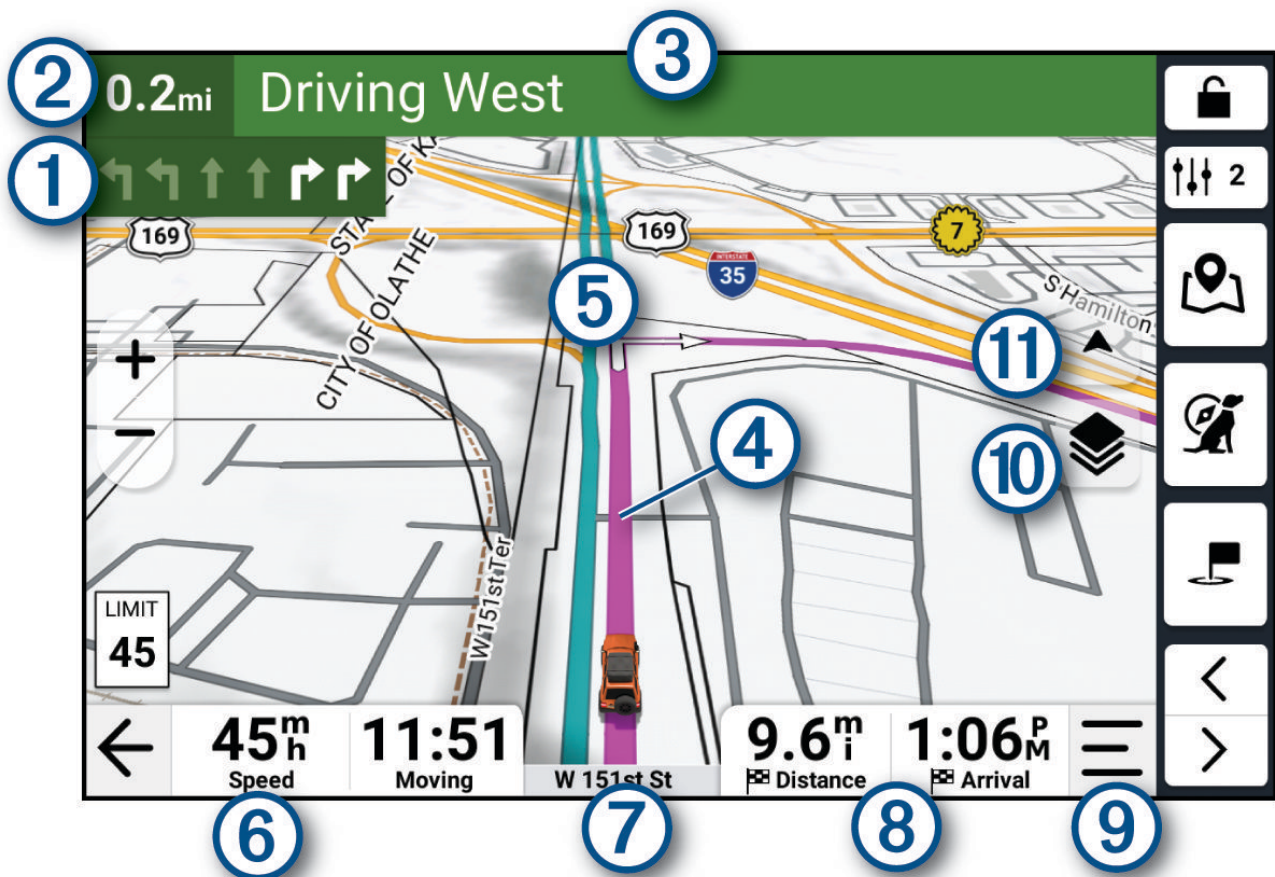

| | |
|---|---|
| ① | Next action in the route. Indicates the next turn, exit, or other action and the lane in which you should travel, if available. |
| ② | Distance to the next action. |
| ③ | Name of the street, exit, or direction associated with the next action. |
| ④ | Route highlighted on the map. |
| ⑤ | Next action in the route. Arrows on the map indicate the location of upcoming actions. |
| ⑥ | Vehicle speed. |
| ⑦ | Name of the road on which you are traveling. |
| ⑧ | Data fields. TIP: You can touch these fields to change the information they show. |
| ⑨ | Map tools. Provides tools to show you more information about your route and surroundings. |
| ⑩ | Map layers. Allows you to add map layers such as topographic and satellite imagery to your map view. |
| ⑪ | Map perspective. Allows you to change the map perspective between track up, north up, and 3-D. |

Active Lane Guidance

As you approach some turns, exits, or interchanges in your route, a detailed simulation of the road appears beside the map, if available. A colored line ① indicates the proper lane for the turn.

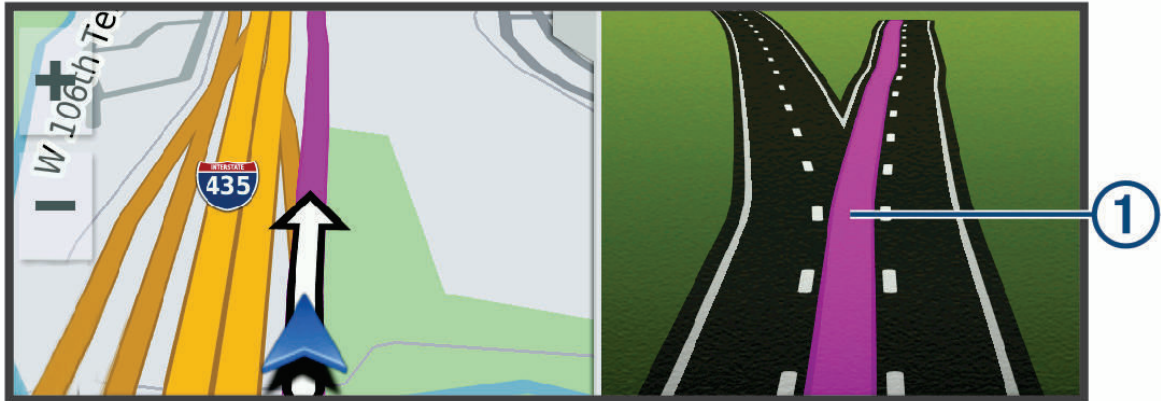

Viewing Turns and Directions

While navigating a route, you can view upcoming turns, lane changes, or other directions for your route.

1 From the map, select an option:

- To view upcoming turns and directions as you navigate, select  > **Turns**.
The map tool displays the next several turns or directions beside the map. The list updates automatically as you navigate the route.
- To view the complete list of turns and directions for the entire route, select the text bar at the top of the map.

2 Select a turn or direction (optional).

Detailed information appears. An image of the junction may appear for junctions on major roadways, if available.

Viewing the Entire Route on the Map

1 While navigating a route, select anywhere on the map.

2 Select .

Changing Your Active Route

Adding a Stop to Your Route

Before you can add a stop to your route, you must be navigating a route ([Starting a Route, page 28](#)).

You can add stops to the middle or end of your route. For example, you can add a fuel station as the next destination in your route.

TIP: To create complex routes with multiple destinations or scheduled stops, you can use the route planner to plan, schedule, and save a route ([Planning a Route, page 29](#)).

- 1 From the map, select  > **Search**.
- 2 Search for a location ([Finding and Saving Locations, page 41](#)).
- 3 Select a location.
- 4 Select **Go!**.
- 5 Select an option:
 - To stop the current route and start a new route to the location, select **Start New Route**.
 - To add the location as the next destination in your route, select **Add as Next Stop**.
 - To add the location to the end of your route, select **Add as Last Stop**.
 - To add the location and edit the order of destinations in your route, select **Add to Active Route**.

Skipping the Next Stop on Your Route

You can skip an upcoming location you previously added to your route.

From the map, select  > **Yes**.

Shaping Your Route



Before you can shape your route, you must start a route ([Starting a Route, page 28](#)).



You can manually shape your route to change its course without adding a stop.

- 1 Select a point on the map.
- 2 Select **Shape Route**.





The device recalculates the route to include the selected shaping point.
- 3 Select **Go!** to accept the new route.

Editing Your Active Route

- 1 Drag the map to reveal the  icon.
- 2 Select .
- 3 Select an option:
 - To recalculate the route to your next stop using a different route calculation mode, select the new calculation mode.
 - To add a stop or shaping point before your next stop, select **Insert**.

You can select  to search for a location, or you can select a point on the map to add it to your route.
 - To rearrange the order of the stops and shaping points along your route, select .
- 4 When you have finished editing the route, select .

Saving Your Active Route

- 1 Drag the map to reveal the  icon.
- 2 Select .
- 3 Select .
- 4 Select  to save the route.
- 5 If necessary, edit the name of the route, and select **Done**.

Avoiding Delays, Tolls, and Areas

Avoiding Traffic Delays on Your Route

Before you can avoid traffic delays, you must be receiving traffic information.

By default, the device optimizes your route to avoid traffic delays automatically. If you have disabled this option in the traffic settings ([Traffic Settings, page 62](#)), you can view and avoid traffic delays manually.

- 1 While navigating a route, select  > **Traffic**.
- 2 Select **Alternate Route**, if available.
- 3 Select **Go!**.

Avoiding Toll Roads

Your device can avoid routing you through areas that require tolls, such as toll roads, toll bridges, or congestion areas. The device may still include a toll area in your route if no other reasonable routes are available.

- 1 Select  > **Navigation** > **Avoidances** > **Toll Roads**.
- 2 Select **Save**.

Avoiding Toll Stickers

If the map data on your device contains detailed toll sticker information, you can avoid or allow roads that require toll stickers for each country.

NOTE: This feature is not available in all areas.

- 1 Select  > **Navigation** > **Toll Stickers**.
- 2 Select a country.
- 3 Select an option:
 - To be asked each time before routing through an area that requires toll stickers, select **Always Ask**.
 - To always avoid roads that require toll stickers, select **Avoid**.
 - To always allow roads that require toll stickers, select **Allow**.
- 4 Select **Save**.

Avoiding Road Features

- 1 Select  > **Navigation** > **Avoidances**.
- 2 Select the road features to avoid on your routes, and select **Save**.

Custom Avoidances

Custom avoidances allow you to select specific areas or sections of road to avoid. When the device calculates a route, it avoids these areas and roads unless no other reasonable route is available.

Avoiding a Road



- 1 Select  > **Navigation** > **Custom Avoidances**.
- 2 If necessary, select **Add Avoidance**.
- 3 Select **Add Avoid Road**.
- 4 Select the starting point of the section of road to avoid, and select **Next**.
- 5 Select the ending point of the road section, and select **Next**.
- 6 Select **Done**.

Avoiding an Area



- 1 Select  > **Navigation** > **Custom Avoidances**.
- 2 If necessary, select **Add Avoidance**.
- 3 Select **Add Avoid Area**.
- 4 Select the upper-left corner of the area to avoid, and select **Next**.
- 5 Select the lower-right corner of the area to avoid, and select **Next**.
The selected area is shaded on the map.
- 6 Select **Done**.

Disabling a Custom Avoidance

You can disable a custom avoidance without deleting it.

- 1 Select  > **Navigation** > **Custom Avoidances**.
- 2 Select an avoidance.
- 3 Select  > **Disable**.

Deleting Custom Avoidances

- 1 Select  > **Navigation** > **Custom Avoidances** > .
- 2 Select an option:
 - To delete all custom avoidances, select **Select All** > **Delete**.
 - To delete one custom avoidance, select the avoidance, and select **Delete**.

Taking a Detour

You can take a detour for a specified distance along your route or detour around specific roads. This is useful if you encounter construction zones, closed roads, or poor road conditions.

- 1 From the map, select  > **Edit Route**.
- 2 Select an option:
 - To detour your route for a specific distance, select **Detour by Distance**.
 - To detour around a specific road on the route, select **Detour by Road**.

Stopping the Route

From the map, select  > **Stop**.

Going Home

The first time you start a route home, the device prompts you to enter your home location.



- 1 Select **Search** > **Go Home**.
- 2 If necessary, enter your home location.

Editing Your Home Location

- 1 Select **Search** >  > **Set Home Location**.
- 2 Enter your home location.

Arriving at Your Destination

When you approach your destination, the device provides information to help you complete your route.

-  indicates the location of your destination on the map, and a voice prompt announces you are approaching your destination.
- When you approach some destinations while using an RV vehicle profile, the device automatically prompts you to plan your arrival at an RV destination, such as a parking area. You can select a suggested point on the map, and select **Go!** to navigate to that destination.
- When you stop at your destination, the device automatically ends the route. If the device does not detect your arrival automatically, you can select  > **Stop** to end your route.

Parking Near Your Destination

Your device can help you find a parking spot near your destination. When you approach some destinations, the device automatically suggests parking areas.

1 Select an option:

- When the device suggests parking, select **More** to see all of the suggested parking areas.
NOTE: When you select a suggested parking area, the device automatically updates your route.
- If the device does not suggest parking locations, select **Search** > **Categories** > **Parking**, and select **Near Destination** for the search area.

2 Select a parking location, and select **Go!**.

The device guides you to the parking area.

Tracks

Recording Tracks

Tracking records your path. When you start tracking, your device logs your location and updates the track line.

1 Select  > **Track Recorder**.

2 Select **Start**.

If your device is paired with the Alpha app, recorded tracks are periodically synchronized to your Garmin account.

You can retrace your recorded track by navigating it as a new route ([Converting a Track to a Route](#), page 35).

Following Your Most Recent Track

You can quickly retrace your most recent track back to its beginning.

1 Select  > **TracBack**.

Your most recent track appears on the map.

2 Select **Go!**.

Converting a Track to a Route

1 From the **Saved** app, open the track you want to convert ([Viewing Your Saved Items](#), page 49).

2 Select .

3 Select **Convert to Route** or **Save as Route**.

4 Select an option:

- Select **Start to Finish** to save the route in the same direction as the track.
- Select **Finish to Start** to save the route in the reverse direction of the track.

Using the Map

You can use the map to navigate a route ([Your Route on the Map, page 29](#)) or to view a map of your surroundings when no route is active.

- 1 Select **View Map**.
- 2 Touch anywhere on the map.
- 3 Select an option:
 - Drag the map to pan left, right, up, or down.
 - To zoom in or out, select **+** or **-**.
 - To switch between North Up, 2D, and 3D views, select **▲**.
 - To plan a route, drag the map to reveal the **📍📍** icon, and select **📍📍** ([Planning a Route, page 29](#)).
 - To start a route, select a location on the map, and select **Go!** ([Starting a Route to a Point on the Map, page 28](#)).

Map Tools

Map tools provide quick access to information and device functions while you view the map. When you activate a map tool, it appears in a panel at the edge of the map.

Stop: Stops navigation of the active route.

Edit Route: Allows you to take a detour or skip locations in your route ([Changing Your Active Route, page 32](#)).

Mute Navigation: Mutes the device audio.

Cities Ahead: Displays upcoming cities and services along your active route or along a highway ([Cities Ahead, page 37](#)).

Up Ahead: Displays upcoming locations along the route or the road on which you are traveling ([Up Ahead, page 37](#)).

Elevation: Displays upcoming elevation changes.

Traffic: Displays traffic conditions along your route or in your area ([Viewing Traffic Information, page 38](#)). This feature is not available in all areas.

Trip Data: Displays customizable trip data, such as speed or mileage ([Viewing Trip Data from the Map, page 38](#)).

Track Recorder: Displays the track data for your active track.

Turns: Displays a list of upcoming turns in your route ([Viewing Turns and Directions, page 31](#)).

Phone: Displays a list of recent phone calls from your connected phone, and displays in-call options while a phone call is active ([Using In-Call Options, page 59](#)).

Weather: Displays weather conditions for your area ([Viewing Weather Information, page 55](#)).

Smart Notifications: Displays recent smart notifications from your connected phone ([Smart Notifications, page 57](#)).

Pitch and Roll: Displays the current angle of your vehicle ([Pitch and Roll, page 24](#)).

Overview Map: Displays an overview of your route on the map.

Viewing a Map Tool

- 1 From the map, select **☰**.
- 2 Select a map tool to open it.

TIP: With some map tools, you can touch the map tools to expand it or show more detailed information.
- 3 When you are done using the map tool, select **✕**.

Up Ahead

The Up Ahead tool provides information about upcoming locations along your route or the road on which you are traveling. You can view upcoming points of interest by category, such as restaurants, fuel stations, or rest areas.

You can customize the categories that show in the Up Ahead tool.

Viewing Upcoming Locations

- 1 From the map, select  > **Up Ahead**.

While you are traveling, the map tool shows the next location along your road or route.

- 2 Select an option:
 - If the map tool shows categories, select a category to view a list of nearby locations in that category.
 - If the map tool shows upcoming locations, select a location to view location details or start a route to the location.

Customizing the Up Ahead Categories

You can change the location categories that appear in the Up Ahead tool.

- 1 From the map, select  > **Up Ahead**.

- 2 Select a category.

- 3 Select .

- 4 Select an option:

- To move a category up or down in the list, select and drag the arrow next to the category name.
- To change a category, select the category.
- To create a custom category, select a category, select **Custom Search**, and enter the name of a business or category.

- 5 Select **Save**.

Cities Ahead

While you are traveling on a highway or navigating a route that includes a highway, the Cities Ahead tool provides information about upcoming cities along the highway. For each city, the map tool shows the distance to the highway exit and the services available, similar to the information on highway road signs.

Viewing Upcoming Cities and Exit Services

- 1 From the map, select  > **Cities Ahead**.

While you are traveling along a highway or an active route, the map tool shows information about upcoming cities and exits.

- 2 Select a city.

The device shows a list of points of interest located at the selected city exit, such as fuel stations, lodging, or restaurants.

- 3 Select a location, and select **Go!** to start navigating.

Viewing Upcoming Elevation Changes

You can view upcoming elevation changes along your route. This can help you avoid or plan for steep uphill or downhill grades.

- 1 From the map, select  > **Elevation**.
- 2 Select the chart to expand it to the full screen.
The device displays your current elevation, and a chart of elevation over distance.
- 3 Select an option:
 - Select **+** or **-** to change the distance range of the chart.
 - Select the arrows to scroll the chart.

Viewing Traffic Information

Before you can view up-to-date traffic information, you must pair and connect your device to the Alpha app on your phone (*Pairing with Your Smartphone*, page 57).

NOTICE

Garmin is not responsible for the accuracy or timeliness of the traffic information.

- 1 From the map, select  > **Traffic**.
- 2 Touch the **Traffic** panel to view the traffic incidents on the map.

Viewing the Map Key

Elements on each map layer are color-coded to represent different information. You can view the map key to see what each color represents.

Select  > .

Viewing Trip Data

The trip data tool displays your speed and provides statistics about your trip.

From the map, select **Speed**.

Viewing Trip Data from the Map

Before you can view trip data on the map, you must add the tool to the map tools menu.

From the map, select  > **Trip Data**.



Customizing the Trip Data Fields

- 1 From the map, select  > **Trip Data**.
- 2 Select a trip data field.
- 3 Select an option.
The new trip data field appears in the trip data map tool.

Resetting Trip Information



- 1 From the map, select **Speed**.
- 2 Select  > **Reset Field(s)**.
- 3 Select an option:
 - When not navigating a route, select **Select All** to reset every data field except the speedometer, on the first page.
 - Select **Reset Overall Data** to reset Trip A and total data.
 - Select **Reset Trip B** to reset the odometer.
 - Select **Reset Max. Speed** to reset the maximum speed.
 - Select **Reset Max. Elevation** to reset the maximum elevation.

Viewing a Map Tool

- 1 From the map, select .
- 2 Select a map tool to open it.
TIP: With some map tools, you can touch the map tools to expand it or show more detailed information.
- 3 When you are done using the map tool, select .

Customizing the Map

Customizing the Map Layers

- 1 From the map, select  > **Layers**.
- 2 Under **Map Type**, select a map type.
With some map types, you can select  > **Hybrid Map** to combine two map types.
NOTE: The Satellite Imagery map shows satellite images only for areas where you have downloaded satellite imagery ([Downloading Outdoor Maps+ Content, page 39](#)).
- 3 Under **Map Details**, select the types of information to display over the map.
NOTE: Some layers are incompatible with each other and cannot be enabled at the same time. Enabling a layer automatically disables any incompatible layers.
NOTE: Some map layers require an Outdoor Maps+ subscription.





Downloading Outdoor Maps+ Content

Before you can download Outdoor Maps+ content, you must purchase an Outdoor Maps+ subscription. Go to garmin.com/outdoormaps for more information.

You must connect your device to Wi-Fi before you can download Outdoor Maps+ content ([Connecting to a Wi-Fi Network, page 67](#)).

To see Outdoor Maps+ content on the map, you must download the content for a specific area.

NOTE: Some Outdoor Maps+ layers are available only in certain areas.

- 1 Select  > **Map** > **Map Manager** > **Outdoor Maps+** > **Download Maps**.
- 2 Select .
- 3 Select each map layer you want to download.
TIP: You can touch  to see information about each map layer.
The selected map layers are marked with a checkmark.
- 4 Select .
- 5 Drag the map and pinch to zoom in and out on the map until the highlighted rectangle covers the area for which you want to download map data.
TIP: As you change the size of the area, the total download size and your current disk usage appear at the top of the screen.
- 6 Select  to start downloading.
You can continue using your device while it downloads Outdoor Maps+ content.

Viewing Your Collections on the Map

Before you can view the Collections map layer, you must pair your device with the Alpha app to sync your device with your Garmin account.

You can view the items from your Garmin account directly on the map.

NOTE: Items from your Garmin account that were not added to any collection appear in the Unorganized collection on your Alpha XL device.

- 1 From the map, select  > **Collections**.
- 2 Select one or more collection categories from the list.
The tracks, routes, and waypoints from the selected collections appear as icons on the map.

Changing the Map Data Field

- 1 From the map, select a data field.
NOTE: You cannot customize Speed.
- 2 Select a type of data to display.

Changing the Map Buttons

- 1 From the map, hold a map button.
- 2 Select an option:
 - To replace a map button, select a map button, and select a map button to display.
 - To remove a map button, select .
- 3 Select **Save**.

Changing the Map Perspective

- 1 Select  > **Map** > **Driving Map View**.
- 2 Select an option:
 - Select **Track Up** to display the map in two dimensions (2-D), with your direction of travel at the top.
 - Select **North Up** to display the map in 2-D with north at the top.
 - Select **3-D** to display the map in three dimensions.
 - Select **Auto Zoom to Group** to automatically adjust the zoom level so all dogs and contacts are visible on the map.
- 3 Select **Save**.

Changing the Map Region

When the device is connected to a Wi-Fi network, you can download new map regions directly onto the device.

- 1 Select  > **Map Manager** > **Manage Device Maps**.
- 2 Select an option:
 - To remove a map region, select the region, and select **Remove**.
 - To install a new map region to the device's internal memory, select the region, and select **Install to Device**.
 - To install a new map region to a memory card (*Installing a Memory Card for Maps and Data, page 64*), select the region, and select **Install to the Memory Card**.

As you add or remove new regions, a bar at the top of the page displays the available storage space on the device.

- 3 After you have finished adding and removing map regions, select **Apply**.

Finding and Saving Locations

The maps loaded in your device contain locations, such as restaurants, hotels, auto services, and detailed street information. The Search menu helps you find your destination by providing several methods to browse, search, and save this information.

From the main menu, select **Search**.

- To quickly search all locations on your device, select  **Search** (*Finding a Location Using the Search Bar, page 42*).
- To find an address, select **Address**.
- To browse or search pre-loaded points of interest by category, select **Categories** (*Finding a Location by Category, page 42*).
- To search near a different city or area, select the current search area, and select a new search area (*Changing the Search Area, page 44*).
- To view and edit your saved locations, select **Waypoints** (*Saving Locations, page 48*).
- To view locations you have recently selected from the search results, select **Recent** (*Viewing Recently Found Locations, page 47*).
- To find parks with trails for off-road vehicles, select **Off-Road Parks**.
- To search for RV parks and campgrounds, select **Ultimate Public Campgrounds** (*Finding Ultimate Campgrounds Points of Interest, page 46*).
- To search for locations that are part of your Outdoor Maps+ subscription, select **Outdoor Maps+**.
- To search for United States National Forest locations such as trailheads and recreation areas, select **USFS Points**.
- To browse and search Tripadvisor® traveler ratings, select **Tripadvisor** (*Finding Tripadvisor Points of Interest, page 47*).
- To find national parks and explore park maps, select **National Parks** (*Finding National Parks, page 46*).
- To navigate to specific geographic coordinates, select **Coordinates** (*Finding a Location Using Coordinates, page 45*).

Points of Interest

NOTICE

You are responsible for understanding and complying with any applicable rules, laws, or regulations associated with points of interest.

A point of interest is a place that you may find useful or interesting. Points of interest are organized by category and can include popular travel destinations such as gas stations, restaurants, hotels, and entertainment venues.

Finding a Location Using the Search Bar

You can use the search bar to search for locations by entering a category, brand name, address, or city name.

- 1 Select **Search**.
- 2 Select **Search** in the search bar.
- 3 Enter all or part of the search term.
Suggested search terms appear below the search bar.
- 4 Select an option:
 - To search for a type of business, enter a category name (for example, "movie theaters").
 - To search for a business name, enter all or part of the name.
 - To search for an address near you, enter the house number and street name.
 - To search for an address in another city, enter the house number, street name, city, and state.
 - To search for a city, enter the city and state.
 - To search for coordinates, enter latitude and longitude coordinates.
- 5 Select an option:
 - To search using a suggested search term, select the term.
 - To search using the text you entered, select .
- 6 If necessary, select a location.

Finding a Location by Category

- 1 Select **Search**.
- 2 Select a category, or select **Categories**.
- 3 If necessary, select a subcategory.
- 4 Select a location.

Navigating to Points of Interest Within a Venue

NOTE: This feature is not available for all locations.

You can create a route to a point within a larger venue, such as a specific store in a shopping mall, a terminal at an airport, or nearby parking areas.

- 1 Select **Search > Search**.
- 2 Enter the name of the venue, and select .
- 3 Select the venue.
A list of categories for points of interest within the venue appears.
- 4 Select a category, select a location, and select **Go!**.

The device creates a route to the parking area or venue entrance closest to the selected point.

Location Search Results

The location search results appear in a list, with the nearest location at the top. Each numbered location also appears on the map. You can scroll down to view more results.

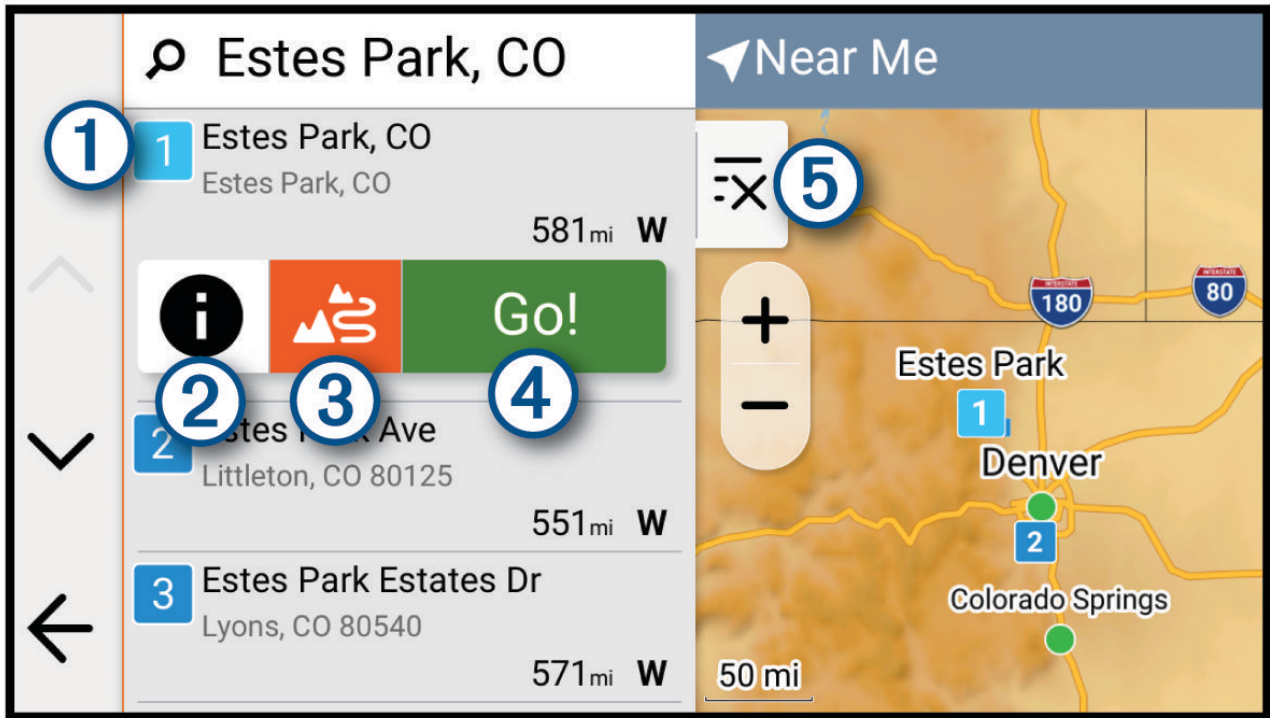

| | |
|--------------|--|
| ① | Select a location to view the option menu. |
| ② i | Select to view detailed information about the location. |
| ③ | Select to start navigating using adventurous routing (Adventurous Routing, page 23). |
| ④ Go! | Select to start navigating to the location using the default route calculation mode for the current vehicle profile. |
| ⑤ | Select to view the search results on the map in full screen. |

Changing the Search Area

By default, the device searches for locations near your current location. You can also search other areas, such as near your destination, near another city, or along your active route.

- 1 Select **Search**.
- 2 Select the current search area ①.

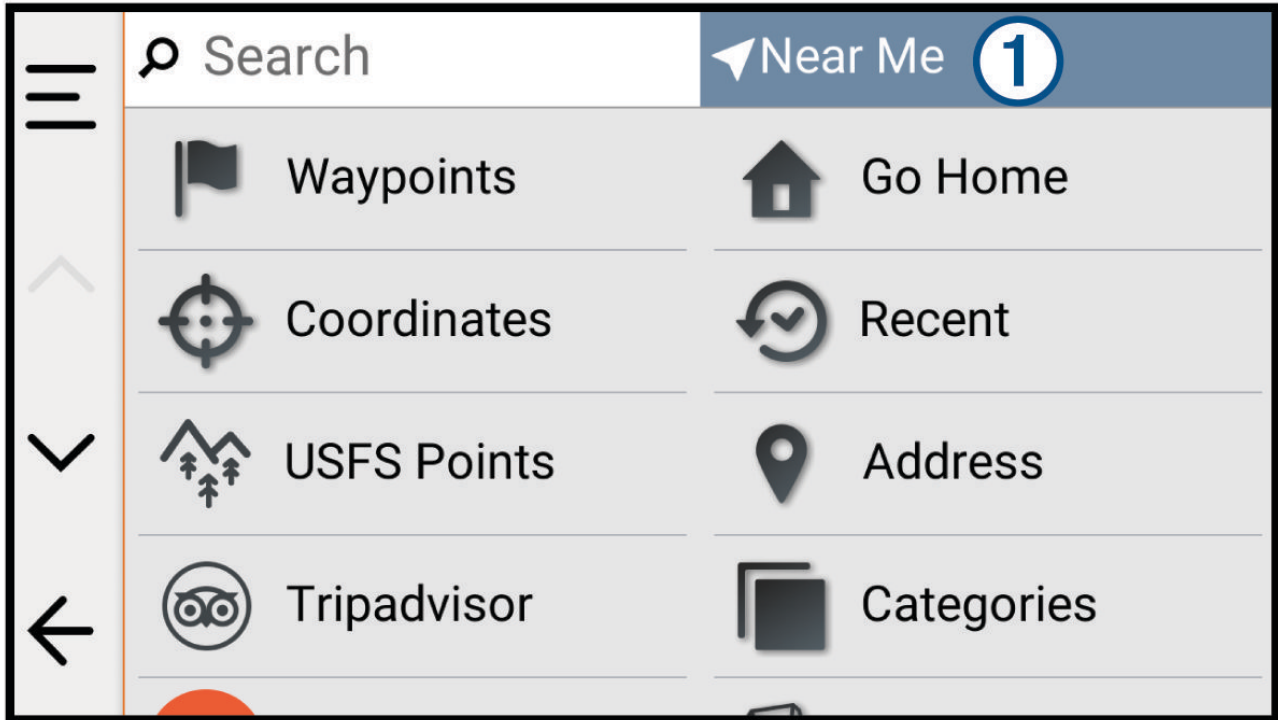

- 3 Select a search area.
- 4 If necessary, follow the on-screen instructions to select a specific location.

The selected search area appears at the top of the screen. When you search for a location using any of the options in the Search menu, the device suggests locations near this area first.

Finding Parking Near Your Current Location

- 1 Select **Search > Categories > Parking**.
- 2 Select a parking location.
- 3 Select **Go!**.

Finding Parking Near a Specified Location

- 1 Select **Search**.
- 2 Select the current search area ①.

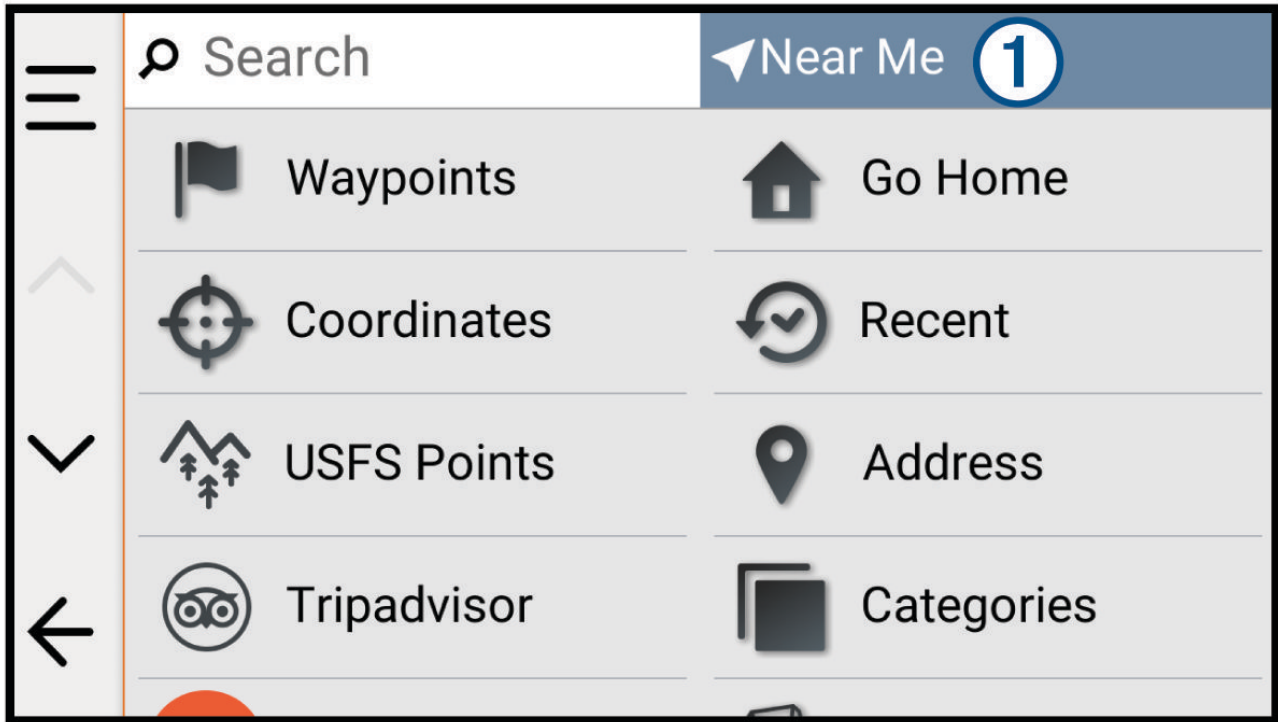

- 3 Select **Select a Location**.
- 4 Follow the on-screen instructions to select a location.
- 5 Select **Categories > Parking**.
Parking options near the selected location appear.
- 6 Select a parking location.
- 7 Select **Go!**.

Finding an Address

NOTE: The order of the steps may change depending on the map data loaded on your device.

- 1 Select **Search**.
- 2 If necessary, select the current search area to search near a different city or area.
- 3 Select **Address**.
- 4 Follow the on-screen instructions to enter address information.
- 5 Select the address.

Finding a Location Using Coordinates

You can find a location using latitude and longitude coordinates.

- 1 Select **Search > Coordinates**.
- 2 If necessary, select , and change the coordinate format or datum.
- 3 Select **Coordinates**.
- 4 Enter the latitude and longitude coordinates, and select **Done**.
- 5 Select an option:
 - To save the coordinates as a location, select **Save**.
 - To start a route to the coordinates, select **Go!**.

Finding Fuel Stations and Prices

Before you can use this feature, your device must be connected to a supported phone running the Alpha app (*Pairing with Your Smartphone*, page 57).

You can find nearby fuel stations and compare fuel prices.

- 1 Select **Search** > **Categories** > **Fuel Stations**.
- 2 If necessary, select , select a fuel type, and select **Save**.
Fuel prices appear under each station in the search results.
- 3 Select a fuel station.

Finding National Parks

Device models that include maps for North America or the United States also include detailed information for national parks in the United States. You can navigate to a national park or to a location within a national park.

NOTICE

You are responsible for understanding and complying with any applicable rules, laws, or regulations associated with national parks.

- 1 Select **Search** > **National Parks**.
A list of national parks appears, with the nearest park at the top.
- 2 Select **Search**, and enter all or part of the park name to narrow the results (optional).
- 3 Select a national park.
A list of categories for locations of features and amenities within the park appears below the park name.
- 4 Select an option:
 - To start navigating to the park, select **Go!**.
 - To view more park information or explore the park features and amenities, select .
 - To quickly find a location within the park, select a category from the list below the park name, and select a location.

Finding Ultimate Campgrounds Points of Interest

NOTE: This feature is not available in all areas.

NOTICE

You are responsible for understanding and complying with any applicable rules, laws, or regulations associated with campsites and points of interest.

Your device includes Ultimate Campgrounds points of interest, which allow you to find public campgrounds near your location.

- 1 Select **Search** > **Ultimate Public Campgrounds**.
- 2 If necessary, select **Search Filters**, select one or more search filters, and select **Search**.
- 3 Select a location.

Tripadvisor

NOTICE

Garmin is not responsible for the accuracy or timeliness of the Tripadvisor information.

You are responsible for understanding and complying with any applicable rules, laws, or regulations associated with points of interest.

Your device includes Tripadvisor traveler ratings. Tripadvisor ratings appear automatically in the search results list for restaurants, hotels, and attractions. You can also search for nearby Tripadvisor points of interest and sort by distance or popularity.

Finding Tripadvisor Points of Interest

- 1 Select **Search > Tripadvisor**.
- 2 Select a category.
- 3 If necessary, select a subcategory.
A list of nearby Tripadvisor points of interest for the category appears.
- 4 Select **Sort Results** to filter the displayed points of interest by distance or popularity (optional).
- 5 Select , and enter a search term (optional).

Viewing Recently Found Locations

Your device stores a history of the last 50 locations you have found.

Select **Search > Recent**.

Clearing the List of Recently Found Locations

Select **Search > Recent >  > Clear > Yes**.

Viewing Current Location Information

You can use the Where Am I? page to view information about your current location. This feature is helpful if you need to tell emergency personnel your location.

From the map, select the vehicle.

Finding Emergency Services and Fuel

You can use the Where Am I? page to find the nearest hospitals, police stations, and fuel stations.

- 1 From the map, select the vehicle.
- 2 Select **Hospitals, Police Stations, or Fuel**.
A list of locations for the selected service appears, with the nearest locations at the top.
- 3 Select a location.
- 4 Select an option:
 - To navigate to the location, select **Go!**
 - To view the phone number and other location details, select .

Getting Directions to Your Current Location

If you need to tell another person how to get to your current location, your device can give you a list of directions.

- 1 From the map, select the vehicle.
- 2 Select  > **Directions to Me**.
- 3 Select a starting location.
- 4 Select **Select**.

Adding a Shortcut

You can add shortcuts to the Where To? menu. A shortcut can point to a location, a category, or a search tool. The Where To? menu can contain up to 36 shortcut icons.

- 1 Select **Search > Add Shortcut**.
- 2 Select an item.

Removing a Shortcut

- 1 Select **Search** >  > **Remove Shortcut(s)**.
- 2 Select a shortcut to remove.
- 3 Select the shortcut again to confirm.
- 4 Select **Done**.

Saving Locations

Saving a Location

- 1 Search for a location (*Finding and Saving Locations, page 41*).
- 2 Select a location from the list of search results.
- 3 Select  > **Save**.
- 4 If necessary, select **Name** to edit the name of the location.
- 5 Select **Save**.

Saving Your Current Location

- 1 From the map, select the vehicle icon.
- 2 Select **Save**.
- 3 If necessary, select **Name** to edit the name of the location.
- 4 Select **Save**.

Editing a Saved Location

- 1 Select **Search** > **Waypoints**.
- 2 If necessary, select a category.
- 3 Select a location.
- 4 Select **Edit**.
- 5 Select an option:
 - Select **Name**.
 - Select **Map Symbol** to change the symbol used to mark the saved location on a map.
 - Select **Collections** to add or remove the location from your saved collection categories.
 - Select **Coordinates** to edit the GPS coordinates for the location.
- 6 Edit the information.
- 7 Select **Done**.



Deleting a Saved Location

NOTE: Deleted locations cannot be recovered.

- 1 Select **Search** > **Waypoints**.
- 2 Select a waypoint.
- 3 Select **Edit** > **Delete** > **Yes**.

Viewing Your Saved Items

You can use the Saved app to view your saved items, such as waypoints, routes, and tracks. When paired with the Alpha app, your saved items periodically sync with your Garmin account.

- 1 Select  > **Saved**.
- 2 If necessary, select the category filter  to browse different collections and filter by item type.

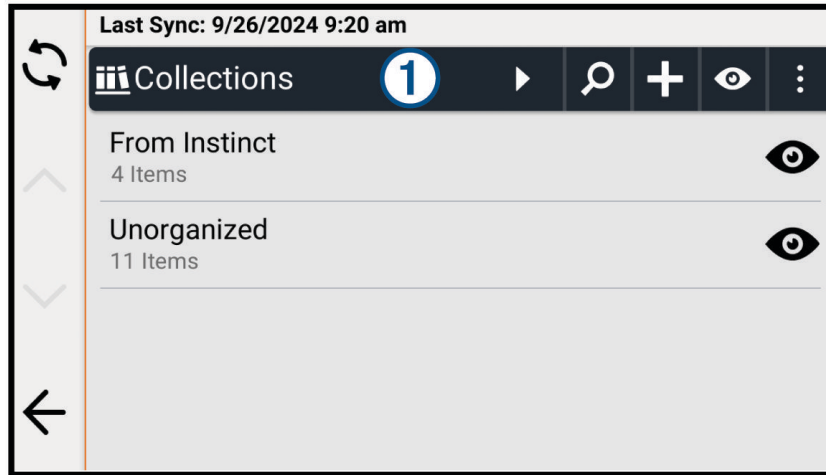



Sharing a Saved Item

You can share items using a memory card.

- 1 From the **Saved** app, select the item you want to share.
- 2 Select an option:
 - To share a route or track, select  > **Share**.
 - To share a waypoint, select **Share**.
- 3 Select an option:
 - To save the item to a memory card, select **Memory Card**.
 - To save the item to a memory card as a Lowrance compatible GPX file, enable the **Lowrance Compatible GPX File** option, and select **Memory Card**.
- 4 If necessary, edit the name for the .gpx file.

Sharing Multiple Saved Items

You can share multiple items in a single .gpx file.

- 1 From the **Saved** app, select a category or collection filter including all the items you want to share.
- 2 Select  > **Share**.
- 3 Select the items to share.
- 4 Select .
- 5 Select an option:
 - To save the items to a memory card, select **Memory Card**.
 - To save the items to a memory card as a Lowrance compatible GPX file, enable the **Lowrance Compatible GPX File** option, and select **Memory Card**.
- 6 If necessary, edit the name for the .gpx file.

Synchronizing Garmin Account Data







Before you can synchronize account data, you must pair your device with the Alpha app ([Pairing with Your Smartphone, page 57](#)).

You can synchronize data, such as tracks, with your Garmin account. Your device periodically synchronizes data with your account automatically. You can also synchronize data manually at any time.

- 1 Select  > **Saved**.
- 2 Select .

Using the Apps

Using the Competition Timer

- 1 Select  > **Competition Timer**.
- 2 Select an option:
 - To set the competition timer duration and alerts, select .
 - To create a customized timer that counts up from zero, select , and enter a name for the timer.
 - To start a competition timer, select .
 - To stop a competition timer, select .
 - To reset the competition timer, select .

Wireless Cameras

Your device can display the video feed from one or more connected wireless cameras (sold separately).

Pairing the Device with a Wireless Camera

You can pair a wireless camera with your Alpha XL device.

- 1 Update your Alpha XL device to the latest software version ([Map and Software Updates, page 66](#)).
Your device may not support the wireless camera without the latest software.
- 2 Select  > **Cameras** > **Add New Camera**.
- 3 Follow the on-screen instructions to finish pairing and setting up the camera.

After you complete the pairing process with a camera for the first time, it connects automatically to the Garmin navigation device when power is applied.

Viewing the Camera

WARNING

This device is intended to enhance situational awareness when used properly. If used improperly, you could become distracted by the display, which could lead to an accident causing serious personal injury or death. Always view the display at a glance when the vehicle is in motion to avoid becoming distracted.



Select  > **Cameras**.

Aligning the Guidance Lines

For the best reference points, the guidance lines should be aligned to reflect the outside edges of the vehicle. You should align the guidance lines separately for each backup camera. On some models, adjustment is automatically available after pairing a camera.

⚠ WARNING

You must ensure that the guidance lines are properly aligned before using the device and after making any camera angle adjustments. Failure to properly align the guidance lines could result in an accident or collision, resulting in death, serious injury, or property damage.

- 1 Position the vehicle with one side closely aligned to a curb, driveway, or parking stall lines.
You may want to position the vehicle in the center of a parking stall, and then pull forward into the next stall. This allows you to use the parking stall lines in the rear of the vehicle as reference points for alignment. The curb, driveway, or parking stall lines should be clearly visible on the device.
- 2 Select an option:
 - From the camera view, tap the screen, and select .
 - From the camera view, select  > **Adjust Video**.
- 3 Drag the circles on the corners of the guidance lines , or tap the arrows until they match the angle and position of the curb, driveway, or parking stall lines.
The guidance lines should appear directly on top of your reference points.
The red or orange section of the guidance lines should align with the rear of your vehicle.

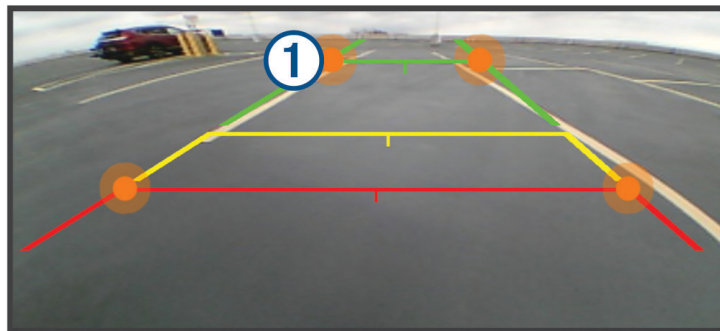

- 4 If necessary, reposition the vehicle with the other side closely aligned to a curb, driveway, or parking stall lines, and repeat the alignment process.
You should attempt to keep the guidance lines symmetrical, even if your vehicle is not in perfect alignment with the curb, driveway, or parking stall lines.
- 5 Select  after alignment is complete.

Garmin PowerSwitch™ App

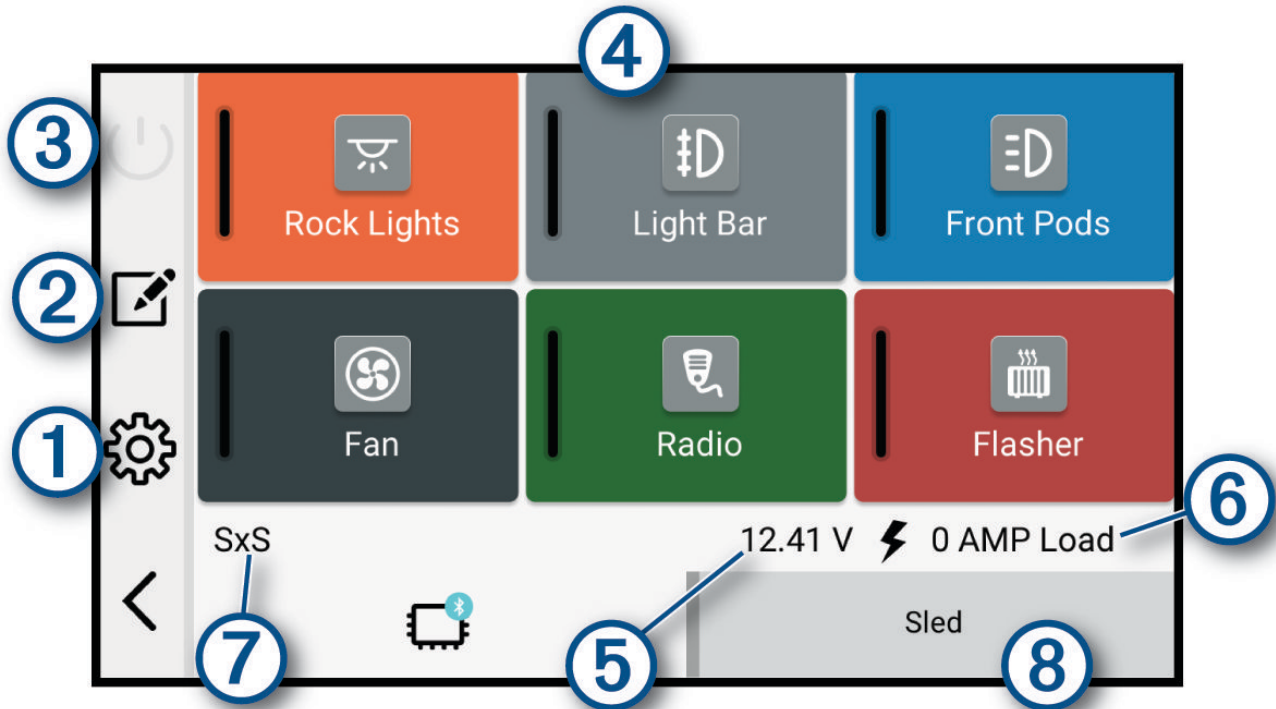

| | |
|-----------------|---|
| ① | Opens the app settings menu |
| ② | Enters editing mode to customize the app layout and functions |
| ③ | Turns off all outputs |
| ④ Power buttons | Activates each connected output |
| ⑤ | Displays input voltage |
| ⑥ | Displays the total amperage of the selected Garmin PowerSwitch device |
| ⑦ | Displays the device name |
| ⑧ | Displays Garmin PowerSwitch device tabs and custom layout tabs |

Activating a Power Switch





Before you can use the Garmin PowerSwitch app to activate a switch, you must install your Garmin PowerSwitch device in your vehicle and pair it with the Garmin PowerSwitch app.

From the Garmin PowerSwitch app, select a power button to turn a switch on or off.

Turning Off All Switches

Select .

Customizing a Button

- 1 From the Garmin PowerSwitch app screen, select .
The app enters editing mode.
- 2 Select  on the button you want to customize.
- 3 When you have finished customizing the button, select .
- 4 Select .

Assigning a Switch to a Control Input



Before you can use control input functions, you must connect a control input to your Garmin PowerSwitch device.

You can assign one or more switches to turn on when the Garmin PowerSwitch device receives a signal from a control input.



- 1 Select .
- 2 Select your Garmin PowerSwitch device.
- 3 Select a control input.
- 4 Select one or more switches.

Adding a Custom Layout



You can add a custom layout tab to the Garmin PowerSwitch app. Buttons added to a custom layout can control multiple switches at the same time.

- 1 From the Garmin PowerSwitch app, select .
The device enters editing mode.
- 2 Select .



Adding a Button to a Custom Layout

- 1 From the Garmin PowerSwitch app, select a custom layout tab.
- 2 Select .
The app enters editing mode.
- 3 Select **Add Button**.
- 4 On the new button, select .
- 5 Select an option:
 - To change the name of the button, select the **Label** field, and enter a name.
 - To add an icon to the button, select the **Icon** field, and select an icon.
 - To change the button color, select a color.
- 6 Select **Add Action**.
- 7 If necessary, select a Garmin PowerSwitch device and a switch.
- 8 Select an action:
 - To set the button to turn the switch on or off with each press, select **Toggle**.
 - To set the button to turn on the switch, select **Turn On**.
 - To set the button to turn off the switch, select **Turn Off**.
- 9 Select a button mode:
 - To set the button to activate with one touch, select **Normal**.
 - To set the button to activate only while touching the button, select **Momentary**.
 - To set the button to turn on and off repeatedly, select **Strobe**, and select time intervals.
- 10 If applicable, use the slider to set the brightness of lights.
- 11 Select .
- 12 If necessary, select **Add Action** to add additional actions for the button.
You can add one action for every switch on the Garmin PowerSwitch device.

Arranging Buttons In a Custom Layout

- 1 From the Garmin PowerSwitch app, select a custom layout tab.
- 2 Select .
The app enters editing mode.
- 3 On the button you want to move, hold  and drag the button to a new location.

Deleting a Custom Layout or Button

- 1 From the Garmin PowerSwitch app, select a custom layout tab.
- 2 Select .
The app enters editing mode.
- 3 Select an option:
 - To delete a button, select  on the button you want to delete.
 - To delete a layout tab, select  on the layout tab.



Routines

Routines automate your Garmin PowerSwitch device. When you define a routine on your compatible Garmin navigation device, it turns switches on or off automatically when the conditions of the routine are met. For example, you can set a routine to turn on a switch at specific time each day or when your vehicle reaches a specific speed. Routines are available only when using a compatible Garmin navigation device.



Adding a Routine

- 1 From the Garmin PowerSwitch app, select  > **Routines**.
- 2 If necessary, select **Add Routine**.
- 3 Select **When**.
- 4 Select a trigger:
 - To set a switch to trigger when your vehicle reaches a specific speed, select **Speed** > **Next**, and follow the on-screen instructions to enter speed thresholds.
 - To set a switch to trigger at a specific time each day, select **Time** > **Next**, and enter a time.
 - To set a switch to trigger at sunrise, select **Sunrise**.
 - To set a switch to trigger at sunset, select **Sunset**.
- 5 Select **Add Action**.
- 6 Select a device, a switch, an action, and a button mode.
- 7 If necessary, use the slider to adjust the dimmer.
- 8 Select **Save**.

Editing a Routine

- 1 From the Garmin PowerSwitch app, select  > **Routines**.
- 2 Select  on the routine you want to edit.
- 3 Select an option:
 - To change the trigger for the routine, select **When**, and select a trigger.
 - To change an action, select  on the action you want to change, and update the action.
 - To add an action to the routine, select **Add Action**, and enter information about the action.
- 4 Select **Save**.

Deleting a Routine



- 1 From the Garmin PowerSwitch app, select  > **Routines**.
- 2 Select  on the routine you want to delete.

Viewing Weather Information

Before you can view up-to-date weather information, you must pair and connect your device to the Alpha app on your phone (*Pairing with Your Smartphone*, page 57).

NOTICE

Garmin is not responsible for the accuracy or timeliness of the weather information.

- 1 Select  > **Weather**.
The device shows the current weather conditions and a forecast for the next several days.
- 2 Select an option:
 - Select a day to view a detailed forecast.
 - Select **Radar** to view the weather radar map.
 - Select **Conditions** to view a road conditions map.
 - Select **Alerts** to view a severe weather alert map.
 - Select  to view the weather forecast for a different city.

Driver Awareness Features and Alerts

CAUTION

The driver alerts and speed limit features are for information only and do not replace your responsibility to abide by all posted speed limit signs and to use safe driving judgment at all times. Garmin is not responsible for any traffic fines or citations you receive for failing to follow all applicable traffic laws and signs.

Your device provides features that can help encourage safer driving, even when you are driving in a familiar area. The device plays an audible tone or message and displays information for each alert. You can enable or disable the audible tone or message for each type of alert. Not all alerts are available in all areas.

School zone or nearby school: The device plays a tone and displays the distance to and speed limit (if available) for an upcoming school or school zone.

Speed limit reduction: The device plays a tone and displays the upcoming reduced speed limit so you can be prepared to reduce your speed.

Speeding alert: The device displays a red border on the speed limit icon when you exceed the posted speed limit for the current road.

Railroad crossing: The device plays a tone and displays the distance to an upcoming railroad crossing.

Animal crossing: The device plays a tone and displays the distance to an upcoming animal crossing area.

Curve: The device plays a tone and displays the distance to a curve in the road.

Slower traffic: The device plays a tone and displays the distance to slower traffic when you approach slower traffic at a higher speed. Your device must be receiving traffic information to use this feature.

Enabling or Disabling Driver Alerts

You can enable or disable several types of driver alerts.

- 1 Select  > **Driver Assistance** > **Driver Alerts**.
- 2 Select or clear the check box next to each alert.
- 3 Select **OK**.

Live Services, Traffic, and Smartphone Features

WARNING

Do not read or interact with notifications while driving, because doing so can cause distraction which could lead to an accident resulting in serious personal injury or death.

NOTICE

Garmin is not responsible for the accuracy or timeliness of the traffic information.

The Alpha app allows your device to receive smart notifications and live information, such as live traffic data and weather information.

Live traffic data: Sends live traffic data to your device, such as traffic incidents and delays, construction zones, and road closings ([Viewing Traffic Information, page 38](#)).

Weather information: Sends real-time weather forecasts, road conditions, and weather radar to your device ([Viewing Weather Information, page 55](#)).

Smart Notifications: Displays phone notifications and messages on your device. This feature is not available for all languages.

Hands-Free calling: Allows you to place and receive phone calls through the device using your connected Bluetooth headset.

Send locations to device: Allows you to send locations from your smartphone to your navigation device.

Pairing with Your Smartphone

You can pair your Alpha XL navigator with your smartphone and the Alpha app to enable additional features and access live information.

- 1 From the app store on your smartphone, install the Alpha app.
- 2 Turn on your Alpha XL navigator, and place the navigator and your smartphone within 3 m (10 ft.) of each other.
- 3 On your phone, open the Alpha app.
- 4 Follow the on-screen instructions to sign in to a Garmin account and complete the pairing and setup process.

The main app dashboard appears. After the devices are paired, you can enable or disable smartphone features on your navigator. The devices connect automatically when they are turned on and within range.

Smart Notifications

While your device is connected to the Alpha app, you can view notifications from your smartphone on your Alpha XL device, such as text messages, incoming calls, and calendar appointments.

Receiving Notifications

WARNING

Do not read or interact with notifications while driving, because doing so can cause distraction that could lead to an accident resulting in serious personal injury or death.

Before you can use this feature, your device must be connected to a supported phone running the Alpha app ([Pairing with Your Smartphone](#), page 57).

From most pages, a popup appears when the device receives a notification from your smartphone. If the device is moving, you must verify you are a passenger and not the driver before you can view notifications.

NOTE: If you are viewing the map, notifications appear in a map tool.

- To ignore a notification, select **OK**.
The popup closes, but the notification remains active on your phone.
- To view a notification, select **View**.
- To listen to the notification, select **View >** .
- To perform additional actions, such as dismissing the notification from your phone, select **View**, and select an option.

NOTE: Additional actions are available for only some notification types and must be supported by the app generating the notification.



Receiving Notifications while Viewing the Map

WARNING

Do not read or interact with notifications while driving, because doing so can cause distraction that could lead to an accident resulting in serious personal injury or death.

Before you can use this feature, your device must be connected to a supported phone running the Alpha app ([Pairing with Your Smartphone, page 57](#)).

When you are viewing the map, new notifications appear in a map tool at the edge of the screen. If the device is moving, you must verify you are a passenger and not the driver before you can view notifications.

- To ignore a notification, select , or wait for popup to expire.
The popup closes, but the notification remains active on your phone.
- To view a notification, select the notification text.
- To listen to the notification, select .
The device reads the notification using text-to-speech technology. This feature is not available for all languages.

Viewing the List of Notifications

You can view a list of all active notifications.

- 1 Select  > **Smart Notifications**.

The list of notifications appears. Unread notifications appear black, and previously read notifications appear gray.

- 2 Select an option:

- To view a notification, select the notification description.
- To listen to a notification, select .

The device reads the notification using text-to-speech technology. This feature is not available for all languages.

Hands-Free Calling

NOTE: While most phones are supported and can be used, it cannot be guaranteed that a particular phone can be used. All features may not be available for your phone.

Using Bluetooth wireless technology, your device can connect to your mobile phone to become a hands-free device ([Pairing with Your Smartphone, page 57](#)). While connected, you can place or receive calls using your device.

Enabling Hands-Free Calling

Before you can enable hands-free calling features, you must pair your Alpha navigator with the Alpha app on a compatible phone ([Pairing with Your Smartphone, page 57](#)).

- 1 Select  > **Phone**.
- 2 Select your paired phone.
- 3 Select **Phone calls**.

Placing a Call

- 1 Select  > **Phone**.
- 2 Select an option:
 - To dial a number, select **Dial**, enter the phone number, and select **Dial**.
 - To view numbers of recent, missed, or recently dialed or received calls, select **Call History**, select a log, select a number, and select **Call** to dial it.
 - To call a contact from your phone book, select **Phone Book**, select a contact, and select **Call**.
 - To call a point of interest location such as a restaurant or attraction, select **Browse Categories**, select a category, select a location, and select **Call**.

Calling Home

Select  > **Phone** > **Call Home**.

When using this feature for the first time, you are prompted to dial the home phone number.

TIP: You can reset the home phone number by selecting  > **Set Home Number**.

Placing a Call Using Voice Dial

Before you can use voice dialing, the voice assistant app on your phone must be available.

- 1 Select  > **Phone** > **Voice Dial**.
- 2 Listen for the voice prompt.
- 3 Say **Call**, and say the contact name, phone number, or location you want to call.

Receiving a Call

When you receive a call, select **Answer** or **Dismiss**.

Using In-Call Options

In-call options are available when you answer a call. Some options may not be compatible with your phone.

TIP: If you close the in-call options page, you can open it again by selecting  from any screen. You can also select the caller from the map.

- To set up a conference call, select **Add Call**.
- To transfer audio to your phone, select **Call in Progress on Navigator**.
TIP: You can use this feature if you want to disconnect the Bluetooth connection and remain on the call, or if you need privacy.
- To use the dial pad, select **Keypad**.
TIP: You can use this feature to use automated systems, such as voice mail.
- To mute the microphone, select **Mute**.
- To hang up, select **End Call**.

Disabling Phone Calls

You can disable phone calls while keeping other features enabled.

- 1 Select  > **Phone**.
- 2 Select the phone.
- 3 Clear the **Phone calls** check box.



Disconnecting a Bluetooth Device

You can temporarily disconnect a Bluetooth device without deleting it from the paired devices list. The Bluetooth device can connect to your Alpha device automatically in the future.

- 1 Select  > **Phone**.
- 2 Select the device to disconnect.
- 3 Select **Disconnect**.

Deleting a Bluetooth Device

You can delete a paired phone or headset to prevent it from automatically connecting to your device in the future.

- 1 Select an option:
 - To delete a phone, select  > **Phone**.
 - To delete a headset, select  > **Headset**.
- 2 Select the device to delete.
- 3 Select **Forget Device**.

Settings

Dog Tracking Settings

Select  > **Dog Tracking**.

Tracking Auto Zoom: Allows the map to zoom out automatically, so the selected devices are always displayed on the map.

Dog Tracks on Map: Determines how much of the track log for a tracked dog collar appears on the map.

Contact Tracks on Map: Determines how much of the track log for a tracked handheld device appears on the map.

Clear Tracks on Map: Clears all of the dog and contact track logs.

Dog Display: Sets how the dog information is shown on the map (*Dog Display Settings, page 60*).

Dog Alerts: Sets options for alerts and notifications related to dog tracking (*Dog Alerts Settings, page 60*).

Contact Message Alerts: Sets alerts that appear when receiving a message from a contact.

Back Up and Restore: Allows you to back up or restore your dog data.

Dog Display Settings

Select  > **Dog Tracking** > **Dog Display**.

Indicator: Sets the dog indicator to show the direction of the dog's movement or the dog's status.

Indicator Icon Size: Sets the size of the dog indicator.

Show Dog Names: Enables or disables dog names on the map.

Show Dog Distances: Enables or disables dog distances on the map.

Dog Label Size: Sets the size of the dog labels on the map.

Show Lost Dog Timer: Enables or disables a timer that shows the length of time communication with a dog collar device has been lost.

Show Barks: Enables or disables an indicator that shows when a dog is barking.

Dog Alerts Settings

Select  > **Dog Tracking** > **Dog Alerts**.

On-Point Alert: Sets the alert type for when a dog is on-point.

Treed Alert: Sets the alert type for when a dog has treed game.

GPS Lost Alert: Sets the alert type for when GPS signals are lost.

Lost Comm. Alert: Sets alert types for when communication is lost between the navigator and a paired dog or contact.

Speed Setup: Sets alerts related to a dog's speed.

Bark Setup: Sets alerts related to bark detection.

Backing Up and Restoring Dog Data

You can back up or restore your dog tracking data so you can return to it at a later time.

1 Select  > **Dog Tracking** > **Back Up and Restore**.

2 Select an option:

- To enable an automatic backup, select the **Auto Back Up** option.
- To back up your dog data, select **Back Up Now**.
- To restore your dog data from a backup, select **Restore Now**, and select a backup file.

Phone Settings

Select  > **Phone**, and select your phone.

Disconnect: Disconnects the paired phone.

Phone Name: Displays the name of the paired phone. You can select the name to change how it displays on your navigation device.

Smart Notifications: Allows you to enable phone notifications from your compatible phone.

Garmin Alpha: Appears when the navigation device is connected to the Alpha app on your phone.

Forget Device: Removes the connected device from the list of paired devices. This option is available only after a device is paired.

Wi-Fi Settings

The wireless network settings allow you to manage Wi-Fi networks.

Select  > **Wi-Fi**.

Wi-Fi: Enables the Wi-Fi radio.

Saved Networks: Allows you to edit or remove saved networks.

Search for Networks: Searches for nearby Wi-Fi networks ([Connecting to a Wi-Fi Network, page 67](#)).

Map Settings

Select  > **Map**.

Map Vehicle Icon: Sets the vehicle icon that represents your position on the map.

Driving Map View: Sets the perspective on the map.

Map Detail: Sets the level of detail on the map. More detail may cause the map to draw slower.

Adventure Roads & Trails: Selects what types of adventure roads and trails are highlighted on the map.

Waypoint Labels: Sets the size of waypoint labels on the map.

Waypoint Decluttering: Hides waypoint icons at high map zoom levels.

Range Rings: Shows rings on the map, representing distance from you. The distance to the innermost ring is shown on the bottom left corner of the screen.

NOTE: Range rings are shown only while using the Track Up or North Up map perspective ([Changing the Map Perspective, page 40](#)).

Auto Zoom: Automatically selects the zoom level for optimal use of your map. When disabled, you must zoom in or out manually.

Skip Next Stop Confirmation: Sets a confirmation message to appear when skipping a location on your route.

Map Manager: Manages maps installed on the device ([Changing the Map Region, page 40](#)).

Navigation Settings

Select  > **Navigation**.

Off-Route Recalculation: Sets recalculation preferences when navigating away from an active route.

Avoidances: Sets road features to avoid on a route.

Custom Avoidances: Allows you to avoid specific roads or areas.

Traffic: Sets options for traffic features ([Traffic Settings, page 62](#)).

Environmental Zones: Sets the avoidance preferences for areas with environmental or emissions restrictions that may apply to your vehicle.

Restricted Mode: Disables all functions that require significant operator attention.

GPS Simulator: Stops the device from receiving a GPS signal, and saves battery power.

Traffic Settings

From the main menu, select  > **Navigation** > **Traffic**.

Traffic: Enables the traffic feature.

Current Provider: Sets the provider to use for traffic data. The Auto option selects the best available traffic data automatically.

Subscriptions: Lists the current traffic subscriptions.

Optimize Route: Enables the device to use optimized alternate routes automatically or upon request (*Avoiding Traffic Delays on Your Route*, page 33).

Setting a Simulated Location

If you are indoors or not receiving satellite signals, you can use the GPS simulator to plan routes from a simulated location.

- 1 Select  > **Navigation** > **GPS Simulator**.
- 2 From the main menu, select **View Map**.
- 3 Tap the map twice to select an area.
The address of the location appears at the bottom of the screen.
- 4 Select the location description.
- 5 Select **Set Location**.

Driver Assistance Settings

Select  > **Driver Assistance**.

Driver Alerts: Allows you to enable or disable alerts for upcoming zones or road conditions (*Driver Awareness Features and Alerts*, page 56).

Speeding Alert: Alerts you when you are exceeding the speed limit.

Reduced Speed Tone: Alerts you when the speed limit decreases.

Country Border Alert: Displays a notification when crossing international borders.

Route Preview: Displays a preview of the major roads in your route when you start navigation.

Upcoming Services: Displays services up ahead on long trips.

Proximity Alerts Settings

NOTE: You must have custom points of interest (POIs) loaded for proximity points alerts to display.

NOTE: This feature is not available in all areas.

Select  > **Driver Assistance** > **Proximity Alerts**.

Audio: Sets the style of alert that plays when you approach proximity points.

Alerts: Sets the type of proximity points for which alerts are played.

Display Settings

Select  > **Display**.

Brightness Slider: You can move the slider to adjust the display brightness.

Orientation: Allows you to set the display to portrait (vertical) or landscape (horizontal).

Color Mode: Allows you to select day or night color mode. If you select the Auto option, the device automatically switches to day or night colors based on the time of day.

Display Timeout: Allows you to set the amount of idle time before your device enters sleep mode while using battery power.

External Power Prompts: Allows you to set power management options when the device loses external power.

Screenshot: Allows you to take a picture of the device screen. Screenshots are saved in the Screenshot folder of the device storage.

System Settings

Select  > **System**.

Voice Language: Sets the language for voice prompts.

Text Language: Sets all on-screen text to the selected language.

NOTE: Changing the text language does not change the language of user-entered data or map data, such as street names.

Keyboard Language: Enables keyboard languages.

Units: Sets the unit of measure used for distances.

Current Time: Sets the device time.

Time Format: Allows you to select a 12-hour, 24-hour, or UTC display time.

Position Format: Sets the coordinate format and datum used for geographical coordinates.

Position Format Settings

NOTE: Do not change the position format or the map datum coordinate system unless you are using a map or chart that specifies a different position format.

Select  > **System** > **Position Format**.

Coordinate Format: Sets the position format for the location information.

Display Format: Sets the format in which coordinates will appear on the device.

Datum: Sets the coordinate system on which the map is structured.

Map Spheroid: Shows the coordinate system the device is using. The default coordinate system is WGS 84.

Device and Privacy Settings

Select  > **Device**.

About: Displays the software version number, the unit ID number, and information on several other software features.

Regulatory: Displays regulatory markings and information.

EULAs: Displays the end-user license agreements.

NOTE: You need this information when you update the system software or purchase additional map data.

Software Licenses: Displays software licensing information.



Device Data Reporting: Shares anonymous data to improve the device.

Travel History: Allows the device to store a record of the places you go. This allows you to view the trip log, use the Trip History feature, and use myTrends™ suggested routes.

Reset: Allows you to clear your travel history, reset settings, or delete all user data.

Restoring Settings

You can restore a category of settings or all settings to the factory default values.

- 1 Select .
- 2 If necessary, select a settings category.
- 3 Select  > **Restore**.

Data Management

The device has a memory card slot for additional data storage.

NOTE: The device is compatible with Windows® 7 and newer, and Mac® OS 10.7 and newer.

About Memory Cards

You can purchase memory cards from an electronics supplier, or purchase pre-loaded Garmin mapping software (www.garmin.com). Memory cards can be used to store files such as maps and POIs.

Installing a Memory Card for Maps and Data

You can install a memory card to increase the storage space for maps and other data on your device. You can purchase memory cards from an electronics supplier. Memory cards must use the exFAT file system format.

- 1 Locate the map and data memory card slot on your device ([Device Overview, page 1](#)).
- 2 Insert a memory card into the slot.
- 3 Press it in until it clicks.

Connecting the Device to Your Computer

You can connect the device to your computer using a USB cable.

- 1 Plug the small end of the USB cable into the port on the device.
- 2 Plug the larger end of the USB cable into a port on your computer.
- 3 From your Alpha XL device, select **Tap to Connect to Computer**.

A picture of your device connected to a computer appears on the device screen.

Depending on your computer operating system, the device appears as either a portable device, a removable drive, or a removable volume.

NOTE: Mac computers do not detect the device by default. You must use Garmin Express™ software to interact with files on your device.

Transferring GPX Files From Your Computer

If you have already created routes that you want to use on your device, you can transfer GPX files directly from your computer.

- 1 Connect the device to your computer ([Connecting the Device to Your Computer, page 64](#)).
The device appears as a portable device.
- 2 On your computer, open the file browser.
- 3 Select a GPX file.
- 4 Select **Edit > Copy**.
- 5 Browse to the GPX folder on the device.
- 6 Select **Edit > Paste**.

Transferring Data From Your Computer

- 1 Connect the device to your computer ([Connecting the Device to Your Computer, page 64](#)).
Depending on your computer operating system, the device appears as either a portable device, a removable drive, or a removable volume.
- 2 On your computer, open the file browser.
- 3 Select a file.
- 4 Select **Edit > Copy**.
- 5 Browse to a folder on the device.
NOTE: For a removable drive or volume, you should not place files in the Garmin folder.
- 6 Select **Edit > Paste**.

Adding BaseCamp™ Data to Garmin Explore™

You can export your BaseCamp data files and import them to Garmin Explore for use with your Alpha XL device.

- 1 Export your data from BaseCamp:
 - If you are using an Apple® computer, see *Exporting Data from BaseCamp with an Apple Computer*, page 65.
 - If you are using a PC, see *Exporting Data from BaseCamp with a PC*, page 65.
- 2 Import your BaseCamp data to the Garmin Explore website (*Importing Data to Garmin Explore*, page 65).
- 3 Synchronize your Garmin Explore data with your Alpha XL device (*Synchronizing Garmin Account Data*, page 50).

Exporting Data from BaseCamp with a PC

- 1 Select an option:
 - To export all BaseCamp data stored on your computer, select **My Collection**, and select **File > Export > Export 'My Collection'**.
 - To export one or more items or a list, select one or more items or a list, and select **File > Export > Export Selection**.
- 2 Enter a name, select a location for the exported file, select the file format, and select **Save**.

Exporting Data from BaseCamp with an Apple Computer

- 1 Select an option:
 - To export all BaseCamp data stored on your computer, select **My Collection**, and select **File > Export 'My Collection'**.
 - To export one or more items or a list, select one or more items or a list, and select **File > Export Selected User Data**.
- 2 Enter a name.
- 3 Select a location for the exported file.
- 4 Select the file format.
- 5 Select **Export**.

Importing Data to Garmin Explore

- 1 Go to explore.garmin.com and log in to your account.
- 2 Select the **Map** tab.
- 3 Select .
- 4 Follow the on-screen instructions.

The data syncs to the Alpha app and your Alpha XL device automatically.

Device Information

Viewing E-label Regulatory and Compliance Information

- 1 From the settings menu, swipe to the bottom of the menu.
- 2 Select **Device > Regulatory**.

Specifications

| | |
|---|---------------------------------------|
| Operating temperature range | From -20° to 55°C (from -4° to 131°F) |
| Charging temperature range | From 0° to 45°C (from 32° to 113°F) |
| Power input (vehicle power cable or external power) | From 12 to 24 Vdc |
| Battery type | Non-replaceable lithium-ion battery |

Charging the Device

NOTE: This Class III product shall be powered by an LPS power supply.

You can charge the battery in the device using any of these methods.

- Install the device in the mount, and connect the mount to vehicle power.
- Connect the device to an optional power adapter accessory, such as a wall power adapter.

You can purchase an approved Garmin AC-DC adapter suitable for home or office use from a Garmin dealer or www.garmin.com. The device may charge slowly when connected to a third-party adapter.

Device Maintenance

Map and Software Updates

For the best navigation experience, you should keep the maps and software on your device up to date.

Map updates provide the newest available changes to roads and locations in the maps used by your device. Keeping maps up to date helps your device find recently added locations and calculate more accurate routes. Map updates are large and may take several hours to complete.

Software updates provide changes and improvements to the device features and operation.

You can update your device using two methods.



- You can connect the device to a Wi-Fi network to update directly on the device (recommended). This option allows you to update your device conveniently without connecting it to a computer.
- You can connect the device to a computer and update it using the Garmin Express application (garmin.com/express).

Updating Maps and Software Using a Wi-Fi Network

NOTICE

Map and software updates may require the device to download large files. Regular data limits or charges from your internet service provider apply. Contact your internet service provider for more information about data limits or charges.

You can update the maps and software by connecting your device to a Wi-Fi network that provides access to the internet. This allows you to keep your device up to date without connecting it to a computer.

- 1 Connect the device to a Wi-Fi network ([Connecting to a Wi-Fi Network, page 67](#)).
While connected to a Wi-Fi network, the device checks for available updates. When an update is available,  appears on the  icon in the main menu.
- 2 Select  > **Updates**.
The device checks for available updates. When an update is available, **Update Available** appears below Map or Software.
- 3 Select an option:
 - To install all available updates, select **Install All**.
 - To install only map updates, select **Map > Install All**.
 - To install only software updates, select **Software > Install All**.
- 4 Read the license agreements, and select **Accept All** to accept the agreements.
NOTE: If you do not agree with the license terms, you can select **Reject**. This stops the update process. You cannot install updates until you accept the license agreements.
- 5 Using the included USB cable, connect the device to external power, and select **Continue** ([Charging the Device, page 66](#)).
For the best results, a USB wall charger that provides at least 2 A power output is recommended. Many USB power adapters for smartphones, tablets, or portable media devices may be compatible.
- 6 Keep the device connected to external power and within range of the Wi-Fi network until the update process is complete.

TIP: If a map update is interrupted or canceled before it completes, your device may be missing map data. To repair missing map data, you must update the maps again using either Wi-Fi or Garmin Express.

Connecting to a Wi-Fi Network



The first time you turn on the device, it prompts you to connect to a Wi-Fi network. You can also connect to a Wi-Fi network using the settings menu.

- 1 Select  > **Wi-Fi**.
- 2 If necessary, select **Wi-Fi** to enable Wi-Fi technology.
- 3 Select **Search for Networks**.
The device displays a list of nearby Wi-Fi networks.
- 4 Select a network.
- 5 If necessary, enter the password for the network, and select **Done**.

The device connects to the network, and the network is added to the list of saved networks. The device reconnects to this network automatically when it is within range.

Updating Maps and Software with Garmin Express

You can use the Garmin Express application to download and install the latest map and software updates for your device.

- 1 If you do not have the Garmin Express application installed on your computer, go to garmin.com/express and follow the on-screen instructions to install it.
- 2 Open the  Garmin Express application.
- 3 Connect your device to your computer using a USB-C® cable.
The small end of the cable connects to the USB-C port  on your Alpha XL device, and the large end connects to an available USB port on your computer.

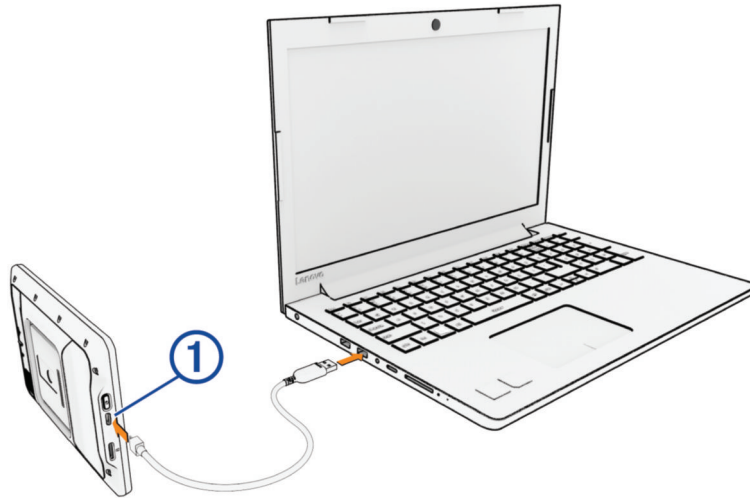

- 4 From your Alpha XL device, select **Tap to Connect to Computer**.
- 5 In the Garmin Express application, click **Add a Device**.
The Garmin Express application searches for your device and displays the device name and serial number.
- 6 Click **Add Device**, and follow the on-screen instructions to add your device to the Garmin Express application.
When setup is complete, the Garmin Express application displays the updates available for your device.

Updates Available

Last Checked: Just Now 

Estimated Install Time: 1 hour and 18 minutes

[View Details](#)

[Install All](#)

7 Select an option:

- To install all available updates, click **Install All**.
- To install a specific update, click **View Details**, and click **Install** next to the update you want.

The Garmin Express application downloads and installs the updates onto your device. Map updates are very large, and this process may take a long time on slower internet connections.

NOTE: If a map update is too large for the internal storage of the device, the software may prompt you to install a microSD® card in your device to add storage space (*Installing a Memory Card for Maps and Data*, page 64).

8 Follow the on-screen instructions during the update process to finish installing updates.

For example, during the update process, the Garmin Express application may instruct you to disconnect and reconnect your device.

Device Care

NOTICE

Avoid dropping your device.

Do not store the device where prolonged exposure to extreme temperatures can occur, because it can cause permanent damage.

Never use a hard or sharp object to operate the touchscreen, or damage may result.

Cleaning the Outer Casing

NOTICE

Avoid chemical cleaners and solvents that can damage plastic components.

- 1 Clean the outer casing of the device (not the touchscreen) using a cloth dampened with a mild detergent solution.
- 2 Wipe the device dry.

Cleaning the Touchscreen

- 1 Use a soft, clean, lint-free cloth.
- 2 If necessary, lightly dampen the cloth with water.
- 3 If using a dampened cloth, turn off the device and disconnect the device from power.
- 4 Gently wipe the screen with the cloth.

Cleaning the USB Port

- 1 Turn off the device and disconnect the device from power.
- 2 Clean the USB port using a soft, clean, lint-free cloth or cotton swab.
NOTE: If necessary, you can lightly dampen the cloth or cotton swab with isopropyl alcohol.
- 3 Allow the device to dry completely before you connect it to power.

Restarting the Device

You can restart your device if it stops functioning.

Hold the power button for 12 seconds.

Troubleshooting

My device is not acquiring satellite signals

- Verify the GPS simulator is turned off (*Navigation Settings, page 61*).
- Take your device out of parking garages and away from tall buildings and trees.
- Remain stationary for several minutes.

My device does not connect to my phone

- Select  > **Phone**, and verify that your phone is paired with the navigator.
- Enable Bluetooth wireless technology on your phone, and bring your phone within 10 m (33 ft.) of the device.
- Verify your phone is compatible.
Go to www.garmin.com/bluetooth for more information.
- Complete the pairing process again.
To repeat the pairing process, you must unpair your phone and device (*Disconnecting a Bluetooth Device, page 59*), and complete the pairing process (*Pairing with Your Smartphone, page 57*).

The device does not charge in my vehicle



- Verify the vehicle is turned on and is supplying power to the power outlet.
- Verify the interior temperature of the vehicle is within the charging temperature range indicated in the specifications.
- In the vehicle fuse box, verify the fuse for the vehicle power outlet is not broken.

My battery does not stay charged for very long

- Decrease the screen brightness (*Display Settings, page 62*).
- Shorten the display timeout (*Display Settings, page 62*).
- Decrease the volume (*Adjusting the Volume, page 9*).
- Turn off Wi-Fi technology when it is not in use (*Wi-Fi Settings, page 61*).
- Put the device in power saving mode when not in use (*Turning the Device On or Off, page 6*).
- Keep your device away from extreme temperatures.
- Do not leave your device in direct sunlight.

My device does not connect to my computer

If you connect the device to your computer but a notification does not appear, you can follow these steps.

- 1 If necessary, select  to return to the main menu.
- 2 Select .
- 3 Select **Tap to Connect to Computer**.

Appendix

Bare Wire Power Cable

⚠ WARNING

Garmin strongly recommends having an experienced installer with the proper knowledge of electrical systems install the device. Incorrectly wiring the power cable can result in damage to the vehicle, the battery, or the device and can cause bodily injury.

You can purchase an optional bare wire power adapter for use in vehicles that are not equipped with a CLA power outlet. You can also use this cable in applications where a hardwired permanent power source is preferred. The device must be mounted in a suitable and secure location in your vehicle, based on available power sources and safe cable routing. You can purchase a bare wire power cable from your Garmin dealer, or you can go to buy.garmin.com.

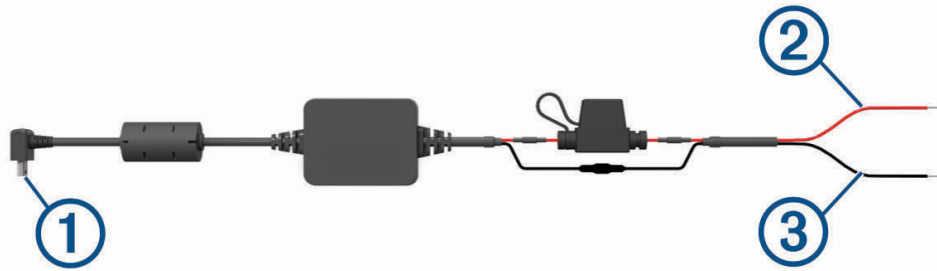

| | |
|---|---------------------------------------|
| ① | Device power connector |
| ② | 10 to 30 Vdc system input power (red) |
| ③ | System ground (black) |

Pairing a Tempe Sensor

- 1 Turn on your tempe™ sensor and bring it within 3 m (10 ft.) of your navigator.
- 2 From the main menu on your navigator, select **⚙ > Sensors > Tempe Sensor > Search for New.**
- 3 If necessary, select **Enable Sensor** to start receiving data from the tempe sensor.

To see tempe sensor data on the map, select a customizable data field, and select Temperature.

