

# ***EDGE2***

## **Owner's Manual**

Please read this manual thoroughly  
before operating the EDGE2  
training e-collar.

Visit [Gun Dog Supply.com](http://GunDogSupply.com)  
Order a Dogtra Edge2  
See other Dogtra Products

# IMPORTANT SAFETY AND PRODUCT INFORMATION

## **WARNING**

Read all safety and product information below before using Dogtra products. Failure to follow these safety instructions could result in injury to you, your dog, and/or damage to Dogtra products or other property.

## **PRODUCT SAFETY**

### **Training Methods**

Dogtra products can be used with a variety of training methods. However, each dog may respond differently to training methods and Dogtra products. Observe your dog closely when determining the correct training method to use with Dogtra products.

### **Aggressive Dogs**

Do not use Dogtra products on aggressive dogs. Such dogs may react adversely and cause injury to people or other dogs. When dealing with an aggressive dog, seek the help of a dog training professional or veterinarian.

### **Children and the disabled**

Dogtra products are not toys. Adult supervision and extreme caution are required when Dogtra products are used by or near children.

## **PRODUCT DAMAGE**

### **Electrical Product**

Dogtra products include electrical components and batteries. Do not use or store the product near heat or flammable substances. Such use or storage may damage the product or cause fire, explosion, personal injury, or property damage.

## **Medical Device Interference**

Dogtra products contain electrical and magnetic components that emit low levels of electromagnetic radiation and radio frequencies. These electromagnetic waves or radio frequencies may interfere with pacemakers, defibrillators, or other medical devices. Consult your physician or medical device manufacturer before using any medical device with Dogtra products. If you think Dogtra products may interfere with your pacemaker, defibrillator, or other medical device, stop using Dogtra products.

## **Inadvertent Activation**

The digital microprocessor offers thousands of unique codes to eliminate frequency match-up with other Dogtra e-collars. The Constant button will automatically shut down after being held down for 12 seconds or more as a safety feature.

## **Charging**

Only charge Dogtra products with Dogtra Branded batteries and device chargers. Do not charge the product by any other means or at temperatures below 0°C (32°F) or above 45°C (113°F).

## **Unauthorized use**

Dogtra products should only be used in a humane manner to train and educate dogs.

Dogtra products are not intended for use in any other way and are not intended for use on other animals or humans.

## **Battery removal and disposal**

Dogtra products include batteries. Be careful when removing or installing the battery as your fingers may be caught. Dispose of batteries according to local regulations. Do not disassemble, crush, heat or modify the battery. Fire, injury or property damage may result.

# CONTENTS

AT A GLANCE .....	6
MAIN FEATURES .....	7
OVERVIEW .....	8
<b>UNDERSTANDING YOUR TRAINING SYSTEM</b>	
1. TURNING THE PRODUCT ON/OFF .....	10
2. TRANSMITTER BUTTON FUNCTION .....	11
3. TRANSMITTER BUTTON ASSIGNMENT .....	13
4. CHANGING THE STIMULATION DIAL .....	14
5. SAFETY LEVEL LOCK .....	17
6. HOW TO ADD AN ADDITIONAL RECEIVER DEVICE .....	18
<b>HOW TO USE THE RECEIVER</b>	
1. RECEIVER FITTING .....	19
2. HOW TO INSERT THE STRAP .....	20
3. OBTAINING MAXIMUM DISTANCE .....	21
4. FINDING THE RIGHT STIMULATION LEVEL .....	23
5. NON-STIMULATION CONTACTS .....	24
6. LED INDICATOR .....	25
7. CHANGING THE LOCATE LED LIGHT COLOR .....	26
8. CARE FOR LCD TRANSMITTERS IN COLD TEMPERATURE .....	27
9. BATTERY CHARGE .....	28
10. ATTACHING THE BELT CLIP .....	30

11.USING THE TEST LIGHT .....	31
GENERAL TRAINING TIPS .....	33
MAINTENANCE .....	35
TROUBLESHOOTING GUIDE .....	36
FCC/ISED WARNING STATEMENT .....	38
WARRANTY AND REPAIR INFORMATION .....	39

# AT A GLANCE



## Optional Accessories

### Auto Charger

The input of the car charger for EDGE2 is 12V - 24V and the output is 5V 1000mA.

### European Charger

Dogtra's European chargers are designed for use with 220V AC electrical outlets.

To purchase accessories, visit [www.dogtra.com](http://www.dogtra.com) or call customer service at (888) 811-9111.

# MAIN FEATURES

- 1.2-mile range for reliable control at distance
- Dedicated buttons for up to four dogs — no toggling required
- No-look operation for fast and precise timing
- Designed for efficient, uninterrupted multi-dog training
- Vulcanized coated on the back for a better grip
- IPX9K waterproof for water work and harsh conditions
- New Performance PWM stimulation technology ensures consistent, reliable performance — even when submerged
- 127-level stimulation with Rheostat Dial
- 10-level stimulation with Selector Dial
- Instant access to Nick, Constant, Pager, and Tone
- XPP (Extreme Performance Pager) Vibration
- Safety Stimulation Level Lock
- High output receiver
- 1 1/8" LCD Display
- LCD screen display for stimulation level and battery life
- Locate LED Light with 4 selectable colors (white, red, blue and green)
- USB C-TYPE Charging

# OVERVIEW



**EDGE2**  
Transmitter

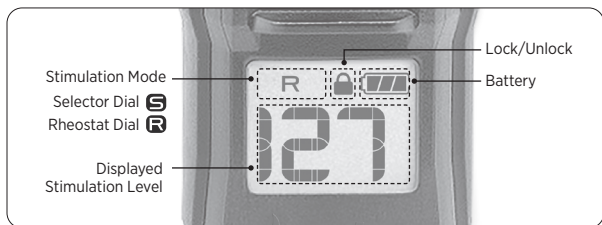

## EDGE2 Transmitter LCD Screen



### **PERFORMANCE PWM STIMULATION TECHNOLOGY**

Reliable & precise correction at all conditions

**IPX9K** Certified  
Waterproof

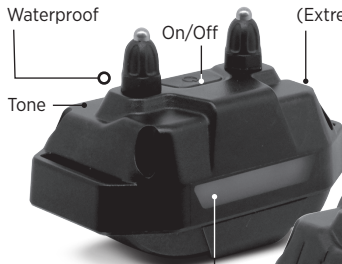

**1000 LUX**  
LED Light [Bottom]

**XPP Vibration**  
(Extreme Performance Pager)

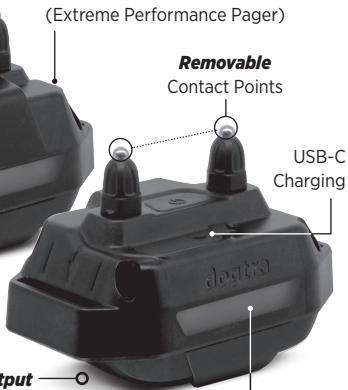

**1000 LUX**  
LED Light [Top]

**High Output**

## EDGE2 Receiver

# UNDERSTANDING YOUR TRAINING SYSTEM

## 1. TURNING THE PRODUCT ON/OFF



The remote transmitter's power button is located on the top right. Press and hold the power button for 2 seconds to turn it on or off.



The receiver's collar power button is located between the contacts. Press and hold the power button for 2 seconds to turn it on or off. The LED indicator will turn solid green with a tone when the unit powers on and a red light with a tone when it powers off.

## 2. TRANSMITTER BUTTON FUNCTION



Turn the Mode Selection Dial to choose the desired function and press the button on the front for the receiver you would like to use.

### Stimulation Features



#### **C** CONSTANT

Constant button emits a continuous stream of stimulation when held, lasting up to 12 seconds maximum.

#### **N** NICK

When the Nick button is pressed, the receiver emits a single rapid pulse of static stimulation.

## Non-Stimulation Features



### **P** XPP (Extreme Performance Pager) **Vibration**

Provides vibration for up to 12 seconds when held.



### **T** TONE

Provides an audible tone for up to 12 seconds when held.



### **L** LED LOCATE LIGHT

Uses a LED Light on the receiver to locate your dog in the dark. For continuous blinking, every 4 seconds, tap the Locate Light button once. To disable the continuous blinking, tap the Locate Light button again. To manually enable the continuous blinking, press and hold the Locate Light button which can stay blinking for up to 12 seconds.

### 3. TRANSMITTER BUTTON ASSIGNMENT (UP TO 4 RECEIVERS)



The buttons on the front of the transmitter enable control of up to 4 receivers. Each of the 4 buttons on the transmitter can be coded to operate a different receiver. The receivers can be distinguished by coding the transmitter button to the matching receiver strap color.

## 4. CHANGING THE STIMULATION DIAL



EDGE2 has the ability to switch between the Rheostat Dial and the Selector Dial. The EDGE2 unit comes installed with the Rheostat Dial. To switch to the Selector Dial, follow the steps below.

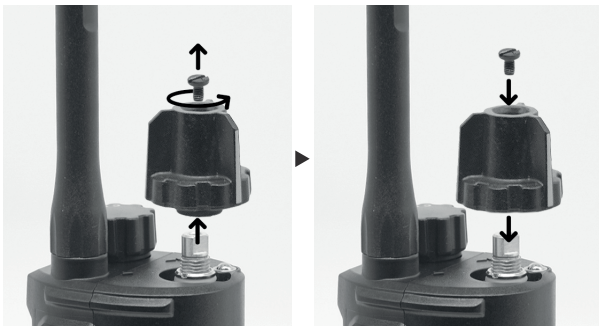

1. Turn the stimulation level to 0.
2. Unscrew the top of the dial with a flathead screwdriver counterclockwise.
3. Remove the current dial knob and replace with the desired dial knob.
4. While firmly holding the dial knob in place, tighten the screw clockwise.

***Next, change the program setting to the corresponding dial knob.***

## Change the program setting

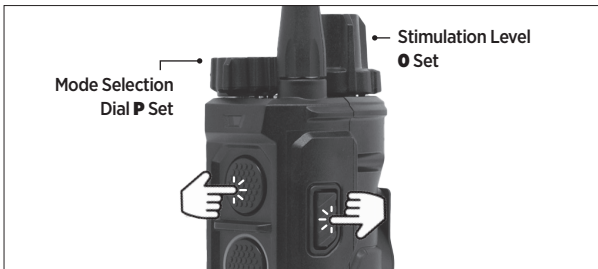

1. Set the transmitter's stimulation dial to "0" and the mode selection dial to "P".
2. Simultaneously hold down the top button on the front of the transmitter and the on/off button on the top right of the transmitter.
3. The LCD screen will display the rheostat dial or selector dial icon, and the Stimulation Level indicator location will change. After being displayed for about 1 second, the change is complete when "P-" is shown on the switch. To switch between the rheostat dial and the selector dial, repeat the steps from the beginning.

### Selector Dial

0-10 Level

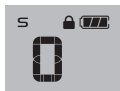

1 second later

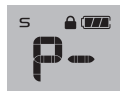

### Rheostat Dial

0-127 Level

**Default**



1 second later



## Stimulation Type Level Comparison

	<b>R</b> RHEOSTAT DIAL 0 - 127 Level	<b>S</b> SELECTOR DIAL 0 - 10 Level
Max	<b>127</b>	<b>10</b>
	<b>105</b>	<b>9</b>
	<b>92</b>	<b>8</b>
	<b>81</b>	<b>7</b>
	<b>68</b>	<b>6</b>
	<b>59</b>	<b>5</b>
	<b>48</b>	<b>4</b>
	<b>40</b>	<b>3</b>
	<b>27</b>	<b>2</b>
	<b>11</b>	<b>1</b>
Min.	<b>0</b>	<b>0</b>

## 5. SAFETY LEVEL LOCK



To lock in a chosen stimulation level tap the On/Off button once you have selected your chosen level. The lock icon will appear on the LCD screen indicating the selected stimulation level is locked in place to prevent any level changes. To unlock the stimulation level tap the on/off button to release the stimulation lock.

## 6. HOW TO ADD AN ADDITIONAL RECEIVER DEVICE



1. Turn on the transmitter by pressing and holding the power button on the top right of the transmitter.
2. Set the transmitter's stimulation dial to "0" and the mode selection dial to "C".



3. With the receiver turned off, hold down the on/off button on the receiver until the LED light begins to rapidly blink green.



4. While the green LED is rapidly blinking on the receiver, press the button on the transmitter of the color you would like to code the receiver to. The LED light on the receiver will blink every 4 seconds when coding is complete.

**Repeat the pairing process if the pager vibration test is unsuccessful.  
The pairing between the devices has timed out or failed.**

CD\*\*\*\* : Product ID CODE

# HOW TO USE THE RECEIVER

## 1. RECEIVER FITTING

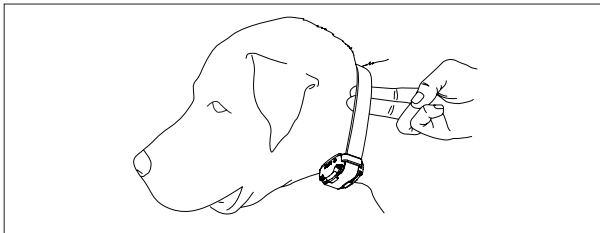

### **Improper Fit**

A loose fit can allow the receiver to move around on the dog's neck. When this happens, the contact points may rub against the skin and cause irritation. If the receiver is too loose, the contact will not be consistent and cause the corrections to be inconsistent. Dogtra uses medical grade stainless steel contact points and anti-microbial plastic to protect the dog's skin.

### **Proper Fit**

The receiver should be fitted so that the anti-microbial plastic contact points press firmly against the dog's skin. You should be able to fit two fingers underneath the collar strap. The Best location is on either side of the dog's windpipe.

### **Attention!**

Leaving the receiver in the same location on the dog's neck for an extended period of time can cause skin irritation due to the sensitivity from the contact points. If the dog is to wear the receiver for long periods, occasionally reposition the receiver every few hours so that the contact points are moved to a different location on the dog's neck and remove the receiver after 8 hours of usage. Make sure you check for skin irritation each time you use the unit.

## 2. HOW TO INSERT THE STRAP

### STEP 1

Insert the strap by looking at the direction of the arrow on the receiver.

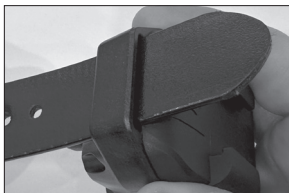
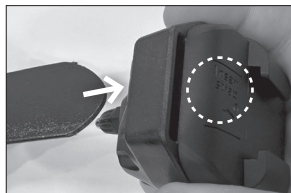

### STEP 2

Make sure to connect the middle groove of the receiver.

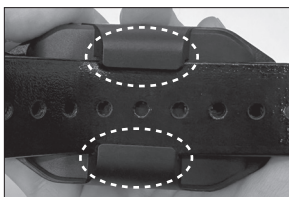
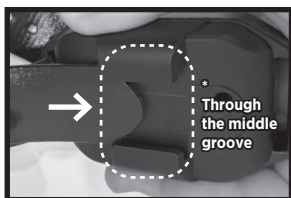

### STEP 3

Attach the receiver to the strap by threading the strap through the opposite hole.

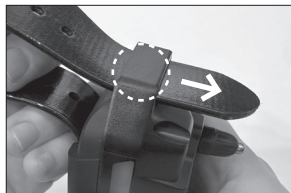

### 3. OBTAINING MAXIMUM DISTANCE

The operating range of the EDGE2 is 1.2 miles.

Depending on how you use the transmitter, the range of your transmitter may vary. For maximum range, hold the transmitter away from your body and avoid touching the antenna. Charge your device properly to maximize signal strength.

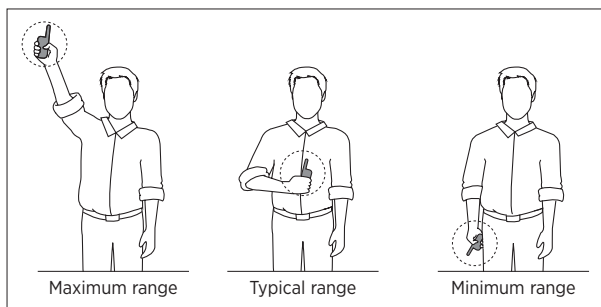

The range is reduced when the handheld transmitter's antenna is covered or in contact with your body. Refer to the following carrying methods for optimal range.

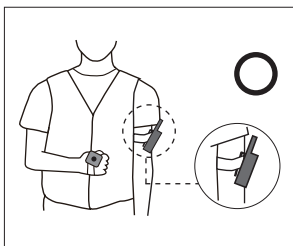
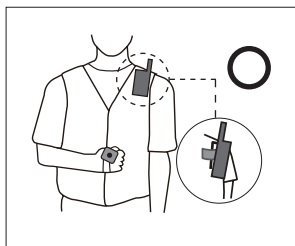

Carry the handheld transmitter with the antenna facing away from you.

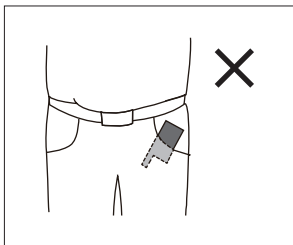
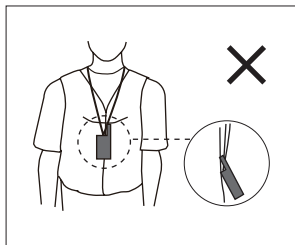

Do not place the handheld transmitter with the antenna touching your body or facing downwards.

#### 4. FINDING THE RIGHT STIMULATION LEVEL

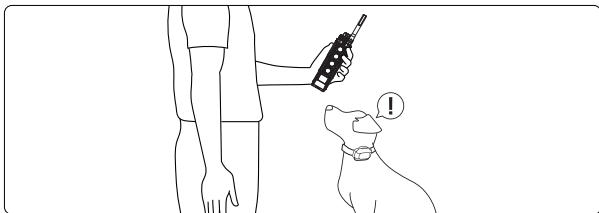

The EDGE2 has a rheostat dial on the top of the transmitter. Always start at the lowest level and work your way up. You will find the right level when your dog responds to the stimulus with a mild response. You may also need to adjust intensity levels as your dog's demeanor changes, especially during times of increased excitement or distraction.

## 5. NON-STIMULATION CONTACTS



1. Please turn the contact points counter-clockwise to remove them.



2. Place non-stimulation contacts in each place



3. Press non-stimulation contacts to secure the non-stimulation contacts

## 6. LED INDICATOR

The LED indicator flashes every 4 seconds when the receiver is on and ready for use. The LED indicator will blink on both the transmitter and the receiver when the transmitter buttons are pressed.

The LED indicator color indicates the battery life level.

**Green = Full charge**

**Amber = Medium charge**

**Red = Needs charge**

If the unit is used while the LED indicator is red, it may shut down automatically.



### Receiver Indicator Light

When the Constant button on the transmitter is pressed, the receiver indicator light will glow steadily (either green, amber, or red based on the remaining battery life), as long as you hold the button down, for up to 12 seconds. When the Nick button is pressed, the light comes on for a fraction of a second.

## 7. CHANGING THE LOCATE LED LIGHT COLOR

Locate LED Light can be set to any of the 4 colors available. To change the receiver location light to white, red, green, or blue, follow the instructions below.



1. Start with the receiver turned off.
2. Hold down the on/off button on the receiver for 10 seconds.  
\* **The on/off button must be pressed for a full 10 seconds.**
3. Release the on/off button after the white location light flashes rapidly. The white location light will start flashing after the single green (small) LED indicator code setting light finishes blinking.
4. Press the on/off button once to set the desired color.

### NOTE:

- The location light colors will rotate in the order of **white, red, green, and blue** for two full rotations.
- The location light color will reset to the corresponding color when re-coded to another button.

## **8. CARE FOR LCD TRANSMITTERS IN COLD TEMPERATURE**

In cold temperatures (below 10°F), the transmitter's liquid crystal display (LCD) may appear dim or unresponsive. Wait until you see the display before selecting your training level. Even if the LCD screen goes dark or becomes unresponsive when you press a button, the transmitter still functions properly. In very cold weather, the LCD screen may take some time to respond, which may cause the intensity level to become stuck at the current level. Turning the rheostat dial will not change the level on the screen, but will change the actual intensity of the receiver.

## 9. BATTERY CHARGE

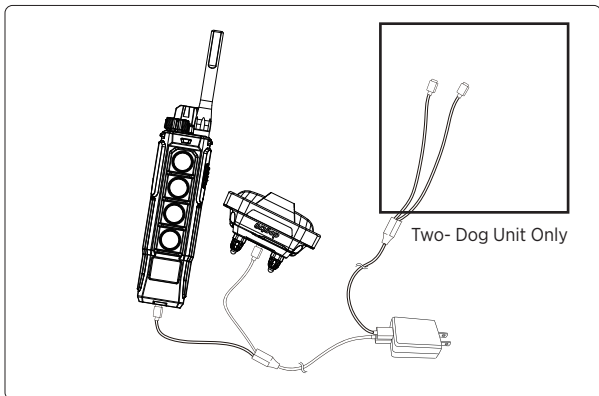

Dogtra EDGE2 uses a lithium polymer battery. If the light is red, the device does not turn on, or the system does not stay on when you press the button, recharge the device.

**Note 1:** Use only Dogtra approved batteries, chargers and accessories with the Dogtra e-collar. This will prevent any damage that may occur if you try to use a different charger.

**Note 2:** The device will be partially charged when leaving the Dogtra facility. When you receive the system, be sure to give it an initial charge of 2 hours before using it for the first time in an area away from flammable materials.

**Note 3:** When the charger is not in use, unplug it from the power source. If the device will be stored unused for more than 3 months, fully charge the battery.

### **To charge your system, follow the steps below:**

1. Open the rubber plug on the battery charging port and connect the charging cable.
2. Plug the charger into a 120-volt wall outlet (Use a 220-volt European charger for Europe). If charging in the vehicle, use a USB AtoC or USB CtoC cable to charge, depending on the type of port available. All indicator lights should glow red when properly connected, and the unit will automatically shut off during the charging process. Once the unit is fully charged and unplugged from the charging cable, you will need to turn the unit on again before use.
3. The lithium polymer battery is fully charged within 2 hours. The light stays red while charging and turns green when the device is fully charged.
4. After charging, cover the battery charging port with a rubber plug.

### **Recharging is required in the following cases:**

- The LED on the transmitter or receiver is red.
- The LED on the transmitter or receiver does not light.
- A low-battery sound occurs when the transmitter or receiver is powered off.

### **Charger Info**

Manufacturer: E-SUN

Manufacturing country: CHINA

Model name: MKC-0502500VT

INPUT: 100-240V-50/60Hz 0.4A

OUTPUT: 5V 2500mA

## 10. ATTACHING THE BELT CLIP

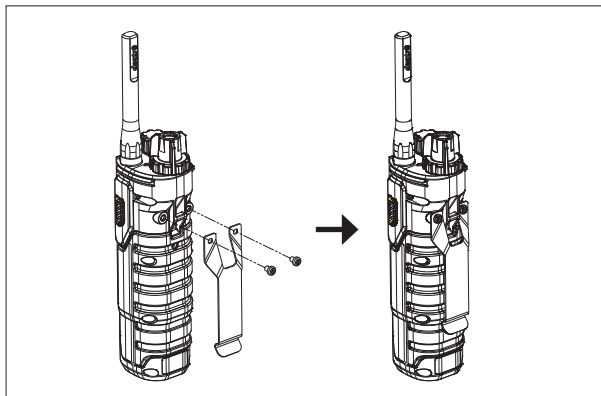

To attach the included belt clip, follow the instructions below.

1. Align the belt clip with the grooves on the back of the transmitter.
2. Use a screwdriver to firmly tighten the screws of the belt clip.

### **Caution**

Firmly tighten both screws of the belt clip. Be careful not to overtighten.

## 11. USING THE TEST LIGHT



1. Turn on the receiver by pressing and holding the on/off button in the center of the contact terminal. The receiver's light will briefly turn on and then blink once every 4 seconds to indicate that the receiver is ready to use (if the light is red, the receiver needs to be charged).
2. Turn on the transmitter by pressing and holding the on/off button on the right side of the transmitter. The LED blinks every 4 seconds and the remaining battery life is displayed on the LCD screen (If the battery icon on the LCD transmitter screen shows only 1 bar, it needs to be charged).
3. Place the test light included in the package onto the contact points as shown.
4. Press the Nick button on the transmitter and observe the test light. It should only be on for a moment (The higher the intensity, the brighter the test light).
5. Observe the test light while pressing the Constant button on the transmitter. The button should light up as long as you hold it down. However, as a safety feature, if you press the Constant button for more

than 12 seconds, the receiver will automatically stop stimulation.

6. Turn the rheostat dial on the transmitter clockwise and then counterclockwise. The test light shines brighter at higher stimulus levels and dimmer at lower levels.

**Note:** The test light may not be visible if the intensity level is set below level ten.

# GENERAL TRAINING TIPS

Your dog must know some basic obedience commands before beginning training with the EDGE2. A dog learns by first being shown a command, followed by lots of repetition over an extended period. As the dog becomes proficient at these commands, the trainer can introduce distractions and different locations to strengthen the commands.

## **Obedience Training on the Leash**

Your dog must fully understand the obedience commands (sit, stay, here, heel, and kennel) before using the e-collar for reinforcement of these commands. A leash attached to a standard collar is used to "teach" the dog the basic obedience commands (sit, stay, here, heel, and kennel). A tug on the leash/collar is used to reinforce the command. When the dog complies with the command, use positive reinforcement/praise. Once the dog understands these commands, the e-collar can be used to reinforce them.

## **Beginning E-Collar Training**

When you feel your dog understands the obedience commands on the leash we can now start with the e-collar training. With the dog on the leash and wearing the e-collar, continue with your obedience drills. Apply light stimulation (Nick or Constant) when a command is given; the stimulation can be removed as the dog complies. Through repetition, the dog learns to perform the command.

The final step is the avoidance phase in which the dog learns that he can avoid the stimulation altogether by performing your commands. When these training procedures are complete, the e-collar is used as a reminder when the dog does not comply with your

commands at home or in the field. Keep your initial training sessions short and positive as dogs have a short attention span.

### **How Much Stimulation to Use**

Always start with low levels of stimulation and work your way up depending on the disposition of your dog and the given situation. By using the correct amount of stimulation to get your point across, you will have a more controllable environment and a dog that is under less stress. Animals (and humans) perform better in a less stressful environment.

**For more training information, please visit our website at [www.dogtra.com](http://www.dogtra.com).**

# MAINTENANCE

## **Basic Maintenance**

Make sure the rubber charging cap is securely in place when the system is in use. After each training session, carefully inspect the unit for any missing parts or damage to the casing. Damaged or broken casing may affect the waterproof guarantee on the unit. After confirming that there is no damage to the casing, rinse the receiver and clean out any dirt or debris.

## **Storage Maintenance**

The unit should be fully charged before storing for extended periods. While in storage, the unit should be given a full charge once a month and before the first use. Store the units in at room temperature. Do not keep the units exposed to extreme climates.

## **Troubleshooting**

If the unit is malfunctioning, please refer to the “Troubleshooting Guide” before sending it to Dogtra for service. If you have any questions or concerns, you may email them to [Info@dogtra.com](mailto:Info@dogtra.com), or call customer service at 1 (888) 811-9111.

# TROUBLESHOOTING GUIDE

## **1. My dog is not reacting to the system.**

- Make sure the receiver and transmitter are on.
- Make sure the collar strap is tight enough so both contact points are touching the dog's skin.
- The contact points may be too short for your dog's thick or long coat. You might need to trim down the hair on the dog's neck, so both contact points are touching the skin.
- The intensity level may be too low for your dog. Keep increasing the stimulation until the dog responds usually by neck movement, head shaking, looking over his shoulder, etc. (response may be very subtle so pay attention).

## **2. The LED indicator light comes on, but I do not feel any stimulation.**

- The battery may be low, so check the LED light for battery life.

## **3. The transmitter has no range or stimulation is less when the dog is farther away.**

- The antenna(s) may be damaged. To order parts, please contact customer service at (888) 811-9111 or go to [www.dogtra.com](http://www.dogtra.com).
- The range indicated on the unit's box is for flat terrain. Heavy brush, trees, hills, or moisture will affect the range of your unit. For best range, hold the transmitter vertically above your head, and/or try moving to higher ground.
- Any electrical conductors will affect the range, such as cars, chain-link dog runs, metal structures, and radio towers. For best results, operate away from these objects.

#### **4. My units are not holding a charge.**

- The batteries might not be charged properly, or the charger, splitter, and the charging port may not be functioning properly. You can send in your charging units to have us inspect them.
- The charging pin may be damaged. Inside the charging port, there is a metal pin that should be standing straight up and stiff. If the pin is wobbling, broken, or missing, you will need to send the unit in to the Repair Department. The charging port must be clean prior to charging; clean the dirt out with a cotton swab and some rubbing alcohol. If the dog is in saltwater, be sure to rinse the receiver and charging port with clean water.
- If the above does not resolve your issues, contact Dogtra customer service at [info@dogtra.com](mailto:info@dogtra.com) or (888) 811-9111.

#### **5. My dog has skin irritation.**

- This may be due to an improper fit or from wearing the unit too long. If your dog exhibits signs of skin irritation, consult with a veterinarian. Once the dog's skin returns to a normal condition, continue to use the receiver and check your dog's neck each time you use the unit.

# FCC/ISED WARNING STATEMENT

## **PART 15.19**

This device complies with Part 15 of the FCC Rules. Operation is subject to the following two conditions:

- (1) This device may not cause harmful interference, and
- (2) this device must accept any interference received, including interference that may cause undesired operation

## **PART 15.21**

Any changes or modifications (including the antennas) to this device that are not expressly approved by the manufacturer may void the user's authority to operate the equipment under FCC Rules.

## **PART 15.105**

**Note:** This equipment has been tested and found to comply with the limits for a Class B digital device, pursuant to part 15 of the FCC Rules. These limits are designed to provide reasonable protection against harmful interference in a residential installation. This equipment generates, uses and can radiate radio frequency energy and, if not installed and used in accordance with the instructions, may cause harmful interference to radio communications. However, there is no guarantee that interference will not occur in a particular installation. If this equipment does cause harmful interference to radio or television reception, which can be determined by turning the equipment off and on, the user is encouraged to try to correct the interference by one or more of the following measures:

- Reorient or relocate the receiving antenna.
- Increase the separation between the equipment and receiver.
- Connect the equipment into an outlet on a circuit different from that to which the receiver is connected.
- Consult the dealer or an experienced radio/TV technician for help.

This device contains license-exempt transmitter(s)/receiver(s) that comply with Innovation, Science and Economic Development Canada's license-exempt RSS(s). Operation is subject to the following two conditions:

- (1) This device may not cause interference.
- (2) This device must accept any interference, including interference that may cause undesired operation of the device.

FCC and IC RF Radiation Exposure Statement: This equipment complies with FCC and IC RF Radiation exposure limits set forth for an uncontrolled environment.

This device and its antenna must not be co-located or operating in conjunction with any other antenna or transmitter.

# DOGTRA PRODUCT WARRANTY

## LIMITED WARRANTY

### For Dogtra Products Purchased from Dogtra Authorized Dealers

#### One-Year Warranty

Except as otherwise provided below, Dogtra warrants to the original retail purchaser (“You”) that its Dogtra products shall be free of defects in materials and workmanship for a period of one (1) year from the date of purchase (“Warranty”). The Warranty covers the cost of repair (parts and labor) or replacement (if repair is not feasible) of a defective Dogtra product during said one-year period. For such repaired or replaced products, the remaining portion of the original warranty period, or ninety (90) days, whichever is longer, shall apply. Dogtra, at its sole discretion, shall determine whether to repair or replace a product covered by the Warranty.

#### Warranty Conditions

The Warranty is not transferrable and applies to your Dogtra product only if:

- (1) You are the original retail purchaser of the product,
- (2) You bought the product from a Dogtra authorized dealer, and
- (3) You present a receipt or other proof of purchase showing a valid purchase date, the name and address of the authorized dealer, and the purchased product identified by model and/or serial number.

#### Warranty Exclusions

The Warranty does not cover damage, loss, or deterioration to your Dogtra product caused: by misuse, neglect, abuse, or other improper handling of the product; by failure to follow use or care instructions; by use of the product for other than its intended purpose; by accident or natural forces such as fire or flooding; or by normal wear and tear such as scratches to the product surface.

The Warranty also does not cover Dogtra products that: are purchased from non-authorized dealers; are purchased outside of the United States or Canada; have been damaged during shipment (even if Dogtra paid or arranged for shipping); have been modified or tampered with in any manner; are opened or repaired by anyone other than Dogtra; or have serial numbers that have been altered or defaced.

#### Sole Warranty

This Warranty is the only warranty offered by Dogtra for its Dogtra products. Other than said Warranty, Dogtra makes no other representations or warranties whatsoever regarding its products, whether oral or in any

product manual, on any packaging, on any website, or in any other written material. No dealer of Dogtra products, nor any employee or agent of Dogtra, is authorized to make any additions, changes, or extensions to the Warranty. Dogtra, at its sole discretion and at any time, reserves the right to modify the Warranty.

## **DISCLAIMER OF OTHER WARRANTIES**

**THE FOREGOING WARRANTY IS PROVIDED IN LIEU OF ALL OTHER WARRANTIES, WHETHER EXPRESS OR IMPLIED. DOGTRA DISCLAIMS ANY IMPLIED WARRANTIES INCLUDING, BUT NOT LIMITED TO, THE IMPLIED WARRANTIES OF MERCHANTABILITY AND FITNESS FOR A PARTICULAR PURPOSE.**

### **Limitation of Remedies**

Dogtra's liability is limited to the cost of repair or replacement of the Dogtra product under Warranty. Any claim or action to enforce the Warranty must be commenced within thirty (30) days of the Warranty's expiration for your product. Dogtra will not be liable for any indirect, incidental, special, consequential, or similar damages based on breach of warranty, breach of contract, negligence, strict tort, or any other legal theory related to Dogtra and its products. Damages that Dogtra will not be responsible for include, but are not limited to: loss of income or profits; loss of revenue or savings; loss of use of the product or associated products; cost of any substitute products or services; inconvenience, downtime, or any other time; loss of goodwill; claims of third parties including customers; and damage to property.

### **Legal Rights May Vary By State or Jurisdiction**

The Warranty gives You specific legal rights, and You may also have other rights which vary by state or jurisdiction. Some states or jurisdictions do not allow certain limitations of implied warranties or of incidental or consequential damages or other remedies, so certain of the foregoing limitations may not apply to You.

If any portion of the Warranty is held by a court to be invalid or unenforceable, the remaining portions of the Warranty shall remain in full force and effect and shall in no way be affected or invalidated, and the invalid or unenforceable portion shall be modified so as to most nearly achieve the intent of the Warranty.

### **Product Registration**

Dogtra recommends that customers register their products as soon as possible after purchase. Product registration will facilitate any future warranty service. You may also receive useful information and updates

about your existing and future Dogtra products. To register your product, visit [\*\*www.dogtra.com/product-registration\*\*](http://www.dogtra.com/product-registration). If your product is not registered with Dogtra, You will be required to provide a receipt or other proof of purchase (as provided above) to qualify for warranty service.

### **How to Obtain Warranty Service**

Should your Dogtra product require warranty service, please contact Customer Service by phone or email for a warranty evaluation (see below for contact information). Upon approval of your warranty work, Dogtra will repair or replace (at Dogtra's election) your product without charge for labor or parts. You are responsible for shipping your product to Dogtra for warranty service, including the cost of shipping. Dogtra will handle shipping, including cost, of the repaired or replaced product back to customers in the USA. Dogtra will not be responsible for shipping, including cost and/or applicable taxes or fees, for products sent to Canada. Such costs, taxes, or fees will be borne by the customer.

To register your product, visit [\*\*www.dogtra.com/product-registration\*\*](http://www.dogtra.com/product-registration).

### **Dogtra Customer Service**

12322 Monarch Street, Garden Grove, CA 92841

(888) 811-9111

repair@dogtra.com

Mon – Fri, 8:00 AM to 4:30 PM (PST)

© 2026 Dogtra. All rights reserved.