



OWNERS MANUAL

WITH BASIC TRAINING GUIDE

FOR G3[®]EXP[®]
FIELD, PRO &
SPORT SERIES



TRI-TRONICS[®]

VISIT GUNDOGSUPPLY.COM
ORDER TRI-TRONICS G3 FIELD AND PRO COLLARS
SEE OTHER TRI-TRONICS PRODUCTS

Rugged. Reliable. Proven.

The Leader in Electronic Dog Training Equipment for over 40 years.

Tri-Tronics® Owners Guide

Sport, Field & Pro G3® Series Remote Trainers

Congratulations on your purchase!

All Tri-Tronics Remote Trainers are proudly made in the USA.

Tri-Tronics takes great pride in the design, manufacture, service and safety of all our products. We always want to hear from you, our customer.

You can contact us and get the latest information available regarding your product, our support services, training information, or to purchase accessories, collars, or additional receivers for your Tri-Tronics Remote Trainer.

We can be reached via email at support@tritronics.com
or by calling toll free 1-800-456-4343 or
visit our website at www.tritronics.com.

Thank you for choosing Tri-Tronics.

Models Covered

Classic 70 G3®, Classic 70 G3®EXP®, Field 90 G3®EXP®, Flyway G3®EXP®, Upland Special G3®EXP®,
Trashbreaker G3®EXP®, Pro 100 G3®EXP®, Pro 200 G3®EXP®, Pro 500 G3®EXP®,
Sport Basic G3®, Sport Combo G3®, Sport Upland G3®.

Tracer, Sport Upland, Classic 70, Field 90, Flyway, Trashbreaker, Upland Special, Pro 100, Pro 200,
and Pro 500 are all trademarks of Tri-Tronics, Inc.

Tri-Tronics, Remote Trainer, Sport, Sport Basic, Sport Combo, G2, G3, and EXP are all registered trademarks of Tri-Tronics, Inc.

Product Specifications

Product specifications and features may change at any time without notice or obligation since Tri-Tronics® is committed to a policy of continuous improvement.

Tri-Tronics Patents

Certain Tri-Tronics® products are covered by one or more of these U.S. patent numbers: 4794402, 4802482, 5054428, 5099797, 5193484, 4947795, D410206, 6170439B1, D445706S, D446144S, 6549133, D445707S, 6750758, 6907844, 7000570, 6928958, 7187291, 7198009, 7252051, D520894, D531584, D553037, and patents pending.

Canada patent numbers: D 105795, 2456603, 2456431, 2456876, 2456852, 2456425, 2456433, 2456879

Owner's Registration Reply Card

Please take a moment to complete and return the Owner's Registration Reply Card. When you do, you'll be "on file" at Tri-Tronics®. This will help ensure timely warranty work should you need it. You may also register on our website at www.tritronics.com.

Second Edition, December, 2008

Published by Tri-Tronics®, Inc., Tucson, Arizona

Copyright © 2008 Tri-Tronics®, Inc.

All rights reserved. Printed in the USA.

TABLE OF CONTENTS

MODEL GUIDE – Field & Pro G3 Series	1-18
MODEL GUIDE – Sport G3 Series	19-22
SETTING UP A MULTI-DOG SYSTEM	23-25
CHARGING THE BATTERIES	26-28
FITTING THE COLLAR ON THE DOG	29
STIMULATION OVERVIEW	30
STIMULATION - CONTINUOUS & MOMENTARY	31
RANGE	31
TRI-TRONICS BEEPER	32-36
REPLACING BATTERIES	37
CARE AND CLEANING	38
RADIO SIGNAL ISSUES	38
FCC COMPLIANCE	38
TROUBLESHOOTING GUIDE	39-43
BASIC TRAINING INTRODUCTION	44
E-COLLAR BASICS	44
BASIC TRAINING	45-48

MODEL GUIDE – Field & Pro G3® Series

The following pages illustrate the detail for operation of the Field and Pro series G3® remote trainers. All Field and Pro Series G3® EXP® models can grow with your needs to train multiple dogs because you can simply add more receivers to your system (see pages 23-24). The Classic 70 standard model cannot be expanded and has no dog selection switch but has the other appropriate features.

Transmitter

Antenna

Permanent, non-removable One-mile range; Two miles on Trashbreaker*

*Range depends on terrain, weather, vegetation, other radio transmissions in the area, and other factors. For best range, hold the Transmitter overhead with the antenna pointed upward while transmitting and keep your fingers off the antenna.

Tone or Beeper Control Button

Activates the no-stimulation signal tone of the following models: Field 90 G3® EXP®, Flyway G3® EXP®, Pro 100 G3® EXP®, Pro 200 G3® EXP®, and Pro 500 G3 EXP®. Switches Beeper on and off on the Upland Special and controls the Tracer™ light settings.

Note: Tone on the Classic 70, Trashbreaker, and Upland Special is activated by pressing any stimulation button when the Intensity Dial is set on "T."

Charging

The supplied charging adaptor is fitted onto the transmitter. There will be a positive "snap" feel when the Transmitter locks into the adaptor correctly.

To remove the adaptor push down on the removal tab at the back of the adaptor.

Battery Compartment Door For Replacing Battery Pack Only

(Note: Open only for changing batteries as the battery pack does not need to be removed for charging.)

Charging Contacts (screw heads)

Screw heads must be clean to ensure proper charging.

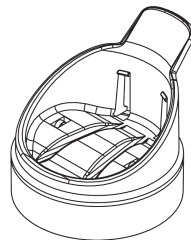
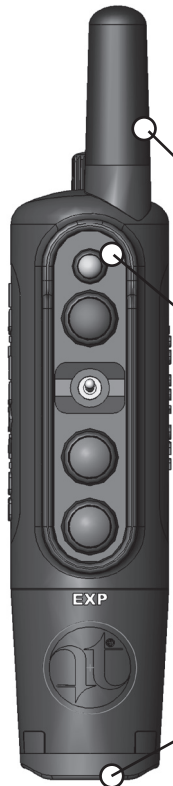

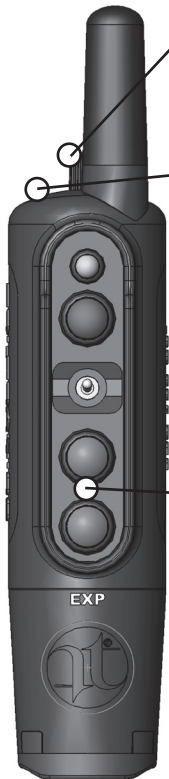

Intensity Dial

Intensity levels: 1, 2, 3, 4, 5, 6

Line up the number you select with the light on the top of the housing.

“N” (neutral) or “T” (tone) setting, depending on model.

“A” is for the Beeper and Tracer™ accessory operation on models other than the Upland.

Dual Function Indicator Light

Battery Life Indicator (“Fuel Gauge”)

When a stimulation button is pressed, this light will be:

- Steady green when the batteries are fully charged.
- Steady amber when the batteries are partly discharged.
- Steady red when the batteries need charging very soon.
- Rapid red flashing means the batteries are completely dead and the transmitter will not operate the collar.

Intensity and Stimulation Indicator

- This light is the position indicator for the selected operational setting or intensity level. It flashes as described above when a stimulation button is activated

Stimulation Buttons

Buttons vary by model. See the “Model Guide” section for detail.

NOTE: CHARGE TRANSMITTER BEFORE FIRST USE.

RECEIVER

A Dual Function Receiver Light

(“Fuel Gauge”)

Collar activation indicator:

- Indicates that the collar is switched on by flashing twice per second with a four second gap between flash sequences.

When a stimulation button is pressed this light indicates battery charge and will be:

- Steady green when the batteries are fully charged
- Steady amber when the batteries are partly discharged.
- Steady red when the batteries need charging very soon.
- Rapid red flashing means the batteries are completely dead and the unit will not function.

(Note: It takes 20 seconds after the collar is switched on for the light to register the battery charge level.)

B Collar Strap Retaining Loops

(“Belt Loops”)

The receiver has three belt loops for secure collar strap attachment and retention with no gap. Do not use the collar strap “belt loops” for attaching a leash. They are not designed for this use.

C Battery Pack Access Screws

Remove these two screws to remove the battery pack for replacement.

Position the new pack in place and replace the screws.

These screws are also removed to install the Tracer™ light accessory.

Very important: Do not remove or tamper with any internal labels that are visible when the battery pack is removed.

Doing so will void your warranty. The receiver product code label is a seal that maintains waterproof integrity of the receiver.

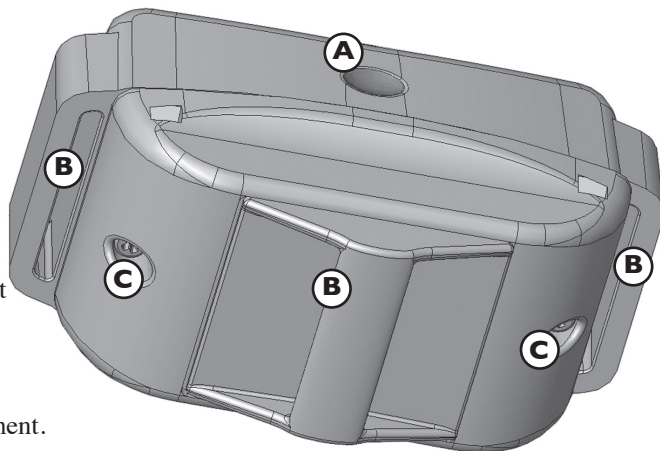

NOTE: CHARGE RECEIVER BEFORE FIRST USE.

D Contact Points

The Tri-Tronics patented insulated contact points ensure consistent stimulation under all conditions.

Choose short or long points to match the dog's coat type. (See the section "Fitting the Collar on the Dog" on page 29.)

E Collar On/Off Button

Press to switch the collar on. Two confirming tones will sound and the collar light will flash periodically while the collar is on. Press to switch the collar off. One long tone will sound and the light will stop flashing. Switch the collar off when not in use to conserve batteries.

F Charging Contacts

Place the receiver in the supplied cradle to charge.

Discharged batteries will take only two hours to fully recharge with the exclusive Tri-Tronics charging system.

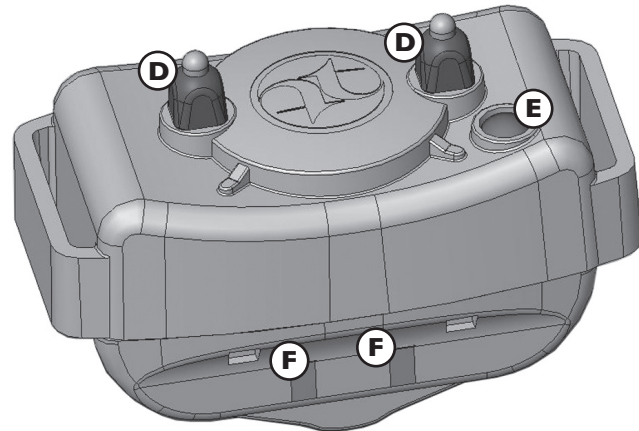

NOTE: CHARGE RECEIVER BEFORE FIRST USE.

CLASSIC 70 & TRASHBREAKER EXP®

Non EXP® 70 G3 has one stimulation button.

-6 levels of continuous stimulation

-Train up to 6 dogs

-1 black collar strap included with system

-Receiver matched at factory to black setting on dog selection switch

-“T” setting on intensity dial for tone.

Set the dial to T and press any stimulation button to produce the tone signal instead of stimulation

-“A” setting on intensity dial for Beeper or Tracer™ accessory

Set the dial to A and press any stimulation button to activate a Tri-Tronics Beeper or Tracer™ accessory if installed

-1 mile range on Classic 70

-2 mile range on Trashbreaker

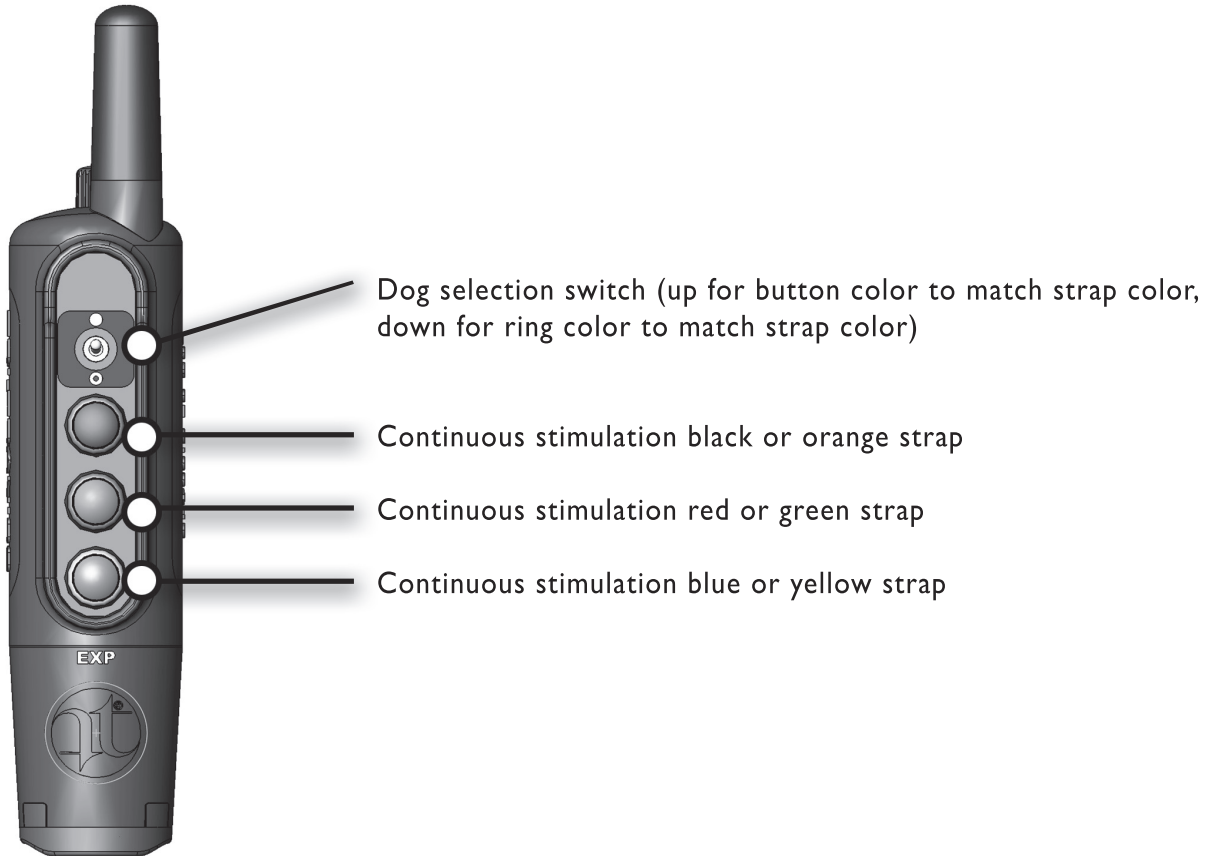

FIELD 90 G3 EXP[®]

- Dedicated tone button
 - 6 levels of medium momentary stimulation
 - 6 levels of high continuous stimulation
 - Train up to 3 dogs
 - 1 black collar strap included with system
 - Receiver matched at factory to black position on dog selection switch
 - “A” setting on intensity dial for Beeper or Tracer[™]
- Set the dial to A and press any stimulation button to activate a Tri-Tronics Beeper or Tracer[™] accessory if installed
- “N” neutral setting on intensity dial - transmitter buttons will not function

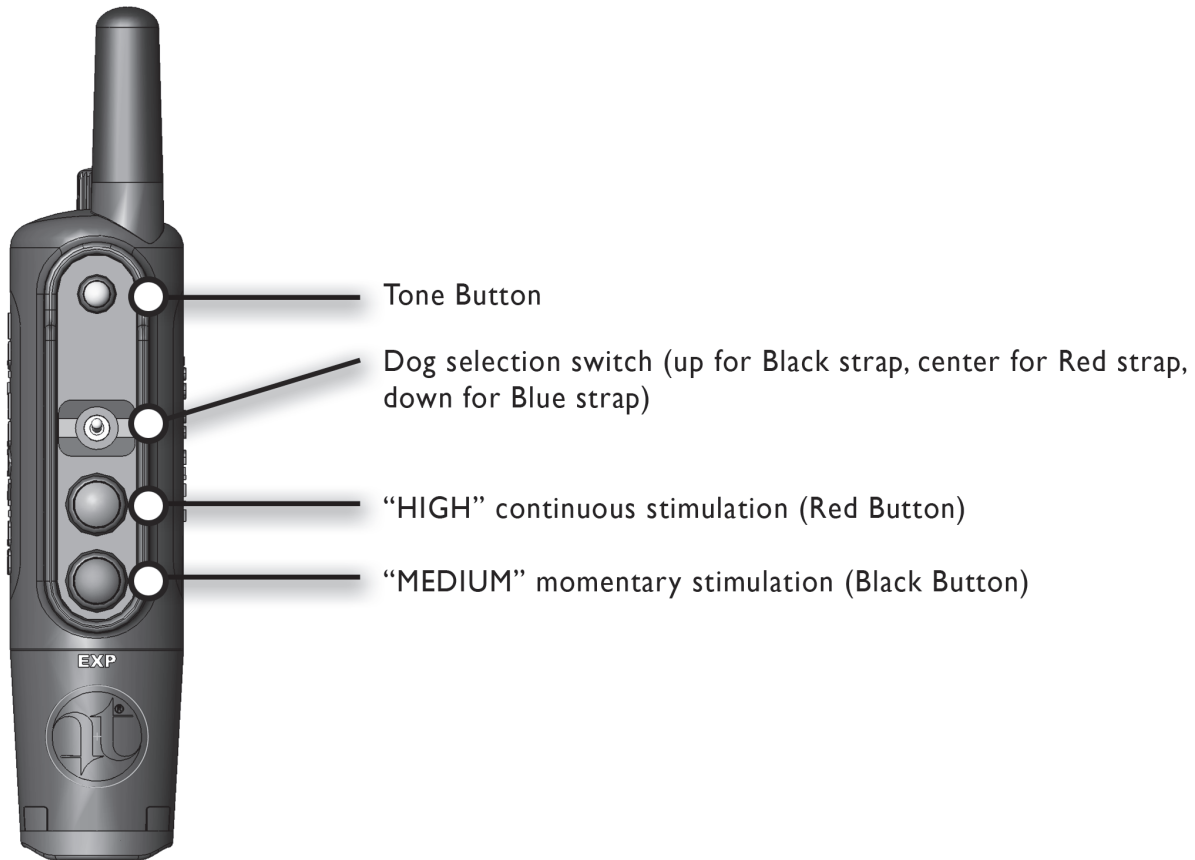

FLYWAY G3 EXP[®]

- Dedicated tone button
- 18 levels of momentary stimulation
 - 6 each of low, medium, and high
- 6 levels of high continuous stimulation
- Train up to 3 dogs
- 1 black collar strap included with system
- Receiver matched at factory to black position on dog selection switch
- “A” setting on intensity dial for Beeper and Tracer[™]
 - Set the dial to A and press any stimulation button to activate a Tri-Tronics Beeper or Tracer[™] if installed
- “N” neutral setting on intensity dial – transmitter buttons will not function

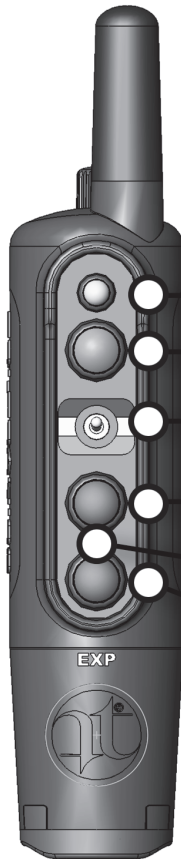

Tone Button

“HIGH” continuous stimulation (Red Button)

Dog selection switch (up for Black strap, center for Tan strap, down for Green strap)

“MEDIUM” momentary stimulation (Black Button)

“HIGH” momentary stimulation
(Both Buttons pressed simultaneous)

“LOW” momentary stimulation (Black Button)

PRO 100 G3 EXP®

- Dedicated tone button
- 18 levels of continuous stimulation
 - 6 each of low, medium, and high
- 6 levels of medium momentary stimulation
- Train up to 3 dogs
- 1 black collar strap included with system
- Receiver matched at factory to black position on dog selection switch
- “A” setting on intensity dial for Beeper and Tracer™
 - Set the dial to A and press any stimulation button to activate a Tri-Tronics Beeper or Tracer™ if installed
- “N” neutral setting on intensity dial – transmitter buttons will not function

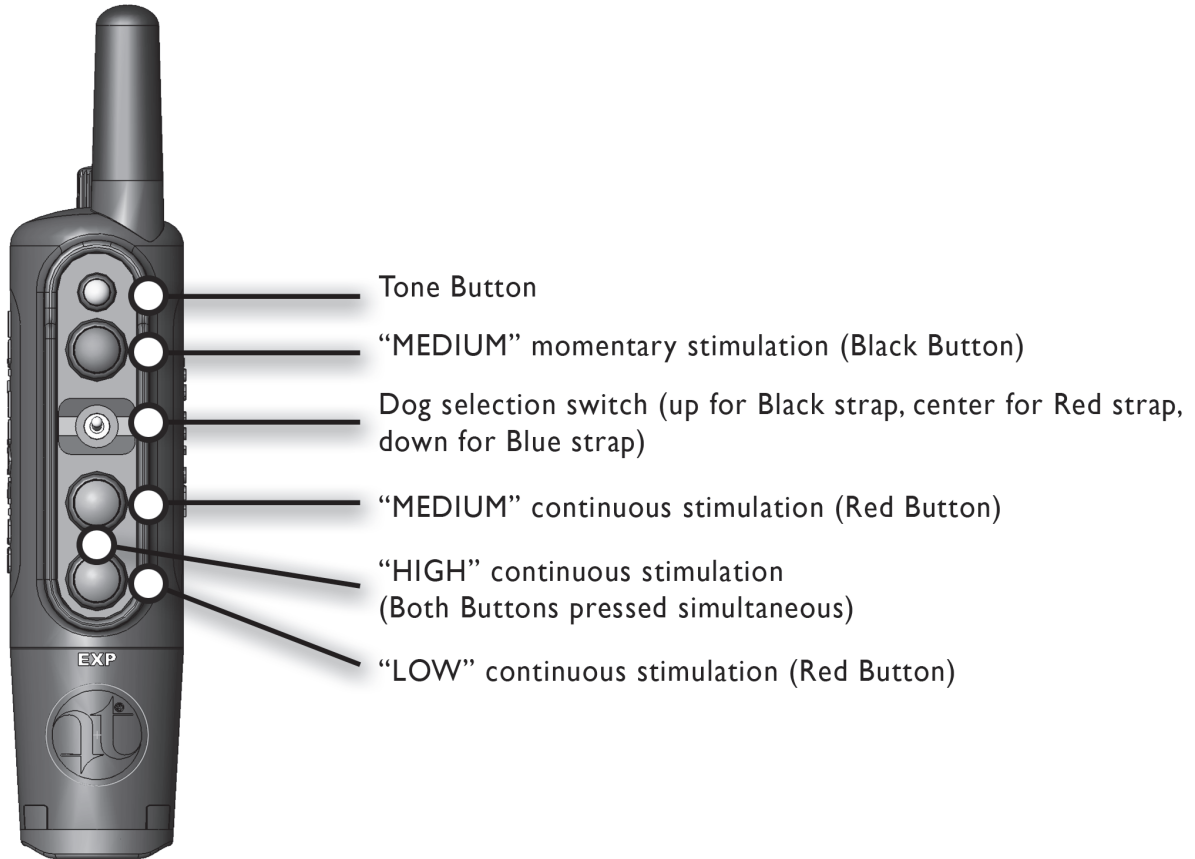

PRO 200 G3 EXP®

- Dedicated tone button
- 18 levels of momentary stimulation
 - 6 each of low, medium, and high
- 6 levels of high continuous stimulation
- Train up to 3 dogs
- 1 black collar strap included with system
- Receiver matched at factory to black position on dog selection switch
- “A” setting on intensity dial for Beeper and Tracer™
 - Set the dial to A and press any stimulation button to activate a Tri-Tronics Beeper or Tracer™ if installed
- “N” neutral setting on intensity dial – transmitter buttons will not function

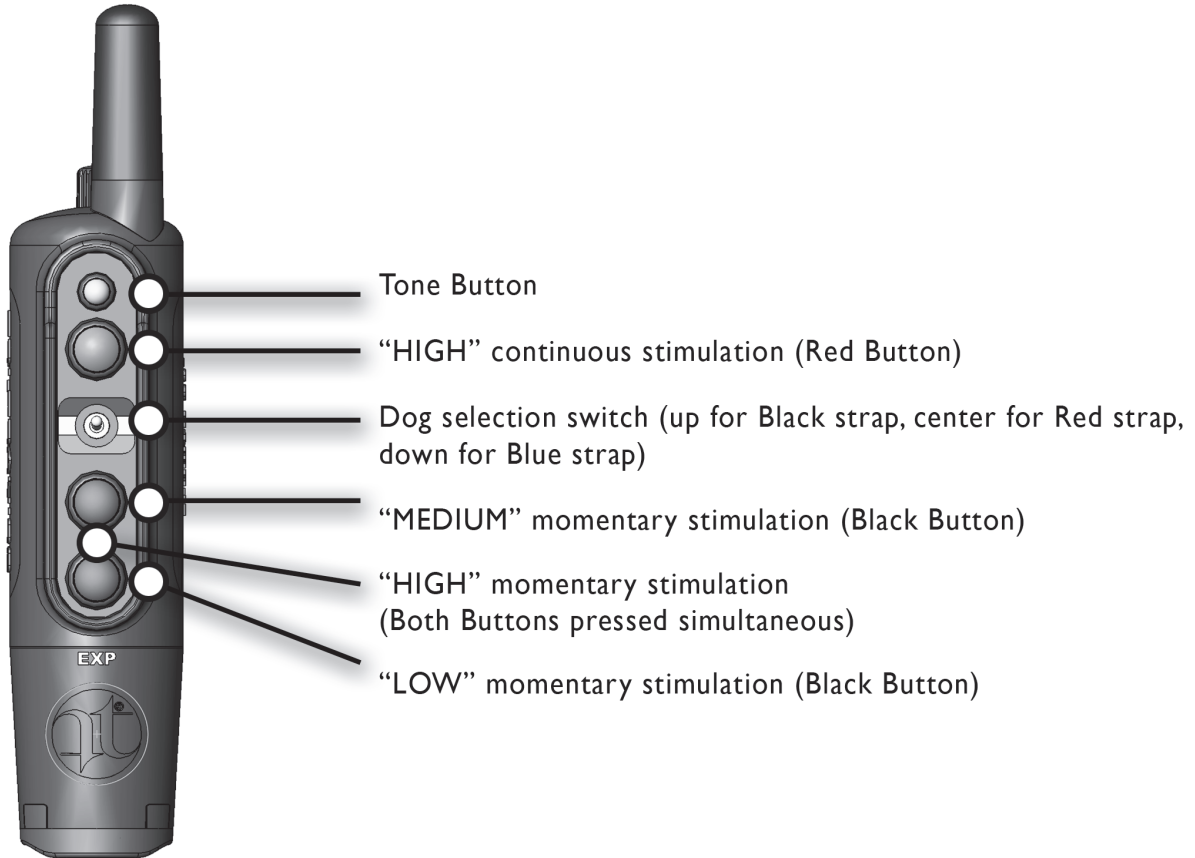

PRO 500 G3 EXP®

- Dedicated tone button
- 18 levels of momentary stimulation
 - 6 each of low, medium, and high
- 18 levels of high continuous stimulation
 - 6 each of low, medium, and high
- Train up to 3 dogs
- 1 black collar strap included with system
- Receiver matched at factory to black position on dog selection switch
- “A” setting on intensity dial for Beeper and Tracer™
 - Set the dial to A and press any stimulation button to activate a Tri-Tronics Beeper or Tracer™ if installed
- “N” neutral setting on intensity dial – transmitter buttons will not function

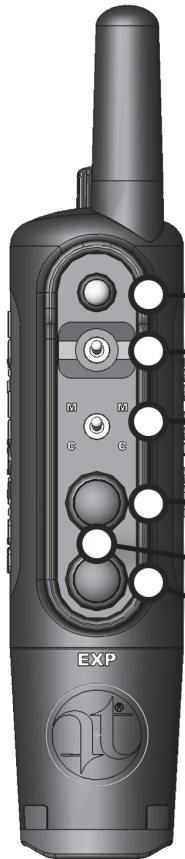

Tone Button

Dog selection switch (up for Black strap, center for Red strap, down for Blue strap)

Mode selection switch (up for momentary, down for continuous)

“MEDIUM” continuous OR momentary stimulation (Black Button)

“HIGH” continuous OR momentary stimulation
(Both Buttons pressed simultaneous)

“LOW” continuous OR momentary stimulation (Black Button)

UPLAND G3 EXP®

- Dedicated tone button
- 18 levels of momentary stimulation
 - 6 each of low, medium, and high
- 6 levels of high continuous stimulation
- Train up to 3 dogs
- 1 orange collar strap included with system
- Receiver matched at factory to orange position on dog selection switch
- “T” setting on intensity dial for Tone
 - Set the dial to T and press any stimulation button to activate a tone signal
- “N” neutral setting on intensity dial – transmitter buttons will not function

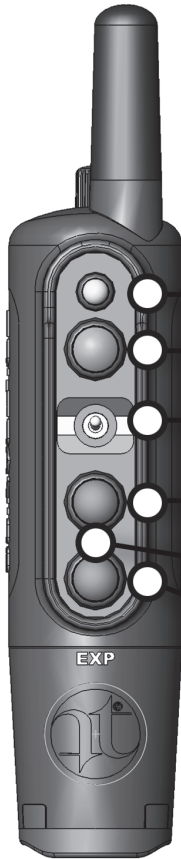

Beeper Control Button

“HIGH” continuous stimulation (Red Button)

Dog selection switch (up for Orange strap, center for Green strap, down for Yellow strap)

“MEDIUM” momentary stimulation (Black Button)

“HIGH” momentary stimulation
(Both Buttons pressed simultaneous)

“LOW” momentary stimulation (Black Button)

MODEL GUIDE – Sport G3 Series

All Sport G3 models can grow with your needs because you can add more receivers to your system (See Setting Up a Multi-Dog System on pages 23-24).

Sport Basic G3

- Top button controls no-stimulation warning buzz.
- Middle button controls continuous stimulation.
- Bottom button controls momentary stimulation.
- Three-way dog selection switch – Black, red, and blue positions. Your transmitter is capable of training up to three dogs with the addition of accessory EXP® receivers (available at www.tritronics.com or 1-800-456-4343).

The black collar strap is included with your original purchase.

Your system will come with the receiver matched to the black position of the dog selection switch.

- 10 levels of continuous stimulation; 10 levels of momentary stimulation.
- “N” (neutral) setting – When the intensity dial is set on “N” transmitter buttons do not function.



Sport Combo G3

- Top button – See mode chart (see chart below)
- Middle button – See mode chart (see chart below)
- Bottom button – See mode chart (see chart below)
- Three-way dog selection switch – Black, red, and blue positions. Your transmitter is capable of training up to three dogs with the addition of accessory EXP® receivers (available at www.tritronics.com or 1-800-456-4343).

The black collar strap is included with your original purchase. Your system will come with the receiver matched to the black position of the dog selection switch.

- Three-way mode selection switch.
- Up to 20 levels of continuous stimulation; up to 20 levels of momentary stimulation
- “N” (neutral) setting – When the intensity dial is set on “N” transmitter buttons do not function

SPORT® COMBO G3 MODE CHART

Mode switch in DOWN position:
Upper button – No-stimulation tone
Middle button – Continuous
Lower button – Momentary

Mode switch in UP position:
Upper button – Momentary
Middle button – Stronger continuous
Lower button – Milder continuous

Mode switch in CENTER position:
Upper button – Continuous
Middle button – Stronger momentary
Lower button – Milder momentary



Sport Upland G3

- Top button controls Beeper.
- Middle button controls continuous stimulation.
- Bottom button controls momentary stimulation.
- Three-way dog selection switch – Orange, green, and yellow positions.
Your transmitter is capable of training up to three dogs with the addition of accessory EXP® receivers (available at www.tritronics.com or 1-800-456-4343).

The orange collar strap is included with your original purchase.

Your system will come with the receiver matched to the orange position of the dog selection switch

- 10 levels of continuous stimulation; 10 levels of momentary stimulation.
- "N" (neutral) setting – When the intensity dial is set on "N" transmitter buttons do not function.



Sport G3 Transmitter

- (A) Permanent non-removable antenna
- (B) Light
- (C) Intensity dial
(10 levels – dots between levels indicate half steps)
- (D) Top button
- (E) Dog selection dial
(Dog 1, 2 or 3)
- (F) Middle button
- (G) Bottom button
- (H) Lanyard attachment point
- (I) Multi-function selection switch

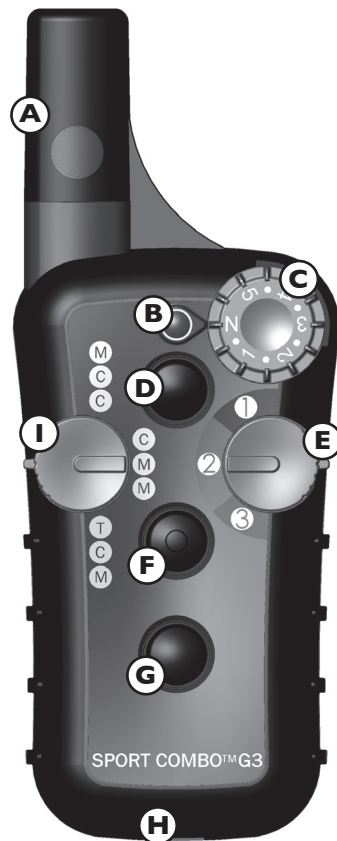

See Model Guide for button function on your model.

SETTING UP A MULTI-DOG SYSTEM

Expandable. All Tri-Tronics Remote Trainers except the Classic 70 standard version are field expandable. This feature makes it possible for you to easily expand your Remote Trainer from a one dog system to a multi-dog system. It also makes it easy for you to replace a lost collar if necessary. Simply purchase additional EXP receivers with collar straps and add them to your system. You can have a multi-dog Remote Trainer when you need one with the simple addition of another receiver at any time. In addition, the Beeper and Tracer light accessories can be added at any time. Additional collar straps in various colors, receivers, and accessories are all available at www.tritronics.com or at 1-800-456-4343.

Collar Straps

A different color strap should be used on each dog so you know which dog will receive stimulation when you press a button. The strap colors match the colors on the dog selection switch on the transmitter. When you purchase a G3 system one strap is included. Most Tri-Tronics Remote Trainers can train up to 3 dogs. The Classic 70 G3 EXP and the Trashbreaker G3 EXP can train up to 6 dogs.

Adding a Receiver

To add an additional receiver to your system, follow these steps.

Please read all steps before starting.

- Fully charge the new receiver.
- Install collar strap of the desired color on the new fully charged receiver.
- Set transmitter dog selection switch to the color of the strap.
- Set transmitter intensity dial to any number or “T” or “A” but not to “N.”
- Switch the receiver on.
- Press and hold receiver on/off button, then press and hold a “continuous” transmitter button. both buttons down for about 5 seconds – until you hear two quick beeps (ignore the long beep that sounds right away). Release both buttons.
- Receiver will now be set to match your transmitter, and will be switched off.
- Check for a successful match by switching receiver back on and pressing a “continuous” transmitter button.

The receiver light will switch on. If you are not planning to use the unit now then switch the receiver off after testing. If the transmitter does not operate the new receiver, follow the procedure again. If you are still having trouble please call our Customer Service Department at 1-800-456-4343.

Special note for Classic 70 G3 EXP or Trashbreaker G3 EXP.

When adding a receiver for dogs 1 – 3, use the button that matches the strap color and place the dog selection switch in the UP position. When adding a receiver for dogs 4 – 6, use the button inside the colored circle that matches the strap color and place the dog selection switch in the DOWN position.

Tone or Buzz Option

You can use your tone or buzz button instead of your continuous button in the above procedure if you prefer.

Moving a Matched Receiver to a Different System

An EXP receiver will remain matched to its transmitter until matched to a different compatible transmitter by following the “Adding a Receiver” steps.

Backwards Compatibility

All G3 transmitter models are backward compatible with all Tri-Tronics receivers that have three belt loops and display the “EXP” symbol on the LED side of the receiver. If you have questions please call our Customer Service Department for advice at 1-800-456-4343.

CHARGING SYSTEMS

Receiver

(Two-Hour Recharge)

The exclusive Tri-Tronics cradle charging system keeps your receiver batteries in better condition than any previous charging system available. Batteries discharged through normal use will take only two hours to fully recharge. Batteries that have been allowed to fully discharge such as in storage for an extended period may take as much as four hours to charge.

The NiMH re-chargeable batteries used in Tri-Tronics products do not have a “memory” so you can recharge at any time, even if the batteries have not run down. Also, you can leave the unit on charge in the cradle at all times when it is not in use and not damage the batteries.

To recharge, plug the supplied wall cube power supply into household AC power and plug the wall cube cord into the charging cradle. Insert the receiver into the cradle so that the receiver charging contacts line up with the cradle charging contacts. There will be a positive “snap” feel when the receiver locks into the cradle correctly. Do not charge batteries in especially hot areas such as inside a vehicle. Keep the vents on both sides of the charging cradle free of dirt and debris. Do not block the vents. Do not wash the charging cradle or allow it to get wet as this will damage it permanently.

Receiver Charging Cradle Light Function

The charging cradle light flashes red and then green briefly when the wall cube is plugged in. When the receiver is charging at full the cradle light will be steady red. When the system switches to trickle charge the cradle light will be steady green. The receiver is now fully charged but may be left on charge. If the cradle light is off this means that power is interrupted, there is no receiver on the cradle, or the receiver is not properly connected.

- A Jack for AC Power Supply** (“Wall Cube”)
Use only the wall cube supplied by Tri-Tronics with the Tri-Tronics receiver charging cradle.

- B Cradle Charging Contacts**

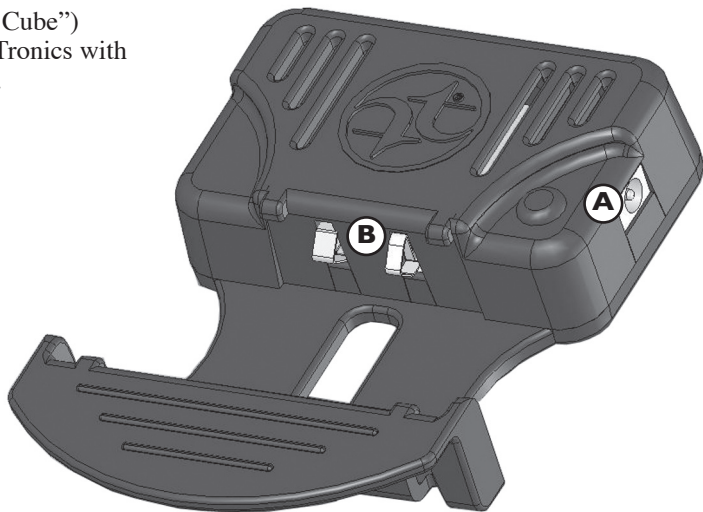

Battery care tips:

- Charge your system regularly.
- Charge depleted batteries promptly.
- Charge batteries at room temperature. Allow cold batteries to reach room temperature before charging.
- If the receiver charging contacts are very dirty, wash the receiver with clean water and dry thoroughly before charging so that good contact with the charger can be made. .
- If the unit is in storage, recharge every four months, and recharge prior to use.

Important:

If the charging cradle light blinks red slowly when the receiver is in the cradle, please consult the troubleshooting guide.

Field and Pro Series G3 Series Transmitters Light Function

Everything said about the receiver charger in the section above also applies to the Field and Pro series transmitter charging adaptor except for the operation of the light. The transmitter charging adaptor does not have a light to indicate charging function. That function is handled by the Field & Pro Series G3 transmitter light when the transmitter is placed on charge. When the transmitter is attached to the adaptor and is charging at full current, the transmitter light will be red. When the system switches to trickle charge, the transmitter light will be green. The transmitter is now fully charged but may be left on charge. If the transmitter light is off, power has been interrupted, the transmitter is not properly seated in the adaptor, or there is no Transmitter on the adaptor. When the Field and Pro series charging adaptor is attached to the transmitter body, there will be a positive “snap” feel when the Transmitter locks into the adapter correctly.

Note that the Sport G3 model transmitters are not rechargeable. Those units use replaceable 9v batteries. One 9-volt battery is already installed. See “Replacing Your Batteries” on page 37 of this manual for instructions about when the battery needs replacement and how to replace it.

- (A) Adaptor Charging Contacts**
- (B) Jack for AC Power Supply** (located on the back)
Use only the correct Tri-Tronics wall cube
(supplied with this unit) for this charging adaptor.

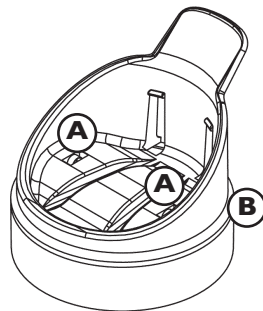

PLEASE NOTE THAT THE CHARGING CRADLES AND ADAPTORS ARE NOT DESIGNED TO GET WET

FITTING THE COLLAR ON THE DOG

Insert the collar strap through all three belt loops on the receiver and snug the strap against case. Place the collar strap in the middle of the dog's neck. The receiver should be on the underside of the neck although on some dogs the receiver will naturally seek a slightly off-center position. The receiver light should face forward (towards the dog's nose). The charging contacts should face backwards (towards the dog's chest).

Tighten the buckle by holding it with two fingers as you pull the strap snug. Remote training collars must be put on a dog quite snugly to ensure consistent contact and reliable stimulation. Do not put any fingers under the strap as you tighten it. Slip the free end of the strap through any D-ring or keeper that is present, and through both sides of a double-sided buckle. You can easily adjust the strap for different sized necks by moving the receiver to a new position on the strap. If the strap is too long for your dog, cut off the excess length. Leave enough length to go through the D-ring or keeper with at least 3 inches to spare.

NOTE: Do not cut the collar strap of your Upland unit until you have also installed the Beeper on the strap or your cut strap may be too short to reach around both the receiver and the Beeper.

Please note that Remote Trainers are not designed to be worn continuously by a dog. To prevent irritation caused by rubbing, remove the collar for at least eight hours out of every 24-hour period. See the additional information in the Product Safety section of this guide.

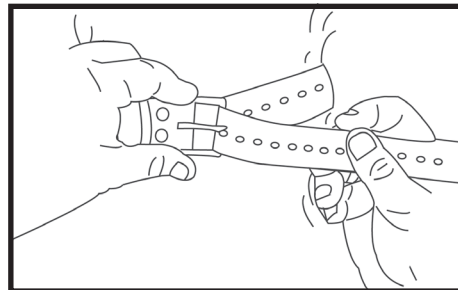

STIMULATION OVERVIEW

Your Remote Trainer has many levels of intensity so you can find the best level to fit the temperament of your dog and the type of training you do. You may also select either continuous or momentary stimulation, again depending upon dog temperament and your training purpose.

Intensity Selection

There are two ways to change intensity, with the intensity dial or with the button you choose. When you want a different intensity level, you can move the intensity dial or use a different transmitter button, or do both, depending on your model. This flexible approach to remote training has made Tri-Tronics products the favorite of both experienced trainers and beginners for many years.

The numbers on the intensity dial indicate the stimulation intensity level. These numbers are 1 – 6 on your Field or Pro G3 Series model. They are 1 – 5 with half steps, for a total of 10 distinct dial levels, on your Sport G3 Series model. You can use a stronger or milder version of each numbered dial level on the Sport Combo G3 (depending upon mode selected), and on all Field & Pro G3 Series models other than the Classic 70, Trashbreaker, and Field 90. Some models allow multi-button control only for continuous stimulation, some allow it only for momentary stimulation, and some allow it for both types of stimulation.

Note: See the Model Guide Section beginning on page 5 for the exact button functions of your model. Multi-Dog Intensity Tip. When training more than one dog, check the intensity dial to be sure you have the intensity set at the level you want for the dog you are about to correct.

Other Intensity Dial Functions

Letters (“N,” “T,” or “A” depending on model) indicate no-stimulation functions. No stimulation can be produced by the receiver when the intensity dial is set on one of these letters. Set the dial on a number when stimulation is desired.

“N” (neutral) – Transmitter buttons do not function. No tone, buzz, beeper, or stimulation functions are possible.

This setting is intended for times when your transmitter buttons might be accidentally bumped or pressed.

“T” – The stimulation buttons produce tone from the receiver instead of stimulation.

“A” – Any transmitter button will operate the Beeper or the Tracer™.

CONTINUOUS AND MOMENTARY STIMULATION

Continuous Stimulation

The dog trainer controls the timing of “continuous” stimulation. Continuous stays on while the transmitter button is pressed and held down, up to an automatic “time-out” of about 8 seconds. If the stimulation times out, restore function by releasing the button and pressing again. In normal use stimulation does not time out because corrections are far shorter than 8 seconds. You can also tap the continuous button repeatedly for a series of corrections.

Momentary Stimulation

The duration of “momentary” stimulation is pre-set. Momentary stays on only briefly no matter how long the transmitter button is pressed. To produce a series of momentary corrections, press the momentary button repeatedly.

RANGE

The Trashbreaker G3 has a range of up to two miles. All other Field & Pro G3 Series models have a range of up to one mile. All Sport G3 models have a range of up to half a mile.

Your actual range depends on terrain, weather, vegetation, other radio transmissions in the area, and other factors. To improve range, the antenna should not touch your body or anything else while you are transmitting. For the very best range, hold the transmitter overhead while transmitting.

TRI-TRONICS BEEPER

The Tri-Tronics Beeper lets you know where your bird dog is hunting and when he goes on point. The Beeper has a wide choice of settings to suit different hunting styles and individual preferences. You can also keep track of several dogs at one time by varying the settings you select.

Your Beeper can be switched on and off from a distance using the transmitter of any Field Series or Pro Series model and the Sport Upland G3. Therefore, you can leave the Beeper off most of the time, and only switch it on when required by hunting conditions.

If you purchased a Sport Upland G3 or Upland Special G3 your transmitter has one button specifically for switching the Beeper on and off. If you purchased any other Field or Pro G3 series model you can use any transmitter button to switch the Beeper on or when your transmitter dial is set on "A." If you purchased a Sport Basic G3 or Sport Combo G3, you cannot switch your Beeper on or off from a distance, but your Beeper will have all other functions, such as choice of mode, run and point tones, and volume control, as described in this owner's guide.

Battery

One 9-volt battery is already installed in your beeper. See "Replacing Your Batteries" on page 37 of this manual for instructions about when the battery needs replacement and how to replace it.

Beeper Placement

Adjust the position of your Beeper on your collar strap for the size of your dog, taking into account where you want the buckle to be for proper tightening on the dog. The Beeper should ride directly across from the receiver when placed on your dog, with the Beeper on the top of the dog's neck and the receiver underneath his neck.

The collar strap may be cut off to fit your dog's neck. Never cut the strap until both the Beeper and Remote Trainer are installed on the strap or your strap will be too short.



Place the Beeper so that the power switch will face towards the dog's tail when training. This placement prevents the power switch from being brushed against cover as your dog hunts and switching the Beeper off.

Beeper Power Switch

The Beeper power must be switched on at the Beeper in order for the Beeper to operate. Press the round power switch located on the rear surface of the Beeper. You will hear two tones and the Beeper light will begin flashing. The Beeper will begin beeping as soon as its power is switched on. If you want to silence it until you begin hunting, use the remote switch-on/off feature (see next section). To save Beeper battery life, switch the Beeper power switch off after use.

Remote Switch-On/Off

(Does not apply to Sport Basic G3 or Sport Combo G3.) In order to control your Beeper remotely with your transmitter you must first switch both the Beeper and the receiver on. Pressing the Beeper control button Switches the Beeper on or off from a distance, up to the full range of your Remote Trainer. Tones confirm "on" and different tones confirm "off." The Beeper control button is the top button on the Sport Upland G3 and is located above the stimulation controls on the Upland Special G3 EXP. It is any button on the other Field & Pro G3 Series models when the intensity dial is set on the "A."

Locate Feature

(Does not apply to Sport Basic G3 or Sport Combo G3.) To locate your dog when the Beeper is silent, press and hold the Beeper button. You will hear several tones, letting you know where your dog is. (Note: To operate the remote switch-on/off and locate features, your Remote Trainer must be activated and the transmitter dial not set on “N.” Dial must be on “A” for the non-Upland models.)

BEEPER SETTINGS

Volume Control

Two settings – Low or High

Modes

Range/Point or Point-only. In the range/point mode, the Beeper sounds once every 5 seconds while the dog is running, and sounds once every second when the dog goes on point. In point-only mode, the Beeper is silent until the dog goes on point, then sounds once every second.

Run Tones

Single Beep, Double Beep, Triple Beep, or Tracking Tone. You may select one of four tones as your run tone. When the Beeper is set on range/point mode, you will hear the run tone every 5 seconds while the dog is hunting. Your hearing and your personal preference will determine which run tone you prefer. You can distinguish among several dogs hunting at the same time by setting each dog’s Beeper on a different run tone. The tracking tone reflects some of the actual hunting motion of your bird dog, much like the jingle of the traditional bell. It enables you to keep track of how your dog is hunting better than the beeping of the other run tones. Note that using the tracking tone will shorten battery life and you will need to change the 9-volt battery in the Beeper more frequently.

Point Tones

Single Beep or Hawk Scream. You may select one of these two tones as your point tone. You will hear the point tone once every second while the dog is on point. Your hearing and your hunting preference will determine which point tone you prefer.

Changing Beeper Settings

Remove Battery Compartment Cover. Hold the Beeper upside down and unscrew the four Phillips head screws on the bottom of the Beeper. Slide the battery compartment cover along the collar strap to expose the battery compartment and the Beeper switches.

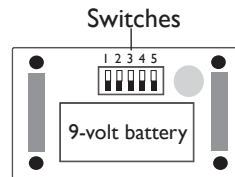

When setting switches, hold the Beeper as shown

Volume Switch

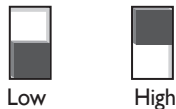

Modes:

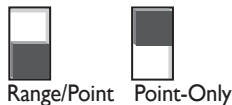

Run Tones:

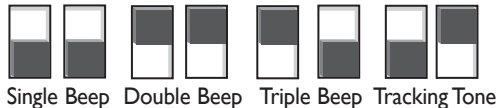

Point Tones:



Switch Settings

Hold the Beeper so that the switches are on the top edge of the compartment, as shown in the diagram. You do not need to switch the Beeper off to change the settings or to make the new settings take effect.

To select your settings, set the switches in the positions shown in the diagram. The switch setting is indicated by the dark rectangle in the diagram section. All switches except the volume switch make a confirming “chirp” when their positions are changed. Replace the battery compartment cover when done.

Dark indicates switch position

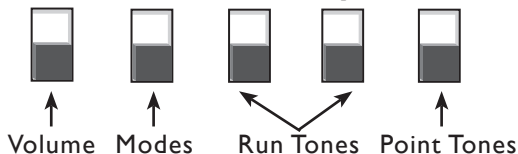

Introducing an Inexperienced Dog to the Beeper

The Beeper is loud. It can startle or alarm an inexperienced dog at first. If your dog isn't used to beeper collars, begin hunting with the Beeper set on low volume instead of high volume. You can also muffle the sound by placing duct tape over the horn, or a cotton ball in the horn. Another technique for getting a dog used to beeper collars is to hang a beeper at least 20 yards away from the dog's kennel, and let the dog listen to it beeping for several hours before you put it on to hunt.

Beeper Care and Maintenance

Remove the Beeper from the collar strap for thorough cleaning. You can wipe the Beeper with a damp cloth and mild detergent if desired.

- Do not use any solvents as they can cause damage.
- Do not submerge the Beeper when cleaning it.

Dirt and debris in the Beeper horn can cause the sound to change.

- To clean debris from the Beeper horn, use only a moistened cotton swab.
- Do not use any sharp or pointed objects or damage to the horn may result.

REPLACING BATTERIES

Sport G3 Transmitter and Beeper

Your product is shipped with one 9-volt battery installed. This battery will last for many months with normal use. If you see the Transmitter indicator light fail to light up at all or flash rapidly when a button is pressed it is time to replace the transmitter battery. To change the battery on your Sport G3 Transmitter, unscrew the four Phillips head screws on the back of the transmitter, and lift off the battery cover to expose the battery compartment.

To change the battery on your Beeper, unscrew the four Phillips head screws on the underside of the Beeper. Slide the battery cover along the collar strap to expose the battery compartment.

Remove the old battery and install the new battery in the correct direction. Use a Duracell or Eveready 9-volt alkaline battery. Note that some other brands will be too long and will not fit correctly. Never force a battery into this compartment. Replace the battery cover and tighten the screws (do not over-tighten).

Check for function by switching the Beeper on, or by pressing a button on the transmitter while you watch the transmitter indicator light. If there is no function, you may have installed the battery backwards. If so, take it out and switch it around.

Field and Pro Series G3 Transmitter

Your rechargeable Field Series or Pro Series G3 transmitter batteries will last for several years with proper care. When your transmitter batteries do need replacement you can replace them yourself with a convenient battery pack obtained from Tri-Tronics. Loosen the two screws and remove the battery compartment door.

Note: the screws are not meant to be removed from the battery compartment door. When removing the compartment door take care to not damage the gasket between the door and the transmitter body. Remove the battery pack. Insert the new battery pack, metal tabs facing in and blue foam facing out. Match + and - label on battery with + and - label on the unit. Replace battery door and tighten screws.

Receiver

Proper battery care will help ensure maximum life from your rechargeable receiver batteries. When your receiver batteries do need to be replaced, you can replace them yourself with a convenient battery pack obtained from Tri-Tronics. Follow the instructions included with the new battery pack.

CARE AND CLEANING OF TRANSMITTERS AND RECEIVERS

- Check contact points regularly for tightness, dirt or damage.
- If the receiver has been used in saltwater or brackish water clean it with clean drinking water.
- If the receiver charging contacts are dirty then clean them prior to charging.
- Wipe transmitter charging adaptor connections with a dry, clean cloth.
- For best battery life, do not store your remote trainer in very warm areas such as the dashboard of a closed vehicle.
- For best battery performance avoid transporting or storing your Remote Trainer in extremely cold areas.
- Please note that the charging cradles are not designed to get wet.

RADIO SIGNAL ISSUES

Modern microprocessor technology virtually eliminates the possibility that your unit could be unintentionally set off by someone else with a Tri-Tronics product. Please contact our Customer Service Department at support@tritronics.com or 1-800-456-4343 with any questions.

FCC COMPLIANCE

The manufacturing of Tri-Tronics remote trainers involves exacting production methods, precise tuning, and stringent quality control tests. In addition, these products are manufactured to operate within Federal Communication Commission (FCC) specifications. It is a violation of FCC rules to modify your equipment. Tri-Tronics verifies its products to operate under Part 95 of FCC regulations. Unauthorized modifications to your equipment could result in its not meeting specifications and thus violating FCC regulations. Any and all adjustments should be performed only by technically qualified personnel authorized by Tri-Tronics. To continue to meet FCC operating specifications, any replacement of circuit components including antennas must meet Tri-Tronics' manufacturing specifications. This device complies with Part 15 of the FCC rules. Operation is subject to the following two conditions: (1) This device may not cause harmful interference, and (2) this device must accept any interference received, including interference that may cause undesired operation.

TROUBLESHOOTING GUIDE

Note: Giving the Remote Trainer a good charge can often resolve a performance problem.

Also, it is fine to leave a unit on the charger between uses and this may be the best way to ensure that your Remote Trainer stays well charged.

Note About Cold Weather Performance

All batteries experience a normal drop in voltage during cold weather. As a battery powered device, your Remote Trainer can be affected by normal voltage drops during winter months and experience such things as:

- Batteries can run down more rapidly.
- Unit can be “dead” before you expected based on last charging.
- Stimulation can become weaker.
- Unit can switch itself off while training (evidence of low batteries).

For best performance during winter months, follow these guidelines:

1. Keep the unit at room temperature when it is not being used. Do not store overnight in unheated areas such as vehicles, sheds, or garages. When traveling, transport your Remote Trainer in the passenger cab, not in the back of the truck.
2. Charge the unit at room temperature. If the unit is cold, give it two hours to reach room temperature before charging.
3. Charge more frequently and allow a full 2-hour charge whenever possible.
Note: The Remote Trainer may be left on charge when not in use (trickle charge).
4. Check the tri-color battery life indicator for a color change, and always check just prior to training.
5. Also note that in very cold weather, you may need to use a slightly higher stimulation setting to achieve the same level of intensity.

SYSTEM PROBLEMS

Problem #1: No stimulation when a transmitter button is pressed.

The receiver has not been activated. The receiver must be switched on or it won't work at all.

The receiver has not been set to your transmitter. Follow the instructions on page 24.

The transmitter intensity dial is set on "N," "T," or "A." Select a numbered position.

The batteries in either the receiver or the transmitter are dead. Recharge or replace, as needed.

The batteries are not taking a charge. Either you need new batteries or the charging system is not working. See whether the charging adaptor or cradles light is glowing red while connected to the charger. The power may not be working. Try another wall outlet. If using a power strip, make sure it is switched on and working.

You are using the wrong transmitter. If you own more than one Tri-Tronics transmitter or train with someone who has a Tri-Tronics product, check that you have not accidentally switched transmitters.

Problem #2: The Remote Trainer doesn't have range, or the range has been significantly reduced.

Either you or the dog is shielded by a metal structure. Metal fences, chain link dog enclosures, screen doors, buildings, and other metal structures can affect the radio signal. Operate the Remote Trainer away from these structures.

The receiver is on backwards. For best range, position the receiver so that the light faces toward the dog's nose.

You're experiencing temporary radio interference. Radio signals from nearby CBs and walkie talkies can reduce range. Wait a short while then try again, or move to another area.

Problem #3: The stimulation seems too high, not high enough, or the dog does not seem to feel it at all.

The collar strap is not tight enough. The collar should be snug. Contact points must press against the dog's skin to provide efficient, consistent stimulation.

The intensity position is not correct. The ideal intensity level depends on the dog and the training situation. Try a different level. Also note that in very cold weather, you may need to use a slightly higher setting to achieve the same level of intensity.

The contact points are too short for the dog's coat type. Use the long contact points instead.

The transmitter intensity dial is set on "N," "T," or "A." Select a numbered position.

The batteries in either the receiver or the Transmitter are dead. Recharge or replace as needed.

Debris or contaminants are interfering with electrical stimulation. Clean the receiver and contact point area.

Problem #4: The or transmitter light changes color to indicate low charge very quickly.

The unit has been left switched on between training sessions. Make sure the receiver is switched off after use.

You are training in very cold weather. The low battery indicator color change can occur prematurely in very cold weather.

Try charging the transmitter and receiver again even if the light is green.

Problem #5: The receiver deactivates itself while training.

The batteries have run down. The receiver light may require up to 20 seconds to register "low batteries" after you switch the unit on.

Check the receiver after 20 seconds to see if the low battery indicator is on. You normally can complete a training session after the low battery indicator flashes, but not in very cold weather.

Make sure the batteries are well charged.

Problem #6: The indicator light does not come on when the receiver is placed on the cradle or the Transmitter is placed on the adaptor.

Faulty cradles. Email us at support@tritronics.com, call 1-800-456-4343, or visit our website at www.tritronics.com to order a replacement.

The battery being charged is very low. Continue charging.

No AC current or contact is interrupted. Check all the connections. Wipe connections for receiver, transmitter and cradle with a dry, clean cloth.

Problem #7: The charging cradle becomes warm during charging.

This is not a malfunction. Heat build-up is normal. Do not charge in extremely warm areas such as a closed vehicle in the sun and be sure the vents are not blocked.

Problem #8: The light blinks red slowly when the unit is placed in the cradle or adaptor.

The cradle has diagnosed a failure condition in the battery pack being charged. Please call our Customer Service Department.

BEEPER PROBLEMS**Beeper Problem #1.****The Beeper does not make any sound when the power switch is switched on.**

The battery in the Beeper has run down. Replace as needed. Note that leaving the Beeper switched off when not in use will extend its battery life. Also note that using the tracking tone will shorten battery life. Use only Duracell or Eveready 9-volt batteries. Other brands may not fit correctly.

Loose battery connection. Gently pull the metal tabs in the Beeper battery compartment to hold the 9-volt battery more firmly.

Beeper Problem #2.**Pressing the Beeper control button on the transmitter does not switch the Beeper on or off.**

The Beeper power switch is off. Switch the Beeper power switch on.

The receiver has not been switched on. Switch the receiver on as described in this Owner's Guide.

The intensity dial is set on "N" or "T." Select a setting other than "N" or "T."

Transmitter is not set on "A" (non-Upland Special G3 and G3 EXP Field & Pro models only). Set the transmitter dial on "A" when you want to switch the Beeper on or off.

The Beeper is not directly across from the receiver. Slide the Beeper along the collar strap to achieve the orientation shown in the illustration in the Beeper "Quick Guide."

The 9-volt battery in the Beeper is dead. Replace as needed.

The batteries in the receiver or transmitter need charging. Recharge as recommended in this Owner's Guide.

Loose battery connection. Gently pull the metal tabs in the Beeper battery compartment to hold the 9-volt battery more firmly.

You are using the wrong transmitter. If you own more than one Tri-Tronics transmitter or train with someone who has a Tri-Tronics product, check that you have not accidentally switched transmitters.

You are using a Remote Trainer model that does not have the Beeper control feature. Check this Owner's Guide for your model to determine if it can operate a Tri-Tronics Beeper remotely, or call our Customer Service Department at 1-800-456-4343.

Beeper Problem #3.

The Beeper sound quality has become muffled or distorted.

Dirt or debris has become trapped in the horn. Remove trapped debris as described in the "Care and Maintenance" section.

Beeper Problem #4.

The Beeper light is on but the Beeper isn't working.

The Beeper battery is getting low. Replace the battery.

Beeper Problem #5.

The Beeper is changing modes on its own or is switching itself on and off without receiving a signal from the transmitter.

The Beeper battery is getting low. Replace the 9-volt battery.

Loose battery connection. Gently pull the metal tabs in the Beeper battery compartment to hold the 9-volt battery more firmly.

BASIC TRAINING INTRODUCTION and E-COLLAR BASICS

This training program, covering “Sit/Stay,” “Heel” and “Here” commands is also shown in the Basic Training DVD included with all Field Series and Sport Series products and features J. Paul Jackson of Lone Oak Retrievers.

When used properly, the e-collar is a very effective tool to aid your dog in reaching its full potential. However, the use of an e-collar is not a short cut. It should be used as part of an overall training program. Don’t make training sessions too complex initially by training several commands during the same training session. The dog will probably become confused and training could progress more slowly. Dog training is part art – know when to go faster, slower and when to take a break.

Contact Points and Collar Position

Before you begin using your e-collar you must first select the correct contact point length for your dog’s coat type. Use the longer contact points for dogs with thicker coats. Be sure that the collar strap is threaded through the belt loops and the receiver is switched on. Next place the receiver on the dog in a position such that the receiver is under the dog’s neck. The collar strap should then be pulled snug so the contact points of the receiver make good contact with the dog’s skin. The collar should ride snugly in place high on the dog’s neck. Check contact points regularly for tightness. Use only the Tri-Tronics plastic wrench to remove or tighten the contact points and do not over tighten.

Choosing the Correct Intensity Level

Selecting the intensity suitable for training your dog is next. You should begin using the lowest level of stimulation and observe the dog’s response. This should be done when the dog is not distracted and no command has been given. If there is no reaction, such as a head shake, neck movement or just a change in expression, increase intensity by one level. Keep increasing the level of stimulation until there is a slight but discernible physical reaction from the dog. The intensity level that causes this reaction is your base line level for beginning collar training. You do not need to, and should not, apply this intensity selection test again. Once you begin training the dog’s performance guides your intensity selection. As the dog advances in training you may need to change the level depending upon circumstances. Please keep in mind that sometimes dogs will vocalize due to the surprise of the electrical stimulation. But if the dog vocalizes more than once, the intensity level is too high for beginning training. Switch it down.

BASIC COMMANDS

Training should begin by teaching the dog a few basic commands (sit/stay, heel, here) using a leash and no stimulation. Once the dog responds consistently to the command on lead you can then start to condition the dog to the e-collar.

Heel

The first command that you will teach the dog is the “Heel” command. The training should begin on leash and in an area with minimal distractions. With the dog at your side command “Heel” and begin walking forward while at the same time pulling gently on the leash. If the dog gets in front of you, before the leash becomes tight, make a switch away from the dog and repeat the command “Heel.” Should the dog start to lag behind you, give light tugs on the leash to bring him back to your side. With plenty of repetition, consistency, patience, and a lot of praise, the dog should begin to walk beside you with some amount of stability in just a few short training sessions.

Sit/Stay

After the dog has begun to grasp the concept of walking at heel on lead it is time to introduce the Sit/Stay command. The actual command is “Sit,” and the “Stay” is implied. In other words, when you tell the dog to sit he should stay until you indicate otherwise.

You should begin training this command with the dog walking on lead in the heel position. Then simply stop, pull up on the leash and tell the dog to “sit” while maintaining steady pressure on the lead until the dog complies. Initially, the dog will almost certainly be confused, and you may need to gently push down on the dog’s back just above his flank to make him sit. Be sure to reward compliance with plenty of praise. As with all training, repetition, consistency and patience are the keys to achieving success.

Here

The last basic obedience command is “Here”. With the dog in a sitting position simply move away to the end of the leash and command the dog to come “Here” while giving a gentle tug to the leash. Do not be surprised if you meet some resistance at first. After all, up until this point you have been teaching the dog to sit and stay in one place.

USING THE COLLAR AS A TRAINING TOOL

Collar Introduction

Once the dog demonstrates that he has a grasp of the concepts of these three basic commands the e-collar can be introduced.

During the initial stage of collar introduction the dog learns that collar stimulation means the same thing as a leash tug. All work during this step of the training process should be done on lead to maintain control and a safe working environment. Begin by walking the dog on leash with the e-collar on and in place. With the leash held short, command “Sit” while pulling up on the leash just as you did earlier. At the same time press a stimulation button briefly at the level you have selected for this dog. At first the dog may be alarmed by the electronic stimulation. Once again, the key here is to be patient and consistent and to not start off at too high of an intensity.

With repetition and a lot of praise, the dog will soon begin to demonstrate consistent, stable response to the command “Sit.” Also, as you repeat this training the dog should begin to respond more quickly. As the dog becomes more responsive, you should begin to stimulate intermittently – at times giving the dog a “freebie.” This will help keep the dog’s attitude upbeat, and let you know that the dog is responding to the command rather than just the collar.

Remember that if the dog doesn’t respond to the stimulation level you have selected, switch it up one level at a time until you achieve the appropriate response. Once the desired response is achieved, the stimulation level can be lowered as long as the dog maintains consistency.

Heel with the E-collar

You should continue the collar introduction process by moving from stimulating to “Sit” to stimulating to “Heel.” This progression should be made after the dog begins to demonstrate that it has properly associated the collar stimulation with the command to “Sit.” Many dogs will indicate that it is time to make this transition by trying to sit before being commanded to do so in an effort to avoid the stimulation associated with the command.

Once again, you will begin by walking the dog on lead at heel. Should the dog try to sit or lag behind you should stimulate the dog while tugging on the lead and commanding “Heel.” If the dog tries to move ahead of you tap a stimulation button briefly,

repeat the command, and move in another direction or pull back on the lead. As the dog begins to show a consistent response to the command “Heel,” the e-collar can be used less often.

Be sure to give your dog a “freebie” now and then once he becomes more responsive, and always praise a job well done.

Teaching the “Here” Command with the Collar

This is perhaps the most important command that your dog will ever learn. The here command helps you maintain control of the dog, and it allows you to pull him away from potentially dangerous situations. Due to its importance it is imperative that this command be taught correctly. Therefore, you should only begin to teach the dog the here command with the collar after the dog has been taught the sit/stay command and demonstrates that he understands the collar for the “Sit” and “Heel” commands.

As with the other phases of collar introduction you will begin stimulating the dog to “Here” on lead. You may even want to use a “long line” or 20 foot leash. Begin by putting the dog on a sit/stay position and then moving away from him. Turn around to face the dog and command “Here.” At the same time tug on the line and press a stimulation button briefly to help the dog move toward you. Be sure to reward the dog with lots of praise whenever he comes after being called. As with the other commands, you can start to introduce distractions as the dog’s proficiency increases.

Cautionary note: Teaching this command may be a little confusing to the dog at first. After all, in earlier training he got corrected if he moved from the “Sit” position on his own. Now if he remains sitting when called he is getting corrected to make him come to you. Therefore, consistency and patience are perhaps more important here than ever, together with plenty of praise whenever he does it right.

Training with the Collar Only

After the dog begins to respond consistently to the command during collar conditioning, typically after about 5 or 6 training sessions using the e-collar, you can remove the leash and train with just the e-collar. As the dog becomes more proficient with these commands, you can begin to introduce distractions, such as rolling a ball in front of the dog or walking him in the presence of others. Eventually in most training circumstances all your commands will be “freebies” (no stimulation given with the command). You will use stimulation anytime you need to repeat a command because the dog did not obey the first one.

As the dog becomes better trained, the use of an e-collar will gradually decrease. However, you should continue to have the dog wear the collar until you feel certain that it is no longer needed to reinforce known commands. Abandoning the collar too early can lead to problems in the future. Remembering to be fair and consistent in using the collar as a training tool will help you avoid most problems, and it will allow you to help your dog reach his full potential.

