

# burks®

## INSTALLATION AND OPERATION MANUAL

### Turbine Pumps

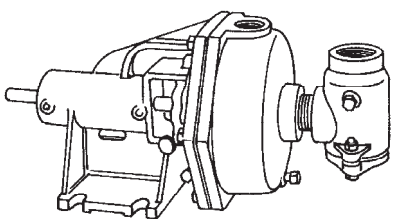

SERIES: EC & ED

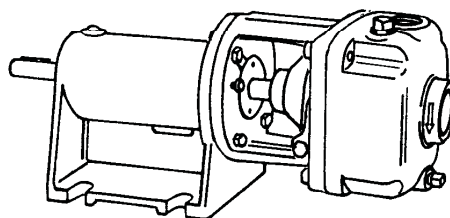

SERIES: ES

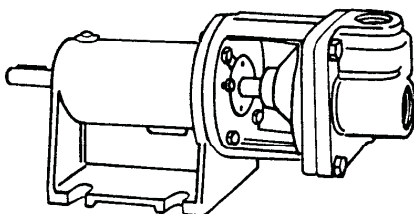

SERIES: ET

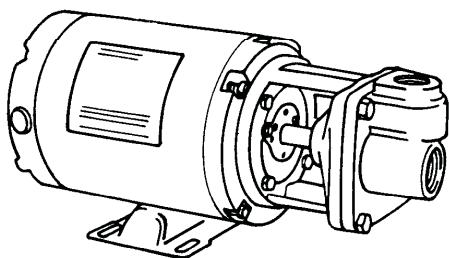

SERIES: CT

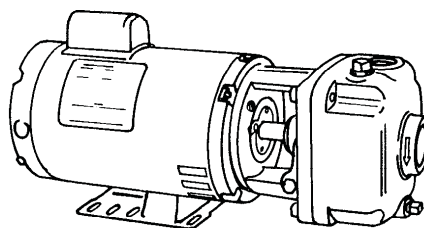

SERIES: CS

**IMPORTANT!**

*Read all instructions in this manual before operating pump.*

*DO NOT work on pump until you are sure pump and associated piping are totally depressurized, pump and motor have cooled down. As a result of Crane Pumps & Systems, Inc., constant product improvement program, product changes may occur. As such Crane Pumps & Systems reserves the right to change product without prior written notification.*

**CRANE**

A Crane Co. Company

**PUMPS & SYSTEMS**

420 Third Street  
Piqua, Ohio 45356  
Phone: (937) 778-8947  
Fax: (937) 773-7157  
www.cranepumps.com

83 West Drive, Bramton  
Ontario, Canada L6T 2J6  
Phone: (905) 457-6223  
Fax: (905) 457-2650

Form No. F0807D-Rev. E

# SAFETY FIRST!

Please Read This Before Installing Or Operating Pump. This information is provided for **SAFETY** and to **PREVENT EQUIPMENT PROBLEMS**. To help recognize this information, observe the following symbols:



**IMPORTANT!** Warns about hazards that can result in personal injury or indicates factors concerned with assembly, installation, operation, or maintenance which could result in damage to the machine or equipment if ignored.

**CAUTION!** Warns about hazards that **can or will cause minor** personal injury or property damage if ignored. Used with symbols below.

**WARNING!** Warns about hazards that can or will cause serious personal injury, death, or major property damage if ignored. Used with symbols below.



Hazardous fluids can cause fire or explosions, burns or death could result.



Extremely hot - Severe burns can occur on contact.



Biohazard can cause serious personal injury.



Hazardous fluids can Hazardous pressure, eruptions or explosions could cause personal injury or property damage.



Rotating machinery Amputation or severe laceration can result.



Hazardous voltage can shock, burn or cause death.

Only qualified personnel should install, operate and repair pump. Any wiring of pumps should be performed by a qualified electrician.

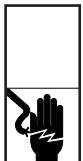

**WARNING!** To reduce risk of electrical shock, pumps and control panels must be properly grounded in accordance with the National Electric Code (NEC) or the Canadian Electrical Code (CEC) and all applicable state, province, local codes and ordinances. Improper grounding voids warranty.



**WARNING!** To reduce risk of electrical shock, always disconnect the pump from the power source before handling or servicing. Lock out power and tag.



**WARNING!** Operation against a closed discharge valve will cause premature bearing and seal failure on any pump, and on end suction and self priming pump the heat build may cause the generation of steam with resulting dangerous pressures. It is recommended that a high case temperature switch or pressure relief valve be installed on the pump body.



**CAUTION!** Pumps build up heat and pressure during operation-allow time for pumps to cool before handling or servicing.



**WARNING!** This pump is designed to handle materials which could cause illness or disease through direct exposure. Wear adequate protective clothing when working on the pump or piping.



**WARNING!** Do not pump hazardous materials (flammable, caustic, etc.) unless the pump is specifically designed and designated to handle them.



**WARNING!** Do not wear loose clothing that may become entangled in moving parts.



**WARNING!** Keep clear of suction and discharge openings. **DO NOT** insert fingers in pump with power connected.



Make sure lifting handles are securely fastened each time before lifting. **DO NOT** operate pump without safety devices in place. Always replace safety devices that have been removed during service or repair. Secure the pump in its operating position so it can not tip over, fall or slide.

**DO NOT** exceed manufacturers recommendation for maximum performance, as this could cause the motor to overheat.



**WARNING!** To reduce risk of electrical shock, all wiring and junction connections should be made per the NEC or CEC and applicable state or province and local codes. Requirements may vary depending on usage and location.



**WARNING!** Products returned must be cleaned, sanitized, or decontaminated as necessary prior to shipment, to insure that employees will not be exposed to health hazards in handling said material. All Applicable Laws And Regulations Shall Apply.

Bronze/brass and bronze/brass fitted pumps may contain lead levels higher than considered safe for potable water systems. Lead is known to cause cancer and birth defects or other reproductive harm. Various government agencies have determined that leaded copper alloys should not be used in potable water applications. For non-leaded copper alloy materials of construction, please contact factory.



Crane Pumps & Systems, Inc. is not responsible for losses, injury, or death resulting from a failure to observe these safety precautions, misuse or abuse of pumps or equipment.

These instructions are intended as a guide to good installation practice. A correct installation, combined with regularly scheduled maintenance will generally insure a longer and more trouble-free pump service life.

The tables below are for your convenience in maintaining these records.

**PUMP INSTALLATION AND PERFORMANCE RECORD**

Pump Catalog No. \_\_\_\_\_ Discharge Gauge, Reading \_\_\_\_\_ Head Feet  
 Pump Serial No. \_\_\_\_\_ Discharge Piping: Length \_\_\_\_\_ Feet  
 Date Installed \_\_\_\_\_ Diameter \_\_\_\_\_ Inches  
 Capacity \_\_\_\_\_ GPM \_\_\_\_\_ Liquid: \_\_\_\_\_  
 Total Head \_\_\_\_\_ Feet \_\_\_\_\_ Temperature \_\_\_\_\_ °F. \_\_\_\_\_  
 Suction (±) \_\_\_\_\_ Head Feet Specific Gravity \_\_\_\_\_  
 Suction Piping: Length \_\_\_\_\_ Feet Viscosity \_\_\_\_\_ @ \_\_\_\_\_ °F. \_\_\_\_\_  
 Diameter \_\_\_\_\_ Inches Amperage: Line-1 \_\_\_\_\_ Line-2 \_\_\_\_\_ Line-3 \_\_\_\_\_  
 Voltage-Pump Operating: \_\_\_\_\_

INSPECTION AND REPAIRS					
INSPECTED		OUT-OF SERVICE	BACK-IN SERVICE	REPAIRS	COST
DATE	BY				

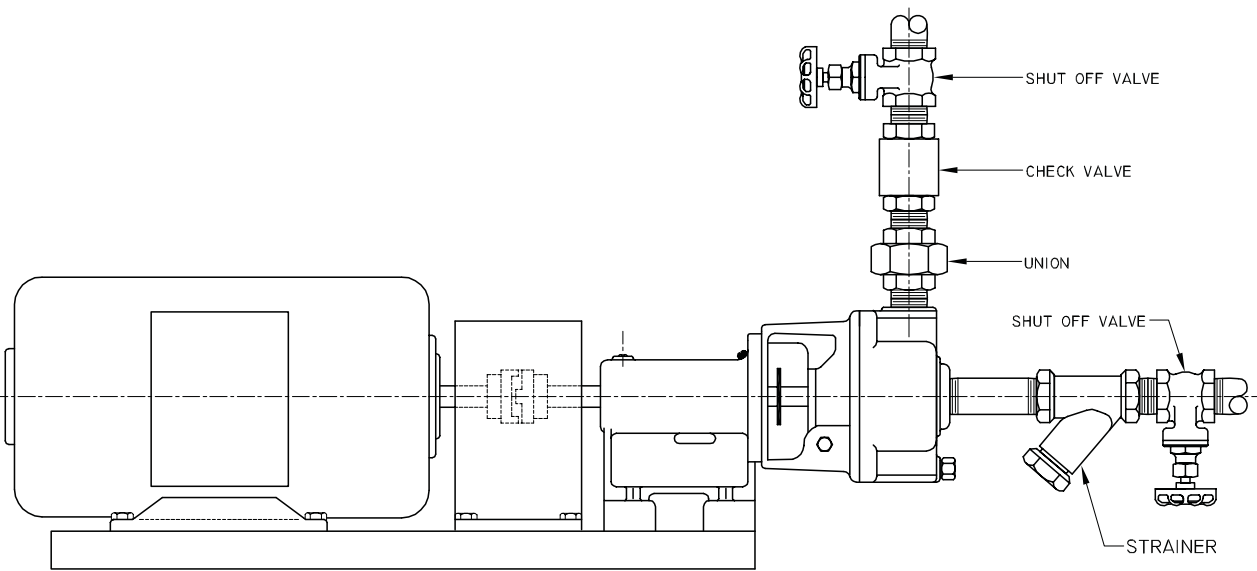

## GENERAL INFORMATION

### To the Purchaser:

Congratulations! You are the owner of one of the finest pumps on the market today. Burks® Pumps are products engineered and manufactured of high quality components. Over eighty years of pump building experience along with a continuing quality assurance program combine to produce a pump which will stand up to the toughest pumping projects.

This manual will provide helpful information concerning installation, maintenance, and proper service guidelines.

### Receiving:

Upon receiving the pump, it should be inspected for damage or shortages. If damage has occurred, file a claim immediately with the company that delivered the pump. If the manual is removed from the crating, do not lose or misplace.

Unless otherwise specifically agreed, all capacity, head and efficiency guarantees are based on shop test when handling clear, cold, fresh water at a temperature not over 85°F.

### Storage:

**Short Term** - Burks Pumps are manufactured for efficient performance following long inoperative periods in storage. For best results, pumps can be retained in storage, as factory assembled, in a dry atmosphere with constant temperatures for up to six (6) months.

**Long Term** - Any length of time exceeding six (6) months, but not more than twenty four (24) months. The units should be stored in a temperature controlled area, a roofed over walled enclosure that provides protection from the elements (rain, snow, wind blown dust, etc.), and whose temperature can be maintained between +40 deg. F and +120 deg. F.

If extended high humidity is expected to be a problem, all exposed parts should be inspected before storage and all surfaces that have the paint scratched, damaged, or worn should be recoated with a water base, air dry enamel paint. All surfaces should then be sprayed with a rust-inhibiting oil.

### Service Centers:

For the location of the nearest Burks Service Center, check your Burks representative or Crane Pumps & Systems, Inc., in Piqua, Ohio, telephone (937) 778-8947.

## LOCATION OF PUMP

The unit should be mounted in a dry location where it is easily accessible for inspection and maintenance. Allow ample clearance around the unit for free air circulation. If a dry location is not available, mount it on a foundation well above the wet floor. In order to keep the suction line as short as possible, place the pump close to the source of supply. Normally after being primed the pump can lift liquid from a supply 25 feet below the center line of the suction. However, where liquids at or near their boiling points are being handled, the supply must be located above the suction, so that the available NPSH will be greater than that required by the unit.

## ALIGNMENT

If the pump is driven by a flexible coupling, the angular, vertical and horizontal alignment must be checked. A straightedge across the coupling must rest evenly on both rims of the coupling at the top, bottom and sides. Alignment should be rechecked shortly after the initial start-up. Factory assembled units must be realigned at the job site due to the possibility of distortion in shipment. Final coupling alignment should be made with the system at operating temperature.

## PIPING



**DO NOT Use The Pump As A Piping Support.**

It is very important that the pipe be independently supported near the pump so that no strains will be transmitted to the unit. External loads caused by the pipe cause misalignment with subsequent failure of bearings and internal parts. Suction and discharge sizes are selected for proper performance of the pumping unit and are not intended to determine the suction and discharge pipe sizes. Pipe sizes must be determined by the user based on the system requirements.

## SUCTION PIPING

Suction piping should be short in length, as direct as possible, and never smaller in diameter than the pump suction opening. **The suction pipe should slope upward to the pump inlet.** A horizontal suction line must have a gradual rise to the pump. Any high point in the pipe will become filled with air and thus prevent proper operation of the pump. When reducing the piping to the suction opening diameter use an eccentric reducer with the eccentric side down to avoid air pockets. **Never use a straight taper reducer in a horizontal suction line, as it tends to form an air pocket in the top of the reducer and the pipe.**

**Valves in Suction Piping** - If the pump is operating under static suction lift conditions, a foot valve or check valve should be installed in the suction line to avoid the necessity of priming each time the pump is started. A strainer, approximately 20 mesh, should be installed on the suction side of the pump to prevent chips, scale or hard foreign particles from entering the pump and damaging the raceway and impeller.

**The pump must never be throttled by the use of a valve on the suction side of the pump.** Valves should be used only to isolate the pump for maintenance purposes, and should always be installed in positions to avoid air pockets.



**WARNING: BURKS Turbine Pumps are of the positive displacement type. When the pump is operating, liquid will be delivered to the discharge side of the pump. If the discharge line is blocked or closed, pressure will build up until the motor stalls, a pump part breaks or the piping bursts. To prevent the possibility of equipment damage or personal injury, a pressure relieving device of adequate size must be incorporated in the discharge side of the system.**

## DISCHARGE PIPING

On long horizontal runs it is desirable to maintain as even a grade as possible. Avoid high spots, such as loops, which will collect air and throttle the system or lead to erratic pumping.

**Valves in Discharge Piping** - A check valve gate valve should be installed in the discharge. The check valve, placed between the pump and the gate valve, protects the pump from excessive pressure, and prevents liquid from running back through the pump in case of power failure. The gate valve is used when shutting the pump down.

## GAUGES

**Pressure Gauges** - Properly sized pressure gauges should be installed in both the suction and discharge side of the pump. The gauges will enable the operator to easily observe the operation of the pump, and also determine if the pump is operating in conformance with the performance curve. If cavitation, vapor binding or other unstable operation should occur, widely fluctuating discharge pressure will be noted.

## JACKETED SEAL CAVITY PIPING

The cooling fluid must enter the lower pipe connection to the cooling cavity and leave the upper pipe connection to insure that the cooling cavity is always full of fluid. Cooling fluid must be turned on when pump is running. The cooling fluid cavity must not be under pressure. The fluid leaving the cavity should flow to a drain. Cooling fluid should run for a brief period after shutdown to prevent "Heat Soaking".

## OPERATING



**WARNING:** Failure to connect the motor frame to the power supply equipment grounding conductor by using the grounding cord, green screw or green wire provided may result in serious electrical shock.

## PRIMING

Before starting the pump it is necessary that both the casing and suction pipe be completely filled with liquid. This priming can be accomplished by any of the following methods.

- A. When the liquid supply level is above the center line of the pump, it is primed by opening the suction and discharge valves. The inflowing liquid will displace the air and fill the suction line, pump casing, and discharge line up to the level of supply.
- B. Where the pump is operating with suction lift and the suction line is equipped with a foot valve, the system is filled with liquid by filling through the discharge piping or priming plug if provided.

## PRIOR TO STARTING

Before the pump is started initially, make the following inspections:

- Check Rotation - Be sure that the pump operates in the direction indicated by the arrow on the pump casing or frame, as serious damage can result if the pump is operated with incorrect rotation. Make sure the shaft rotation is clockwise when looking at the motor end of the pump.
- Check all connections to motor and starting device with wiring diagram. Check voltage, phase and frequency on motor nameplate with line circuit.



**IMPORTANT ! - All pumps with 3 phase motors MUST be installed with a magnetic starter which provides 3 leg protection for motor. Failure to use correct starter will void warranty.**

## STARTING

Follow the steps below in the order indicated to start pump:

- Open gate valve in discharge line wide open.
- Open gate valve in suction line wide open.
- Turn on power to pump motor.

If the pump does not prime properly, loses its prime during start-up it should be shut-down and the condition corrected before the procedure is repeated.

If the motor runs, but no water is pumped, be sure pump is primed, that there are no air leaks in suction piping, that all gate valves are open and all check valves operate.



**IMPORTANT ! - DO NOT operate pump at pressures above those shown for a given horsepower in the performance and selection tables, operating above maximum recommended pressure will overload the motor and void the warranty.**

## OPERATING CHECKS

After initial start-up:

- Check the pump and piping to assure there are no leaks.
- Check and record pressure gauge readings for future reference.
- Check and record voltage, amperage per phase.

## MAINTENANCE

### LUBRICATION

No lubrication is required for the liquid end of any BURKS Turbine pump. Motors are equipped with ball bearings which are grease-packed and sealed at the factory. No additional lubrication is required. Base-mounted pumps have ball bearings in the Power Frame Assembly which are grease-packed at the factory and have provisions for re-lubrication as required. Use Chevron SR1 grease, or equal. For continuous operation, lubricate annually. For intermittent operation, lubricate every two years. **DO NOT over-lubricate.**

### **SHAFT SEAL**

The mechanical shaft seal should be replaced if water is noticed around the motor shaft. Remove case and impeller and, using two screw drivers to pry on each side, remove seal stationary seat. Clean seat area of frame, install new stationary seat with ceramic surface facing out toward impeller and slide new rotating element over shaft sleeve with hard carbon surface against ceramic seat. Be sure to keep all surfaces clean. Lubricating seal parts with water will help the installation of the seal. Reinstall impeller and pump case.

### **STUFFING BOX**

Pumps equipped with a stuffing box depend upon a small amount of water leakage for packing lubrication. Drain sump below the stuffing box is provided with a 1/4" pipe tapping for attaching a drain pipe if desired. Stuffing box should be tightened with pump running. A finger tight adjustment is generally sufficient. When installing additional packing, the joints of successive packing pieces should be staggered to give the best results.

### **CLEANING STRAINER**

The strainer should be cleaned and flushed twice a year, or more often if necessary. A clogged strainer will seriously impair pump operation.

### **ADDING BOILER COMPOUND**

**BOILER COMPOUND SHOULD NOT BE INTRODUCED INTO SYSTEM ON THE SUCTION SIDE OF PUMP.**  
Boiler compound often coagulates when it contacts hot water and becomes abrasive, and will damage the raceway and impeller of the pump.

### **DRAINING THE PUMP**

To drain pump, remove 1/4" pipe plugs from bottom of pump frame and pump case. After pump has drained, start pump to discharge liquid from the impeller. Always protect the pump, piping, tank, etc., from freezing - or drain the system when there is a chance of freeze-up.

### **IMPELLER ADJUSTMENT**

After years of service, it may be desirable to adjust the impeller to compensate for water wear. If this is necessary, because of reduced capacity or pressure, see instructions on next page.

### **MOTOR**

Keep motor clean and dry. It is drip-proof when installed horizontally and the windings are protected from excess humidity, but extreme conditions should be avoided when possible. If motor fails to run, be sure power is on, all switches or electrical controls are closed, fuses are in order and all electrical connections are tight. (Motor must be repaired by Authorized Repair Station under terms of guarantee.)

### **FAILURE TO PUMP**

If the motor runs, but no water is pumped, be sure pump is primed, that there are no air leaks in suction piping, that all gate valves are open and all check valves operate.

## IMPELLER ADJUSTMENT INSTRUCTIONS

### CAUTION !

**IMPROPER ADJUSTMENT OF A NEW BURKS TURBINE PUMP WILL INVALIDATE THE WARRANTY.**  
*We are placing a wax over the adjusting screws on all turbine models (excluding the CR models). The wax on the CR model is placed in the socket head of the allen screw. This change has been placed to ensure that the adjustments are to factory settings when we ship them out. If these pumps are returned for a warranty claim, Crane Pumps & Systems will be able to tell if the adjustment has been tampered with. If the unit has been tampered with, the pump may not be covered under Crane Pumps & Systems warranty policy.*

LIFE-LOK® External Impeller Adjustment is a patented feature found exclusively on BURKS Turbine Pumps. It allows for precise setting of pump performance during production testing.

Every BURKS Turbine Pump is factory tested for optimum performance, and the impeller position is locked in. Any further adjustment of a new pump is not required or recommended.

LIFE-LOK® may be used for field readjustment to match systems pressure requirements if necessary.

LIFE-LOK® also provides a means of restoring pump performance without disturbing piping, disassembling pump, or costly parts replacement.

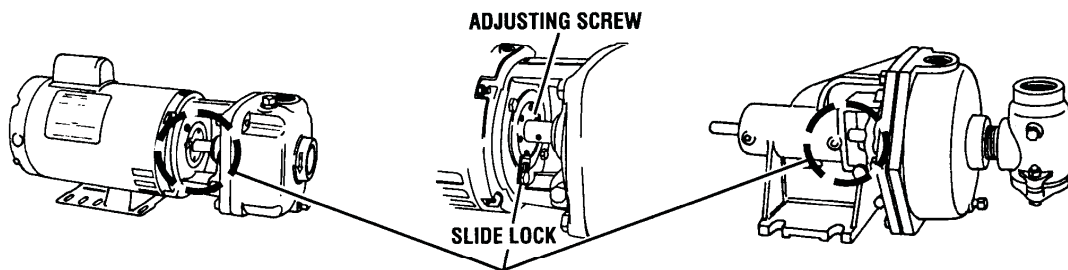

### TO ADJUST IMPELLER:

1. Disconnect electrical power. Adjustment should never be attempted while pump is running. Serious damage could occur.
2. Loosen slide lock and remove tab from hole in adjusting screw.
3. Turn the Adjusting Screw with a Spanner Wrench. (Do Not Use A Screwdriver, Punch or Other Tool.) At the same time, rotate the shaft back and forth with a common nail or other object placed through the hole provided for that purpose on close-coupled pumps. The shaft on base mounted pumps may be rotated by turning at the coupling end. (An Adjustable Spanner Wrench - Part No. 7492 - is available from BURKS.)
4. Rotate Adjusting Screw in a clockwise direction (Fig. 1). A drag will be felt as the impeller comes into contact with the raceway. At this point, make a mark on the pump frame and adjusting screw, across one of the spanner wrench holes (Fig. 2).
5. Rotate Adjusting Screw in the opposite direction (counter-clockwise) to back the impeller off and provide clearance between it and the raceway. The proper clearance may be obtained by moving the adjusting screw approximately one half the distance between two of the spanner wrench holes as indicated by the reference marks made in Step 4 (Fig. 3).
6. Lock the Adjusting Screw in place. Insert the tab of the Slide Lock in the nearest spanner wrench hole and tighten the lock screw.
7. Re-connect electrical power and start pump.  
If pump seems to labor unduly when coming up to pressure, a slight additional adjustment to increase the clearance between the impeller and raceway will be necessary. Do not allow pump to operate with insufficient clearance between those two parts. If adjustment does not restore desired performance, replacement of the impeller and raceway may be necessary. These are matching parts and must be replaced as a set. Repair kits are available for BURKS Turbine Pumps.

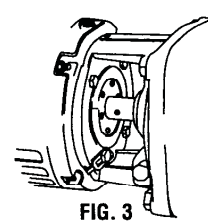
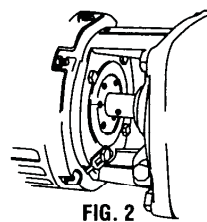
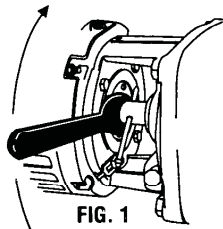

## RETURNED GOODS

RETURN OF MERCHANDISE REQUIRES A "RETURNED GOODS AUTHORIZATION".  
CONTACT YOUR LOCAL CRANE PUMPS & SYSTEMS, INC. DISTRIBUTOR.



Products Returned Must Be Cleaned, Sanitized, Or Decontaminated As Necessary Prior To Shipment, To Insure That Employees Will Not Be Exposed To Health Hazards In Handling Said Material. All Applicable Laws And Regulations Shall Apply.

# Limited 1 Year Warranty

We warrant that products of our manufacture will be free of defects in material and workmanship under normal use and service for twelve (12) months after notice of owner's acceptance, but no greater than twenty-four (24) months after receipt of shipment, when installed and maintained in accordance with our instructions.

This warranty gives you specific legal rights, and there may also be other rights which vary from state to state. In the event the product is covered by the Federal Consumer Product Warranties Law (1) the duration of any implied warranties associated with the product by virtue of said law is limited to the same duration as stated herein, (2) this warranty is a LIMITED WARRANTY, and (3) no claims of any nature whatsoever shall be made against us, until the ultimate consumer, his successor, or assigns, notifies us in writing of the defect, and delivers the product and/or defective part (s) freight prepaid to our factory or nearest authorized service station. Some states do not allow limitations on how long an implied warranty lasts, so the above limitation may not apply. **THE SOLE AND EXCLUSIVE REMEDY FOR BREACH OF ANY AND ALL WARRANTIES WITH RESPECT TO ANY PRODUCT SHALL BE TO REPLACE OR REPAIR AT OUR ELECTION, F.O.B. POINT OF MANUFACTURE OR AUTHORIZED REPAIR STATION, SUCH PRODUCTS AND/OR PARTS AS PROVEN DEFECTIVE. THERE SHALL BE NO FURTHER LIABILITY, WHETHER BASED ON WARRANTY, NEGLIGENCE OR OTHERWISE.** Unless expressly stated otherwise, guarantees in the nature of performance specifications furnished in addition to the foregoing material and workmanship warranties on a product manufactured by us, if any, are subject to laboratory tests corrected for field performance. Any additional guarantees, in the nature of performance specifications must be in writing and such writing must be signed by our authorized representative. Due to inaccuracies in field testing if a conflict arises between the results of field testing conducted by or for user, and laboratory tests corrected for field performance, the latter shall control. **RECOMMENDATIONS FOR SPECIAL APPLICATIONS OR THOSE RESULTING FROM SYSTEMS ANALYSES AND EVALUATIONS WE CONDUCT WILL BE BASED ON OUR BEST AVAILABLE EXPERIENCE AND PUBLISHED INDUSTRY INFORMATION. SUCH RECOMMENDATIONS DO NOT CONSTITUTE A WARRANTY OF SATISFACTORY PERFORMANCE AND NO SUCH WARRANTY IS GIVEN.**

This warranty shall not apply when damage is caused by (a) improper installation, (b) improper voltage (c) lightning (d) excessive sand or other abrasive material (e) scale or corrosion build-up due to excessive chemical content. Any modification of the original equipment will also void the warranty. We will not be responsible for loss, damage or labor cost due to interruption of service caused by defective parts. Neither will we accept charges incurred by others without our prior written approval.

This warranty is void if our inspection reveals the product was used in a manner inconsistent with normal industry practice and/or our specific recommendations. The purchaser is responsible for communication of all necessary information regarding the application and use of the product. **UNDER NO CIRCUMSTANCES WILL WE BE RESPONSIBLE FOR ANY OTHER DIRECT OR CONSEQUENTIAL DAMAGES, INCLUDING BUT NOT LIMITED TO LOST PROFITS, LOST INCOME, LABOR CHARGES, DELAYS IN PRODUCTION, IDLE PRODUCTION, WHICH DAMAGES ARE CAUSED BY ANY DEFECTS IN MATERIAL AND/OR WORKMANSHIP AND/OR DAMAGE OR DELAYS IN SHIPMENT. THIS WARRANTY IS EXPRESSLY IN LIEU OF ANY OTHER EXPRESS OR IMPLIED WARRANTY, INCLUDING ANY WARRANTY OF MERCHANTABILITY OR FITNESS FOR A PARTICULAR PURPOSE.**

No rights extended under this warranty shall be assigned to any other person, whether by operation of law or otherwise, without our prior written approval.







**IMPORTANT!**  
**WARRANTY REGISTRATION**

Your product is covered by the enclosed Warranty.  
Complete the Warranty Registration Form and return to  
Crane Pumps & Systems, Inc. Warranty Service Group

If you have a claim under the provision of the warranty, contact your local  
Crane Pumps & Systems, Inc. Distributor.

FOLD HERE AND TAPE, DO NOT STAPLE

.....

**\*\* IMPORTANT! \*\***

**WARRANTY REGISTRATION**

**CUSTOMER'S NAME** \_\_\_\_\_ **DATE INSTALLED** \_\_\_\_\_

**ADDRESS** \_\_\_\_\_

**CITY** \_\_\_\_\_ **STATE** \_\_\_\_\_ **ZIP** \_\_\_\_\_

**PHONE #** \_\_\_\_\_ **FAX #** \_\_\_\_\_

**DEALER'S NAME** \_\_\_\_\_

**CITY** \_\_\_\_\_ **STATE** \_\_\_\_\_ **ZIP** \_\_\_\_\_

**MODEL NO.** \_\_\_\_\_ **SERIAL NO.** \_\_\_\_\_

**PART NO.** \_\_\_\_\_ **BRAND** \_\_\_\_\_

FOLD HERE AND TAPE, DO NOT STAPLE

---

PLACE  
STAMP  
HERE

**CRANE PUMPS & SYSTEMS, INC.  
WARRANTY SERVICE GROUP  
420 THIRD STREET  
PIQUA, OHIO  
45356 - U.S.A.**