

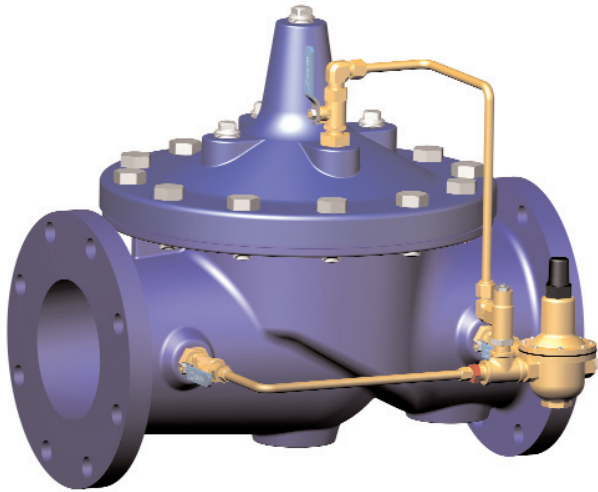

MODEL **90-01**
(Full Internal Port)
690-01
(Reduced Internal Port)

Pressure Reducing Valve



- Sensitive and Accurate Pressure Control
- Easy Adjustment and Maintenance
- Tamper Resistant
- Optional Check Feature
- Fully Supported Frictionless Diaphragm

The Cla-Val Model 90-01/690-01 Pressure Reducing Valve automatically reduces a higher inlet pressure to a steady lower downstream pressure, regardless of changing flow rate and/or varying inlet pressure. This valve is an accurate, pilot-operated regulator capable of holding downstream pressure to a pre-determined limit. When downstream pressure exceeds the pressure setting of the control pilot, the main valve and pilot valve close drip-tight.

If a check feature is added, and a pressure reversal occurs, the downstream pressure is admitted in the main valve cover chamber, closing the valve to prevent return flow.

Schematic Diagram

Item	Description
1	Hytrol (Main Valve)
2	X58 Restriction Fitting
3	CRD Pressure Reducing Control

Optional Features

Item	Description
A	X46A Flow Clean Strainer
B	CK2 (Isolation Valve)
C	CV Flow Control (Closing)*
D	Check Valves with Isolation Valve
S	CV Flow Control (Opening)
Y	X43 "Y" Strainer

*The closing speed control (optional) on this valve should always be open at least three (3) turns off its seat.

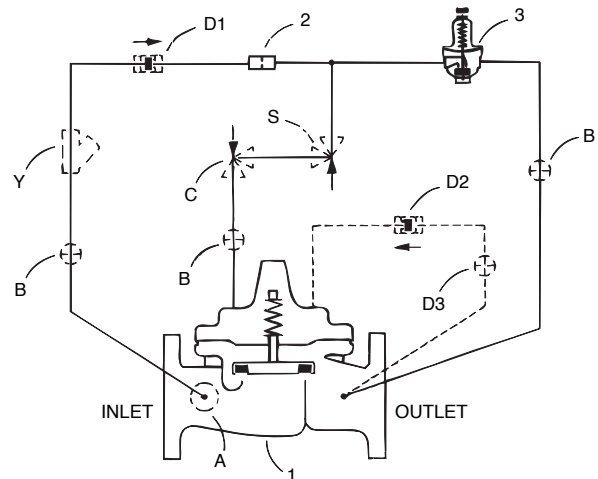

The "D" check feature on a vertically installed 6" and larger valves must be horizontally installed.

Typical Applications

Typical applications include pressure reducing valve station using Model 90-01BY/690-01BY and Model 90-01AS/690-01AS in parallel to handle wide range of flow rates. Larger Model 90-01BY/690-01BY valve meets requirements of peak loads and smaller Model 90-01AS/690-01AS handles low flows.

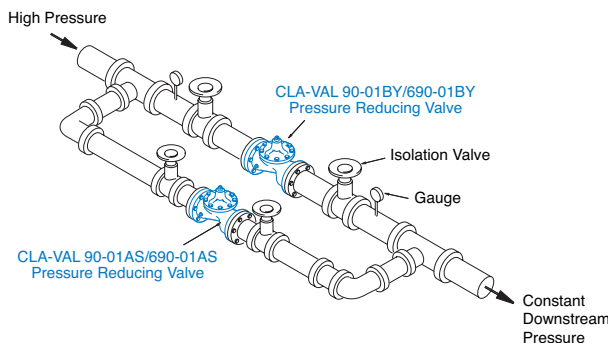

Cla-Val Model 90-01KO/690-01KO Pressure Reducing Valve with Anti-Cavitation Trim provides for optimum downstream pressure control while reducing noise and eliminating damage associated with cavitation.

See Cavitation Guide to determine if the valve is a candidate for the KO Anti-Cavitation Trim.

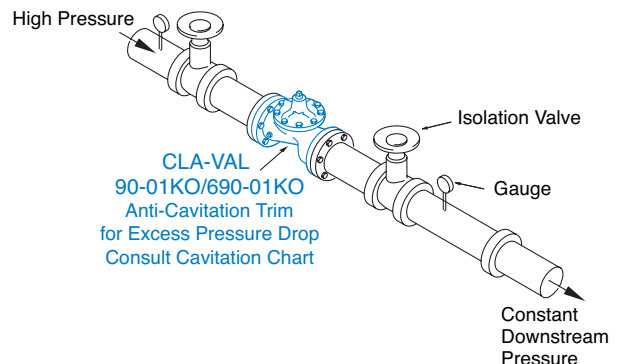

Model 90-01 (Uses Basic Valve Model 100-01)

Pressure Ratings (Recommended Maximum Pressure - psi)

Valve Body & Cover		Pressure Class			
		Flanged			Threaded
Grade	Material	ANSI Standards*	150 lb.	300 lb.	End** Details
ASTM A536	Ductile Iron	B16.42	250	400	400
ASTM A216-WCB	Cast Steel	B16.5	285	400	400
ASTM B62	Bronze	B16.24	225	400	400

Note: * ANSI standards are for flange dimensions only.
 Flanged valves are available faced but not drilled.
 ** End Details machined to ANSI B2.1 specifications.

Materials

Component	Standard Material Combinations		
Body & Cover	Ductile Iron	Cast Steel	Bronze
Available Sizes	1½" - 36"	1½" - 16"	1½" - 16"
Disc Retainer & Diaphragm Washer	Cast Iron	Cast Steel	Bronze
Trim: Disc Guide, Seat & Cover Bearing	Bronze is Standard Stainless Steel is Optional		
Disc	Buna-N® Rubber		
Diaphragm	Nylon Reinforced Buna-N® Rubber		
Stem, Nut & Spring	Stainless Steel		

For material options not listed, consult factory.
 Cla-Val manufactures valves in more than 50 different alloys.

Dimensions (In inches)

100-01 (Globe)

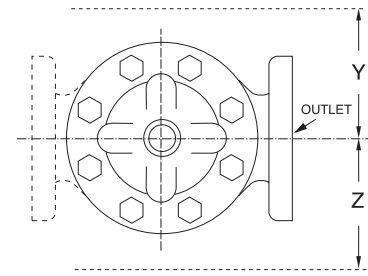
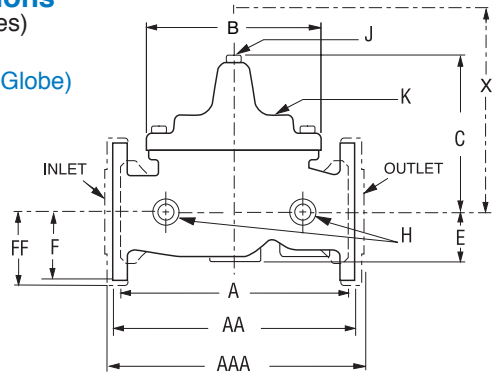

100-01 (Angle)

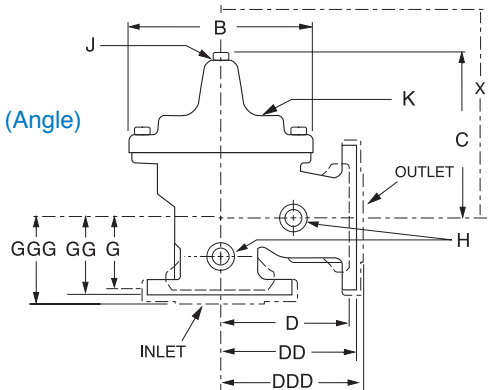

Model 90-01 Dimensions (In Inches)

Valve Size (Inches)	1½-1½	2	2 ½	3	4	6	8	10	12	14	16	24	36
A Threaded	7.25	9.38	11.00	12.50	—	—	—	—	—	—	—	—	—
AA 150 ANSI	8.50*	9.38	11.00	12.00	15.00	20.00	25.38	29.75	34.00	39.00	41.38	61.50	76.00
AAA 300 ANSI	9.00*	10.00	11.62	13.25	15.62	21.00	26.38	31.12	35.50	40.50	43.50	63.24	78.00
B Dia.	5.62	6.62	8.00	9.12	11.50	15.75	20.00	23.62	28.00	32.75	35.50	53.16	66.00
C Max.	5.50	6.50	7.56	8.19	10.62	13.38	16.00	17.12	20.88	24.19	25.00	43.93	61.50
D Threaded	3.25	4.75	5.50	6.25	—	—	—	—	—	—	—	—	—
DD 150 ANSI	4.00*	4.75	5.50	6.00	7.50	10.00	12.75	14.88	17.00	19.50	20.81	—	—
DDD 300 ANSI	4.25*	5.00	5.88	6.38	7.88	10.50	13.25	15.56	17.75	20.25	21.62	—	—
E	1.12	1.50	1.69	2.56	3.19	4.31	5.31	9.25	10.75	12.62	15.50	17.75	24.56
F 150 ANSI	2.50	3.00	3.50	3.75	4.50	5.50	6.75	8.00	9.50	10.50	11.75	19.25	28.00
FF 300 ANSI	3.06	3.25	3.75	4.13	5.00	6.25	7.50	8.75	10.25	11.50	12.75	—	—
G Threaded	1.88	3.25	4.00	4.50	—	—	—	—	—	—	—	—	—
GG 150 ANSI	4.00*	3.25	4.00	4.00	5.00	6.00	8.00	8.62	13.75	14.88	15.69	—	—
GGG 300 ANSI	4.25*	3.50	4.31	4.38	5.31	6.50	8.50	9.31	14.50	15.62	16.50	—	—
H NPT Body Tapping	¾	¾	½	½	¾	¾	1	1	1	1	1	1	2
J NPT Cover Center Plug	¼	½	½	½	¾	¾	1	1	1¼	1½	2	1½	2
K NPT Cover Tapping	¾	¾	½	½	¾	¾	1	1	1	1	1	1	2
Valve Stem Internal Thread UNF	10-32	10-32	10-32	¼-28	¼-28	¾-24	¾-24	¾-24	¾-24	¾-24	¾-24	½-20	¾-16
Stem Travel	0.4	0.6	0.7	0.8	1.1	1.7	2.3	2.8	3.4	4.0	4.5	6.75	10.12
Approx. Ship Wt. Lbs.	15	35	50	70	140	285	500	780	1165	1600	2265	6200	11470
X Pilot System	11.00	13.00	14.00	15.00	17.00	29.00	31.00	33.00	36.00	40.00	40.00	68.00	86.00
Y Pilot System	9.00	9.00	10.00	11.00	12.00	20.00	22.00	24.00	26.00	29.00	30.00	39.00	45.00
Z Pilot System	9.00	9.00	10.00	11.00	12.00	20.00	22.00	24.00	26.00	29.00	30.00	39.00	45.00

*1½" Size Only

Model 690-01 (Uses Basic Valve Model 100-20)

Dimensions (In inches)

Pressure Ratings (Recommended Maximum Pressure - psi)

Valve Body & Cover		Pressure Class		
		Flanged		
Grade	Material	ANSI Standards*	150 lb.	300 lb.
ASTM A536	Ductile Iron	B16.42	250	400
ASTM A216-WCB	Cast Steel	B16.5	285	400
ASTM B62	Bronze	B16.24	225	400

Note: *ANSI standards are for flange dimensions only.
Flanged valves are available faced but not drilled.

100-20 (Globe)

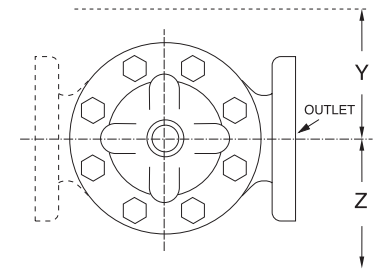
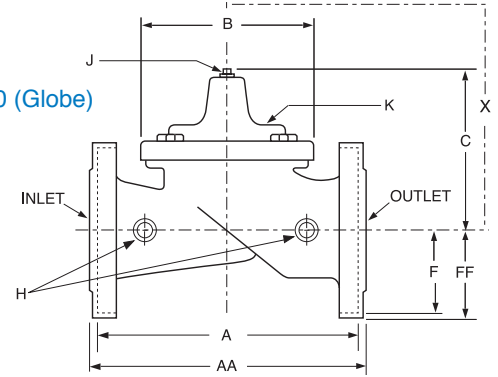

100-20 (Angle)

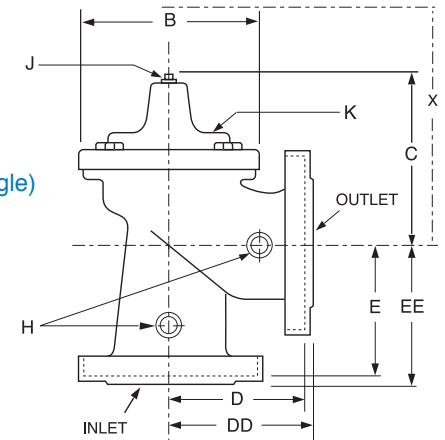



















































Materials

Component	Standard Material Combinations		
Body & Cover	Ductile Iron	Cast Steel	Bronze
Available Sizes	3" - 48"	3" - 16"	3" - 16"
Disc Retainer & Diaphragm Washer	Cast Iron	Cast Steel	Bronze
Trim: Disc Guide, Seat & Cover Bearing	Bronze is Standard Stainless Steel is Optional		
Disc	Buna-N® Rubber		
Diaphragm	Nylon Reinforced Buna-N® Rubber		
Stem, Nut & Spring	Stainless Steel		

For material options not listed, consult factory.
Cla-Val manufactures valves in more than 50 different alloys.

Model 690-01 Dimensions (In Inches)

Valve Size (Inches)	3	4	6	8	10	12	14	16	18	20	24	30
A 150 ANSI	10.25	13.88	17.75	21.38	26.00	30.00	34.25	35.00	42.12	48.00	48.00	63.25
AA 300 ANSI	11.00	14.50	18.62	22.38	27.38	31.50	—	36.62	43.63	49.62	49.75	—
B Dia.	6.62	9.12	11.50	15.75	20.00	23.62	28.00	28.00	35.44	35.44	35.44	53.19
C Max.	7.00	8.62	11.62	15.00	17.88	21.00	20.88	25.75	25.00	31.00	31.00	43.94
D 150 ANSI	—	6.94	8.88	10.69	—	—	—	—	—	—	—	—
DD 300 ANSI	—	7.25	9.38	11.19	—	—	—	—	—	—	—	—
E 150 ANSI	—	5.50	6.75	7.25	—	—	—	—	—	—	—	—
EE 300 ANSI	—	5.81	7.25	7.75	—	—	—	—	—	—	—	—
F 150 ANSI	3.75	4.50	5.50	6.75	8.00	9.50	11.00	11.75	15.88	14.56	17.00	19.88
FF 300 ANSI	4.12	5.00	6.25	7.50	8.75	10.25	—	12.75	15.88	16.06	19.00	—
H NPT Body Tapping	3/8	1/2	3/4	3/4	1	1	1	1	1	1	1	1
J NPT Cover Center Plug	1/2	1/2	3/4	3/4	1	1	1 1/4	1 1/4	2	2	2	2
K NPT Cover Tapping	3/8	1/2	3/4	3/4	1	1	1	1	1	1	1	1
Valve Stem Internal Thread UNF	10-32	1/4-28	1/4-28	3/8-24	3/8-24	3/8-24	3/8-24	3/8-24	1/2-20	1/2-20	1/2-20	3/4-16
Stem Travel	0.6	0.8	1.1	1.7	2.3	2.8	3.4	3.4	3.4	4.5	4.5	6.5
Approx. Ship Wt. Lbs.	45	85	195	330	625	900	1250	1380	1500	2551	2733	6500
X Pilot System	13.00	15.00	27.00	30.00	33.00	36.00	36.00	41.00	40.00	46.00	55.00	68.00
Y Pilot System	10.00	11.00	18.00	20.00	22.00	24.00	26.00	26.00	30.00	30.00	30.00	39.00
Z Pilot System	10.00	11.00	18.00	20.00	22.00	24.00	26.00	26.00	30.00	30.00	30.00	39.00

Valve Selection		These Symbols  and  Indicate Available Sizes																	
		Inches	1¼	1½	2	2½	3	4	6	8	10	12	14	16	18	20	24	30	36
		mm	32	40	50	65	80	100	150	200	250	300	350	400	450	500	600	750	900
		End Detail	Threaded	Threaded & Flanged					Flanged										
Model 90-01	Basic Valve 100-01	Globe																	
		Angle																	
	Suggested Flow (gpm)	Max. Continuous	93	125	210	300	460	800	1800	3100	4900	7000	8400	11000			25000		50000
		Max. Intermittent	120	160	260	370	580	990	2250	3900	6150	8720	10540	13700			31300		62500
		Min. Continuous	10	10	15	20	30	50	115	200	300	400	500	650			1750		2900
	Suggested Flow (Liters/Sec)	Max. Continuous	6	8	13	19	29	50	113	195	309	441	529	693			1575		3150
		Max. Intermittent	7.6	10.1	16.4	23	37	62	142	246	387	549	664	863			1972		3940
		Min. Continuous	.6	.6	.9	1.3	1.9	3.2	7.2	13	19	25	32	41			110		180
	Model 690-01	Basic Valve 100-20	Globe																
Angle																			
Suggested Flow (gpm)		Max. Continuous					260	580	1025	2300	4100	6400	9230	9230	16500	16500	16500	28000	
		Min. Continuous					15	30	50	115	200	300	500	500	900	900	900	1850	
Suggested Flow (Liters/Sec)		Max. Continuous					16	37	65	145	258	403	581	581	1040	1040	1040	1764	
		Min. Continuous					.9	1.9	3.2	7.2	13	19	32	32	57	57	57	117	

690-01 is the reduced internal port size version of the 90-01.

**Flanged End Detail Only

For 100-01 basic valves, suggested flow calculations were based on flow through Schedule 40 Pipe. Maximum continuous flow is approx. 20 ft/sec (6.1 meters/sec) & maximum intermittent is approx. 25 ft/sec (7.6 meters/sec) and minimum continuous flow is approx. 1 ft/sec (.3 meters/sec). For 100-20 basic valves, suggested flow calculations were based on flow through the valve seat. Approx. 26 ft/sec (7.9 meters/sec) was used for maximum continuous flow & 1 ft/sec (.3 meters/sec) is used for minimum continuous flow. Maximum continuous flow through the valve seat for the 30" 100-20 is approx. 20 ft/sec (6.1 meters/sec).

Many factors should be considered in sizing pressure reducing valves including inlet pressure, outlet pressure and flow rates. For sizing questions or cavitation analysis, consult Cla-Val with system details.

Pilot System Specifications

Adjustment Ranges

2 to 30 psi
 15 to 75 psi
 20 to 105 psi
 30 to 300 psi*

*Supplied unless otherwise specified
 Other ranges available, please consult factory

Temperature Range

Water: to 180°F

Materials

Standard Pilot System Materials

Pilot Control: Bronze ASTM B62
 Trim: Stainless Steel Type 303
 Rubber: Buna-N® Synthetic Rubber

Optional Pilot System Materials

Pilot Systems are available with optional Aluminum, Stainless Steel or Monel materials at additional cost.

Note: Available with remote sensing control.

When Ordering, Please Specify

1. Catalog No. 90-01 or No. 690-01
2. Valve Size
3. Pattern - Globe or Angle
4. Pressure Class
5. Threaded or Flanged
6. Trim Material
7. Adjustment Range
8. Desired Options
9. When Vertically Installed



CLA-VALTM

E-90-01/690-01 (R-9/06)

CLA-VAL

PO Box 1325 Newport Beach CA 92659-0325
 Phone: 949-722-4800 • Fax: 949-548-5441

CLA-VAL CANADA

4687 Christie Drive
 Beamsville, Ontario
 Canada LOR 1B4
 Phone: 905-563-4963
 Fax: 905-563-4040

CLA-VAL EUROPE

Chemin des Mesanges 1
 CH-1032 Romanel/
 Lausanne, Switzerland
 Phone: 41-21-643-15-55
 Fax: 41-21-643-15-50

©COPYRIGHT CLA-VAL 2006 Printed in USA
 Specifications subject to change without notice.

www.cla-val.com

Represented By: