

MXCORE-UH

Expandable HDMI 32x32 Matrix Over Cat5e/6



MXCore-Ultra HDMI is an expandable HDMI video router, capable of routing 1080p signals in configurations of 4x4 up to 32x32 over Cat5e/6

FEATURES

- Switches any HDMI source input to any output up to 32x32
- Sources can be routed independently to any display
- Supports high definition video resolutions of 480p, 720p, 1080i and 1080p
- Supports digital formats in Deep Color to 12bit per color
- Supports EDID for total control of compliant displays
- Delivers uncompressed digital video with zero signal loss
- Input cable equalization
- Switching controlled via RS-232, IR, Smart Control GUI or web server
- Front panel 4x40 LCD display
- Easy switching via front panel
- Browser Graphical User Interface (GUI)
- Web-based interface
- Telnet support
- Firmware upgradeable for future support
- Extends HDMI, IR output over single Cat5/5e/6UTP cable
- Extends IR and signals for remote control
- Data signals up to 3.4 Gbps
- Support RC5 IR for local switching
- Support IR bypass for 36 to 60Khz



THE MATRIX

The MXCore-UH is an HDMI video router that enables users to route HD signals up to 425 feet over a single CAT 5e/6 cables, providing the ultimate solution to create clean and efficient video and digital signage systems in configurations up to 32x32.

Pristine video has become the standard for entertainment, video systems and digital signage, but HDMI video routing has been confined by the necessity of short, bulky and unsightly cables. The MXCore-UH, utilizing HDBaseT technology, breaks the distance limits that have tethered users as it facilitates the routing of crystal clear 1080p HD video, multi-channel audio, Ethernet, IR and power up to an incredible 425 feet through the use of inexpensive CAT 5e/6 cables. With unprecedented flexibility and convenience, the MXCore-UH is overhauling the old challenges of HD Matrix routers with an elegant and easy-to-install solution.

The MXCore-UH can direct as many as 32 HD inputs and 32 HD outputs effortlessly. Routing HDMI signals across long distances from the user-friendly MXCore-UH exponentially increases users' ability to create the ideal digital video experience in any environment.

The MXCore-UH gives users the option of remotely switching the source – the primary function of a video router– as well as controlling the input sources, all from one device. Thanks to reliable CAT 5e/6 connections, it's never been easier to manage signal switching and the sources being switched all from a single control. This additional functionality allows for superior routing and viewing in contexts like home entertainment, digital signage, medical systems, live events and countless other venues.

APPLICATIONS

- Wall Displays
- Digital Signage
- Airports
- Dealer Rooms
- Control Rooms
- Audio/Visual Presentations
- Shopping Centers
- Security
- Point-of-Sale
- Hotels/Resorts
- KVM Switch

HDMI MATRIX SWITCHING MADE EASY

Users can locally switch between sources via the easy-to-operate front panel, or they can do so remotely through a RS-232, IR, or TCP/IP connection. The MXCore-UH can be controlled by SmartAVI's very own Windows®-based manager software, a cornerstone of all SmartAVI products.

FLEXIBLE CONTROL

Front Panel -MXCore-UH by SmartAVI can be controlled from the easily accessible LCD front panel and keypad that allows users to determine which inputs are connected to which outputs.

RS-232 - Controlling the MXCore-UH Matrix Switchers is effortless with SmartAVI's Windows®-based SmartControl software. Users can assign a unique name to each port on the Matrix along with a display for specific project requirements. While all the functions of the Matrix are available locally on the front panel, SmartControl allows customization of all the Matrix's functions.

IR -Many system professionals prefer the IR control interface because it offers greater flexibility to manage the MXCore-UH at a distance. In some cases, the displays will not be visible from the Matrix, which would then make it necessary to control the Matrix with Infrared command signals.

TCP/IP - If users need to make changes instantly but can't be there in person, the Net-IP-Pro control module is the solution. SmartAVI's optional Net-IP-Pro module is effective for real-time remote control management. Simply connect the Net-IP-Pro module to the MXCore-UH Matrix while connected to the Internet and the Matrix can be controlled from anywhere in the world.

EDID EMULATION

Each input incorporates our unique "SmartEDID" programmable technology capable of learning video resolutions, audio settings and 3D data. The EDID memory of each display is stored in a single flash memory, giving users freedom to choose any EDID and emulation of any display.

The MXCore-UH enables HDMI sources to continuously read the EDID of a monitor with full emulation at any given time.

The EDID management allows learning and saving of up to 100 displays, including audio. The MXCore-UH Series can learn EDID from any display device provided.

SWITCHING INPUTS WITH REMOTE CONTROL

Users can easily control the MXCore-UH Matrix via the SmartAVI remote control. The remote utilizes Philips RC5 IR transmission protocol and these signals can be used to switch inputs on the MXCore-UH. This handy feature gives users the freedom of remotely selecting inputs on the fly.

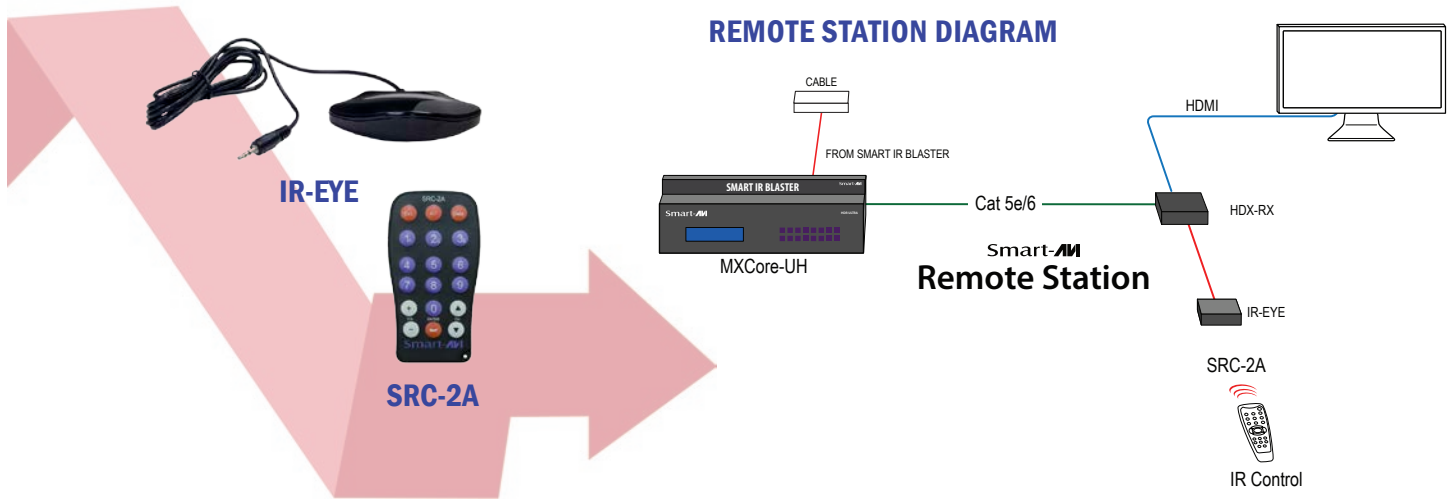

CONTROL DEVICES WITH IR-BLASTER

In addition to controlling the matrix itself, the IR-Blaster can also be used to control input devices, like HDTV boxes, Blu-ray players and more. This handy device enables users to use the device's native remote control, routing the remote's infrared signal back to the device for instantaneous control. That makes it easy for users to have complete flexibility and control over all the connected input devices from the location of the screens, rather than tracking down the matrix and the input devices to make changes.

SMART IR-BLASTER

Front

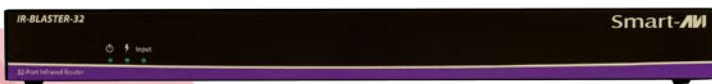

Back



SMART IR-BLASTER DIAGRAM

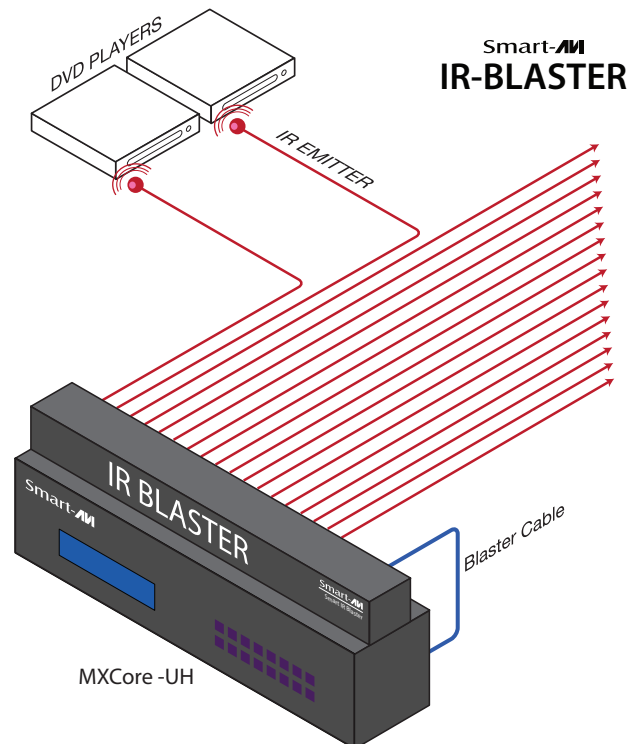

SMARTAVI OFFERS MULTIPLE SOLUTIONS CONTROL THE MXCORE-UH SERIES

- Windows application
- Web based application
- Front panel switches and LCD
- Easy protocol for integration with the most common control systems such as: AMX, Creston, and more.

SMARTCONTROL



SmartControl is the Windows GUI application that enables users to control SmartAVI Matrix using graphic user interface without having to write the codes and send serial commands to the devices.

The software allows configuration of the size and type of the Matrix, including a preset defined at macro.

The software also enables identification by name for each source and display.

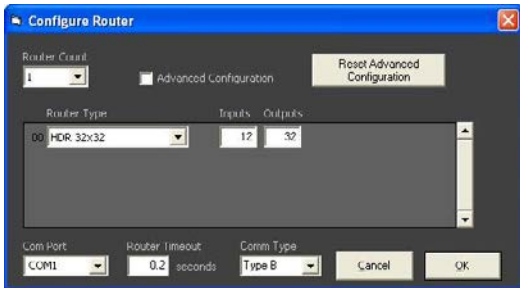

NET-IP-PRO



Net-IP-Pro gives the user full control of the Matrix from anywhere in the world through this advanced new web browser software.

Net-IP-Pro enables multiple users to control and configure the Matrix, including names of sources, names of displays, IP addresses and low level features of the Matrix.

The Net-IP-Pro enables the support of telnet for easy integration with other control systems.

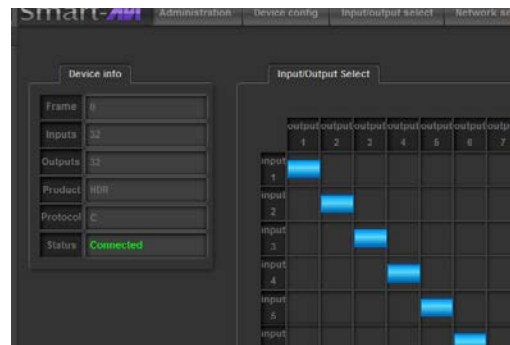

FRONT PANEL

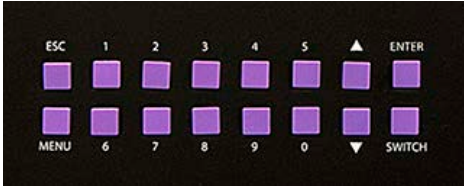

The MXCore-UH front panel enables one to switch directly from the Matrix without the use of any software.



Its LCD (4x40) offers detailed information about the status of the switch at any given moment.

HDX-MX RECEIVER



HDX-MX DIAGRAM

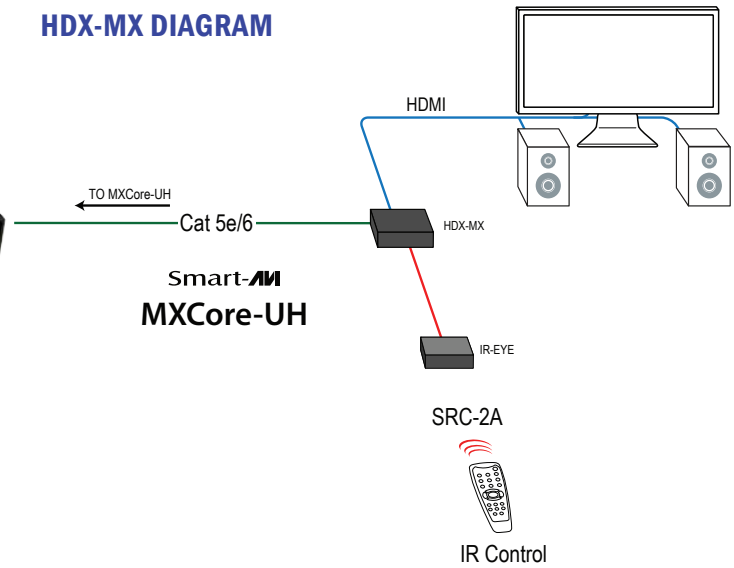

HDX-MX Technical Specifications

VIDEO	
Format	HDMI 1.3 and HDCP compliant
HDTV Resolutions	480p, 720p, 1080i, 1080p/60Hz/48bit
TV Resolution	480i
Input Interface (TX)	HDMI
Output Interface (RX)	HDMI
Input Cable Length (TX)	Up to 40 ft.
Output Cable Length (RX)	Up to 40 ft.
IR	
Signal Type	38 KHz
Interface	3.5 mm Jack Socket (Female)
SYSTEM	
Interface	RJ-45
Cable Requirements	CAT5/5e/6

OTHER	
Power	External 100-240 VAC/5VDC2A @10W
Dimensions	5"W x 1.125"H x 4.125"D
Weight	0.6 lbs.
Approvals	UL, CE, ROHS Compliant
Operating Temp.	32-131°F (0-55 °C)
Storage Temp.	-4-185 °F (-20-85 °C)
Humidity	Up to 95%

FRONT AND BACK

MXCore-UH Front

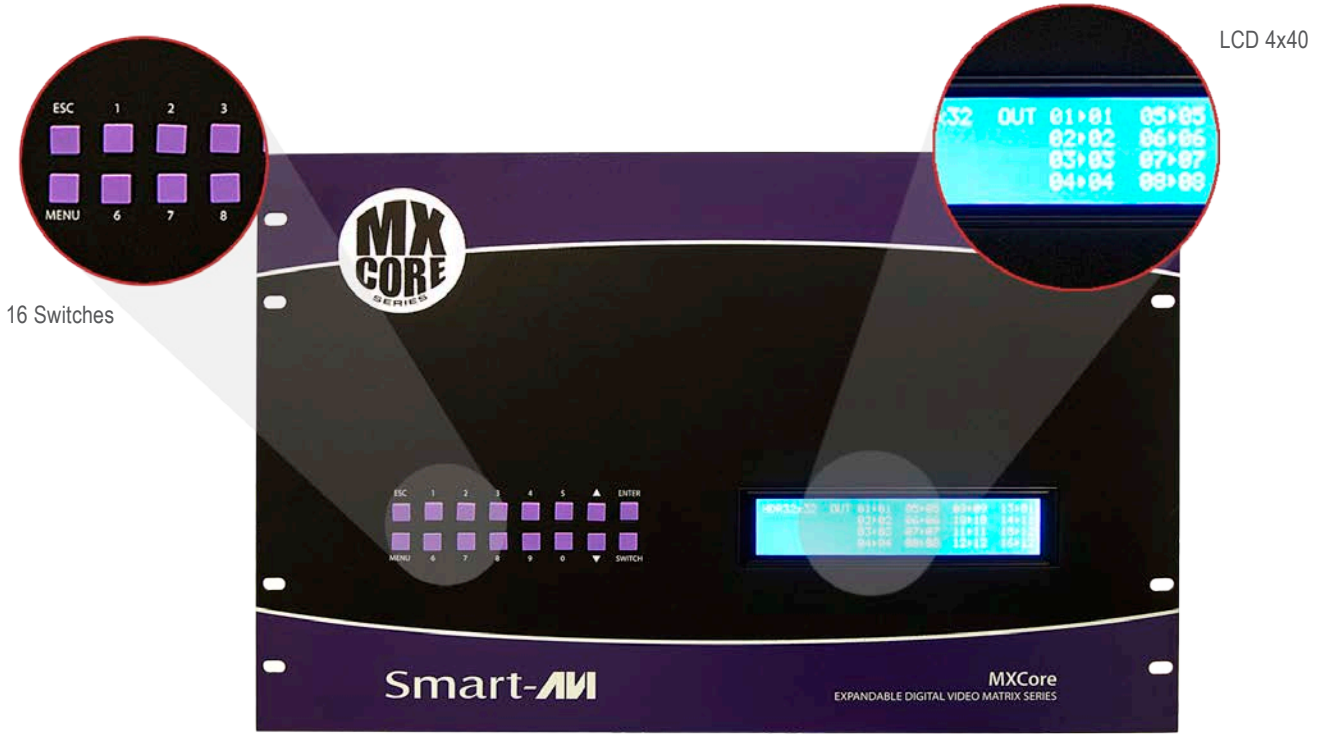

MXCore-UH Back

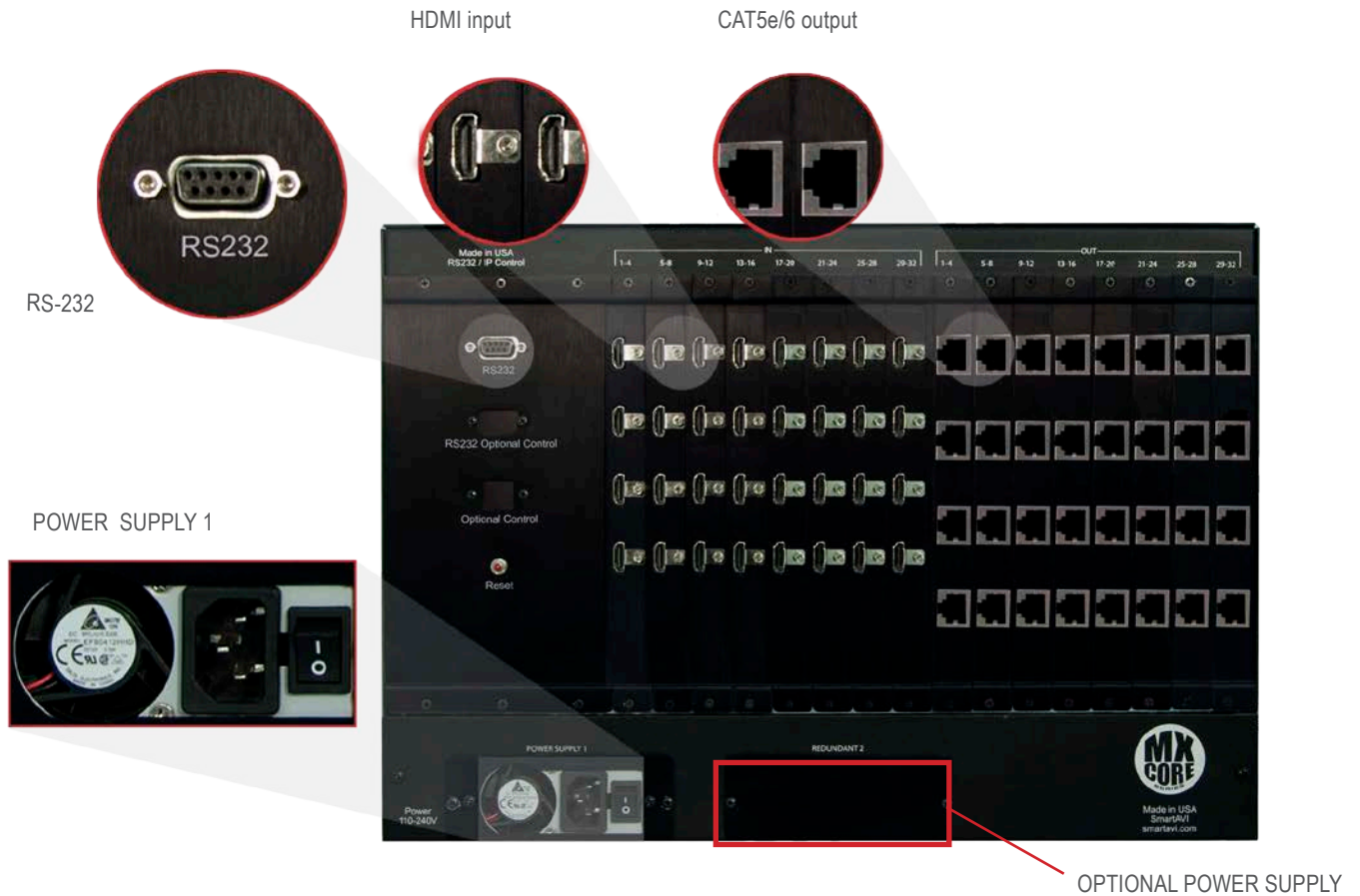

MXCore-UH Front



MXCore-UH Back



APPLICATION DIAGRAM

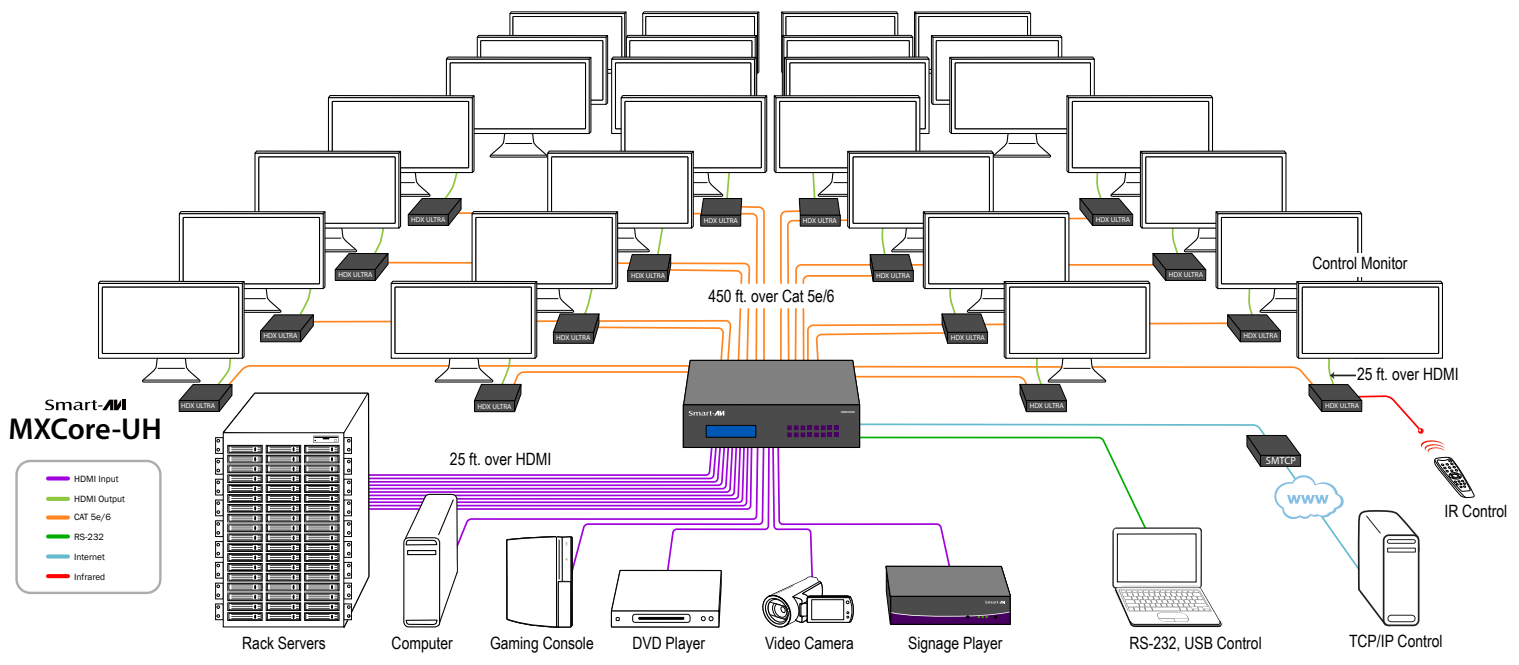

SPECIFICATIONS



MXCore-UH Input Card

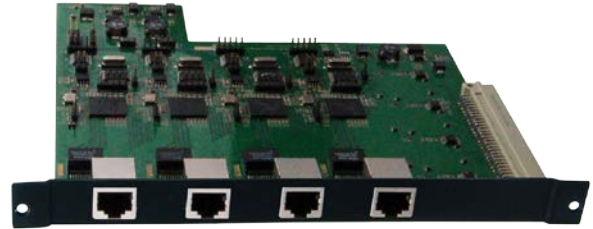

MXCore-UH Output Card

VIDEO

Video Amplifier Bandwidth	3.2G
Input Video Signal	Video (TMDS) 0.5~1.0Vpp
Input DDC Signal	5 volts
Signal Supports	HDMI and HDCP compliant
Pixel Rates	Clock frequency beyond 165Mpix/second
Format	4:4:4 and 4:2:2 data input formats
Resolution	480p, 720p, 1080i, 1080p
Input Cards	HDMI
Output Cards	4x CAT5e/6
Input Slots	Up to 8 cards of 4 HDMI input each
Output Slots	Up to 8 cards of 4 CAT5e/6 output each
Video Type	RGB/YCBCR : 24/30/36-bits, YCBCR: 8/10/12/16/20/24-bits

CONTROLS

IR	38Khz RC5
Front	2x8 keyboard with 4x40 LCD
RS232	9600bps, Software flow DB9 Female
TCP/IP	Webserver, Telnet

OTHER

Working Temperature	0°C~+55°C
Storage Humidity	10%~90%
Weight	20 lbs.
Dimensions	17.125W x 12H x 12D in
Power Supply	50/60Hz, 100~230 VAC
Consumption	300W

ORDERING INFORMATION

Part No.	Description
MXC-UH08X16S	MXCORE-UH Expandable HDMI 8X16 Matrix Switcher. Includes: [MXC-UH08X16, SM-CSW, and CCPWR06]
MXC-UH08X32S	MXCORE-UH Expandable HDMI 8X32 Matrix Switcher. Includes: [MXC-UH08X32, SM-CSW, and CCPWR06]
MXC-UH12X16S	MXCORE-UH Expandable HDMI 12X16 Matrix Switcher. Includes: [MXC-UH12X16, SM-CSW, and CCPWR06]
MXC-UH12X32S	MXCORE-UH Expandable HDMI 12X32 Matrix Switcher. Includes: [MXC-UH12X32, SM-CSW, and CCPWR06]
MXC-UH16X08S	MXCORE-UH Expandable HDMI 16X8 Matrix Switcher. Includes: [MXC-UH16X08, SM-CSW, and CCPWR06]
MXC-UH16X12S	MXCORE-UH Expandable HDMI 16X12 Matrix Switcher. Includes: [MXC-UH16X12, SM-CSW, and CCPWR06]
MXC-UH16X16S	MXCORE-UH Expandable HDMI 16X16 Matrix Switcher. Includes: [MXC-UH16X16, SM-CSW, and CCPWR06]
MXC-UH16X32S	MXCORE-UH Expandable HDMI 16X32 Matrix Switcher. Includes: [MXC-UH16X32, SM-CSW, and CCPWR06]
MXC-UH32X08S	MXCORE-UH Expandable HDMI 32X8 Matrix Switcher. Includes: [MXC-UH32X08, SM-CSW, and CCPWR06]
MXC-UH32X12S	MXCORE-UH Expandable HDMI 32X12 Matrix Switcher. Includes: [MXC-UH32X12, SM-CSW, and CCPWR06]
MXC-UH32X16S	MXCORE-UH Expandable HDMI 32X16 Matrix Switcher. Includes: [MXC-UH32X16, SM-CSW, and CCPWR06]
MXC-UH32X32S	MXCORE-UH Expandable HDMI 32X32 Matrix Switcher. Includes: [MXC-UH32X32, SM-CSW, and CCPWR06]
SM-MXU-EYE	External Infrared Receiver for MXCore
RMT-MXU	IR Remote Control for MXCore
SM-MXU-LED	IR Emitter 6' Single LED for MXCore
IRB-MXU-32PS	IR-Blaster: 32-Port IR Router for MXCore-Ultra. Includes: [IRB-MXU-32P, 32 x SM-MXU-LED, and PS5VD4A]
HDX-MXUH-RXS	HDBaseT HDMI + IR + RS232 CAT5 STP Extender Receiver for MXCore-UH. Includes: [HDX-MXUH-RX and PS5VD2A]



Designed and Manufactured in the USA

www.smartavi.com

Tel: 800.AVI.2131 • 818.503.6200 • 11651
Vanowen St. North Hollywood, CA. 91605

Smart-AVI
SMART AUDIO VIDEO INNOVATION