

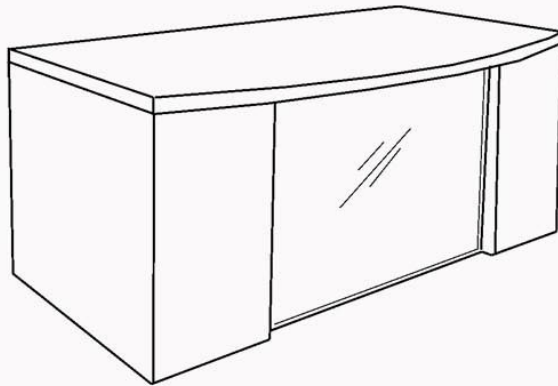

Modern Office
6900 Shady Oak Road, Ste 120
Eden Prairie, MN 55344
Phone: 800.443.5117
(In MN): 952.941.2837
Fax: 952.949.9816
www.modernofficefurniture.com

Glass Front Desk

MJ/FL/ML/WH Bowtop+Glass/
RTPED / LFTPED



ASSEMBLY INSTRUCTIONS

PARTS LIST

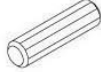
Part	Part
 Wood Dowel	 Cap
 Cam Pin	 Leveling Glide
 Cam Lock	 Grommet
 Screw	

Assemble on a smooth, carpeted floor to prevent scratches or damage.
Assembly will require 2 people for safety.

If assembling executive desk:

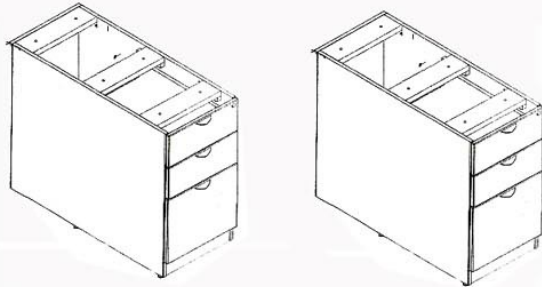

Step 1: Attach leveling glides and drawer pulls to pedestals

If assembling an L or U Desk

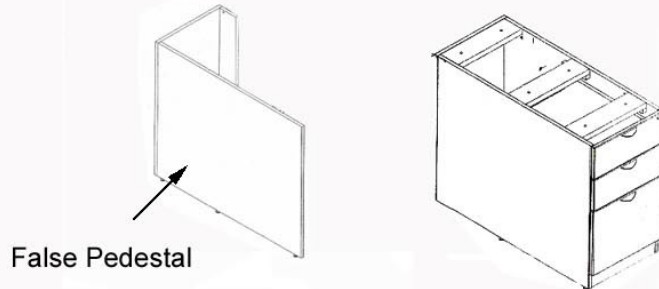

False Pedestal

Step 1: Assemble false pedestal using cam locks and pins provided. Then attach drawer pulls and leveling glides to pedestal. Attach leveling glides to false pedestal as well.

If assembling executive desk:

Step 2: Place pedestals so that the predrilled holes along the side face each other. Attach glass panels using round head screws provided. Reach into the open area behind the drawers inside the file to insert the screws through the side of the file into the glass panels. Bring the pedestals in as close as possible for a tight fit. Glass Panel will have threaded holes to receive the screws.

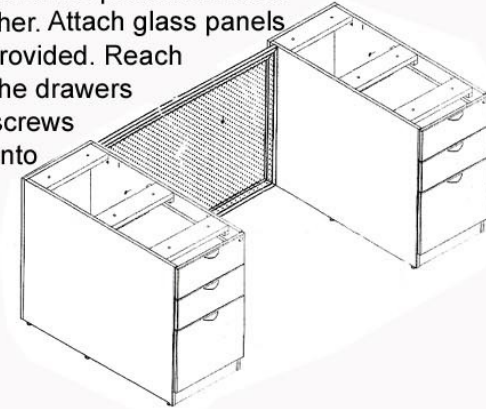

If assembling an L or U Desk

Step 2: Same procedure except one side will be the false pedestal and the other side is the file. False pedestal attaches using same screws as pedestal.

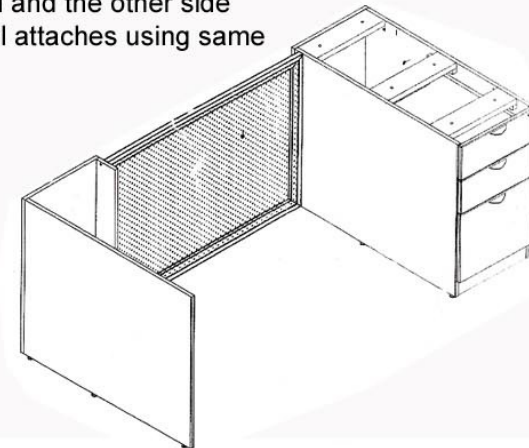

Step 3: Attach desktop to pedetals using cam pins, cam locks and wooden dowels provided.

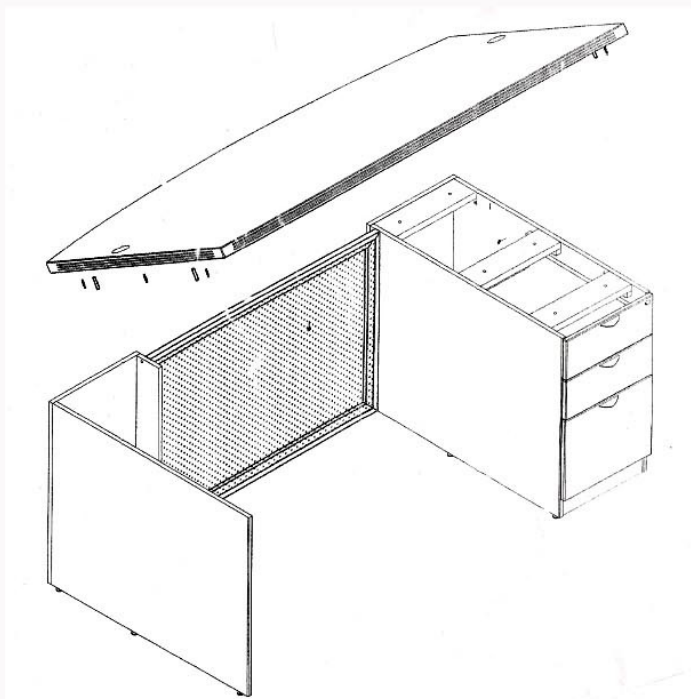

Step 4: Attach file pedestal(s) to desktop using the 6 bolts provided.





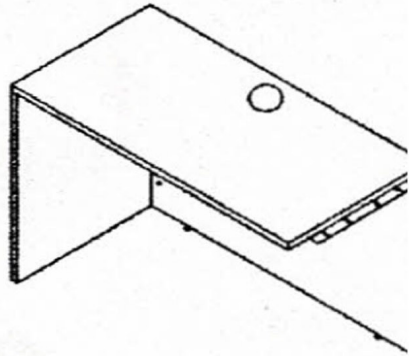





Step 5: Insert grommets.

Reversible Desk Return MJ/FL/ML/WH2045

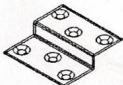

ASSEMBLY INSTRUCTIONS

PARTS LIST

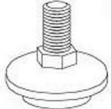
Part	Part	Part
 Wood Dowel	 Shallow Cover	 Worksurface Bracket
 Cam Pin	 Deep Cover	 Side Panel Brackets (2)
 Cam Lock	 Grommet	 M6 Screw
 Wood Screw	 L-Bracket	 Leveling Glide



Modern Office
6900 Shady Oak Road, Ste 120
Eden Prairie, MN 55344
Phone: 800.443.5117
(In MN): 952-941-2837
Fax: 952.949.9816
www.modernofficefurniture.com

Left Return

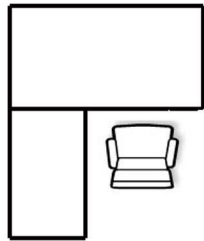

Right Return

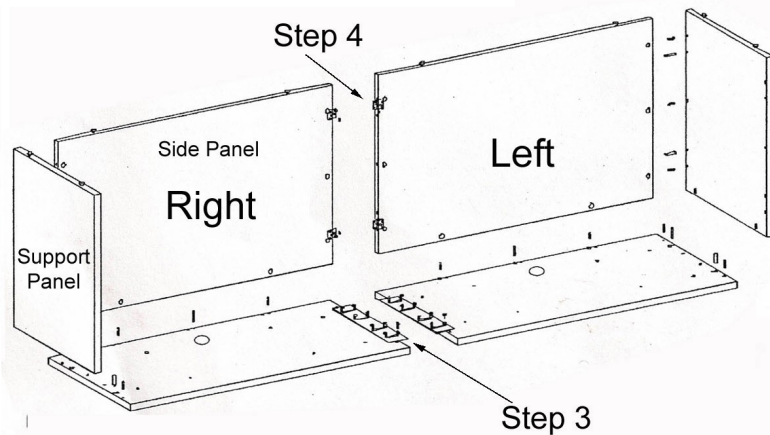
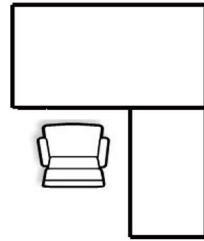

Assemble upside down in carpeted area

Step 1:
Determine if return desk is to be Left or Right.

Step 2:
Attach Side Panel and Support Panel using dowels, cam locks and cam pins provided.

Step 3:
Using M6 Screws, attach flat bracket to edge of return as shown in the photo, centering it over the edge.

Step 4:
Using wood screws provided, attach both side panel offset brackets to the side panel as shown.

Step 5:
Screw in floor glides.

Step 6:
Carefully turn over return desk and attach to main desk using M6 screws, connecting other side of flat bracket to underside of main desk

Step 7:
Insert grommet and covers. Shallow covers go over cams on side panel, deep covers go over cams on support panel, since those are more inset.



Box/Box/File Pedestal

MJ/FL/ML/WH2066



Install Instructions

PARTS LIST

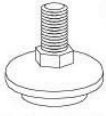
Part	Part
 Bolt	 Drawer Pull & Screws
 Keys	 Leveling Glide

- 1) Install 4 leveling glides and level the file
- 2.) Install drawer pulls with screws provided.

To attached under desk (optional):

- 1.) Remove 1 or 2 of the box drawers by locating the black tabs in the left & right side of the drawer. Pull up on one tab, push down on the other to unlock from the track and remove drawer.
- 2.) Use 4 bolts provided to go through the top of the file into the threaded holes on the underside of the desk.