

Peninsula Desk Assembly Instructions

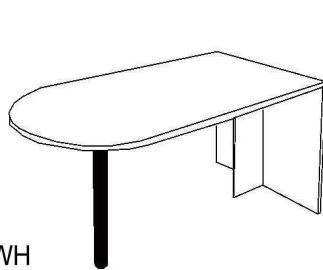

MJ/ML/WH
Cherry/Maple/White Peninsula Desk

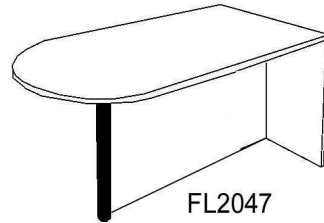

FL2047
Mocha Peninsula Desk

Applies to:
(BK/CH/MJ/ML/MWAL/WH)2047

List of Hardware:

Part	Part
 Wood Dowel	 Cap
 M6 Screw	 Leveling Glide
 Cam Lock & Pin Set	

- 1.) Assemble on carpet or cardboard to protect parts during assembly. Assembly will require 2 people for safety.
- 2.) Locate Post Leg. (You may need to tighten the connecting plate by tightening the screw inside the leg). Using the 4 M6 Machine Screws provided and screw the top of the leg into the underside of the peninsula desktop. The holes are piloted.
- 3.) Next, insert all dowels, cam pins and cam locks into the desktop, Side Panel and Support.
- 4a) If you have a Charcoal, Cherry, Maple or White Peninsula Desk, attach the Support and Side Panel together. Insert the dowels and cam pins into the corresponding holes and twist the cam locks with your screwdriver to secure (Fig. 1)
- 4b) If you have a Mocha Peninsula Desk, Attach the Support to the Post leg and Desktop first.

Tools Needed:

- Phillips Screwdriver
- A helper!

Special Note:

Location & number of cam pin, cam lock and dowel holes may vary.

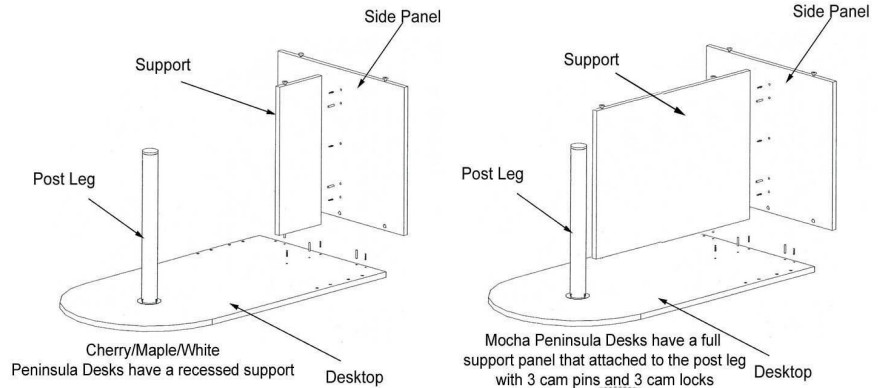
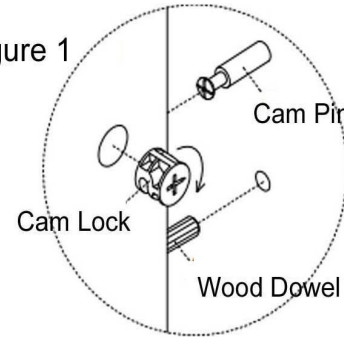

Figure 1



- 5a) If you have Charcoal, Cherry, Maple or White Peninsula Desk, your next step will be to attach the Support/Side Panel assembly to the desktop using the same hardware method.
- 5b) If you have a Mocha Peninsula Desk, your next step will be to attach the Side Panel to the Support and Desktop.
- 6) Insert all Leveling Glides and with a helper, carefully turn the desk upright.
- 7) Once in place, cover all Cam Locks with the Caps provided.

Questions? Please call 1-800-443-5117.

Customer Service available 8:30 - 5:00 Central Time, Monday - Friday

Desk/Credenza Shell Assembly Instructions

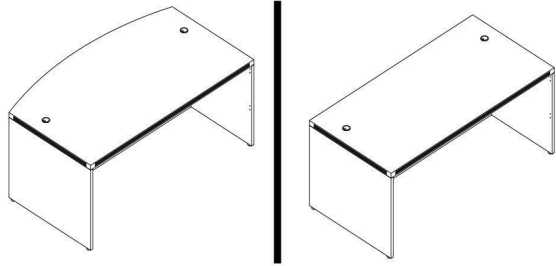

Applies to:

(BK/CH/MJ/ML/MWAL/WH) 2001/2002/2043/2089/3624/7124

List of Hardware:

Part	Part
 Wood Dowel	 Cap
 Cam Pin	 Leveling Glide
 Cam Lock	 Grommet

Tools Needed:

- Phillips Screwdriver
- A helper!

- 1.) Assemble on carpet or cardboard to protect parts during assembly. Assembly will require 2 people for safety.
- 2.) Locate left & right side panels. Screw in the leveling glides by hand. Then, insert wood dowels & cam pins. The wood dowels fit into the slightly larger holes, compared to the cam pin holes
- 3.) Locate front panel and insert all cam locks on the left & right sides. Then, align one of the side panels and connect the panel by inserting the cam pins into the cam locks and the dowels into the corresponding holes. (see diagram on next page). Twist the cam locks with a Phillips Screwdriver to secure.

Special Note:

Location & number of cam pin, cam lock and dowel holes may vary.

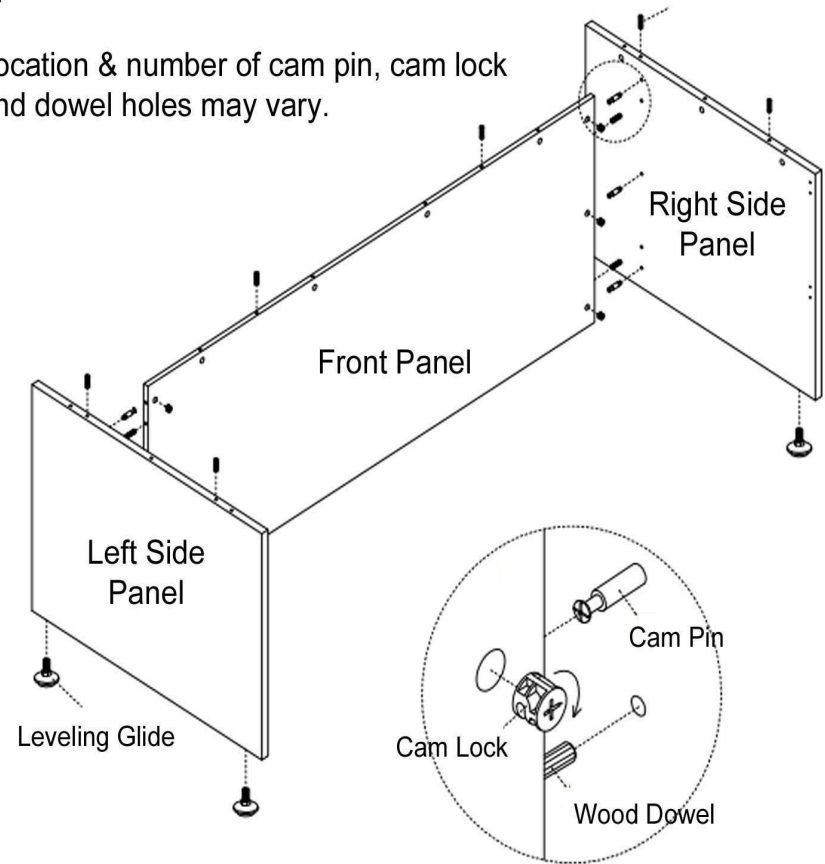

- 4.) Next, insert all cam pins, dowels and cam locks on the top edges of the side panels and front panels. Locate the desktop and with a helper, carefully set the desktop on top of the assembly shown above. Twist cam locks to secure the connection.
- 5.) Your last step is to insert the grommet(s) provided into the desktop. Cover the cam locks with the caps provided.

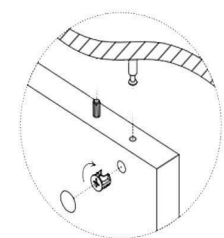
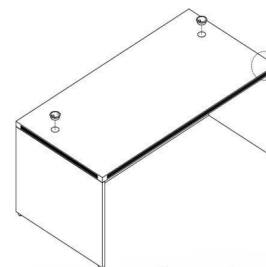

Questions? Please call 1-800-443-5117.





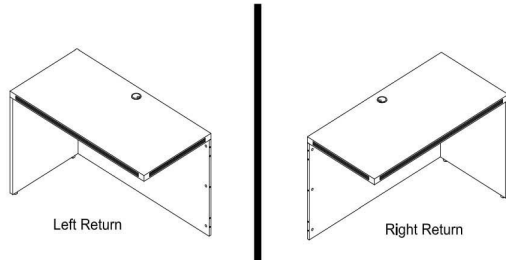





Customer Service available 8:30 - 5:00 Central Time, Monday - Friday

Reversible Desk Return Assembly Instructions



Applies to:
BK/CH/FL/MJ/ML/WH2045

List of Hardware:

Part	Part	Part
 Wood Dowel	 Shallow Cover	 Worksurface Bracket
 Cam Pin	 Deep Cover	 Side Panel Brackets (2)
 Cam Lock	 Grommet	 M6 Screw
 Wood Screw		 Leveling Glide

Tools Needed:

- Phillips Screwdriver
- Power Screwdriver
- A Helper

- 1.) Assemble on carpet or cardboard to protect parts during assembly. Assembly will require 2 people for safety.
- 2.) Determine if the return will be left or right handed (see diagram next page). Locate Side Panel & End Panel and arrange like shown in drawing. Insert leveling glides, then insert all cam pins, cam locks and wood dowels. Then connect the panels by inserting the dowels into the holes on opposite panel and inserting cam pins into cam locks (see diagram). Then, twist the cam locks with a Phillips Screwdriver to secure connection.
- 3.) Next, locate the Desktop and insert hardware. Then, set the desktop on the lower assembly and twist cams to securely connect.

Special Note:

Location & number of cam pin, cam lock and dowel holes may vary.

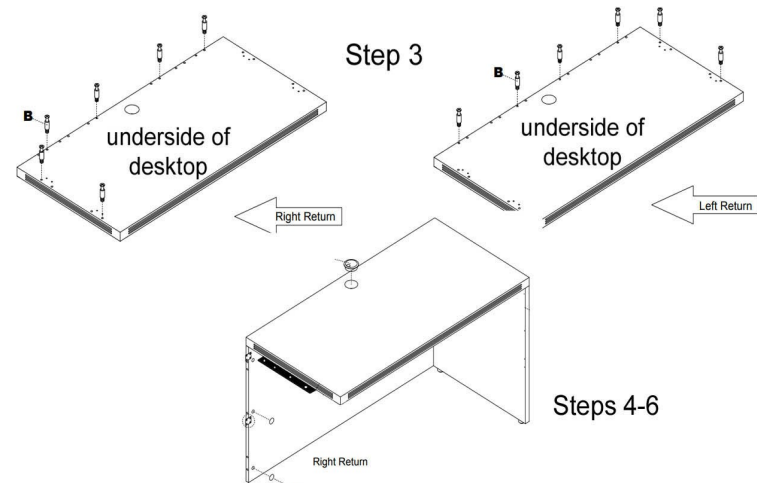
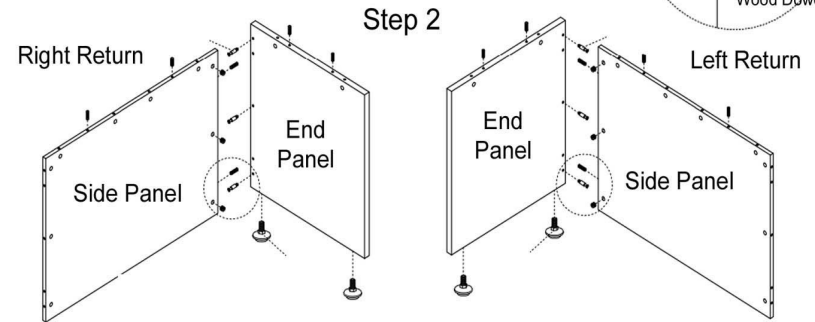
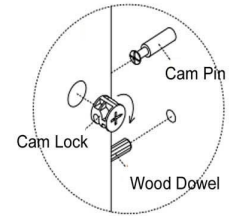

- 4.) Now it's time to attach the return to your desk. Locate the large flat bracket and M6 machine screws (it may be attached to the desktop already. If not, center the bracket over the edge and install 4 of the screws). With a helper, have one person hold the return desk stable while the other screws the machine screws into the desk.
- 5.) Once installed & leveled, use the wood screws to install the offset side panel brackets. This will further secure the side panel, but is an optional step. A power screwdriver is helpful.
- 6.) Lastly, insert the grommet into the desktop and use the caps provided to cover the cam locks.

Questions? Please call 1-800-443-5117.



Customer Service available 8:30 - 5:00 Central Time, Monday - Friday

Box/Box/File Desk Pedestal Assembly Instructions

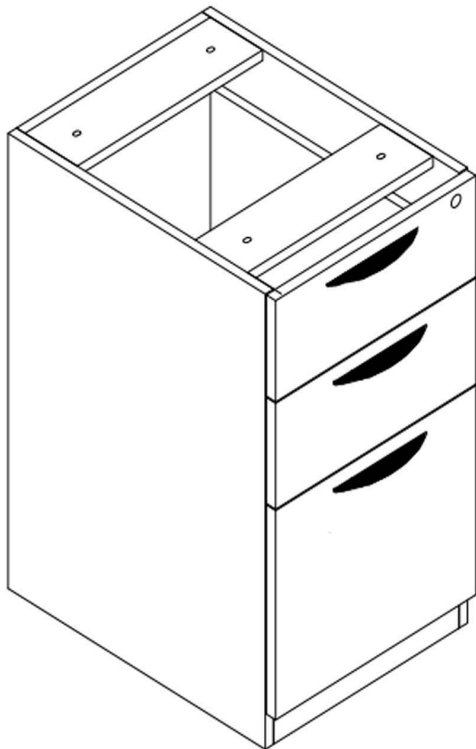
Applies towards:
BK/CH/FL/MJ/ML/WH2066

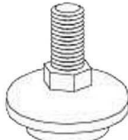

List of Hardware:

Part	Part
 4 Large Bolts	 3 Drawer Pulls with screws
 1 set of keys	 4 Leveling Glides

- 1.) Install 4 leveling glides.
- 2.) Use the screws to attach drawer pulls.
- 3.) To install under desk, remove the top box drawer (or top two box drawers) by locating the black tabs inside of the left & right drawer slides. Push down on one and push up on the other. This will release the drawer from the slides. Use 4 large bolts to connect to threaded holes on underside of desk. Once done, simply insert drawers back into the slides. They will snap in place.

4-Door Hutch Assembly Instructions

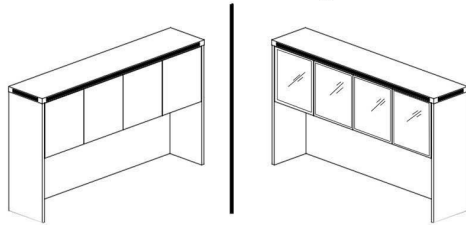









Applies to:
BK/CH/FL/MJ/ML/WH2044
MJ2025-CHL

Questions? Please call 1-800-443-5117.

Customer Service available 8:30 - 5:00 Central Time, Monday - Friday

List of Hardware:

Part	Part	Part
		Qty 4 
		Qty 4 
		Qty 8 

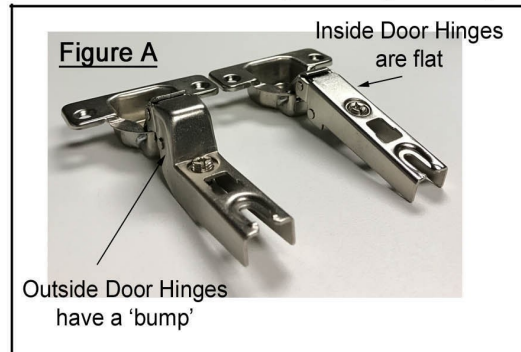

1.) Locate the Back Panel, Left & Right Side Panels and Center Shelf. Insert all wooden dowels, cam pins and cam locks. Connect Back Panel to the Center Shelf. Then connect the Left Side Panel, then Right Side Panel. Once all panels are connected, use your screwdriver to twist the cam locks to secure the connections.

2.) Connect the Middle Support Panel in same method.

3.) Attach Top Surface in same method.

4.) Attach all 8 Hinge Plates to the inside walls of the hutch. Use two per door. The holes are piloted. **DO NOT TIGHTEN DOWN THE SCREWS ALL OF THE WAY. LEAVE WIGGLE ROOM!**

Tools Needed:

-Phillips Screwdriver
-A Helper

Special Note:

Location & number of cam pin, cam lock and dowel holes may vary.

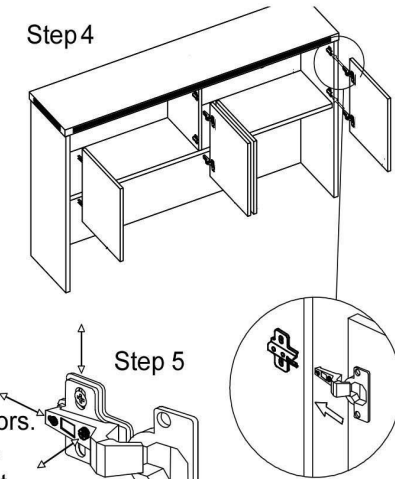
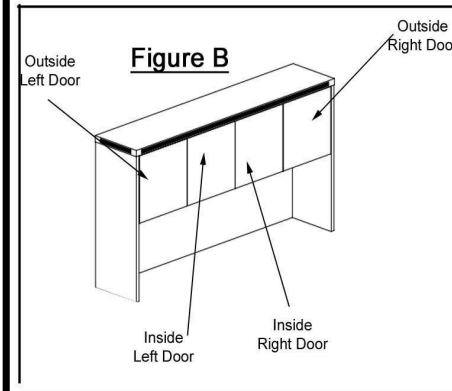
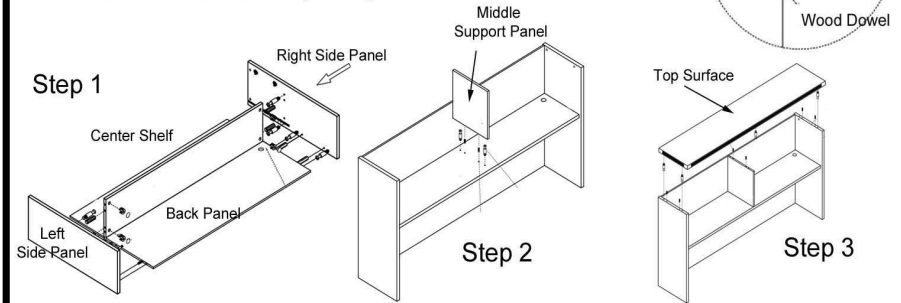

4.) Your next step is to attach the hutch doors. See Figure "B" which identifies the Outside Doors and Inside Doors. There are different hinges that connect the inside & outside hinges. See Figure "A" to help identify. Attach two hinges per door. Use the hinges with the 'bump' on the Outside Left & Right Doors and the flat hinges on the Inside Left & Right Doors. The holes are piloted. Use the screws provided. Once the hinges are attached, slide the hinges over the Hinge Brackets, fitting the screw head of the Hinge Bracket in the slot of the Hinge. Once fitted, slightly tighten the set screw. Now, set your hutch on your desk. Use the double-sided tape to securely adhere to desktop.

5.) Next, it is time to adjust the doors so that they properly align. Using your screwdriver, turn the Set Screw on the hinge to adjust the depth and the screws on the hinge plate to move the door up/down.

6.) Last step is to install Cam Lock Caps and Grommet cover.

Video on Hinge Door Adjustment available at link:
<http://www.modernofficefurniture.com/office-furniture-assembly-instructions.html>

"How to Adjust Hinges on 4-Door Hutch"