

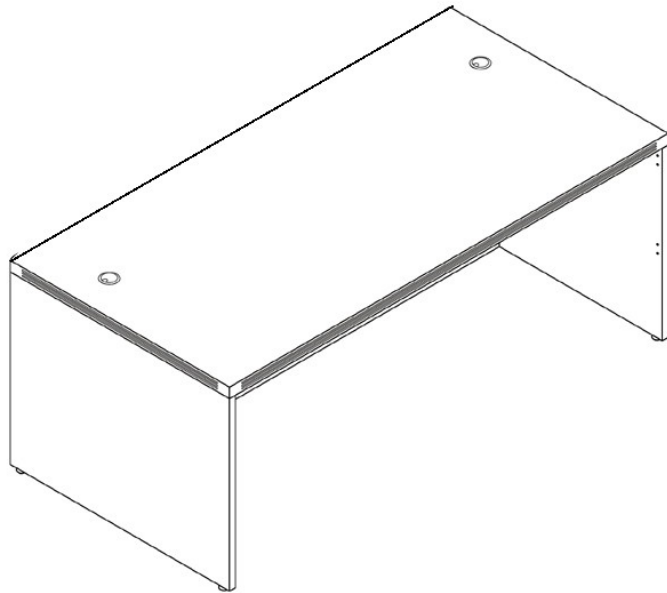

Modern Office  
6900 Shady Oak Road, Ste 120  
Eden Prairie, MN 55344  
Phone: 800.443.5117  
(In MN): 952.941.2837  
Fax: 952.949.9816  
www.modernofficefurniture.com



## Desk/Credenza Shell

MJ/FL/ML/WH  
2001/2002/2043/2089/3624/7124

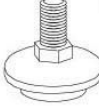

## ASSEMBLY INSTRUCTIONS

## PARTS LIST

Part	Part
 Wood Dowel	 Cap
 Cam Pin	 Leveling Glide
 Cam Lock	 Grommet
 Screw	 L-Bracket



Modern Office  
6900 Shady Oak Road, Ste 120  
Eden Prairie, MN 55344  
Phone: 800.443.5117  
(In MN): 952.941.2837  
Fax: 952.949.9816  
www.modernofficefurniture.com

1.) Assemble on a smooth, carpeted floor to prevent scratches or damage. Assembly will require 2 people for safety.

2.) Screw 2 leveling glides in completely on both side panels. When completed, the glides can be adjusted outward to level the desk on uneven floors.

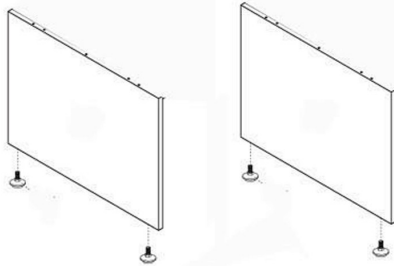

3.) Next, take out the front panel and position with side panels like shown on page 3.

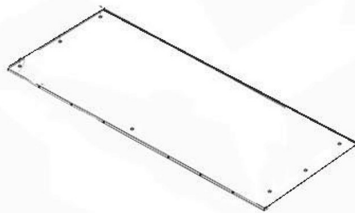

**2**

4.) Insert wood dowels into large holes and cam pins into smaller holes. Align the panels together and attach using a Phillips Screwdriver to twist the cam locks to secure.

(Number of holes in diagram may vary from actual desk)

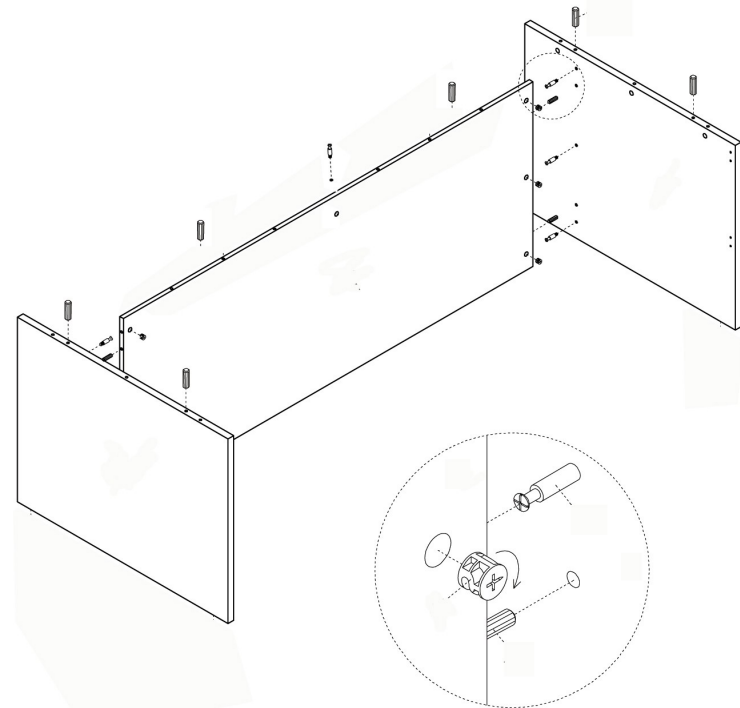

**3**



Modern Office  
6900 Shady Oak Road, Ste 120  
Eden Prairie, MN 55344  
Phone: 800.443.5117  
(In MN): 952-941-2837  
Fax: 952.949.9816  
www.modernofficefurniture.com

- 5.) Lower Desktop onto front and side panels, making sure to align holes. Twist any remaining cam locks to secure.
- 6.) L-brackets and screws are optional and can be placed anywhere underneath the desktop for additional strength. Screws are self-drilling
- 7.) Install grommets. Note: Credenza Shells have only 1 grommet.
- 8.) Lastly, pop in any cam lock covers over the silver cam locks.

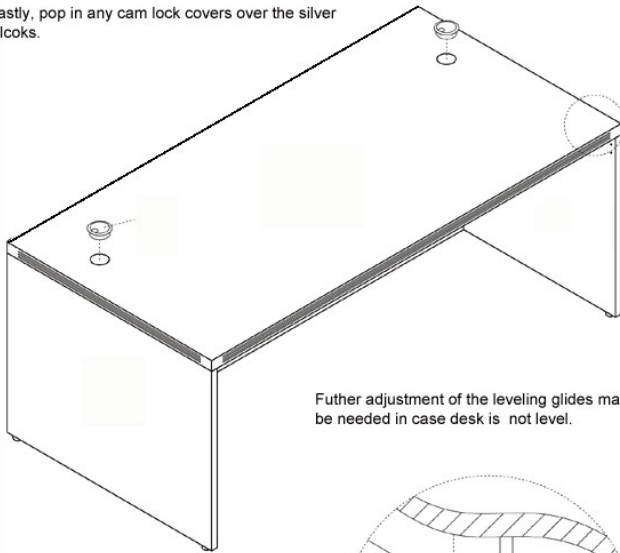

Further adjustment of the leveling glides may be needed in case desk is not level.

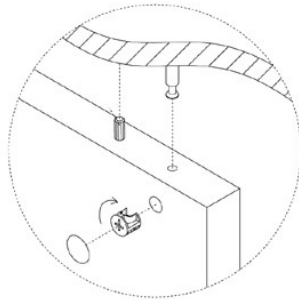



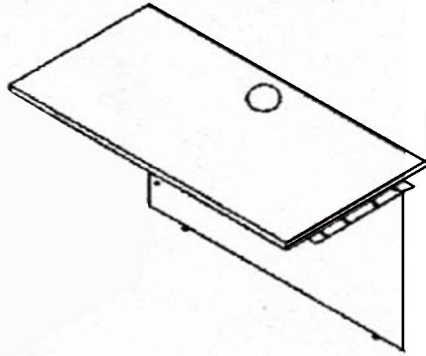







## Reversible Bridge for U-Desk MJ/FL/ML/WH2070

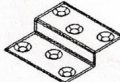

# ASSEMBLY INSTRUCTIONS

## PARTS LIST

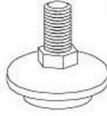
Part	Part	Part
 Wood Dowel	 Shallow Cover	 Worksurface Bracket
 Cam Pin		 Side Panel Brackets (2)
 Cam Lock	 Grommet	 M6 Screw
 Wood Screw	 L-Bracket	 Leveling Glide

## Can be used in left or right configuration

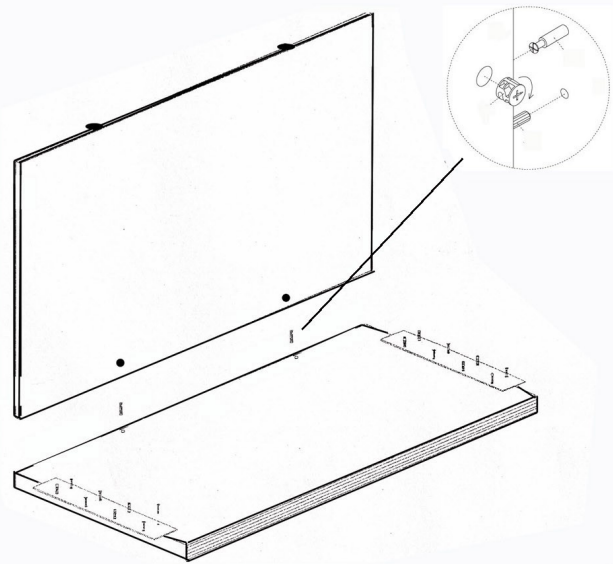
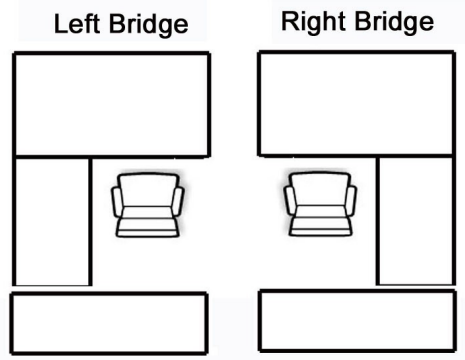



- 1.) Assemble with desktop face down on carpet or cardboard for protection during assembly.
- 2.) Attach long, worksurface brackets to underside of bridge. Use round-head screws to attach. Insert all/any hardware on worksurface.
- 3.) Insert any cam locks, cam pins and dowels to the side panel. Connect side panel to top panel using cam locks and pins. Use a Phillips screwdriver to twist the cam locks to secure.
- 4.) Screw in leveling glides on side panel.
- 5.) Carefully turn unit upright. Place in U-desk where you wish to connect. Level the desk if needed. Connect the worksurface brackets on the bridge to the front desk and back desk using same round-head screws.
- 6.) Using pointed wood screws and bent side panel brackets, connect the bridge side panel to the side panels of the front desk and back desk. Center bracket over the seam.
- 7.) Insert the shallow covers over the cam locks. Insert grommet in desktop.

## 2-Drawer/4-Drawer Lateral File

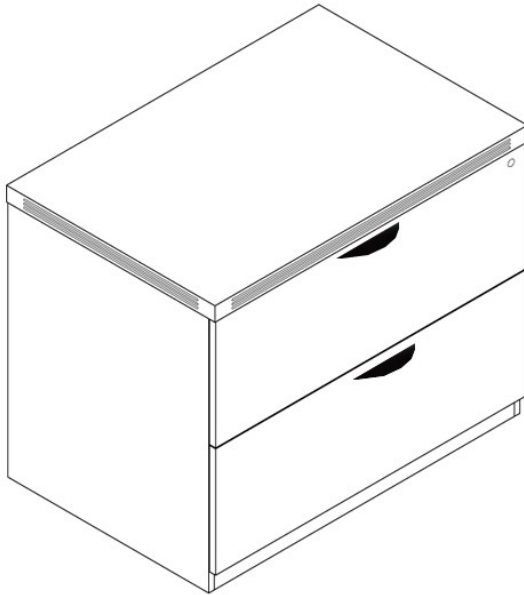
MJ/FL/ML/WH2012  
MJ/FL/ML/WH2012A

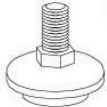

## PARTS LIST

Part	Part
 Screw	 Drawer Pull
 Keys	 Leveling Glide

- 1) Install 4 leveling glides and level the file
- 2.) Install drawer pulls with screws provided.

## 4-Door Hutch Assembly Instructions

MJ2025 - 48"W Hutch and MJ/FL/ML/WH2044 - 71" Hutch

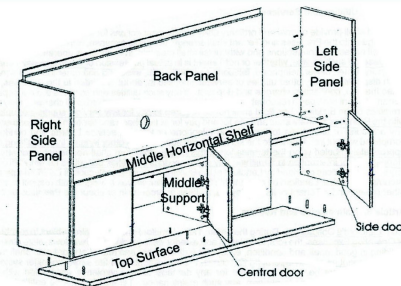

- 1.) Hutch should be assembled upside down until the final step of attaching doors.
- 2.) Insert all cam pins and dowels into hutch top and side panels in preparation of assembly. Identify 8 sets of holes approximately 2" from front edge of panels. Do not insert cam pins in these holes as they will be left open for door hinge brackets. Insert all circular camlocks into camlock holes, with the arrow on face of camlock pointing towards the closest edge of the piece where it will attach to the cam pin.
- 3.) Assemble pieces in following order – do not tighten camlocks until all the pieces are in position. It may be necessary to have a helper hold pieces in place while assembling, or partially tightening some of the connections.
  - A – Attach *Left Side Panel* to *Top Surface*
  - B – Attach *Middle Support* to *Top Surface*
  - C – Attach *Middle Horizontal Shelf* to *Left Side Panel* and *Middle Support*
  - D – Attach *Back Panel* to *Left Side Panel* and *Top Surface*. Make sure all camlocks face the rear of the unit so they are not exposed on front of unit.
  - E – Attach *Right Side Panel* to *Top Surface*, *Horizontal Center Shelf* and *Back Panel*. Do so by making connections to top surface first and then tipping side panel pins/dowels into *Horizontal Center Shelf*.
- 4.) Now tighten all connections until firmly in position.
- 5.) Turn unit over and attach to credenza or desk by peeling two-sided tape from underside and placing firmly in position where it will be used. HINT: It is easier to put the unit in place without the doors because the unit may shift while moving, causing the doors to get out of alignment and have to be readjusted.
- 6.) Attach and only partially tighten the 8 "+" shaped hinge brackets to the interior panels of the hutch with the screws provided. Do not tighten these hinge pieces. Leave them loose so that when the hinges are attached there is some play in them so they can align more easily with the door hinges. This will also allow you to raise and lower the doors so they align evenly with the hutch top panel.

## Hinges

7.) Attach hinges to doors. **IMPORTANT:** Set all eight hinges next to each other before attaching. Notice that there are 'short depth' hinges and 'long depth' hinges. Attach the long depth hinges to the outside doors and the short hinges to the two middle doors.

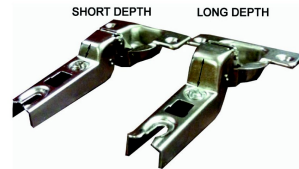

8.) Now tighten interior "+" hinge brackets at desired height so doors are at the same height. Adjust hinge screws to align doors. You will notice that adjusting the fore and aft screws of the hinge adjusts the angle of the doors as needed.

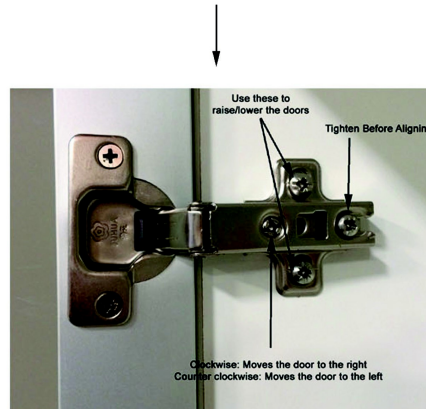









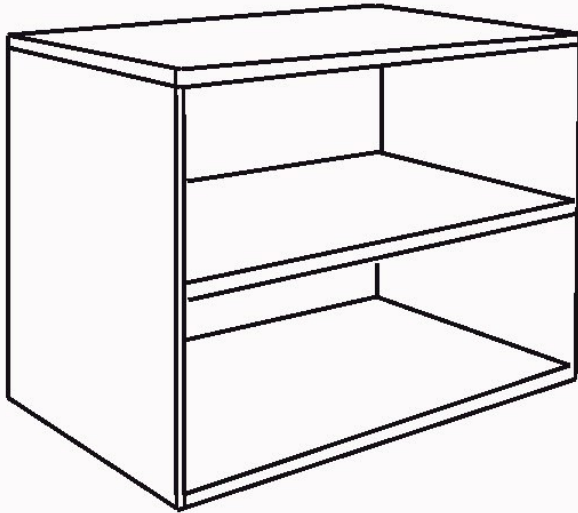

Modern Office  
6900 Shady Oak Road, Ste 120  
Eden Prairie, MN 55344  
Phone: 800.443.5117  
(In MN): 952.941.2837  
Fax: 952.949.9816  
[www.modernofficefurniture.com](http://www.modernofficefurniture.com)

## WHITE 2-SHELF BOOKCASE



WH2050

## PARTS LIST

Part	Part
 Wood Dowel	 Shallow Cover
 Cam Pin	 Deep Cover
 Cam Lock	 Deep Cover



Modern Office  
6900 Shady Oak Road, Ste 120  
Eden Prairie, MN 55344  
Phone: 800.443.5117  
(In MN): 952-941-2837  
Fax: 952.949.9816  
www.modernofficefurniture.com

Assemble on a smooth, clean surface to prevent scratches.

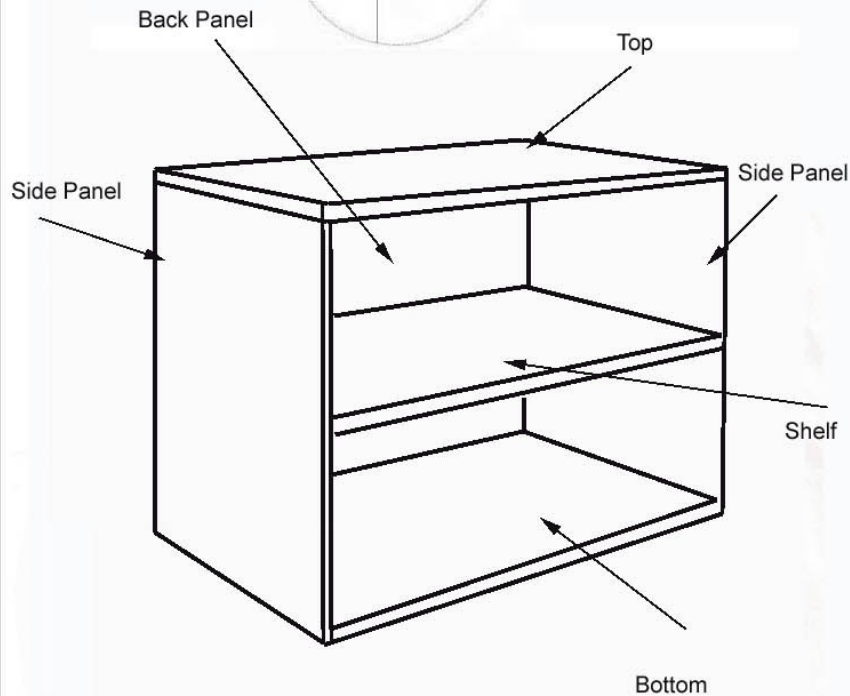
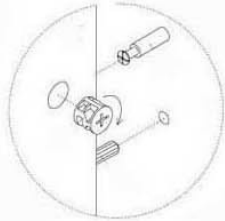

Modern Office  
6900 Shady Oak Road, Ste 120  
Eden Prairie, MN 55344  
Phone: 800.443.5117  
(In MN): 952-941-2837  
Fax: 952.949.9816  
www.modernofficefurniture.com

- 1.) Screw in all camlock pins and insert all wooden dowels in both SIDE PANELS, BACK PANEL, TOP and BOTTOM.
- 2.) Assemble the bookcase on its side. Begin by attaching the BOTTOM and one SIDE PANEL by placing it over the cam pins and inserting the cam locks. DO NOT YET TIGHTEN.
- 3.) Assemble the bookcase on its side. Begin by attaching the base with the trim piece by placing it over the cam pins and inserting the cam locks. DO NOT YET TIGHTEN.
- 4.) Connect BACK PANEL using same hardware method.
- 5.) Connect TOP and other SIDE PANEL. When done, TIGHTEN ALL CAM LOCKS.
- 6.) Turn unit right side up and place in area of intended use. Insert shelf pins and SHELF where desired.
- 7.) Cover the cam locks with the caps provided.



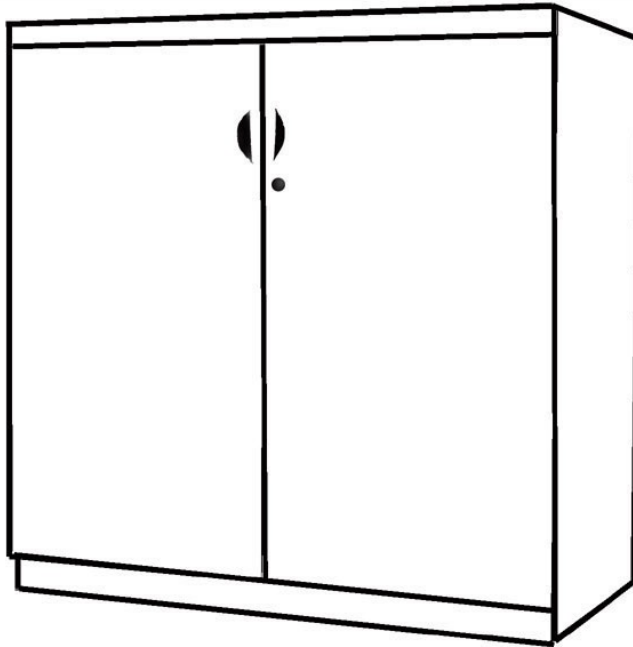





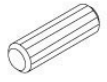

## 2-Door Cabinet Assembly Instructions



Applies towards

MJ/FL/ML/WH2013/2052

## PARTS LIST

Part	Part
<p>A</p>  <p>Wood Dowel</p>	 <p>Shelf Pin</p>
<p>B</p>  <p>Cam Post</p>	 <p>Plunger Lock</p>
<p>C</p>  <p>Cam Fastener</p>	 <p>Leveling Glide</p>
 <p>Drawer Pull &amp; Screws</p>	 <p>Shallow Cover</p>
 <p>Lock &amp; Key Set</p>	 <p>Deep Cover</p>

You should also have  
4 hinges, with screws  
included.



Screws for hinges  
are located inside  
the hinges

1.) First step, lay all of the panels out and attach/insert the hardware. Cam Posts (or Cam Pins) fit in the smallest holes. Wooden dowels fit in the larger holes. Cam Fasteners (or Cam Locks) fit in the holes adjacent to the Cam Posts. Attach 4 leveling glides to the Left & Right panels. Also attach the hinge plates to the Left & Right side panels, as attaching the hinges to the doors. The holes for the hinge plates will be piloted toward of front of the left & right side panels. Leave screws somewhat loose for ease of adjustment later on. Lastly, attach the door pulls to the doors using the screws provided. Save attaching the locks for the last step.

Y10407/WH2013 White 2-Door Cabinet will not have a kickplate

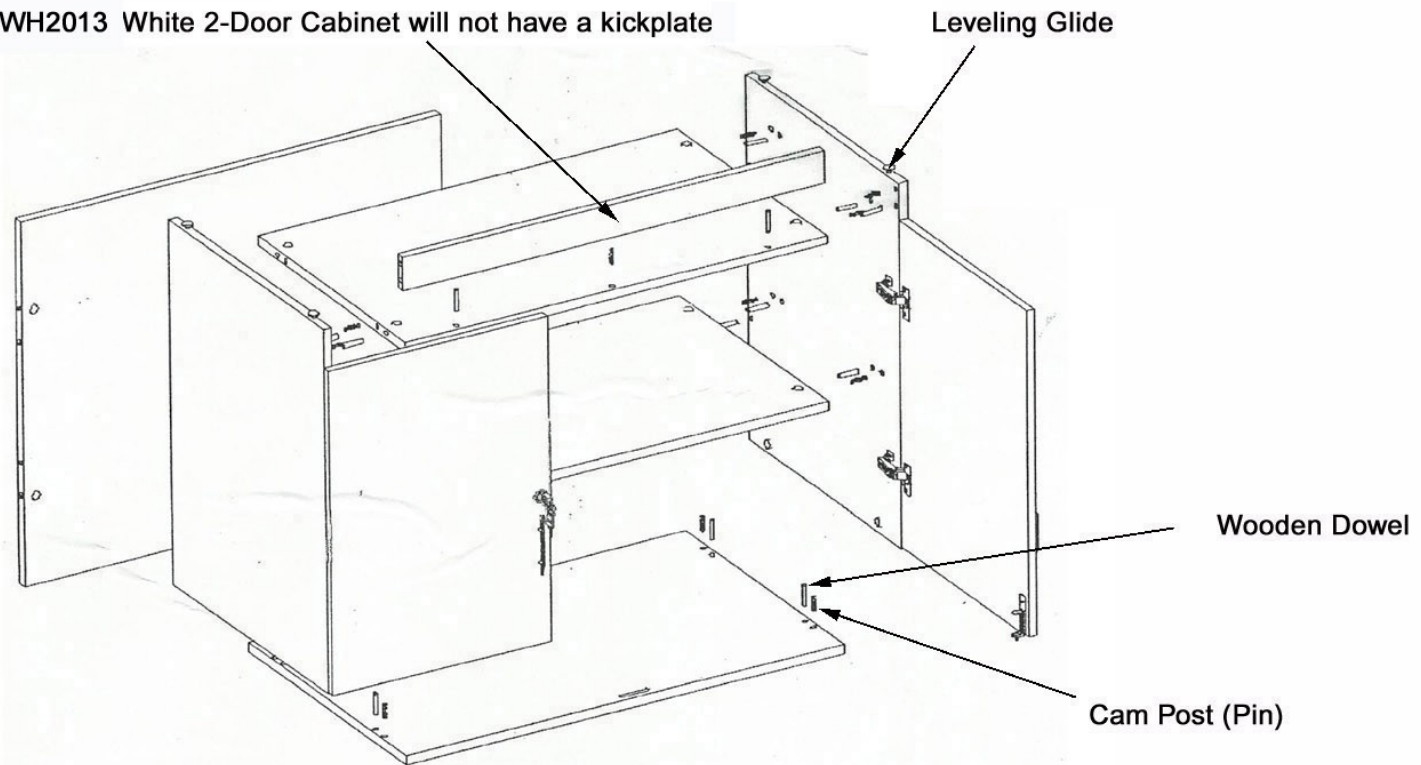

**Other Tips:**

-A second person may be handy to help hold some of the panels in place during assembly and to help turn the unit over once assembled.

-Assemble in a carpeted area near where the unit will be used.

-You will need a Phillips Screwdriver to assemble this product.

- 2.) Assemble unit by laying the back panel, finished side down on the floor. Then, attach the right side panel (2) using the cam posts, fasteners and dowels provided.
- 3.) Next, attach Bottom Panel, Center Shelf and Kickplate using same hardware provided.  
(Skip kickplate step if assembling Y10407)
- 4.) Now, attach Left Side Panel using same hardware.
- 5.) Attach the Top Surface using same hardware. The shell of the unit should now be complete. Carefully turn the unit upright.
- 6.) Mount the shelf using the Shelf Pins included.
- 7.) Your next step is to attach the doors using the hinges. Attach the hinges to the doors if you have not done so already. You will need to align the doors by turning the set screw with your Phillips screwdriver. See diagram below.
- 8.) Your last step is to attach the lock. Attach the lock core with the wood screws provided. Attach the Plunger Lock on doors as shown, again using wood screws provided. The plunger should align with the routed out hole in the underside of the Top Surface.

*To lock doors: Close door with plunger lock and push in Plunger. Close the other door and turn the key.*

*To unlock: Turn the key to unlock first door, then hit the red button on the Plunger Lock to release the plunger.*

### Order of Panel Assembly:

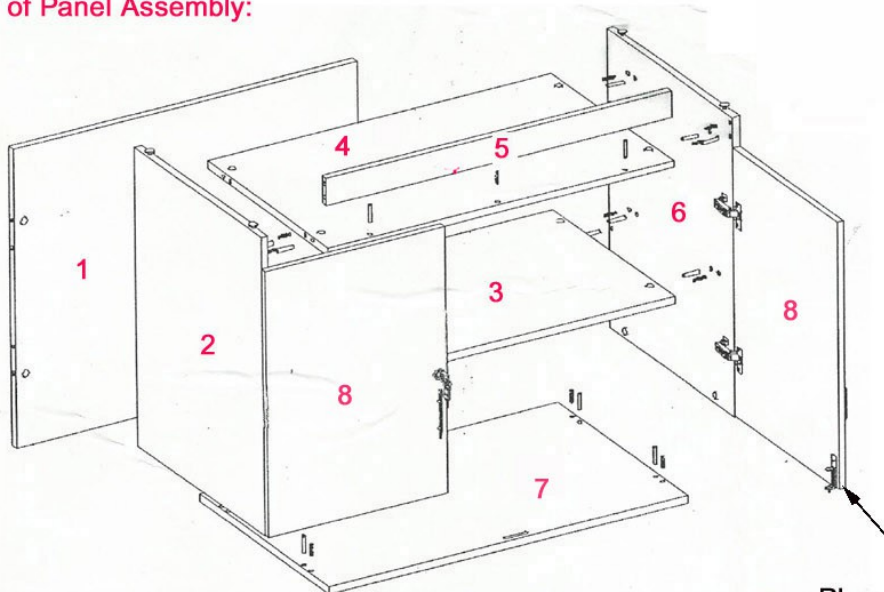

Plunger Lock

