

Desk/Credenza Shell Assembly Instructions

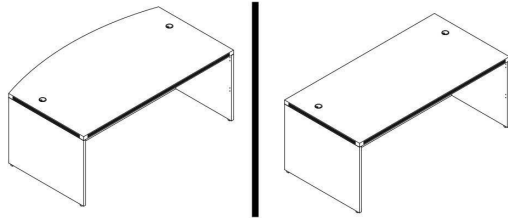

Applies to:

(BK/CH/MJ/ML/MWAL/WH) 2001/2002/2043/2089/3624/7124

List of Hardware:

Part	Part
 Wood Dowel	 Cap
 Cam Pin	 Leveling Glide
 Cam Lock	 Grommet

Tools Needed:

- Phillips Screwdriver
- A helper!

- 1.) Assemble on carpet or cardboard to protect parts during assembly. Assembly will require 2 people for safety.
- 2.) Locate left & right side panels. Screw in the leveling glides by hand. Then, insert wood dowels & cam pins. The wood dowels fit into the slightly larger holes, compared to the cam pin holes
- 3.) Locate front panel and insert all cam locks on the left & right sides. Then, align one of the side panels and connect the panel by inserting the cam pins into the cam locks and the dowels into the corresponding holes. (see diagram on next page). Twist the cam locks with a Phillips Screwdriver to secure.

Special Note:

Location & number of cam pin, cam lock and dowel holes may vary.

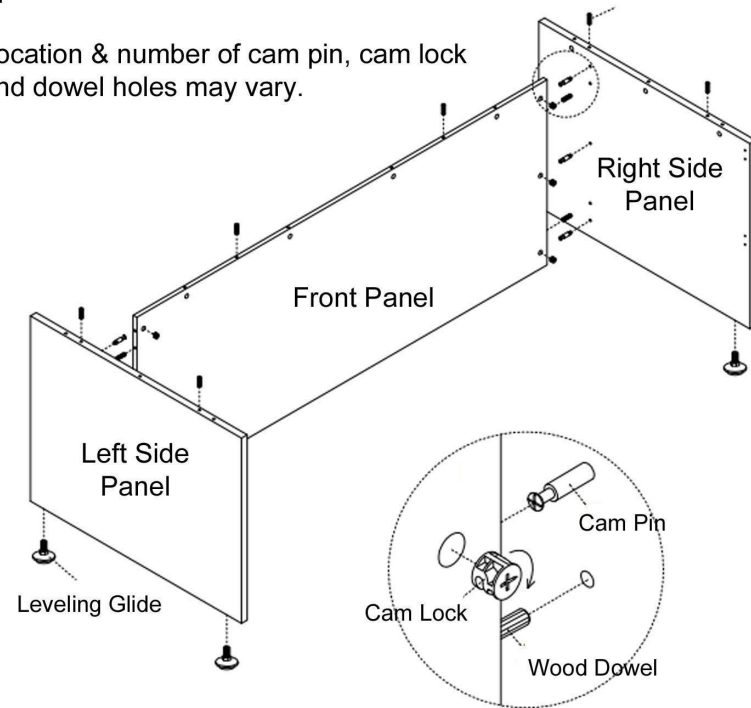

- 4.) Next, insert all cam pins, dowels and cam locks on the top edges of the side panels and front panels. Locate the desktop and with a helper, carefully set the desktop on top of the assembly shown above. Twist cam locks to secure the connection.

- 5.) Your last step is to insert the grommet(s) provided into the desktop. Cover the cam locks with the caps provided.

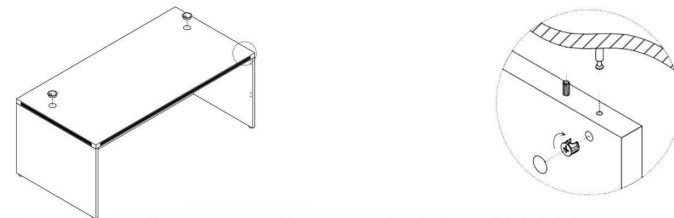

Questions? Please call 1-800-443-5117.

Customer Service available 8:30 - 5:00 Central Time, Monday - Friday



2, 3 & 4 Drawer Lateral File Assembly Instructions

Applies towards:

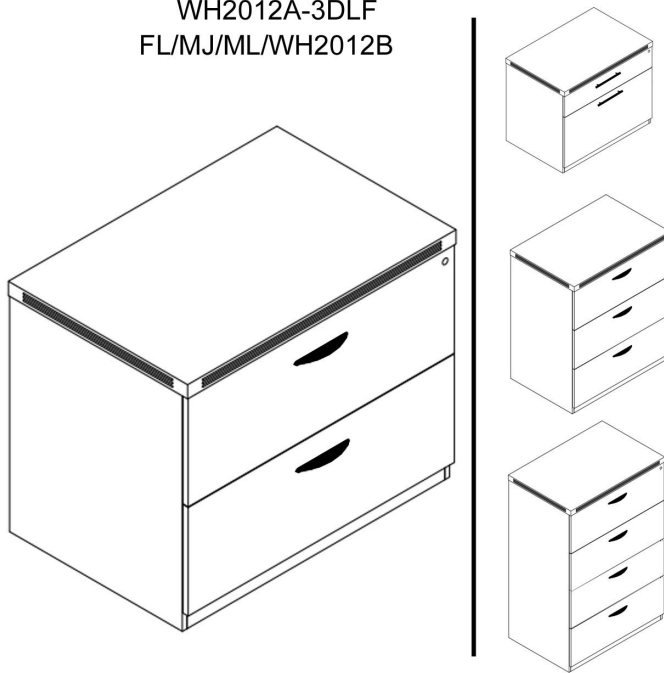
BK/FL/MJ/ML/WH2012
 WH2012A
 LF3622-MWAL
 LF3622-WH
 WH2012A-3DLF
 FL/MJ/ML/WH2012B

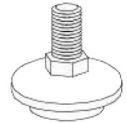

List of Hardware:

Part	Part
 Drawer Pull Screw 2 per drawer pull	 Drawer Pull 1 per drawer
 1 set of keys	 4 Leveling Glides

- 1.) Install 4 leveling glides. Keep the front two leveling glides 1/4" taller than the back back two, which means your file will be slightly tilted back. This is the proper way to level a lateral file cabinet. It keeps any unlocked file drawers from creeping open and distributes the weight more evenly.
- 2.) Use the screws to attach drawer pulls.

Questions? Please call 1-800-443-5117.
 Customer Service available 8:30 - 5:00 Central Time, Monday - Friday

2-Door Cabinet Assembly Instructions

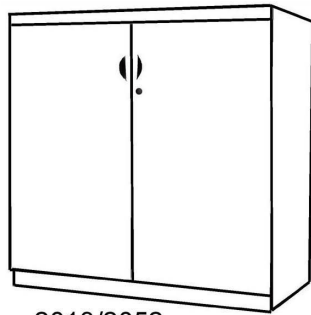

2013/2052

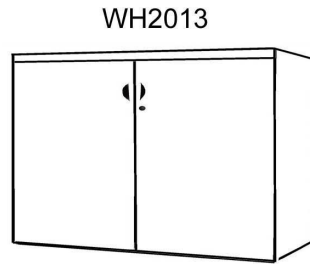

WH2013

Applies Towards:

FL/ML/MJ/WH2013











WH2013A

FL/ML/MJ2052

Tools Needed:

- Phillips Screwdriver
- A Helper

List of Hardware:

 Wood Dowel	 Shelf Pin	 Hinge
 Cam Pin	 Plunger Lock	 Hinge Plate
 Cam Lock	 Leveling Glide	 Lock/Key
 Door Pull	 Shallow Cover	 Deep Cover

Step 1.) For 2013 and 2052 cabinets only. Attach Toe Kick to Bottom Panel with cam pins & locks. Assemble upside down.

Step 2.) (For all cabinets) Attach Back Panel to Bottom Panel with cam pins & locks.

Step 3.) Attach Left & Right Side Panels in same manner.

Step 4.) Attach Top Surface with cam locks, cam pins and dowels. Then, insert the four leveling glides.

Step 5.) Insert shelf pins into holes along the interior sides. Place Shelf on top of the pins.

Step 6.) Attach four hinge plates with the screws included. The holes are piloted. DO NOT TIGHTEN ALL OF THE WAY! LEAVE WIGGLE ROOM FOR ADJUSTMENT LATER ON.

Special Note:

Location & number of cam pin, cam lock and dowel holes may vary.

Step 1



Step 3

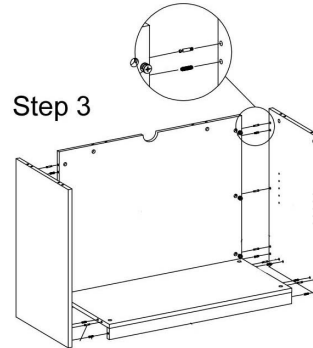

Step 5

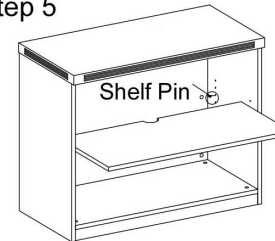

Hinge Adjustment

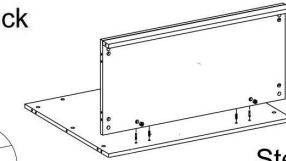

Step 2

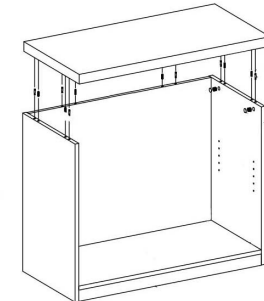

Step 4

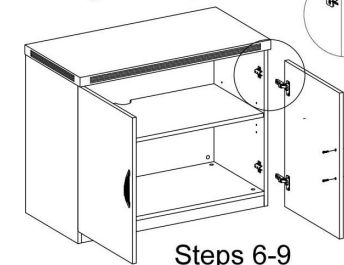

Steps 6-9

Step 7.) Attach two hinges per door. The holes are piloted. Then, insert the hinges into the hinge plates inside the cabinet. Connect with screws.

Step 8.) Attach the door pulls with the screws included. Insert shallow & deep covers over cam lock holes. Deep covers are for interior cams, shallow are for the back panel cams.

Step 9.) Once you have the cabinet in the place you intend to use it, it will be time to adjust the hinges to align the doors. Using your screwdriver, turn the set screw on the hinge to adjust the depth and the screws on the hinge plate to move the door up/down. See diagram above.

Step 10.) Your last step is to insert the shallow & deep covers over the cam locks and to attach the plunger lock and lock core. Locate the pre-drilled notch on the underside of the Top Surface. Attach plunger lock so it inserts into the notch when pushed in. Attach the lock core with four screws provided.

Questions? Please call 1-800-443-5117.

Customer Service available 8:30 - 5:00 Central Time, Monday - Friday