

Desk/Credenza Shell Assembly Instructions

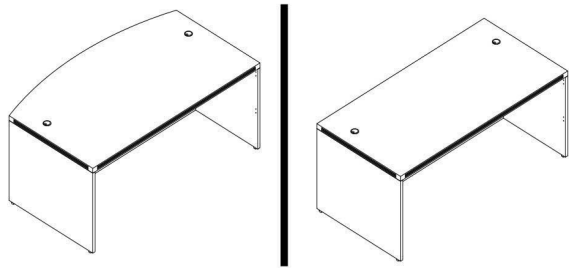

Applies to:

(BK/CH/MJ/ML/MWAL/WH) 2001/2002/2043/2089/3624/7124

List of Hardware:

Part	Part
 Wood Dowel	 Cap
 Cam Pin	 Leveling Glide
 Cam Lock	 Grommet

Tools Needed:

- Phillips Screwdriver
- A helper!

1.) Assemble on carpet or cardboard to protect parts during assembly. Assembly will require 2 people for safety.

2.) Locate left & right side panels. Screw in the leveling glides by hand. Then, insert wood dowels & cam pins. The wood dowels fit into the slightly larger holes, compared to the cam pin holes

3.) Locate front panel and insert all cam locks on the left & right sides. Then, align one of the side panels and connect the panel by inserting the cam pins into the cam locks and the dowels into the corresponding holes. (see diagram on next page). Twist the cam locks with a Phillips Screwdriver to secure.

Special Note:

Location & number of cam pin, cam lock and dowel holes may vary.

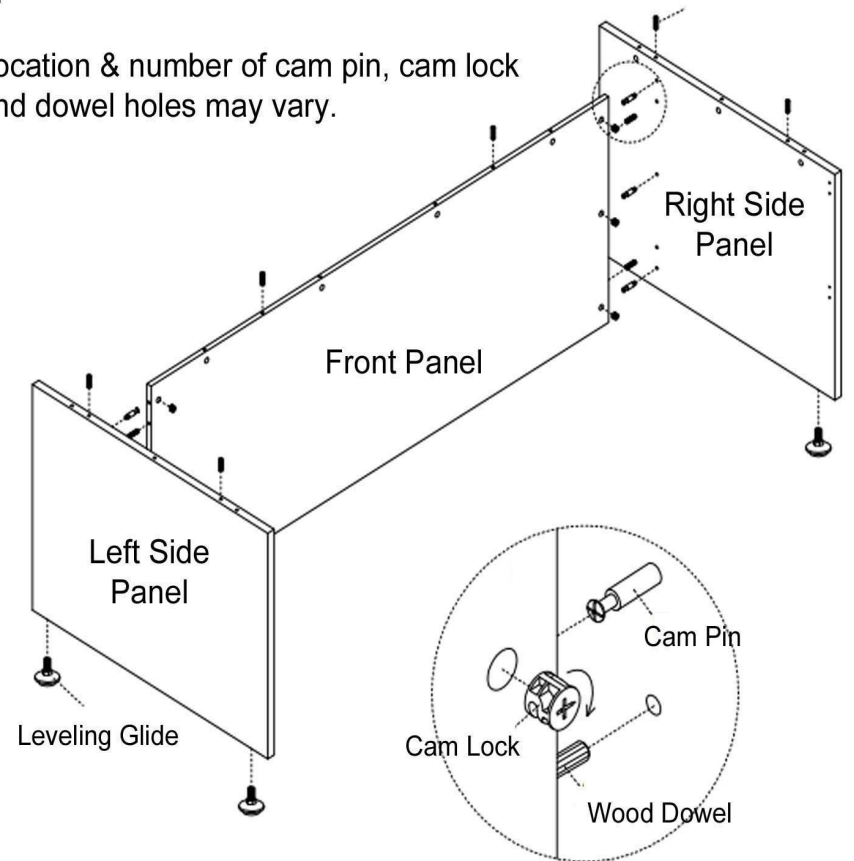

4.) Next, insert all cam pins, dowels and cam locks on the top edges of the side panels and front panels. Locate the desktop and with a helper, carefully set the desktop on top of the assembly shown above. Twist cam locks to secure the connection.

5.) Your last step is to insert the grommet(s) provided into the desktop. Cover the cam locks with the caps provided.

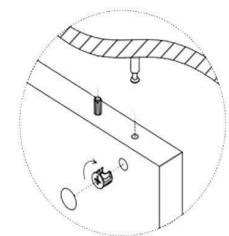
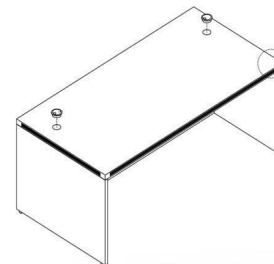

Questions? Please call 1-800-443-5117.

Customer Service available 8:30 - 5:00 Central Time, Monday - Friday



www.modernofficefurniture.com

Y11927, Y11928, Y11929,
Y11930 and Y11931 Reception
Desks with Reception Cap









White Reception Cap Assembly Instructions
CAP66 & CAP72



Tools Required:

- Phillips Screwdriver
- or
- Power Screwdriver (set on lightest setting to avoid stripping of screws)

Hardware Included:

<p>Cam Lock</p>  <p>A</p> <p>QTY 32</p>	<p>Cam Pin</p>  <p>B</p> <p>QTY 32</p>	<p>Wood Dowel</p>  <p>C</p> <p>QTY 8</p>	<p>Spacer Cylinder for Rec. Cap</p>  <p>D</p> <p>QTY 4</p>
<p>1" Threaded Support for Glass Counter</p>  <p>E</p> <p>QTY 8</p>	<p>Threaded Cylinder Bolt</p>  <p>F</p> <p>QTY 8</p>	<p>Threaded Cylinder Cap</p>  <p>G</p> <p>QTY 8</p>	<p>Light Fixture Kit</p> 

Questions? Please call 1-800-443-5117.

Customer Service available 8:30 - 5:00 Central Time, Monday - Friday

Step 1) Uncarton and lay out components on a smooth carpeted surface to protect from scratching.

Step 2) Screw in 6 (B) Cam Pins into 3/4" thick Riser Shelf.

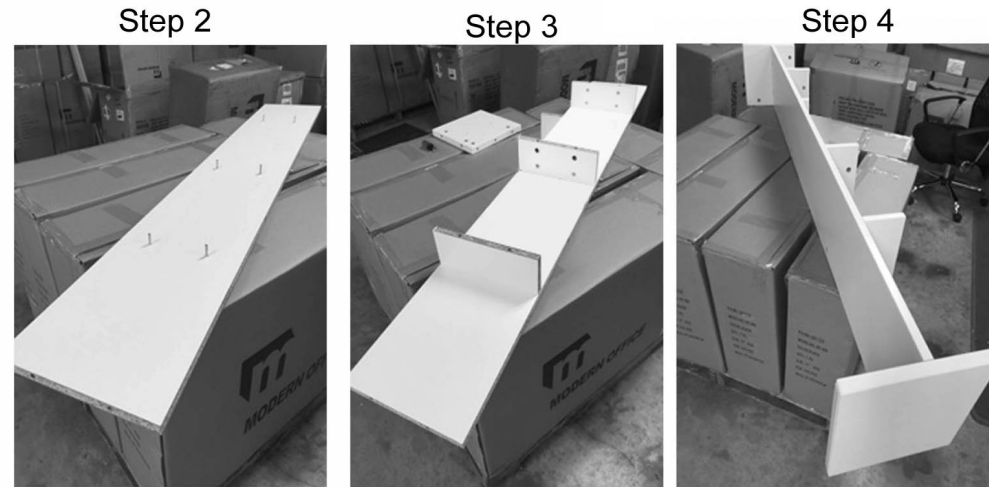

Step 3) Attach 3 Shelf Dividers using two (A) Cam Locks each.

Step 4) Attach Left and Right Sides using two (A) Cam Locks each.
Set aside until Step 7.

Step 5) Prepare Front Panel by first attaching six (B) Cam Pins. Larger holes next to cam pin holes will be used for (C) Wood Dowels to add extra support. Next, screw in 4 (D) Spacer Cylinders with threaded ends into metal inserts in Front Panel. These will serve as spacers between the front side panels of the desk and the Front Panel of the reception desk allowing the electrical cable of the light to run over desk top and back down into desk through desk top cable grommet.



Step 6) Prepare and attach light fixture. Plug cord into end of light fixture. Attach two clips/brackets to Front Panel with two wood screws provided into predrilled holes of Front Panel. Light fixture will then clip onto brackets.

Step 6



Step 7



Step 7) Mount frame assembled in steps 2-4 onto Front Panel using six (A) Cam Locks. Now mount 1" thick Riser Top using eight (A) Cam Locks.

Step 8) Main reception cap is now complete and ready to mount to desk before final step of attaching glass. Peel 2-sided tape from underside of Left and Right Sides and carefully position on desktop. Light cable should be routed up and over desktop before adhering reception cap so that cable is not exposed from visitor's side of desk. Cable will then route through desk top cable grommets and down to floor under desk.

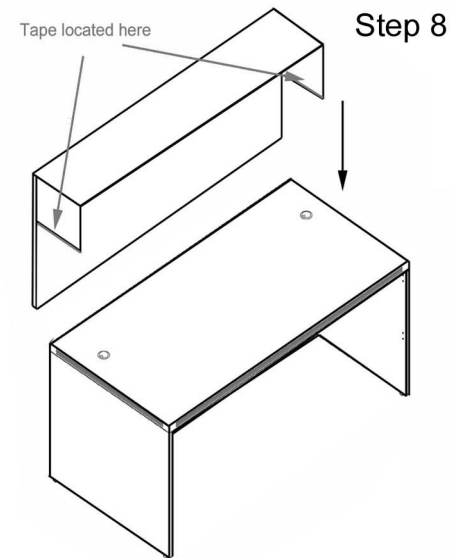

Step 9) Once reception cap is positioned and adhered, attach Glass Counter using eight (G) Threaded Small Top Cylinder Caps, eight (E) 1" Support Cylinders and eight (F) Threaded Cylinder Bolts. These can be tightened down by hand.



Peninsula Desk Assembly Instructions

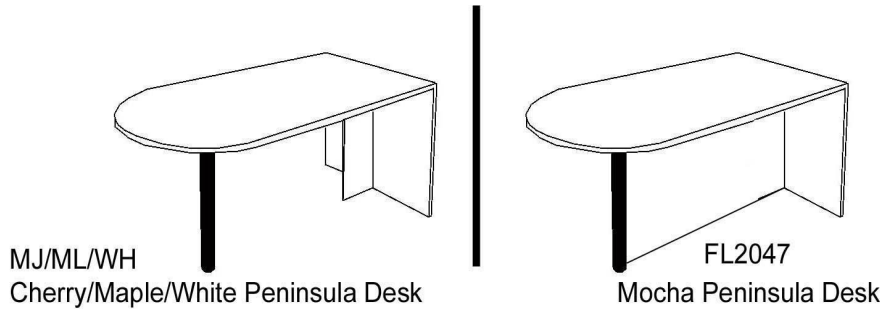

Applies to:
(BK/CH/MJ/ML/MWAL/WH)2047

List of Hardware:

Part	Part
 Wood Dowel	 Cap
 M6 Screw	 Leveling Glide
 Cam Lock & Pin Set	

- 1.) Assemble on carpet or cardboard to protect parts during assembly. Assembly will require 2 people for safety.
- 2.) Locate Post Leg. (You may need to tighten the connecting plate by tightening the screw inside the leg). Using the 4 M6 Machine Screws provided and screw the top of the leg into the underside of the peninsula desktop. The holes are piloted.
- 3.) Next, insert all dowels, cam pins and cam locks into the desktop, Side Panel and Support.
- 4a) If you have a Charcoal, Cherry, Maple or White Peninsula Desk, attach the Support and Side Panel together. Insert the dowels and cam pins into the corresponding holes and twist the cam locks with your screwdriver to secure (Fig. 1)
- 4b) If you have a Mocha Peninsula Desk, Attach the Support to the Post leg and Desktop first.

Tools Needed:
-Phillips Screwdriver
- A helper!

Special Note:

Location & number of cam pin, cam lock and dowel holes may vary.

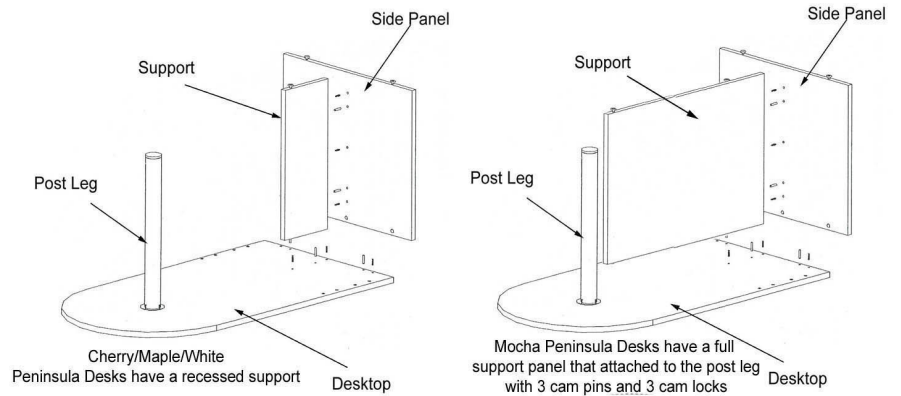
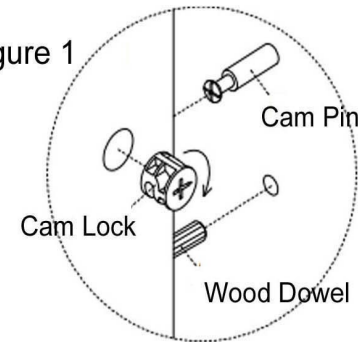

Figure 1



- 5a) If you have Charcoal, Cherry, Maple or White Peninsula Desk, your next step will be to attach the Support/Side Panel assembly to the desktop using the same hardware method.
- 5b) If you have a Mocha Peninsula Desk, your next step will be to attach the Side Panel to the Support and Desktop.
- 6) Insert all Leveling Glides and with a helper, carefully turn the desk upright.
- 7) Once in place, cover all Cam Locks with the Caps provided.

Questions? Please call 1-800-443-5117.

Customer Service available 8:30 - 5:00 Central Time, Monday - Friday

“BRACKETSET”

For Emerge Series 2-Person Shared Peninsula Reception Desk

Final Set Up Instructions:

1.) After your Peninsula Desk and Side Desks with Reception Caps are fully assembled, locate the bag of 8 L-Brackets and 32 wood screws. Place the Side Desks on both sides of the Peninsula Desk and butt them together tightly. The Front Panel of the Peninsula Desk should be flush with the edges of the Side Panels of the Side Desks.

2.) Using a power screwdriver, install 4 L-Brackets per side as shown in the diagrams. Use the self drilling wood screws to attach the brackets.

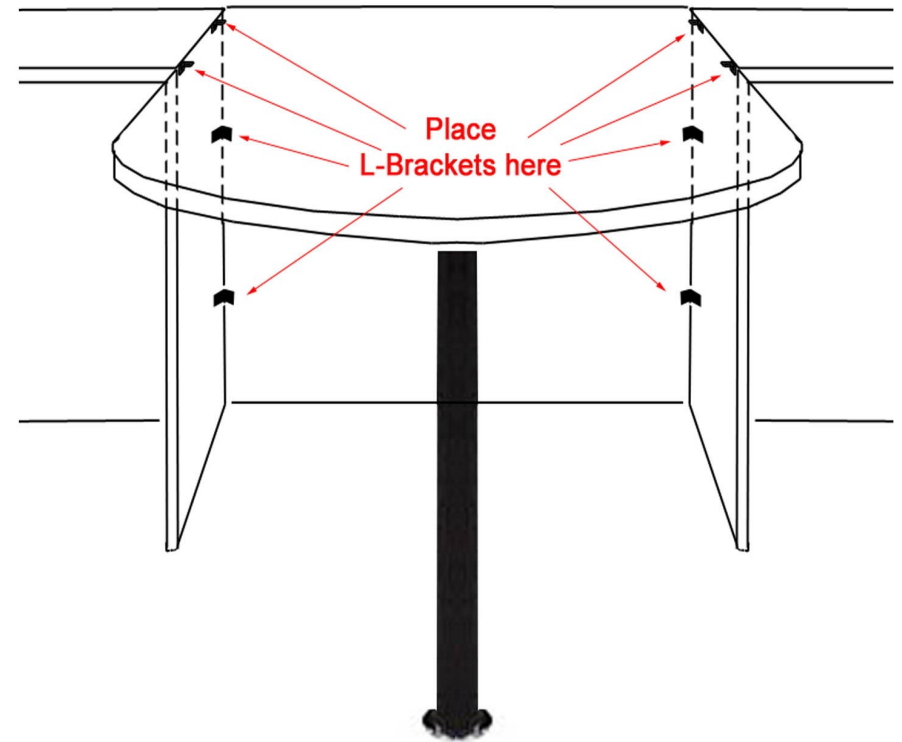

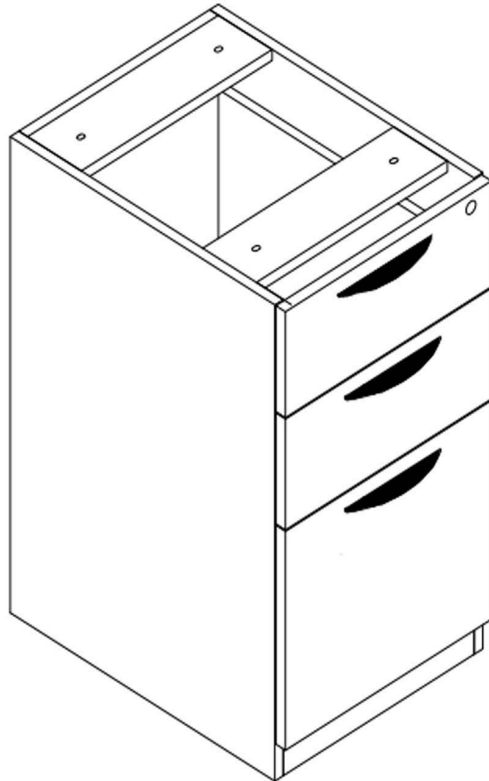

Box/Box/File Desk Pedestal Assembly Instructions

Applies towards:
BK/CH/FL/MJ/ML/WH2066

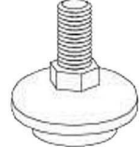

List of Hardware:

Part	Part
 4 Large Bolts	 3 Drawer Pulls with screws
 1 set of keys	 4 Leveling Glides

- 1.) Install 4 leveling glides.
- 2.) Use the screws to attach drawer pulls.
- 3.) To install under desk, remove the top box drawer (or top two box drawers) by locating the black tabs inside of the left & right drawer slides. Push down on one and push up on the other. This will release the drawer from the slides. Use 4 large bolts to connect to threaded holes on underside of desk. Once done, simply insert drawers back into the slides. They will snap in place.

Questions? Please call 1-800-443-5117.

Customer Service available 8:30 - 5:00 Central Time, Monday - Friday