

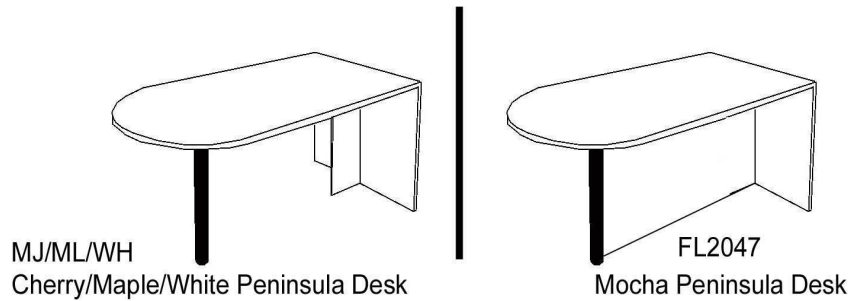

## Peninsula Desk Assembly Instructions



Applies to:  
(BK/CH/MJ/ML/MWAL/WH)2047

### List of Hardware:

Part	Part
 Wood Dowel	 Cap
 M6 Screw	 Leveling Glide
 Cam Lock & Pin Set	

### Tools Needed:

- Phillips Screwdriver
- A helper!

- 1.) Assemble on carpet or cardboard to protect parts during assembly. Assembly will require 2 people for safety.
- 2.) Locate Post Leg. (You may need to tighten the connecting plate by tightening the screw inside the leg). Using the 4 M6 Machine Screws provided and screw the top of the leg into the underside of the peninsula desktop. The holes are piloted.
- 3.) Next, insert all dowels, cam pins and cam locks into the desktop, Side Panel and Support.
- 4a) If you have a Charcoal, Cherry, Maple or White Peninsula Desk, attach the Support and Side Panel together. Insert the dowels and cam pins into the corresponding holes and twist the cam locks with your screwdriver to secure (Fig. 1)
- 4b) If you have a Mocha Peninsula Desk, Attach the Support to the Post leg and Desktop first.

### Special Note:

Location & number of cam pin, cam lock and dowel holes may vary.

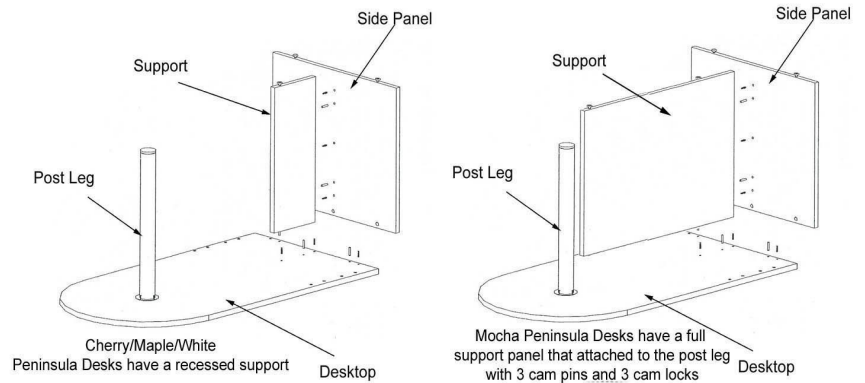
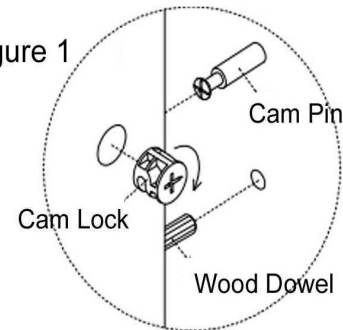

Figure 1



- 5a) If you have Charcoal, Cherry, Maple or White Peninsula Desk, your next step will be to attach the Support/Side Panel assembly to the desktop using the same hardware method.
- 5b) If you have a Mocha Peninsula Desk, your next step will be to attach the Side Panel to the Support and Desktop.
- 6) Insert all Leveling Glides and with a helper, carefully turn the desk upright.
- 7) Once in place, cover all Cam Locks with the Caps provided.

Questions? Please call 1-800-443-5117.





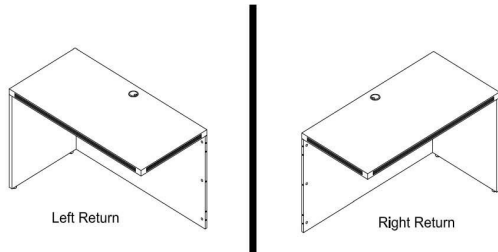





Customer Service available 8:30 - 5:00 Central Time, Monday - Friday

# Reversible Desk Return Assembly Instructions



Applies to:  
BK/CH/FL/MJ/ML/WH2045

## List of Hardware:

Part	Part	Part
		
		
		
		

## Tools Needed:

- Phillips Screwdriver
- Power Screwdriver
- A Helper

- 1.) Assemble on carpet or cardboard to protect parts during assembly. Assembly will require 2 people for safety.
- 2.) Determine if the return will be left or right handed (see diagram next page). Locate Side Panel & End Panel and arrange like shown in drawing. Insert leveling glides, then insert all cam pins, cam locks and wood dowels. Then connect the panels by inserting the dowels into the holes on opposite panel and inserting cam pins into cam locks (see diagram). Then, twist the cam locks with a Phillips Screwdriver to secure connection.
- 3.) Next, locate the Desktop and insert hardware. Then, set the desktop on the lower assembly and twist cams to securely connect.

## Special Note:

Location & number of cam pin, cam lock and dowel holes may vary.

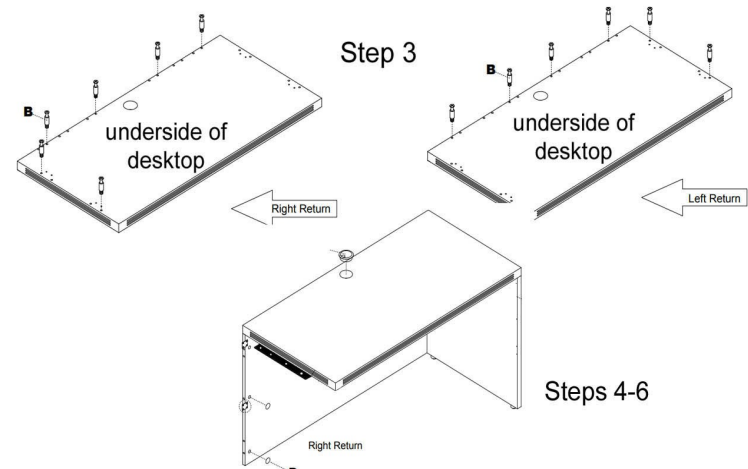
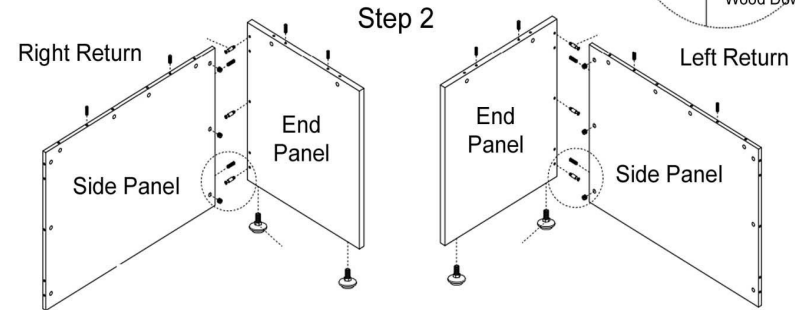
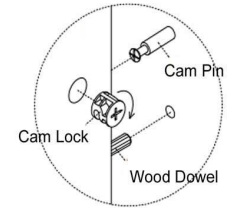

- 4.) Now it's time to attach the return to your desk. Locate the large flat bracket and M6 machine screws (it may be attached to the desktop already. If not, center the bracket over the edge and install 4 of the screws). With a helper, have one person hold the return desk stable while the other screws the machine screws into the desk.
- 5.) Once installed & leveled, use the wood screws to install the offset side panel brackets. This will further secure the side panel, but is an optional step. A power screwdriver is helpful.
- 6.) Lastly, insert the grommet into the desktop and use the caps provided to cover the cam locks.

Questions? Please call 1-800-443-5117.



Customer Service available 8:30 - 5:00 Central Time, Monday - Friday

## Box/Box/File Desk Pedestal Assembly Instructions

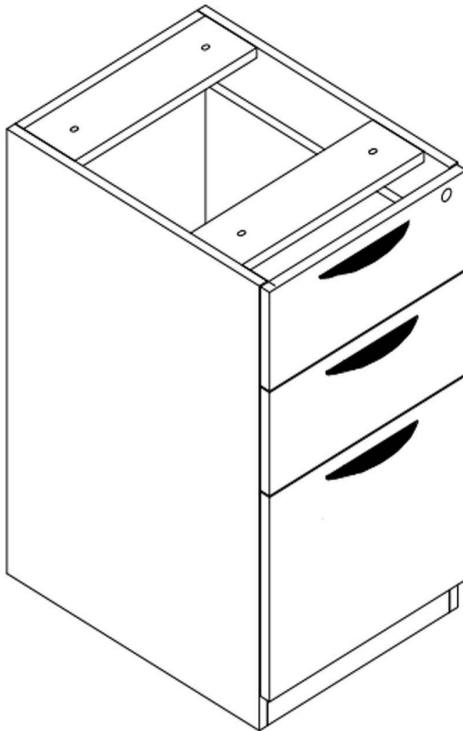
Applies towards:  
BK/CH/FL/MJ/ML/WH2066

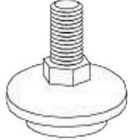

### List of Hardware:

Part	Part
 4 Large Bolts	 3 Drawer Pulls with screws
 1 set of keys	 4 Leveling Glides



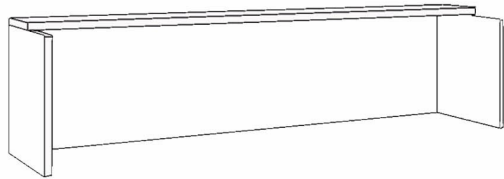

- 1.) Install 4 leveling glides.
- 2.) Use the screws to attach drawer pulls.
- 3.) To install under desk, remove the top box drawer (or top two box drawers) by locating the black tabs inside of the left & right drawer slides. Push down on one and push up on the other. This will release the drawer from the slides. Use 4 large bolts to connect to threaded holes on underside of desk. Once done, simply insert drawers back into the slides. They will snap in place.

## 66"W & 71"W White Risers Assembly Instructions



**Applies to:**  
WH2090, WH2095

### List of Hardware:

Part	Part
 Wood Dowel	 Cover
 Cam Pin	 Cam Lock

**Tools Needed:**  
-Phillips Screwdriver  
- A helper!

- 1.) Assemble on carpet or cardboard to protect parts during assembly.
- 2.) First attach the Front Panel to one of the Side Panels using the cam lock/pin hardware provided. **DO NOT FULLY TIGHTEN THE CONNECTION!** Leave yourself wiggle room for the coming steps.
- 3.) Repeat process for the other Side Panel.
- 4.) Next, insert any/all wooden dowels, cam locks and pins into the Front Panel and Side Panels to connect the CounterTop. Set Countertop on top of the assembly, over the pins & dowels.
- 5.) Once all parts are connected, tighten down all of the cam locks.

### Special Note:

Location & number of cam pin, cam lock and dowel holes may vary.

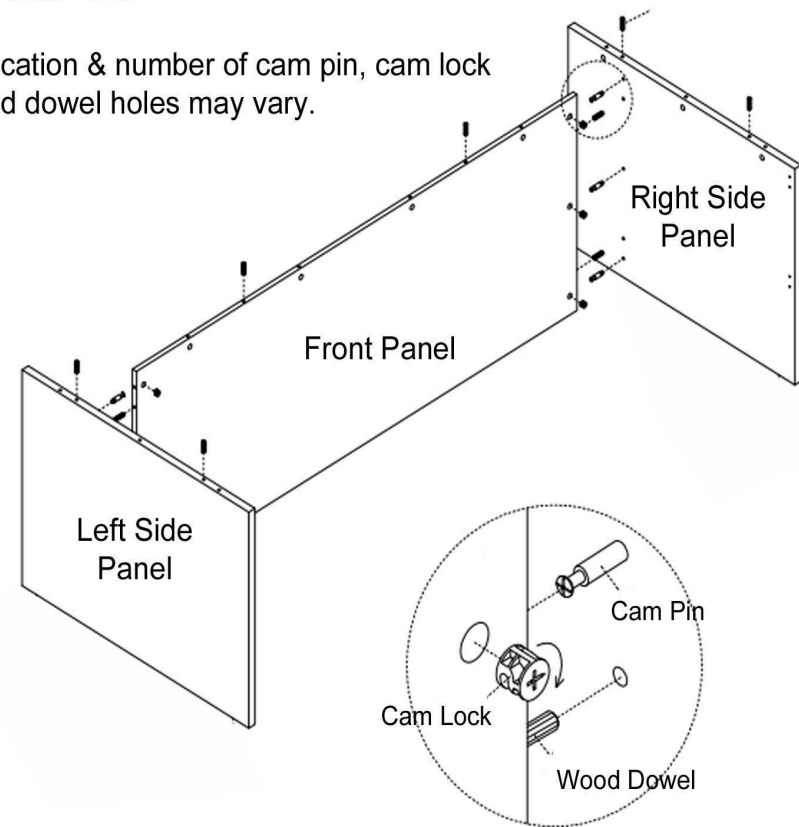

6.) With a helper, carefully lift the assembled Riser onto your desk. Remove the backing of the double sided tape at the bottom of the Side Panels and carefully place the riser down. After 24 hours, the tape will have a firm hold and the riser cannot be removed or budged.

7.) Cover any cam locks with white cam lock cover stickers.

**Questions? Please call 1-800-443-5117.**  
Customer Service available 8:30 - 5:00 Central Time, Monday - Friday