

## Solid Wood Top Parsons Leg Conference Table Assembly Instructions



### Tools Needed

- A helper
- 5 mm Allen Wrench (provided)
- Rubber Mallet
- Power Drill or Screwdriver
- WD40 or similar lubricant

### Included with 9' Tables:



Quantity of Table Tops will vary depending on table size:

- 9' - Qty 3, 3'x4' Tops
- 12' - Qty 3, 4'x4' Tops
- 15' - Qty 5, 3'x4' Tops

### Hardware Included:



### Included with tables 12'-15': (Add-on Frame)

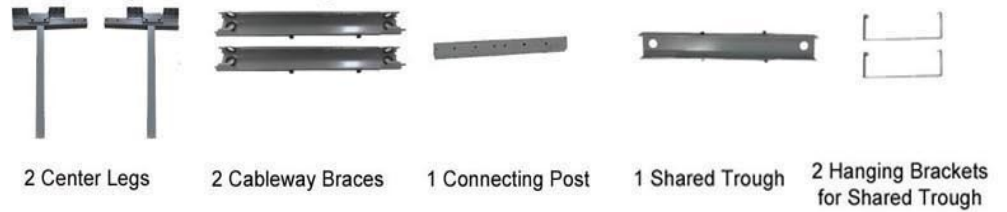

### Hardware Included:



### Step 1

Locate your first set of end frames, one connecting post and two tension knobs. The connecting post will have holes drilled on two sides of the square tube. Make sure these holes line up with the holes on the end frames. Insert the connecting post into the end frames. If post does not slide by hand, try a few squirts of WD40 and tap the frames with a rubber mallet until the post slides in. Position the connecting post as shown in the diagram below. Once the holes are aligned, screw in two tension knobs.



### Step 2

Locate the 2 Center Legs, one connecting post and two tension knobs. Repeat the same steps as described above for the Center Legs and attach connecting post in same way.

### Step 3

Locate two cableway braces. Remove all tension knobs on the braces. The cableway braces fit into the end frames by hand, by inserting the tabs into the slots on the end frames. With two people, have one person hold the end frame upright while the other inserts the cableway braces. Then, using a rubber mallet, tap down on the cableway braces to lock into the frame.

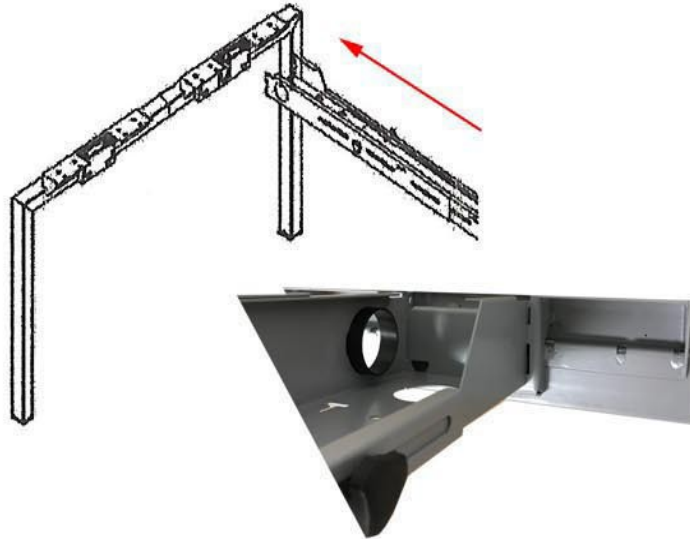

### Step 4

Now, repeat the same process with the center legs. Connect the other sides of the cableway braces to the center legs in the same manner. Once done, the metal frame will look like this:



### Step 5

For the next step you will need four flat brackets, eight M6 screws and the Allen Wrench provided. Connect the flat brackets to the tops of the cableway braces with two screws each:



### Step 6

The metal frames are adjustable in width/depth to fit many table top sizes. The cableway braces slide in and out so you can adjust the frame to fit your table top size.

Use the diagrams below to help guide you on leg/top placement. With a helper, push/pull the frame until it is specified to your correct measurement. Once correct, insert the tension knobs into the braces and fully tighten.



9'

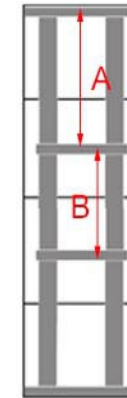

12'

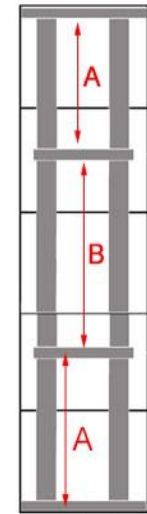

15'

**"A" Measurements (Estimated)**

**9' - 54"**

**12' - 54" (B Measurement 36")**

**15' - 59-1/2" (B Measurement 72")**



## Step 7

If you purchased a 12' or 15' table, your next step is to assemble the "Add On Frame", or additional center leg shown on Page 1. Use one connecting post and two tension knobs, just like shown in Step 2. Then repeat Steps 3-6 to connect the Cableway Braces, Flat Brackets and adjust the width of the frames to fit the table tops.

If you purchased a 9' table, locate your last set of End Frames and assemble as shown in Step 1. Then repeat Steps 3-6 to connect Cableway Braces, Flat Brackets and adjust the frame to fit the table tops.



Frame for an 8' table shown.

## Step 8

The next step is to attach the flat brackets to the table tops. Use two brackets per seam. Set the table tops on the metal frame and position, making sure the table tops are flush without any gaps. Center the brackets over the seams and use a power screwdriver to drill the 1" wood screws directly into the underside of the table top.

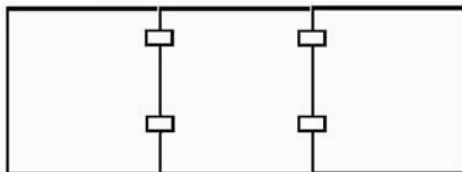

## Step 9

Next, use the smaller wood screws to connect the table tops to the metal frame. Using a power screwdriver and a help to hold down the table tops, drill in the screws from the underside of the welded desktop brackets, directly into the underside of the table tops.

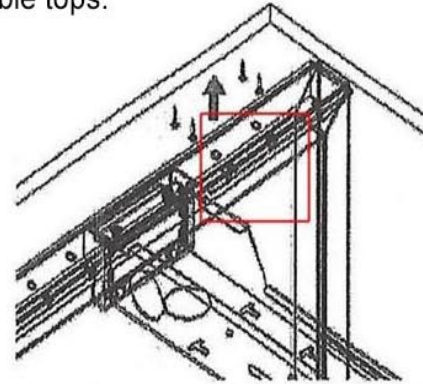

## Step 10: Optional

Included with your metal frame are Shared Cable Troughs. These are optional and can be used if you plan to install grommets or power modules into your table tops. The Shared Cable Troughs allow you to route cords from modules or grommets on the table top and keep them neatly organized and concealed inside the trough.

To attach, clip the Hanging Brackets onto the Shared Cable Troughs by hand. The snap on to the sides of the troughs.

Using two wood screws per bracket, attach the Shared Cable Troughs by center them underneath the table tops.

View from underside Table Tops

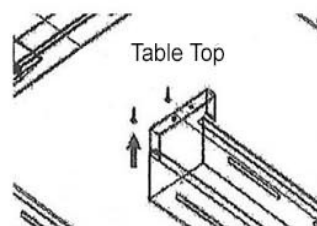

Positioning of Shared Cable Troughs shown in yellow

