

Oval Racetrack 2-Piece Top Conference Table Assembly Instructions

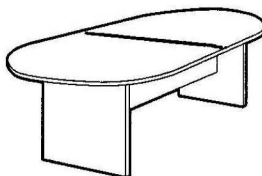







Special Note: Assemble in area you plan to use conference table to avoid moving the table once assembled. If you need to move your table after it is assembled, do not lift the table top without supporting the bases by hand or by furniture dollies. Never drag an assembled table across a floor.



Applies towards:

- FL/MJ/ML2036-2PCTOP
- MJ2037C
- MJ2038C
- 1009-CHV/MHV/ESV
- 1010-CHV/MHV/ESV

List of Hardware:

Part	Part	Part
 Wood Dowel	 Shallow Cover	 Bracket
 Cam Pin	 Deep Cover	 Wood Screw
 Cam Lock		 Leveling Glide

Tools Needed:

- Phillips Screwdriver
- Power Screwdriver
- A Helper

- 1.) Insert leveling glides into Table Bases.
- 2.) Next, insert all cam pins, cam lock and wood dowels into Table Bases and Strecher(s).
- 3.) With a helper, have one person insert the Strecher(s) into one of the Table Bases and twist Cam Locks with your screwdriver to secure the connection (See Fig 1). If you have a second Stretcher, repeat this step to connect.
- 4.) Attach the second Table Base in the same method.
- 5.) Next, insert all dowels and cam pins into the underside of the table top.

Special Note:

Location & number of cam pin, cam lock and dowel holes may vary.

Figure 1

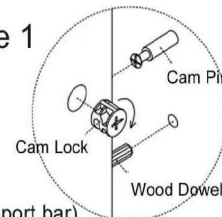

Some models of table have 1 stretcher (aka support bar) while some models have 2.

Steps 2-4

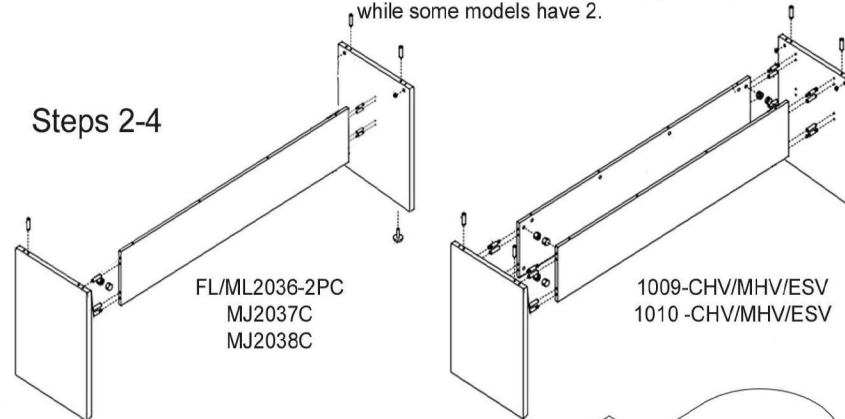

FL/ML2036-2PC
MJ2037C
MJ2038C

1009-CHV/MHV/ESV
1010-CHV/MHV/ESV

Step 5

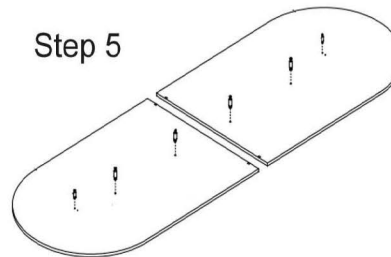

Step 6

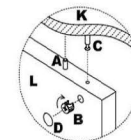
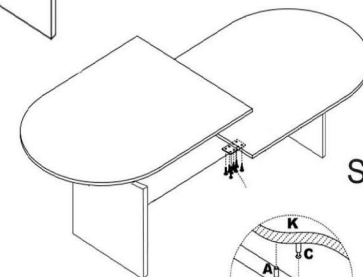

6.) With a helper, set the first table top on top of the table base assembly, making sure to insert the wood dowels and cam pins into the corresponding holes in the top edges of the Table Bases and Stretcher(s). Once fastened, repeat this step with the other table top.

7.) Next, locate the two flat Brackets and Wood Screws. Have your helper hold the two table tops to stabilize and have the other person center the brackets over the seam and drill in the wood screws to connect.

8.) Your last step is to insert the Shallow Covers and Deep Covers over the Cam Locks. Use Deep Covers on the Cams Locks on the Stretcher(s)

Questions? Please call 1-800-443-5117.

Customer Service available 8:30 - 5:00 Central Time, Monday - Friday