

2-Door Cabinet Assembly Instructions

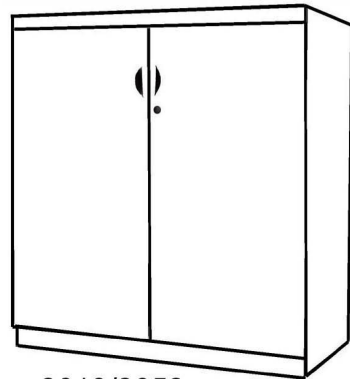

2013/2052

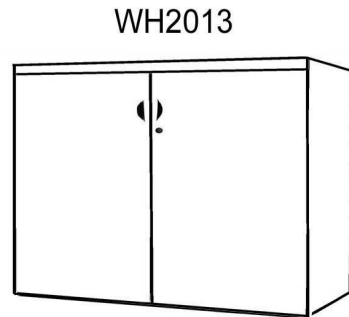

WH2013

Applies Towards:

FL/ML/MJ/WH2013













WH2013A

FL/ML/MJ2052

Tools Needed:

- Phillips Screwdriver
- A Helper

List of Hardware:

		
Wood Dowel	Shelf Pin	Hinge
		
Cam Pin	Plunger Lock	Hinge Plate
		
Cam Lock	Leveling Glide	Lock/Key
		
Door Pull	Shallow Cover	Deep Cover

Step 1.) *For 2013 and 2052 cabinets only.* Attach Toe Kick to Bottom Panel with cam pins & locks. Assemble upside down.

Step 2.) *(For all cabinets)* Attach Back Panel to Bottom Panel with cam pins & locks.

Step 3.) Attach Left & Right Side Panels in same manner.

Step 4.) Attach Top Surface with cam locks, cam pins and dowels. Then, insert the four leveling glides.

Step 5.) Insert shelf pins into holes along the interior sides. Place Shelf on top of the pins.

Step 6.) Attach four hinge plates with the screws included. The holes are piloted. **DO NOT TIGHTEN ALL OF THE WAY! LEAVE WIGGLE ROOM FOR ADJUSTMENT LATER ON.**

Special Note:

Location & number of cam pin, cam lock and dowel holes may vary.

Step 1

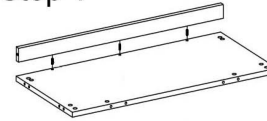

Step 3

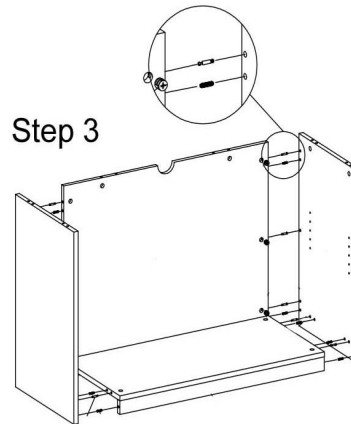

Step 5

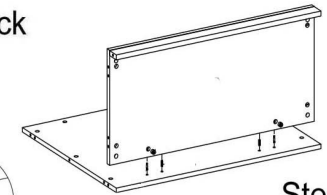
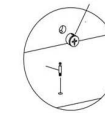
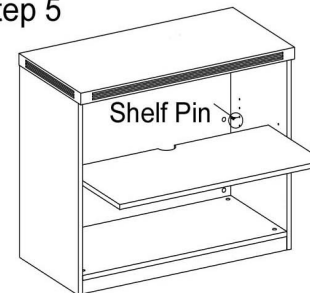

Step 2

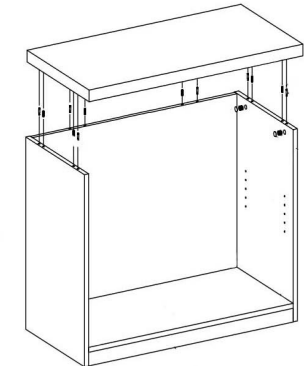

Step 4



Hinge Adjustment

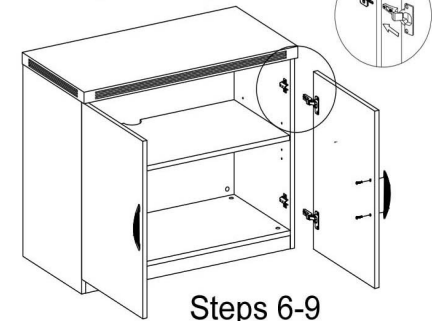

Steps 6-9

Step 7.) Attach two hinges per door. The holes are piloted. Then, insert the hinges into the hinge plates inside the cabinet. Connect with screws.

Step 8.) Attach the door pulls with the screws included. Insert shallow & deep covers over cam lock holes. Deep covers are for interior cams, shallow are for the back panel cams.

Step 9.) Once you have the cabinet in the place you intend to use it, it will be time to adjust the hinges to align the doors. Using your screwdriver, turn the set screw on the hinge to adjust the depth and the screws on the hinge plate to move the door up/down. See diagram above.

Step 10.) Your last step is to insert the shallow & deep covers over the cam locks and to attach the plunger lock and lock core. Locate the pre-drilled notch on the underside of the Top Surface. Attach plunger lock so it inserts into the notch when pushed in. Attach the lock core with four screws provided.

Questions? Please call 1-800-443-5117.

Customer Service available 8:30 - 5:00 Central Time, Monday - Friday