

Flip N' Stow Flip Top Table Assembly Instructions











Video for Table Base Assembly



Video for attaching Table Top



Special Note: The laminate table tops you received are multi-purpose, meaning, they are used throughout many furniture series. Due to this, you will notice pre-drilled inserts on the underside of the table tops. You are to disregard those holes as they are for a different series. Use the wood screws provided and a power screwdriver to make your own holes and attach the top to the flip top table base.

A		TOP
		QTY 1
B		FRAME
		QTY 1
C		BASES
		QTY 2
D		SCREW ST4*16
		QTY 8
E		SCREW ST4*40
		QTY 6
F		BOLT
		QTY 4
G		LOCK WASHER
		QTY 4
H		WASHER
		QTY 4
J		ALLEN WRENCH
		QTY 1

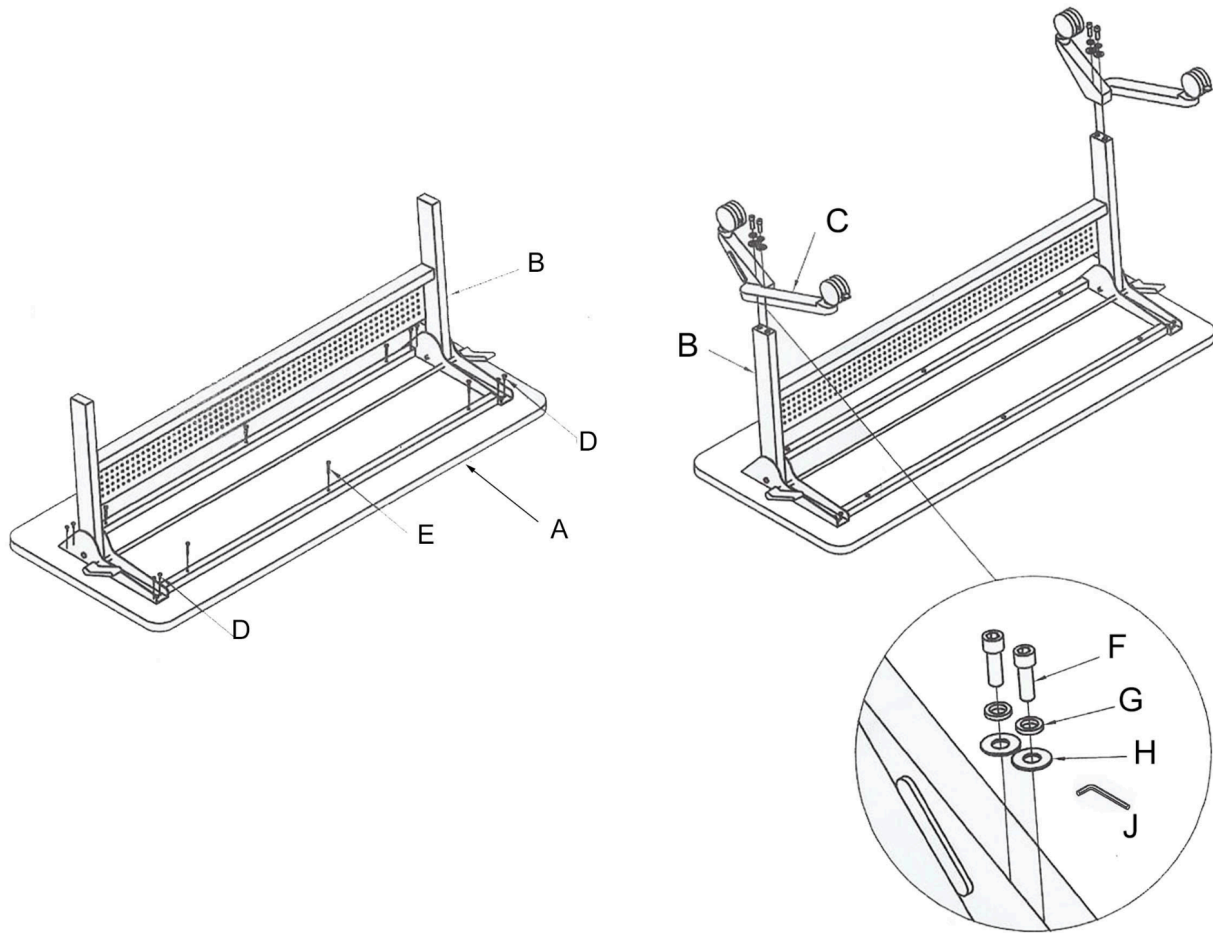

Questions? Call Customer Service at 1-800-443-5117 Mon-Fri, 8:30-5PM Central Time or email at CustomerSvc@ModernOfficeFurniture.com