















# Sterling Heavyweight Airport Beam Seating Assembly Instructions

No.	Part	Description	1 Seat	2 Seat	3 Seat	4 Seat	5 Seat	
1		Seat	1	2	3	4	5	
2		Seat Bracket (Left)	1	2	3	4	5	
3		Seat Bracket (Right)	1	2	3	4	5	
4		Seat to Bracket Bolt	8	16	24	32	40	
5		Beam	1					
6		Beam to Bracket Bolt	4	8	12	16	20	
7		Feet	4				6	
8		Left Leg	1					
9		Right Leg	1					
10		Left Arm	1					
11		Right Arm	1					
not shown		Center Leg (5-Seat Only)	n/a				1	
12		Beam to Leg Bolt	4				6	
Tool		Allen Wrench	1					
Tool		Allen Wrench Extender	1					

Instructions apply to 1-Seaters, 2-Seaters, 3-Seaters, 4-Seaters and 5-Seaters, although a 3-Seater is illustrated for reference

1

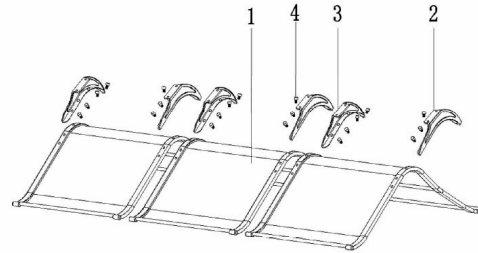

Start by attaching Seat Brackets to Seats

2

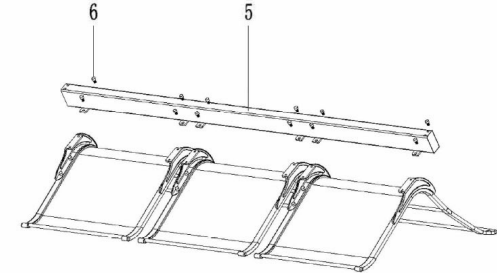

Next, attach the Beam.

3

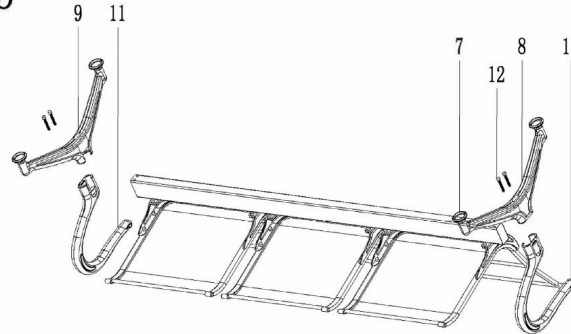

Attach Armrests and Legs. Screw in Feet to Legs.

4

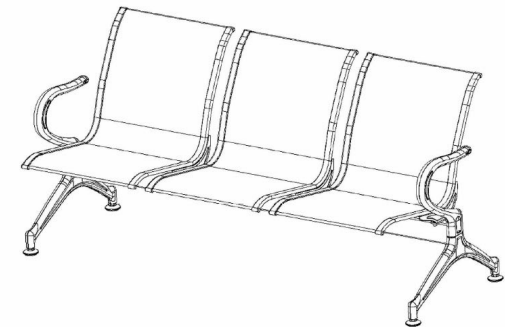

With a helper, carefully turn the unit upright.

## Fully Upholstered Beam Seating Cushion Installation Guide

EACH SET INCLUDES: 1 BACK CUSHION, 1 SEAT CUSHION, 1 MIDDLE CUSHION AND 12 SELF-DRILLING SCREWS

Side Profile of Seat Cushion  
Curved on one end only



Side Profile of Back Cushion  
Small Curve on one end, Large Curve on other

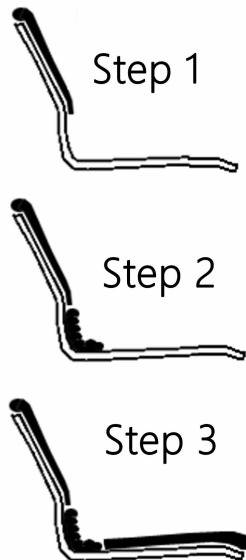

Step 1) Start with Back Cushions. Use 4 screws to attach the cushion, one screw per corner.

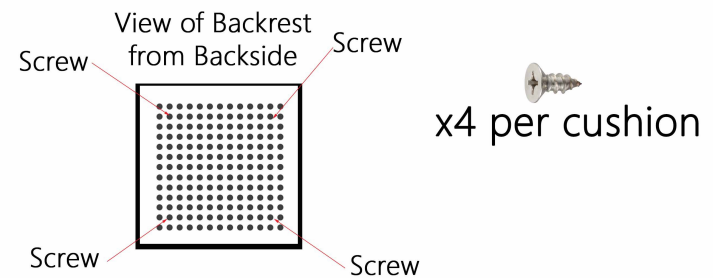

Step 2) Attach Middle Cushion in same method.

Step 3) Turn Beam Seater over to attach the seat cushions.