

4 -Door Cabinet Assembly Instructions

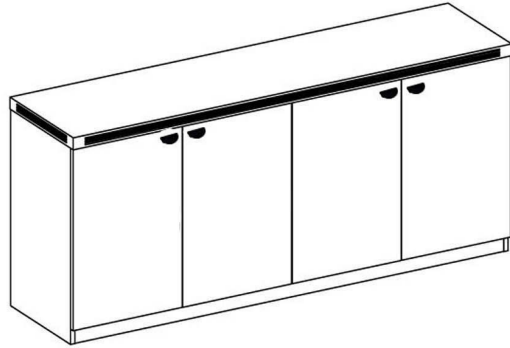

Applies Towards:

BK/CH/FL/MJ/ML/WH2051A











Tools Needed:

- Phillips Screwdriver
- A Helper

Special Note:

Location & number of cam pin, cam lock and dowel holes may vary.

List of Hardware:

 Wood Dowel	 Shelf Pin	 Hinge
 Cam Pin	 Plunger Lock	 Hinge Plate
 Cam Lock	 Leveling Glide	 Lock/Key
 Door Pull	 Shallow Cover	 Deep Cover

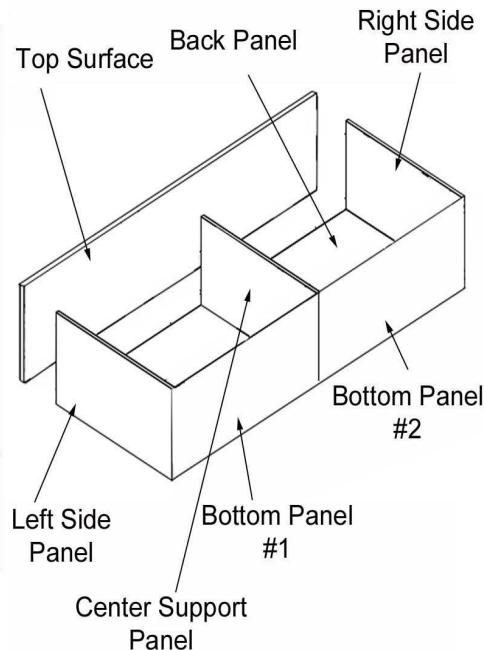

1.) Lay out all of the panels on a carpeted surface or on cardboard to protect during assembly. Insert all cam pins, cam locks and dowels into holes. Insert all 6 leveling glides into the Left & Right Side Panels and Center Support Panel.

2.) Attach the Center Support Panel to the Back Panel first, twisting the cam locks down with a Phillips Screwdriver to secure the connection.

3.) Next, attach Bottom Panel #1 and the Left Side Panel to Back Panel and Center Support Panel. You may need a helper to hold panels while another attaches.

4.) Repeat the process for Bottom Panel #2 and Right Side Panel.

5.) Attach Top Surface. The shell of the credenza is now complete. With a helper, carefully turn the unit upright.

6.) Insert 4 shelf pins per side and set the Shelves on top of the pins.

7.) Connect door pulls to the doors with screws provided, two screws per pull.

8.) Next, connect all 8 Hinge Plates to the inside of the credenza. The holes for are piloted. DO NOT TIGHTEN ALL OF THE WAY YET! Leave wiggle room for the upcoming steps.

9.) Attach the hinges to the doors. The inside doors will use the 'flat' hinges. The outer doors will have the hinges with the 'bump'. Once all are attached, slide the hinges onto the hinge plates inside the credenza and connect the hinges with the screws.

10.) The next step is to align the doors. Using your screwdriver, turn the set screw on the hinge to adjust the depth and the screws on the hinge plate to move the door up/down. Once aligned, you can tighten the hinges plates down all of the way.

11.) Insert covers over cam locks.

12.) Install Plunger Locks on each Left Side Door. Align the locks so that the plunger will insert into predrilled hole on underside of top surface when activated. Install Locks into right side doors using screws provided.

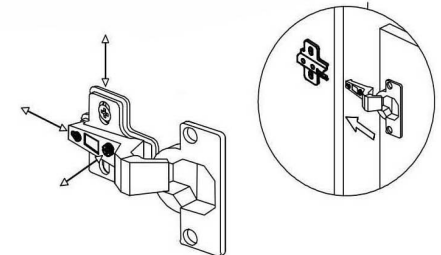
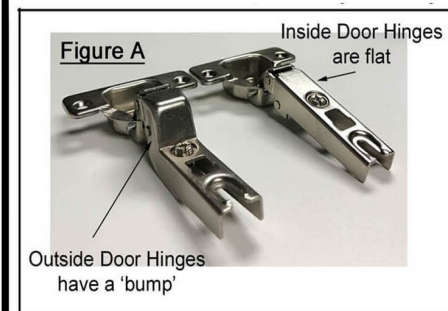

Questions? Please call 1-800-443-5117.

Customer Service available 8:30 - 5:00 Central Time, Monday - Friday

4-Door Hutch Assembly Instructions

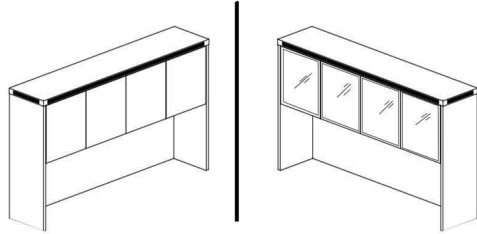





Applies to:
BK/CH/FL/MJ/ML/WH2044
MJ2025-CHL

Questions? Please call 1-800-443-5117.

Customer Service available 8:30 - 5:00 Central Time, Monday - Friday

List of Hardware:

Part	Part	Part
		Qty 4 
Wood Dowel	Cam Lock Cap	Outside Door Hinge
		Qty 4 
Cam Pin		Inside Door Hinge
		Qty 8 
Cam Lock	Grommet	Hinge Plate

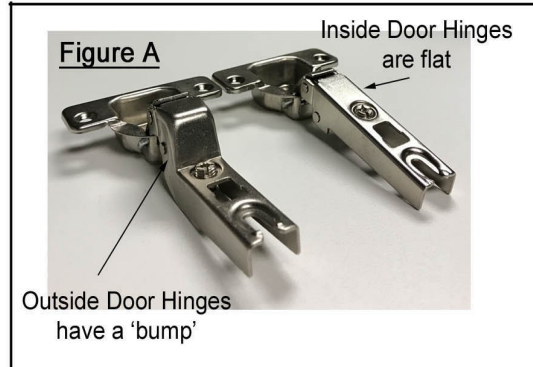

- 1.) Locate the Back Panel, Left & Right Side Panels and Center Shelf. Insert all wooden dowels, cam pins and cam locks. Connect Back Panel to the Center Shelf. Then connect the Left Side Panel, then Right Side Panel. Once all panels are connected, use your screwdriver to twist the cam locks to secure the connections.
- 2.) Connect the Middle Support Panel in same method.
- 3.) Attach Top Surface in same method.
- 4.) Attach all 8 Hinge Plates to the inside walls of the hutch. Use two per door. The holes are piloted. **DO NOT TIGHTEN DOWN THE SCREWS ALL OF THE WAY. LEAVE WIGGLE ROOM!**

Tools Needed:

- Phillips Screwdriver
- A Helper

Special Note:

Location & number of cam pin, cam lock and dowel holes may vary.

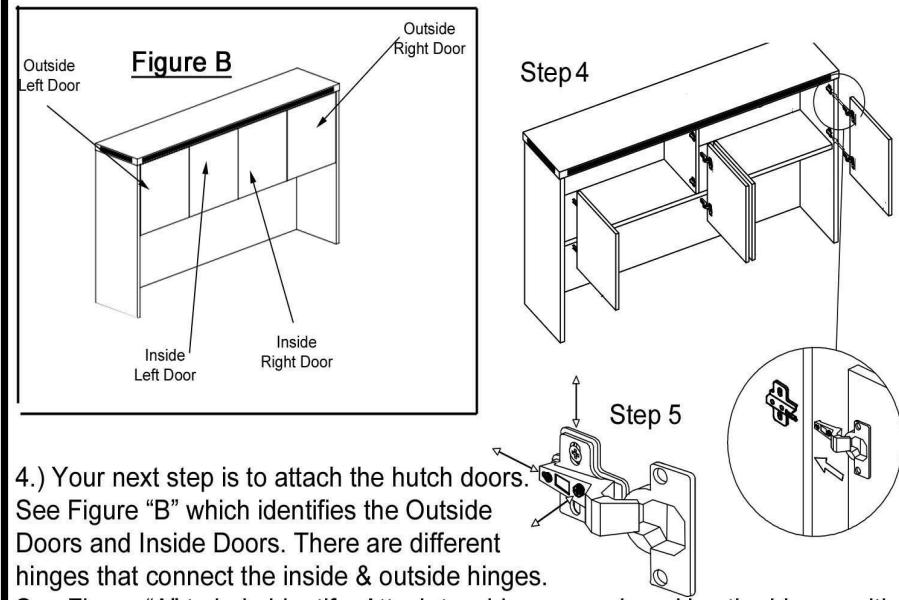
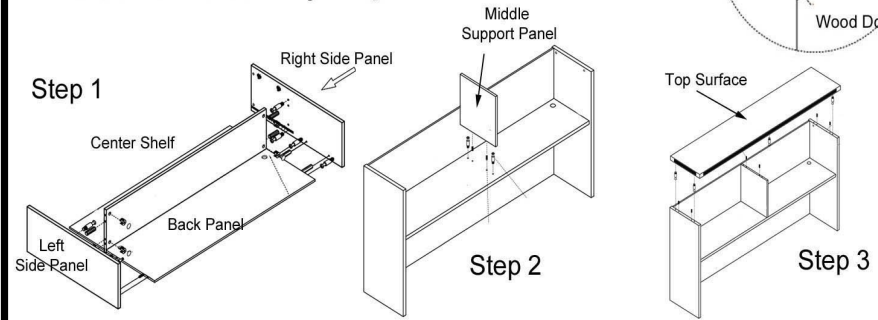
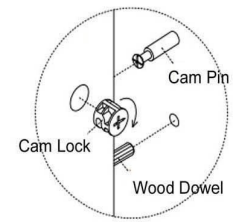

- 4.) Your next step is to attach the hutch doors. See Figure "B" which identifies the Outside Doors and Inside Doors. There are different hinges that connect the inside & outside hinges. See Figure "A" to help identify. Attach two hinges per door. Use the hinges with the 'bump' on the Outside Left & Right Doors and the flat hinges on the Inside Left & Right Doors. The holes are piloted. Use the screws provided. Once the hinges are attached, slide the hinges over the Hinge Brackets, fitting the screw head of the Hinge Bracket in the slot of the Hinge. Once fitted, slightly tighten the set screw. Now, set your hutch on your desk. Use the double-sided tape to securely adhere to desktop.
- 5.) Next, it is time to adjust the doors so that they properly align. Using your screwdriver, turn the Set Screw on the hinge to adjust the depth and the screws on the hinge plate to move the door up/down.
- 6.) Last step is to install Cam Lock Caps and Grommet cover.

Video on Hinge Door Adjustment available at link:
<http://www.modernofficefurniture.com/office-furniture-assembly-instructions.html>
"How to Adjust Hinges on 4-Door Hutch"