

Desk/Credenza Shell Assembly Instructions

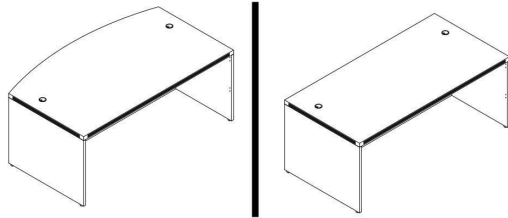

Applies to:

(BK/CH/MJ/ML/MWAL/WH) 2001/2002/2043/2089/3624/7124

List of Hardware:

Part	Part
 Wood Dowel	 Cap
 Cam Pin	 Leveling Glide
 Cam Lock	 Grommet

Tools Needed:

- Phillips Screwdriver
- A helper!

- 1.) Assemble on carpet or cardboard to protect parts during assembly. Assembly will require 2 people for safety.
- 2.) Locate left & right side panels. Screw in the leveling glides by hand. Then, insert wood dowels & cam pins. The wood dowels fit into the slightly larger holes, compared to the cam pin holes
- 3.) Locate front panel and insert all cam locks on the left & right sides. Then, align one of the side panels and connect the panel by inserting the cam pins into the cam locks and the dowels into the corresponding holes. (see diagram on next page). Twist the cam locks with a Phillips Screwdriver to secure.

Special Note:

Location & number of cam pin, cam lock and dowel holes may vary.

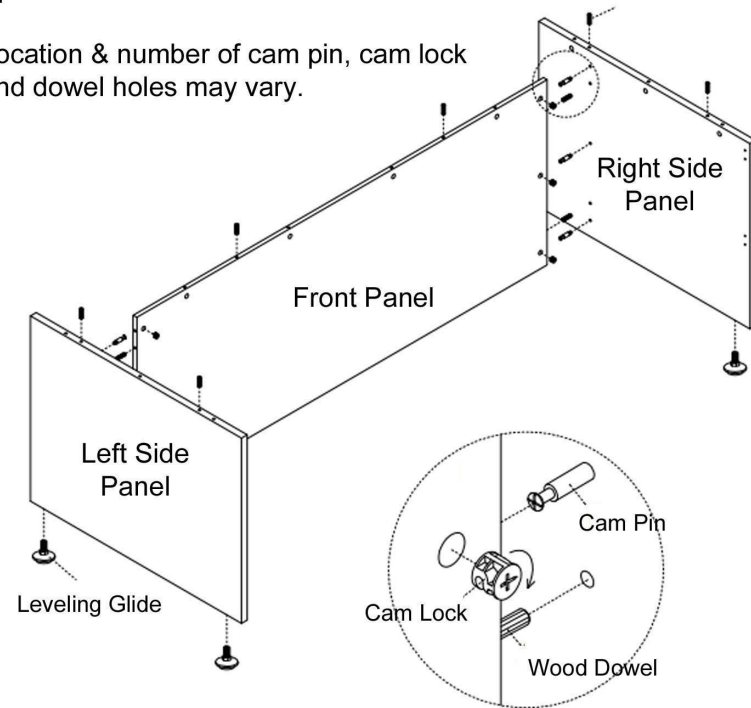

- 4.) Next, insert all cam pins, dowels and cam locks on the top edges of the side panels and front panels. Locate the desktop and with a helper, carefully set the desktop on top of the assembly shown above. Twist cam locks to secure the connection.

- 5.) Your last step is to insert the grommet(s) provided into the desktop. Cover the cam locks with the caps provided.

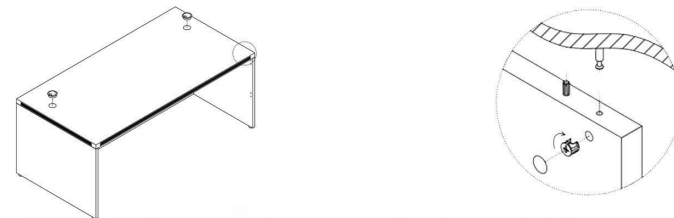

Questions? Please call 1-800-443-5117.





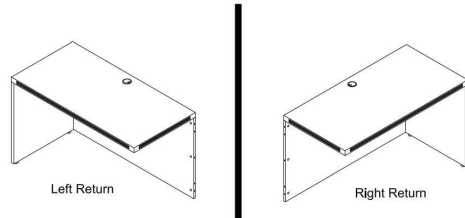





Customer Service available 8:30 - 5:00 Central Time, Monday - Friday

Reversible Desk Return Assembly Instructions



Applies to:
BK/CH/FL/MJ/ML/WH2045

List of Hardware:

Part	Part	Part
 Wood Dowel	 Shallow Cover	 Worksurface Bracket
 Cam Pin	 Deep Cover	 Side Panel Brackets (2)
 Cam Lock	 Grommet	 M6 Screw
 Wood Screw		 Leveling Glide

Tools Needed:

- Phillips Screwdriver
- Power Screwdriver
- A Helper

- 1.) Assemble on carpet or cardboard to protect parts during assembly. Assembly will require 2 people for safety.
- 2.) Determine if the return will be left or right handed (see diagram next page). Locate Side Panel & End Panel and arrange like shown in drawing. Insert leveling glides, then insert all cam pins, cam locks and wood dowels. Then connect the panels by inserting the dowels into the holes on opposite panel and inserting cam pins into cam locks (see diagram). Then, twist the cam locks with a Phillips Screwdriver to secure connection.
- 3.) Next, locate the Desktop and insert hardware. Then, set the desktop on the lower assembly and twist cams to securely connect.

Special Note:

Location & number of cam pin, cam lock and dowel holes may vary.

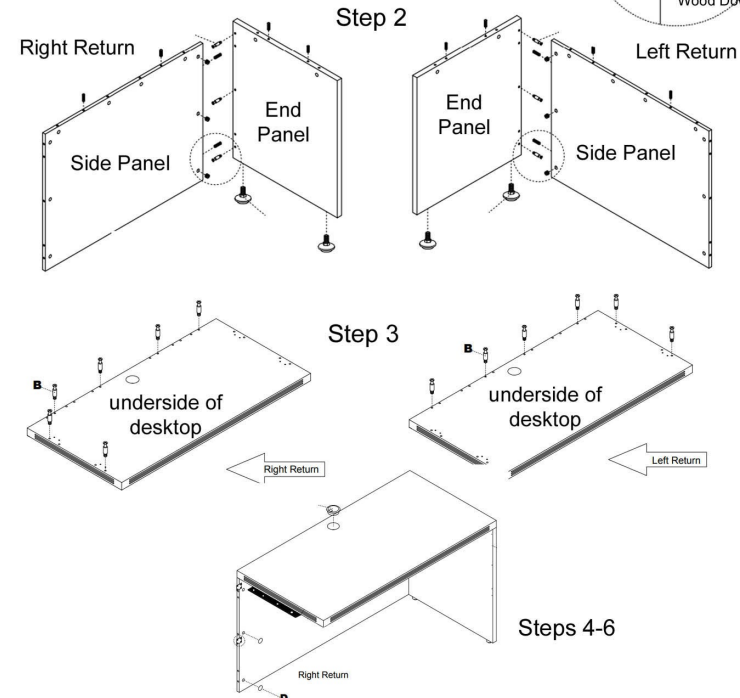
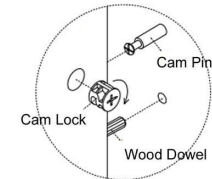

- 4.) Now it's time to attach the return to your desk. Locate the large flat bracket and M6 machine screws (it may be attached to the desktop already. If not, center the bracket over the edge and install 4 of the screws). With a helper, have one person hold the return desk stable while the other screws the machine screws into the desk.
- 5.) Once installed & leveled, use the wood screws to install the offset side panel brackets. This will further secure the side panel, but is an optional step. A power screwdriver is helpful.
- 6.) Lastly, insert the grommet into the desktop and use the caps provided to cover the cam locks.

Questions? Please call 1-800-443-5117.



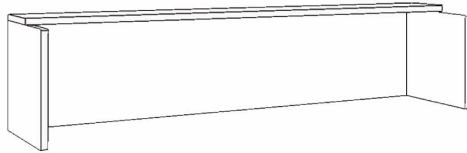

Customer Service available 8:30 - 5:00 Central Time, Monday - Friday

66"W & 71"W White Risers Assembly Instructions



Applies to:
WH2090, WH2095

List of Hardware:

Part	Part
	
Wood Dowel	Cover
	
Cam Pin	Cam Lock

Tools Needed:
-Phillips Screwdriver
- A helper!

- 1.) Assemble on carpet or cardboard to protect parts during assembly.
- 2.) First attach the Front Panel to one of the Side Panels using the cam lock/pin hardware provided. **DO NOT FULLY TIGHTEN THE CONNECTION!** Leave yourself wiggle room for the coming steps.
- 3.) Repeat process for the other Side Panel.
- 4.) Next, insert any/all wooden dowels, cam locks and pins into the Front Panel and Side Panels to connect the CounterTop. Set CounterTop on top of the assembly, over the pins & dowels.
- 5.) Once all parts are connected, tighten down all of the cam locks.

Special Note:

Location & number of cam pin, cam lock and dowel holes may vary.

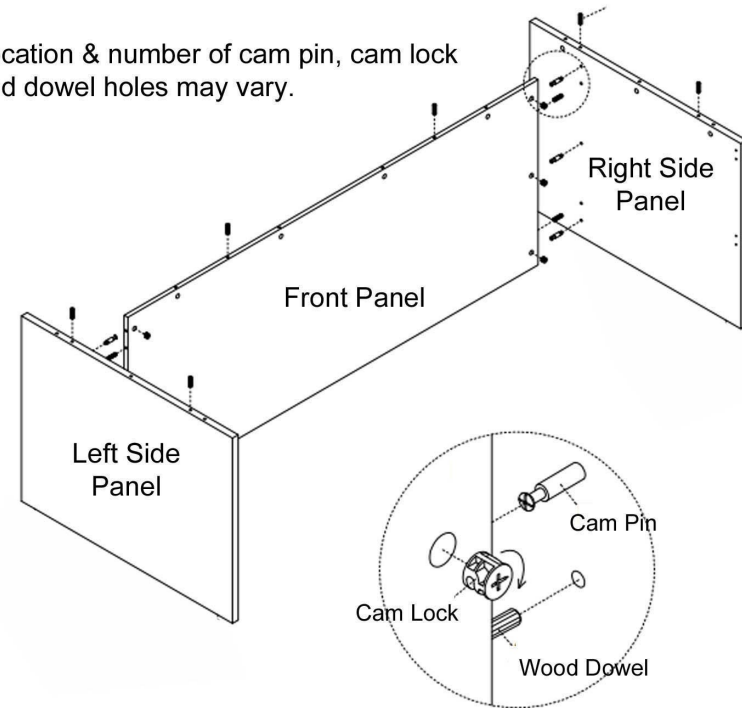

- 6.) With a helper, carefully lift the assembled Riser onto your desk. Remove the backing of the double sided tape at the bottom of the Side Panels and carefully place the riser down. After 24 hours, the tape will have a firm hold and the riser cannot be removed or budged.
- 7.) Cover any cam locks with white cam lock cover stickers.

Questions? Please call 1-800-443-5117.
Customer Service available 8:30 - 5:00 Central Time, Monday - Friday