















Sterling Heavyweight Airport Beam Seating Assembly Instructions

Instructions apply to 1-Seaters, 2-Seaters, 3-Seaters, 4-Seaters and 5-Seaters, although a 3-Seater is illustrated for reference

No.	Part	Description	1 Seat	2 Seat	3 Seat	4 Seat	5 Seat	
1		Seat	1	2	3	4	5	
2		Seat Bracket (Left)	1	2	3	4	5	
3		Seat Bracket (Right)	1	2	3	4	5	
4		Seat to Bracket Bolt	8	16	24	32	40	
5		Beam	1					
6		Beam to Bracket Bolt	4	8	12	16	20	
7		Feet	4				6	
8		Left Leg	1					
9		Right Leg	1					
10		Left Arm	1					
11		Right Arm	1					
not shown		Center Leg (5-Seat Only)	n/a				1	
12		Beam to Leg Bolt	4				6	
Tool		Allen Wrench	1					
Tool		Allen Wrench Extender	1					

1

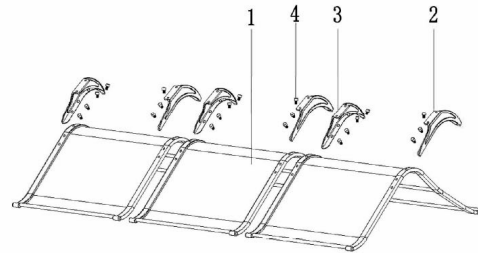

Start by attaching Seat Brackets to Seats

2

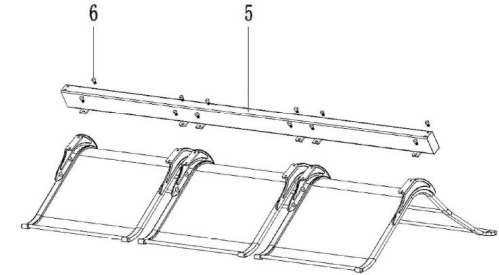

Next, attach the Beam.

3

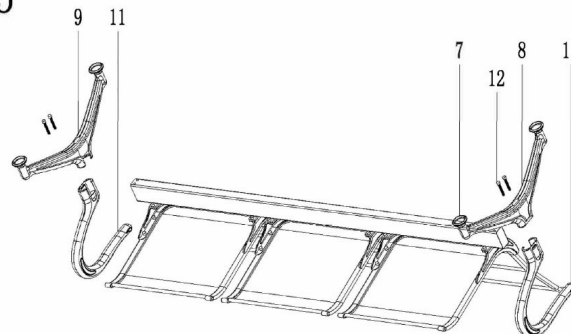

Attach Armrests and Legs. Screw in Feet to Legs.

4

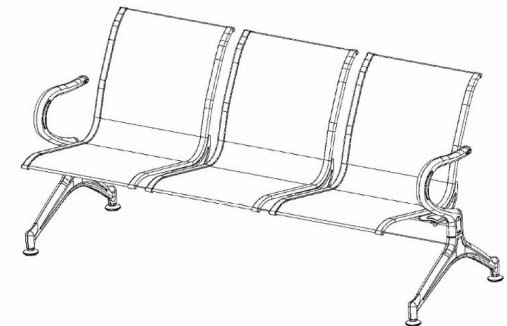

With a helper, carefully turn the unit upright.