

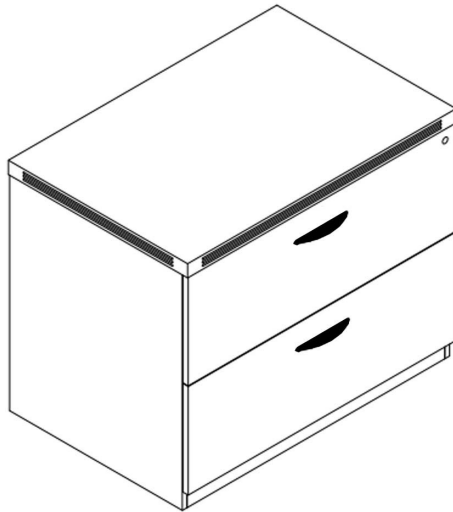



2, 3 & 4 Drawer Lateral File Assembly Instructions

Applies towards:

BK/FL/MJ/ML/WH2012
 WH2012A
 LF3622-MWAL
 LF3622-WH
 WH2012A-3DLF
 FL/MJ/ML/WH2012B

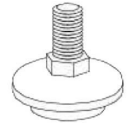

List of Hardware:

Part	Part
 Drawer Pull Screw 2 per drawer pull	 Drawer Pull 1 per drawer
 1 set of keys	 4 Leveling Glides

- 1.) Install 4 leveling glides. Keep the front two leveling glides 1/4" taller than the back back two, which means your file will be slightly tilted back. This is the proper way to level a lateral file cabinet. It keeps any unlocked file drawers from creeping open and distributes the weight more evenly.
- 2.) Use the screws to attach drawer pulls.

Questions? Please call 1-800-443-5117.
 Customer Service available 8:30 - 5:00 Central Time, Monday - Friday

2-Door Cabinet Assembly Instructions

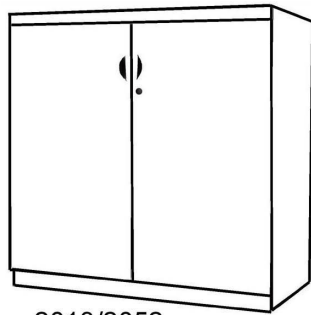

2013/2052

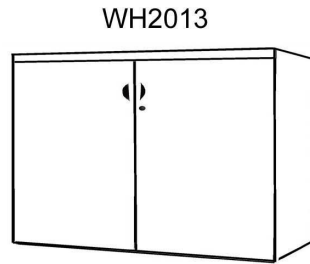

WH2013

Applies Towards:

FL/ML/MJ/WH2013













WH2013A

FL/ML/MJ2052

Tools Needed:

- Phillips Screwdriver
- A Helper

List of Hardware:

 Wood Dowel	 Shelf Pin	 Hinge
 Cam Pin	 Plunger Lock	 Hinge Plate
 Cam Lock	 Leveling Glide	 Lock/Key
 Door Pull	 Shallow Cover	 Deep Cover

Step 1.) For 2013 and 2052 cabinets only. Attach Toe Kick to Bottom Panel with cam pins & locks. Assemble upside down.

Step 2.) (For all cabinets) Attach Back Panel to Bottom Panel with cam pins & locks.

Step 3.) Attach Left & Right Side Panels in same manner.

Step 4.) Attach Top Surface with cam locks, cam pins and dowels. Then, insert the four leveling glides.

Step 5.) Insert shelf pins into holes along the interior sides. Place Shelf on top of the pins.

Step 6.) Attach four hinge plates with the screws included. The holes are piloted. DO NOT TIGHTEN ALL OF THE WAY! LEAVE WIGGLE ROOM FOR ADJUSTMENT LATER ON.

Special Note:

Location & number of cam pin, cam lock and dowel holes may vary.

Step 1



Step 3

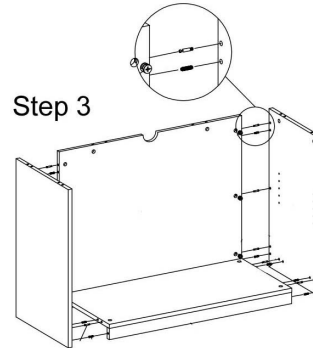

Step 5

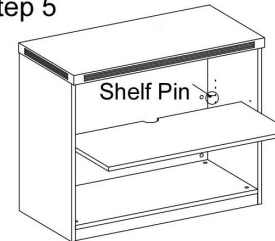

Hinge Adjustment

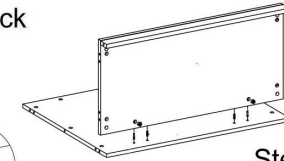

Step 2

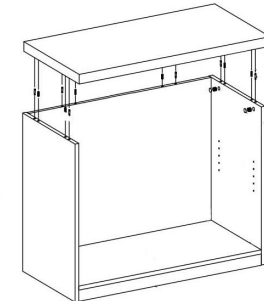

Step 4

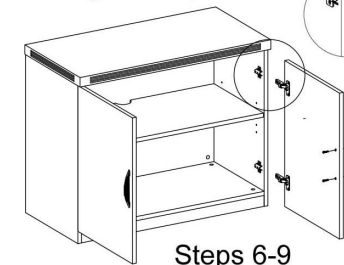

Steps 6-9

Step 7.) Attach two hinges per door. The holes are piloted. Then, insert the hinges into the hinge plates inside the cabinet. Connect with screws.

Step 8.) Attach the door pulls with the screws included. Insert shallow & deep covers over cam lock holes. Deep covers are for interior cams, shallow are for the back panel cams.

Step 9.) Once you have the cabinet in the place you intend to use it, it will be time to adjust the hinges to align the doors. Using your screwdriver, turn the set screw on the hinge to adjust the depth and the screws on the hinge plate to move the door up/down. See diagram above.

Step 10.) Your last step is to insert the shallow & deep covers over the cam locks and to attach the plunger lock and lock core. Locate the pre-drilled notch on the underside of the Top Surface. Attach plunger lock so it inserts into the notch when pushed in. Attach the lock core with four screws provided.

Questions? Please call 1-800-443-5117.

Customer Service available 8:30 - 5:00 Central Time, Monday - Friday

Y10406 - White Open Storage Unit Assembly Instructions

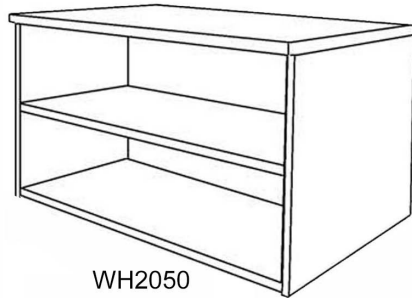

WH2050

PARTS LIST

Part	Part
 Wood Dowel	 Leveling Glide
 Cam Pin	 Shelf Pin
 Cam Lock	 Cap
	 Stickers

Tools Needed:
-Phillips Screwdriver
- A helper!

- 1.) Screw in all camlock pins and insert all wooden dowels in both SIDE PANELS, BACK PANEL, TOP and BOTTOM.
- 2.) Assemble the bookcase on its side. Begin by attaching the BOTTOM and one SIDE PANEL by placing it over the cam pins and inserting the cam locks. DO NOT YET TIGHTEN.
- 3.) Assemble the bookcase on its side. Begin by attaching the base with the trim piece by placing it over the cam pins and inserting the cam locks. DO NOT YET TIGHTEN.
- 4.) Connect BACK PANEL using same hardware method.
- 5.) Connect TOP and othe SIDE PANEL. When done, TIGHTEN ALL CAM LOCKS.
- 6.) Turn unit right side up and place in area of intended use. Insert shelf pins and SHELF where desired.
- 7.) Cover the cam locks with the caps provided.
- 8.) Use the stickers provided to cover any top surface pre-drilled holes, that won't be used to attach a hutch or desk frame.

Special Note:

Location & number of cam pin, cam lock and dowel holes may vary.

Figure 1

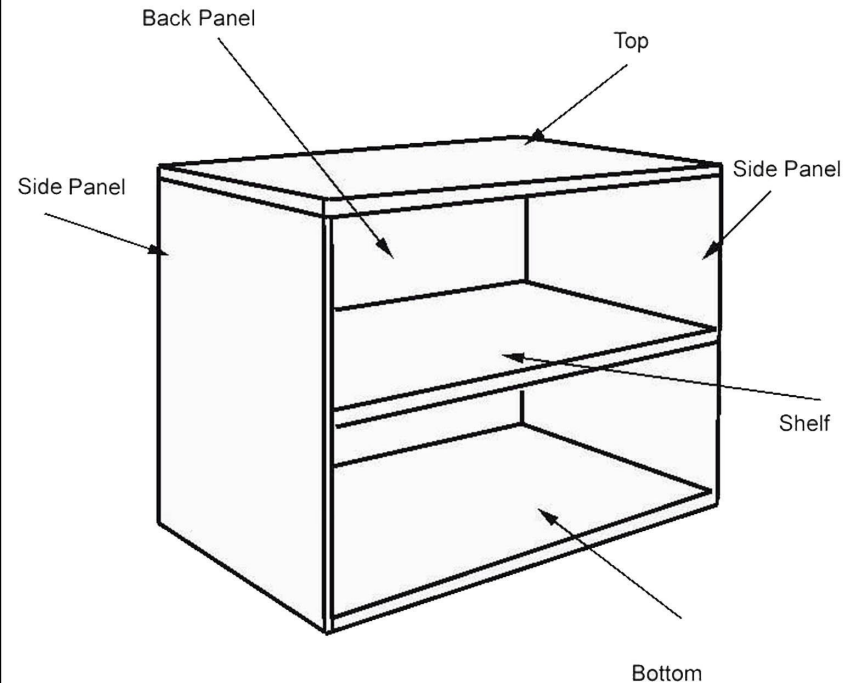
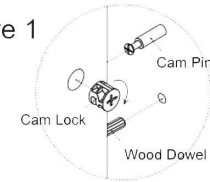

Questions? Please call 1-800-443-5117.

Customer Service available 8:30 - 5:00 Central Time, Monday - Friday

Y10406 - White Open Storage Unit Assembly Instructions

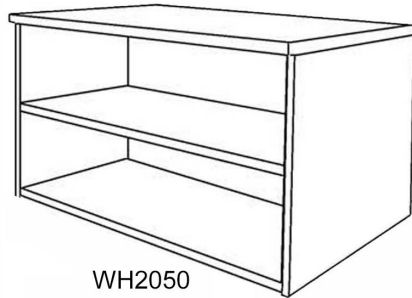

WH2050

PARTS LIST

Part	Part
 Wood Dowel	 Leveling Glide
 Cam Pin	 Shelf Pin
 Cam Lock	 Cap
	 Stickers

Tools Needed:
-Phillips Screwdriver
- A helper!

- 1.) Screw in all camlock pins and insert all wooden dowels in both SIDE PANELS, BACK PANEL, TOP and BOTTOM.
- 2.) Assemble the bookcase on its side. Begin by attaching the BOTTOM and one SIDE PANEL by placing it over the cam pins and inserting the cam locks. DO NOT YET TIGHTEN.
- 3.) Assemble the bookcase on its side. Begin by attaching the base with the trim piece by placing it over the cam pins and inserting the cam locks. DO NOT YET TIGHTEN.
- 4.) Connect BACK PANEL using same hardware method.
- 5.) Connect TOP and othe SIDE PANEL. When done, TIGHTEN ALL CAM LOCKS.
- 6.) Turn unit right side up and place in area of intended use. Insert shelf pins and SHELF where desired.
- 7.) Cover the cam locks with the caps provided.
- 8.) Use the stickers provided to cover any top surface pre-drilled holes, that won't be used to attach a hutch or desk frame.

Special Note:

Location & number of cam pin, cam lock and dowel holes may vary.

Figure 1

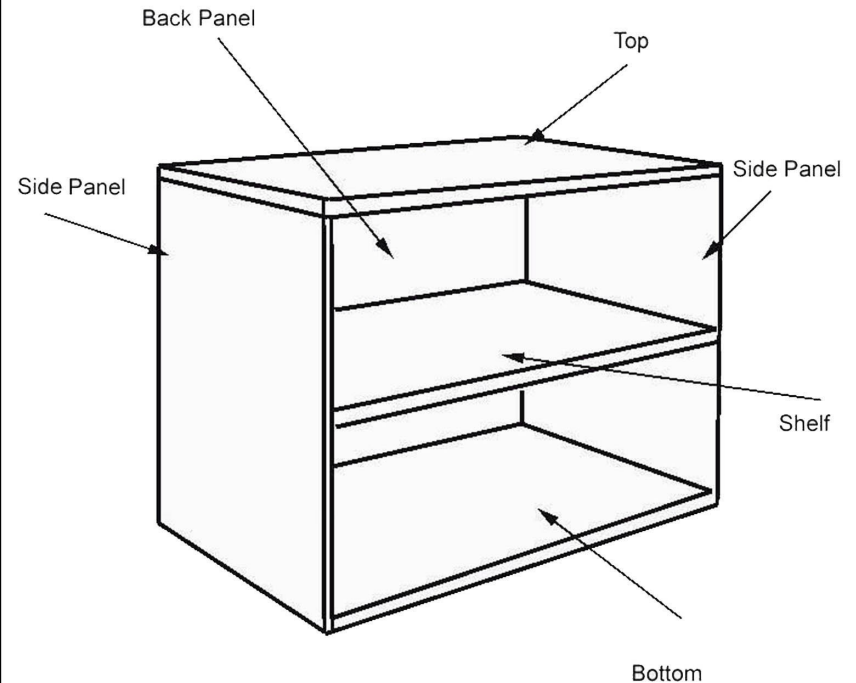
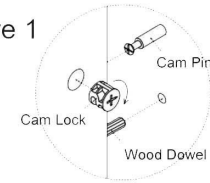

Questions? Please call 1-800-443-5117.

Customer Service available 8:30 - 5:00 Central Time, Monday - Friday

