

## Desk/Credenza Shell Assembly Instructions

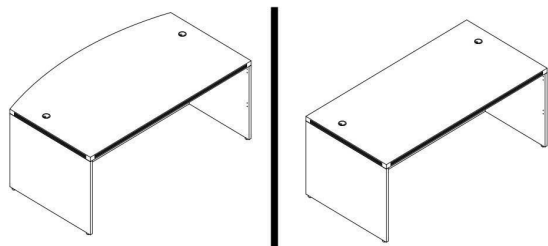

Applies to:

(BK/CH/MJ/ML/MWAL/WH) 2001/2002/2043/2089/3624/7124

### List of Hardware:

Part	Part
 Wood Dowel	 Cap
 Cam Pin	 Leveling Glide
 Cam Lock	 Grommet

### Tools Needed:

- Phillips Screwdriver
- A helper!

1.) Assemble on carpet or cardboard to protect parts during assembly. Assembly will require 2 people for safety.

2.) Locate left & right side panels. Screw in the leveling glides by hand. Then, insert wood dowels & cam pins. The wood dowels fit into the slightly larger holes, compared to the cam pin holes

3.) Locate front panel and insert all cam locks on the left & right sides. Then, align one of the side panels and connect the panel by inserting the cam pins into the cam locks and the dowels into the corresponding holes. (see diagram on next page). Twist the cam locks with a Phillips Screwdriver to secure.

### Special Note:

Location & number of cam pin, cam lock and dowel holes may vary.

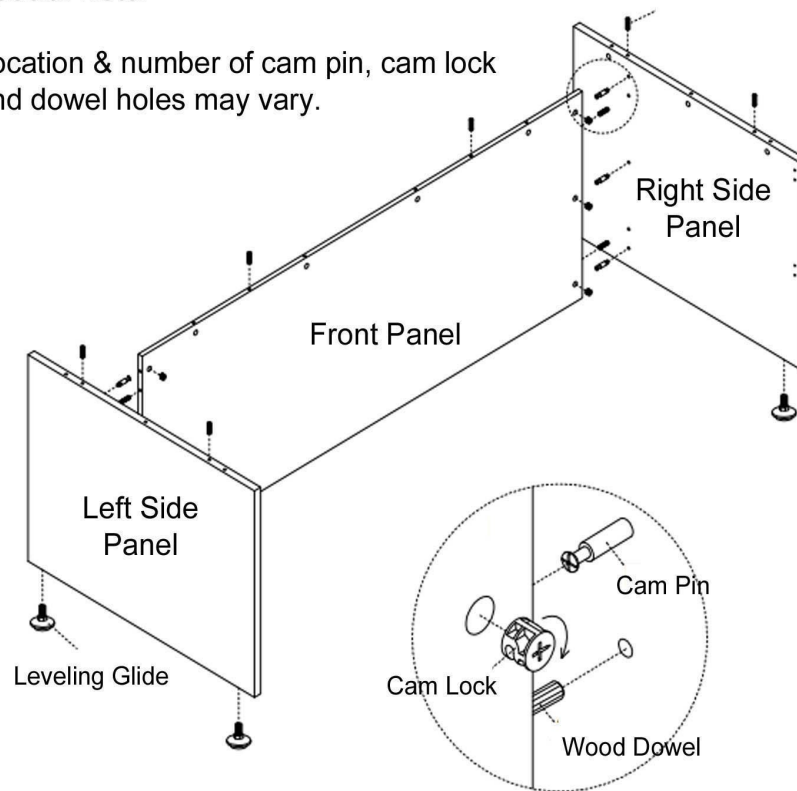

4.) Next, insert all cam pins, dowels and cam locks on the top edges of the side panels and front panels. Locate the desktop and with a helper, carefully set the desktop on top of the assembly shown above. Twist cam locks to secure the connection.

5.) Your last step is to insert the grommet(s) provided into the desktop. Cover the cam locks with the caps provided.

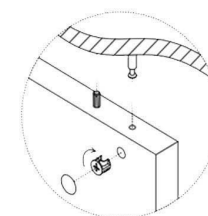
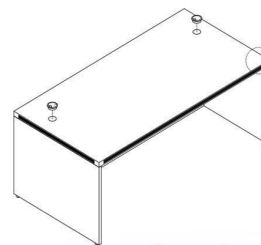

Questions? Please call 1-800-443-5117.





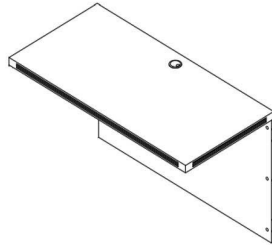





Customer Service available 8:30 - 5:00 Central Time, Monday - Friday

# Reversible Bridge Assembly Instructions



Applies to:  
BK/CH/FL/MJ/ML/WH2070

## List of Hardware:

Part	Part	Part
 Wood Dowel	 Shallow Cover	 Worksurface Bracket
 Cam Pin	 Deep Cover	 Side Panel Brackets (2)
 Cam Lock	 Grommet	 M6 Screw
 Wood Screw		 Leveling Glide

## Tools Needed:

- Phillips Screwdriver
- Power Screwdriver
- A Helper

- 1.) Assemble on carpet or cardboard to protect parts during assembly. Assembly will require 2 people for safety.
- 2.) Insert all wood dowels, cam pins and cam locks on the Desktop and Side Panel. Then, connect the two panels together by lining up the holes with the dowels & pins. Insert cam pins into holes that align with cam locks. Twist cam locks with a Phillips Screwdriver to secure the connection
- 3.) The next step is to attach the bridge between your desks. Locate the 2 Worksurface brackets (they may already be attached on the ends of the Desktop. If not, use the M6 Machine Screws to attach, centered over the edges of the Desktop like shown in drawing.)

## Special Note:

Location & number of cam pin, cam lock and dowel holes may vary.

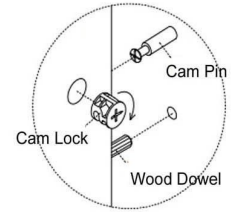

## Step 5: Offset Bracket

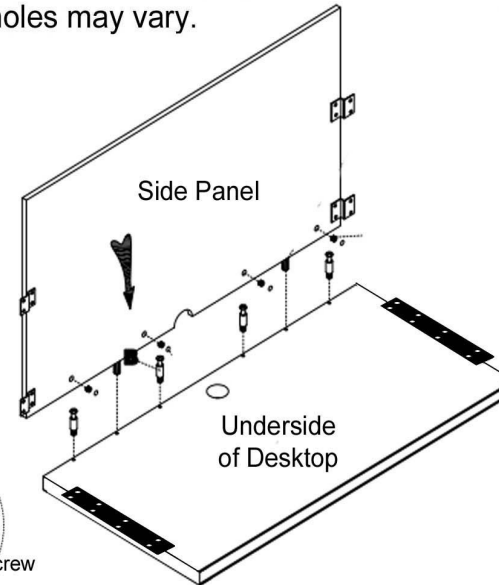
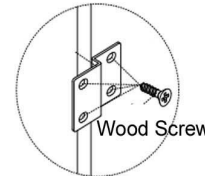

Left Hand Bridge

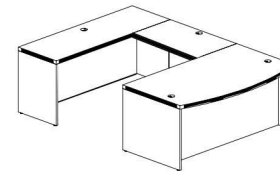

Right Hand Bridge

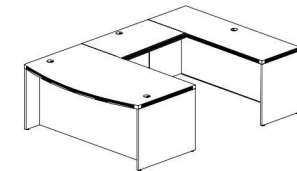

- 4.) Determine if the bridge will go on the left or right side of your desk. With a helper, have one person hold the bridge steady while the other person attaches the Worksurface Brackets to the undersides of the front desk & back credenza.
- 5.) Once installed & leveled, use the wood screws to install the offset side panel brackets. This will further secure the side panel, but is an optional step. A power screwdriver is helpful.
- 6.) Lastly, insert the grommet into the desktop and use the caps provided to cover the cam locks.

Questions? Please call 1-800-443-5117.



Customer Service available 8:30 - 5:00 Central Time, Monday - Friday

## Box/Box/File Desk Pedestal Assembly Instructions

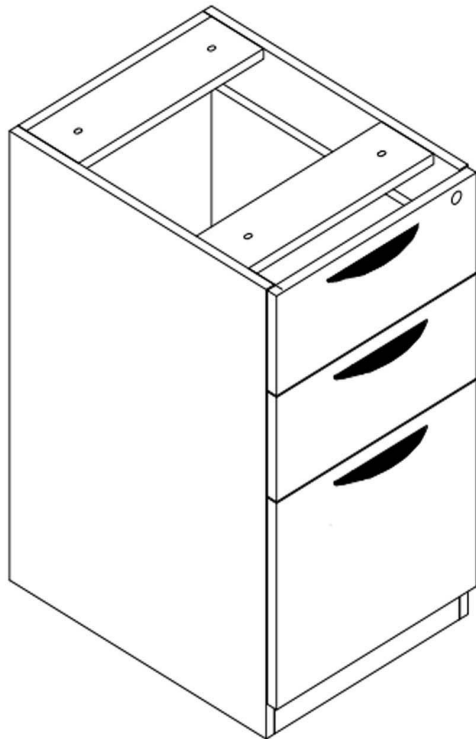
Applies towards:  
BK/CH/FL/MJ/ML/WH2066

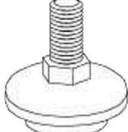

### List of Hardware:

Part	Part
 4 Large Bolts	 3 Drawer Pulls with screws
 1 set of keys	 4 Leveling Glides

- 1.) Install 4 leveling glides.
- 2.) Use the screws to attach drawer pulls.
- 3.) To install under desk, remove the top box drawer (or top two box drawers) by locating the black tabs inside of the left & right drawer slides. Push down on one and push up on the other. This will release the drawer from the slides. Use 4 large bolts to connect to threaded holes on underside of desk. Once done, simply insert drawers back into the slides. They will snap in place.