

# Industrial L-Desk Assembly Instructions

Questions: Call 1-800-443-5117, 8:30-5, Central Time, Mon-Fri

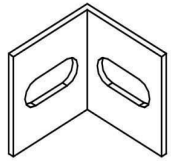

L-Bracket

Qty 18

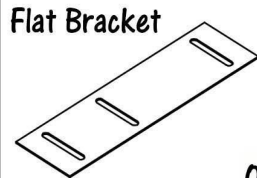

Flat Bracket

Qty 2

Qty 13

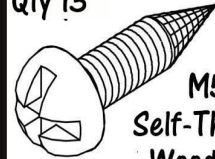

M5x20  
Self-Threading  
Wood Screw

Qty 8



M6x120  
Machine Bolt

Qty 41



M6x16 Machine Bolt

Tools You Will Need:

- Screwdriver
- Power Screwdriver
- A Helper

## Step 1

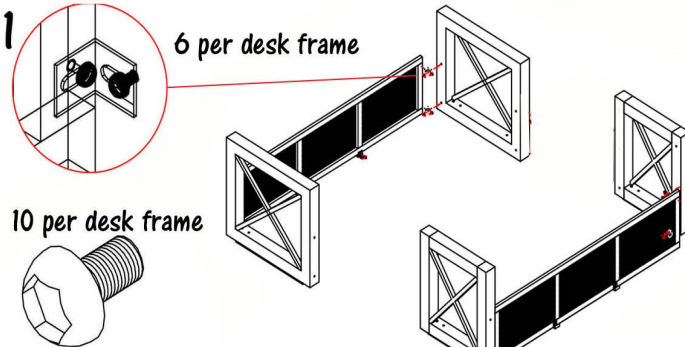

6 per desk frame

10 per desk frame

M6x16 Machine Bolt

Step 1) Assemble the front desk and the back desk (credenza) frames. Use the L-Brackets, M6x16 Machine Bolts and a Screwdriver. Assemble the frames upside down. Attach 5 L-Brackets to the Bridge Modesty Panel but don't attach the bridge modesty panel to the front or back desks just yet!

## Step 2

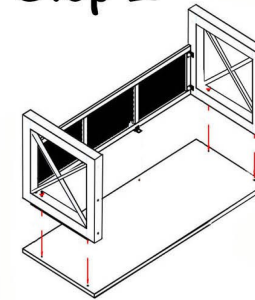

Step 2) Using the M6x120 machine bolts, attach the the worksurfaces to their respective desk frames.

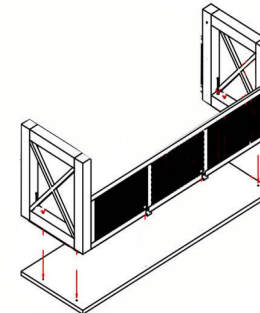

4 per desk frame



M6x120  
Machine Bolt

Qty 3



M5x20  
Self-Threading  
Wood Screw

## Step 3

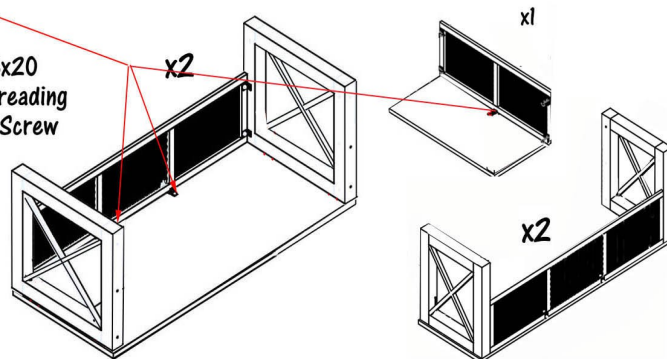

x2

x1

x2

Step 3). Using the M5x20 Self-Threading Wood Screws and a Power Screwdriver, attach the modesty panels to their respective worksurfaces. The screws are self-threading, so you will make your own holes.

## Step 4

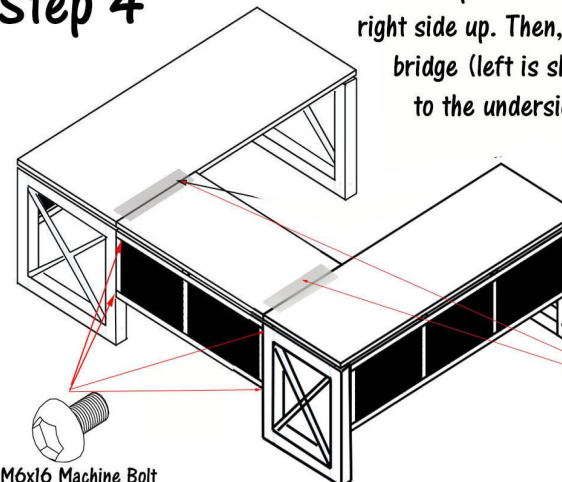

Step 4) With a helper, turn all desk sections over, right side up. Then, determine if you want a left or right bridge (left is shown below). Attach the Flat Brackets to the undersides of the front and back desks using the M6x16 Bolts. Then, attach the bridge modesty panel using M6x16 Bolts. Finally, attach the bridge desktop to the flat brackets using the same bolts.

Flat Bracket

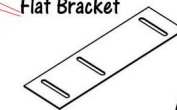

Qty 2

M6x16 Machine Bolt