

2-Door Cabinet Assembly Instructions

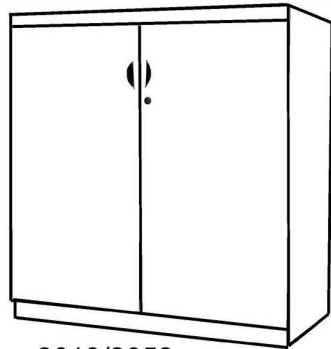

2013/2052

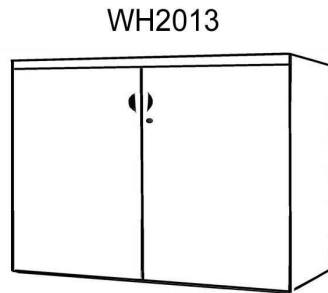

WH2013

Applies Towards:

FL/ML/MJ/WH2013











WH2013A

FL/ML/MJ2052

Tools Needed:

- Phillips Screwdriver
- A Helper

List of Hardware:

 Wood Dowel	 Shelf Pin	 Hinge
 Cam Pin	 Plunger Lock	 Hinge Plate
 Cam Lock	 Leveling Glide	 Lock/Key
 Door Pull	 Shallow Cover	 Deep Cover

Step 1.) For 2013 and 2052 cabinets only. Attach Toe Kick to Bottom Panel with cam pins & locks. Assemble upside down.

Step 2.) (For all cabinets) Attach Back Panel to Bottom Panel with cam pins & locks.

Step 3.) Attach Left & Right Side Panels in same manner.

Step 4.) Attach Top Surface with cam locks, cam pins and dowels. Then, insert the four leveling glides.

Step 5.) Insert shelf pins into holes along the interior sides. Place Shelf on top of the pins.

Step 6.) Attach four hinge plates with the screws included. The holes are piloted. **DO NOT TIGHTEN ALL OF THE WAY! LEAVE WIGGLE ROOM FOR ADJUSTMENT LATER ON.**

Special Note:

Location & number of cam pin, cam lock and dowel holes may vary.

Step 1

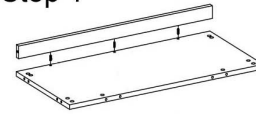

Step 3

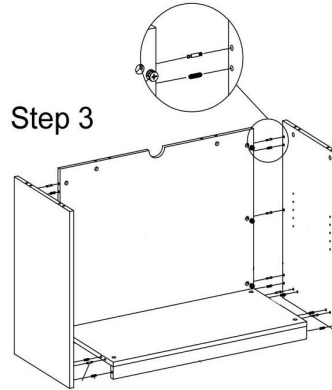

Step 5

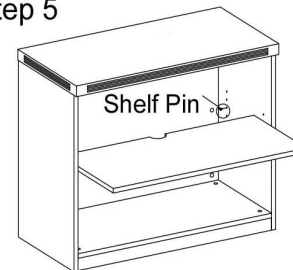

Step 2

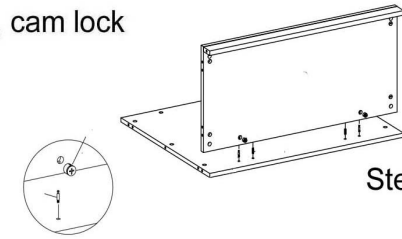

Step 4

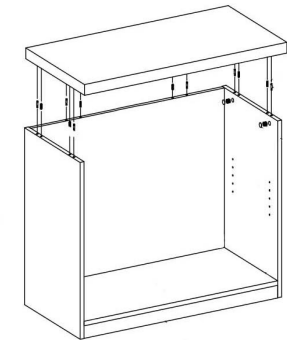

Hinge Adjustment

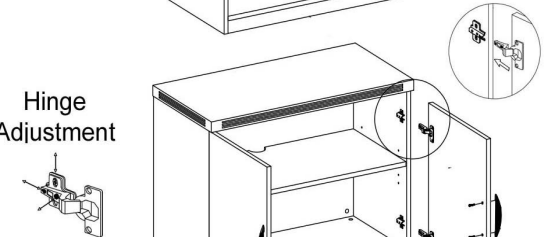

Steps 6-9

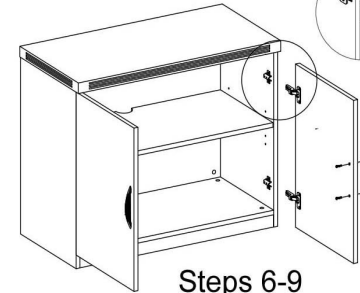

Step 7.) Attach two hinges per door. The holes are piloted. Then, insert the hinges into the hinge plates inside the cabinet. Connect with screws.

Step 8.) Attach the door pulls with the screws included. Insert shallow & deep covers over cam lock holes. Deep covers are for interior cams, shallow are for the back panel cams.

Step 9.) Once you have the cabinet in the place you intend to use it, it will be time to adjust the hinges to align the doors. Using your screwdriver, turn the set screw on the hinge to adjust the depth and the screws on the hinge plate to move the door up/down. See diagram above.

Step 10.) Your last step is to insert the shallow & deep covers over the cam locks and to attach the plunger lock and lock core. Locate the pre-drilled notch on the underside of the Top Surface. Attach plunger lock so it inserts into the notch when pushed in. Attach the lock core with four screws provided.

Questions? Please call 1-800-443-5117.

Customer Service available 8:30 - 5:00 Central Time, Monday - Friday

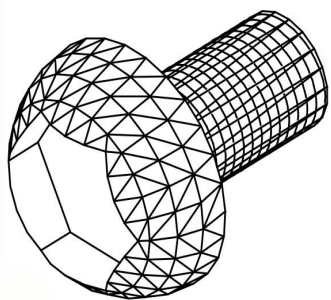

M16 Machine Bolts
Qty 20



36"W Metal Hutch Assembly Instructions

Questions: Call 1-800-443-5117, 8:30-5, Central Time, Mon-Fri

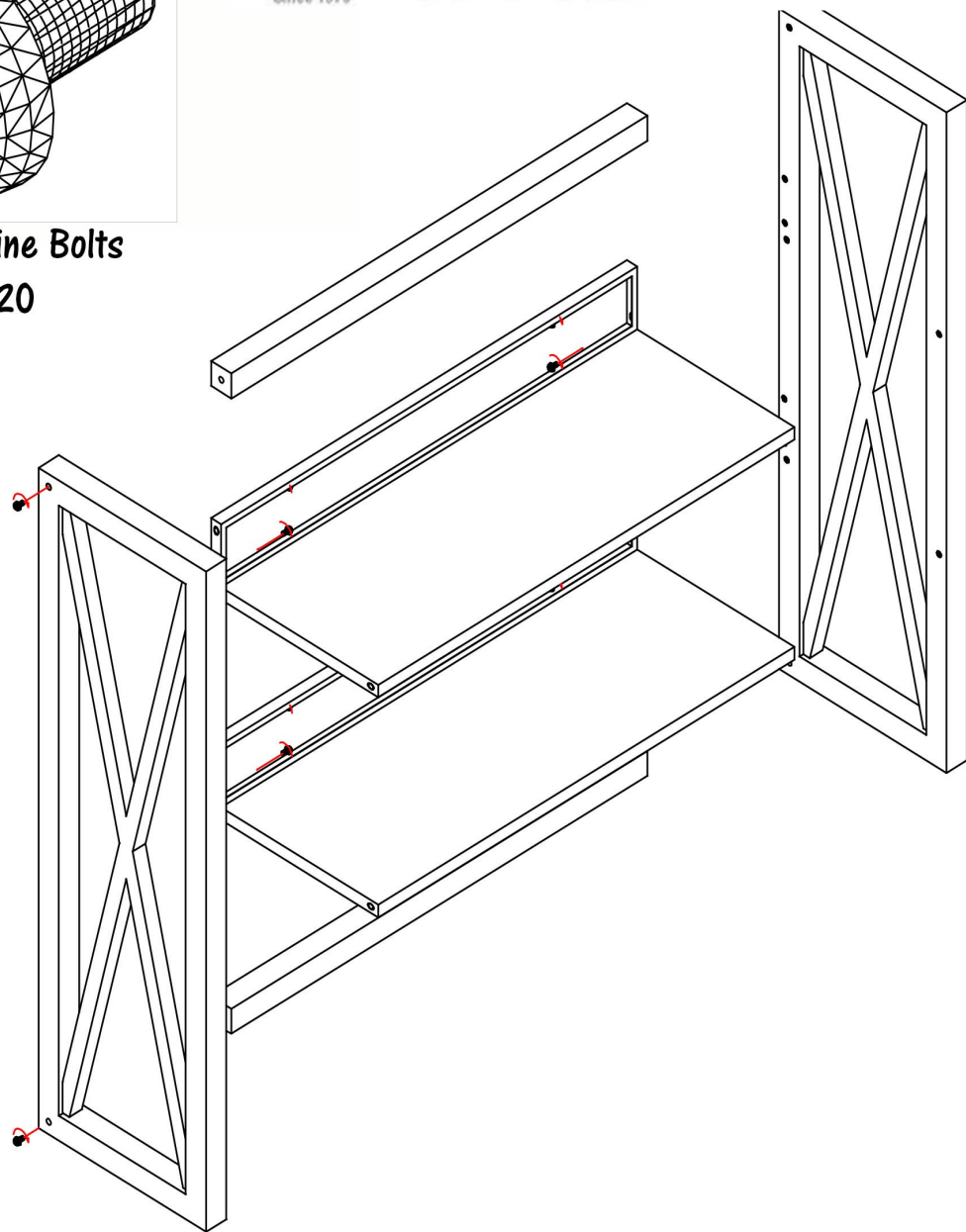

Step 1) Assemble on carpet or cardboard to protect during assembly.

Step 2) Start with one Side Frame and attach all shelves and cross beams, starting with the bottom cross beam and assembling the shelves and other beams from there. Use the M16 Bolts and Allen Wrench Included.

Step 3) Attach the other Side Panel using same hardware.

Step 4) Optional: Double Sided Tape is pre-applied to the bottom of the side panels. To secure to your surface, peel off the back and carefully place the hutch onto the surface.

