

## Oval Racetrack Conference Table Assembly Instructions

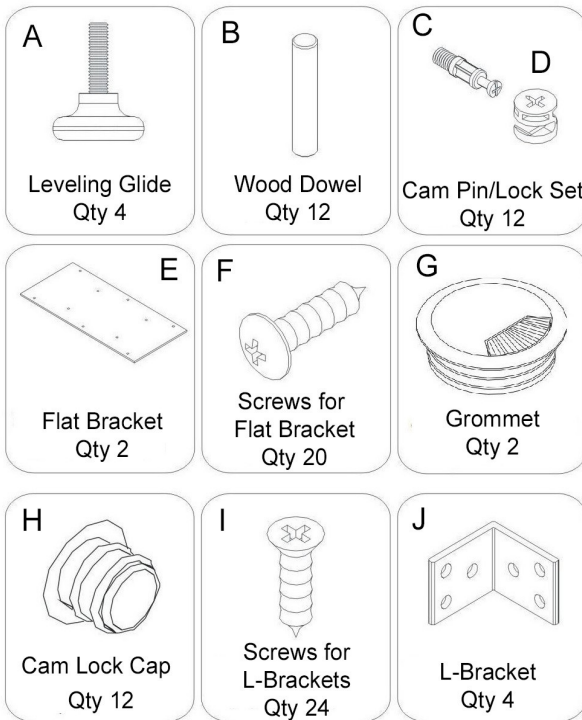
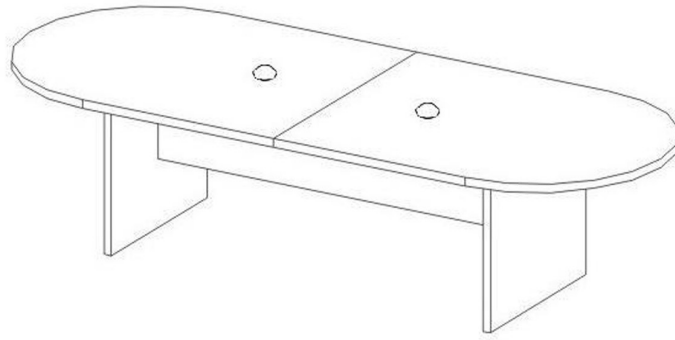

**Tools Needed:**  
 -Power Screwdriver/Drill  
 -Phillips Screwdriver  
 -A Helper

**Tips:**  
 - Assemble upside down on carpet or cardboard for protection.

- Assemble in area of planned use to minimize moving.

- Use multiple people to help turn over in last step, supporting the bases.

Figure 1

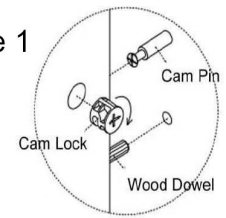

Step 1) Lay the table tops face down on the carpet. Attach (E) Brackets with (F) Wood Screws using a Power Screwdriver.

Step 2) Next, you will need to assemble the bases and support panel separately. Start by inserting all of the hardware into the bases and cross beam (A), (B), (C) and (D) hardware.

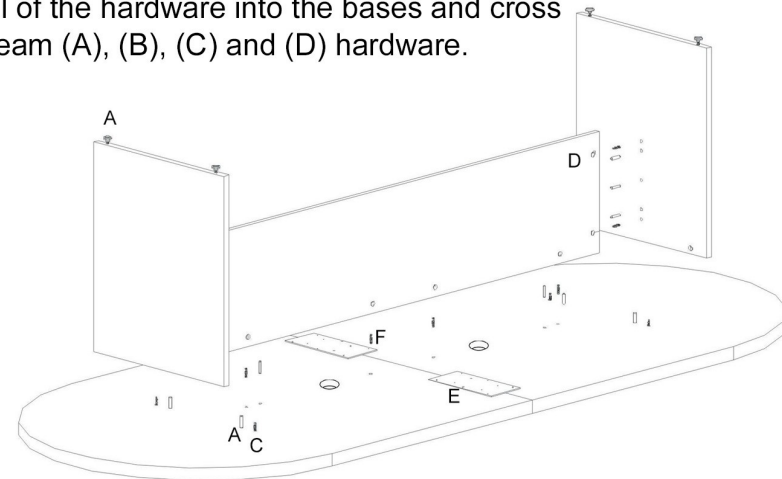

Step 3) Attach both of the bases to the support panel and secure the (C) Cam Pins and (D) Locks with a Phillips Screwdriver like in Figure 1 shown above.

Step 4) Insert all (B) Dowels and (C) Cam Pins into the table top for the bases and support panels.

Step 5) With a helper, lift the bases and support panel and set on top of the tables tops, securing the (D) Cam Locks as shown in Figure 1.

Step 6) Attach (J) L-Brackets using (I) Screws to the underside of the table top, to the bases for extra reinforcement.











Step 7). With a helper, carefully turn table upright.

Step 8) Insert (H) Caps and (G) Grommet Covers.

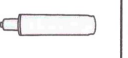
Questions? Please call 1-800-443-5117.

Customer Service available 8:30 - 5:00 Central Time, Monday - Friday

**Parts:**

(1)×1 	(2)×1 	(3)×1(-L)/(-R) 	(4)×1 	(5)×1(-L)/(-R) 	(6)×1 	(7)×1 
(8)×5 	(9)×4 	(10)×6 	(11)×2 	(12)×2 	(13)×1 