

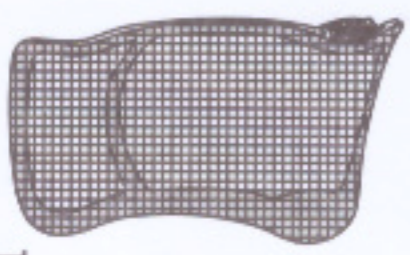

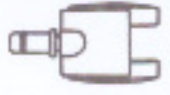



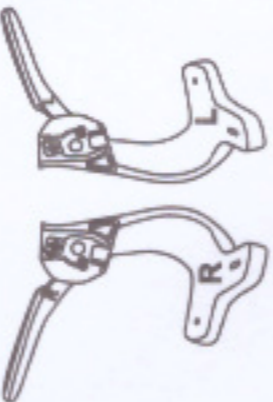

# Y14022 - Mesh Ergonomic Office Chair Assembly Instructions

(1) X1		(6) X5	
(2) X1		(7) X1	
(3) X1 (L) X1 (R)		(8) X8	
(4) X1		(9) X4	
(5) X1		(10) X1	

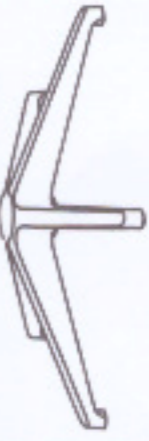

www.modernofficefurniture.com

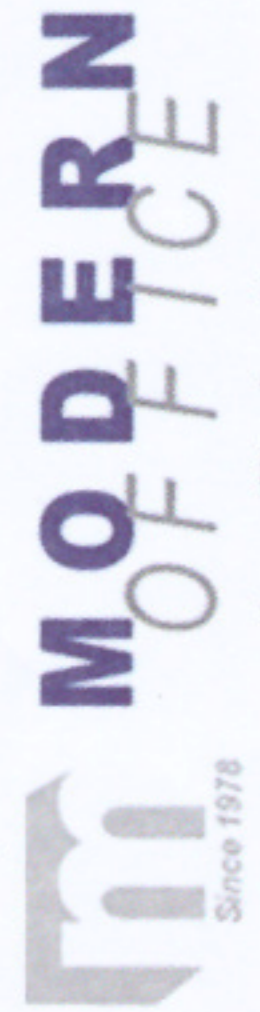
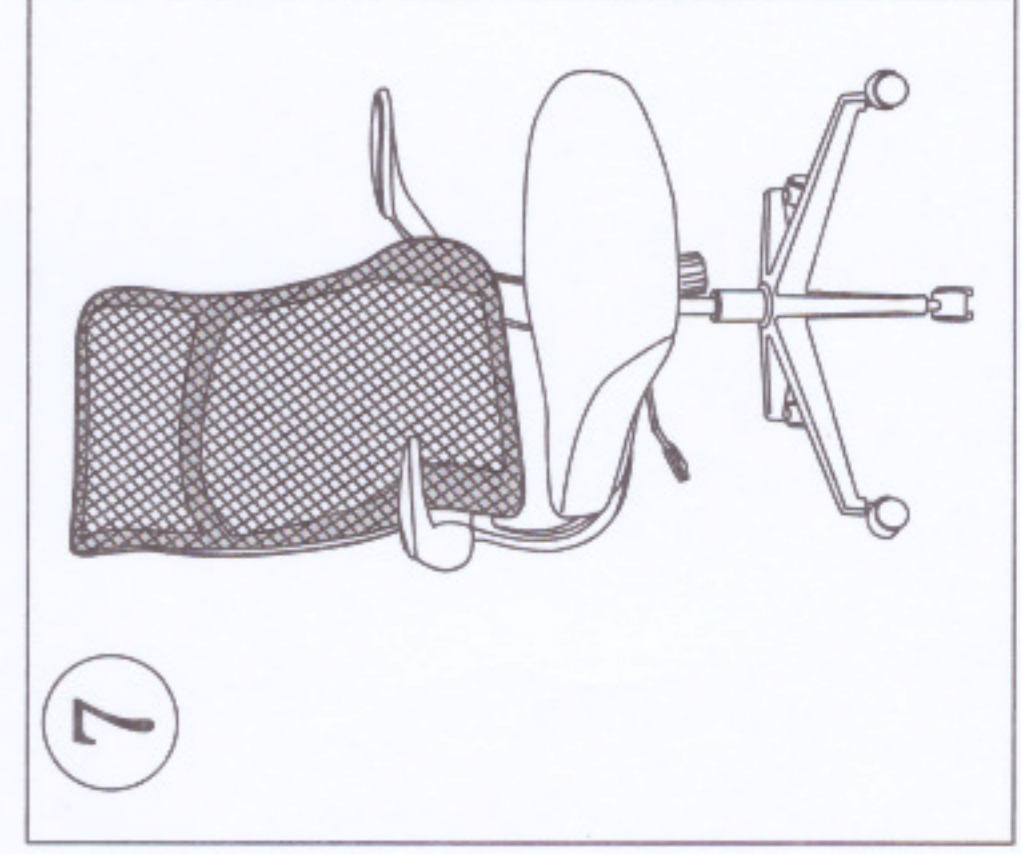
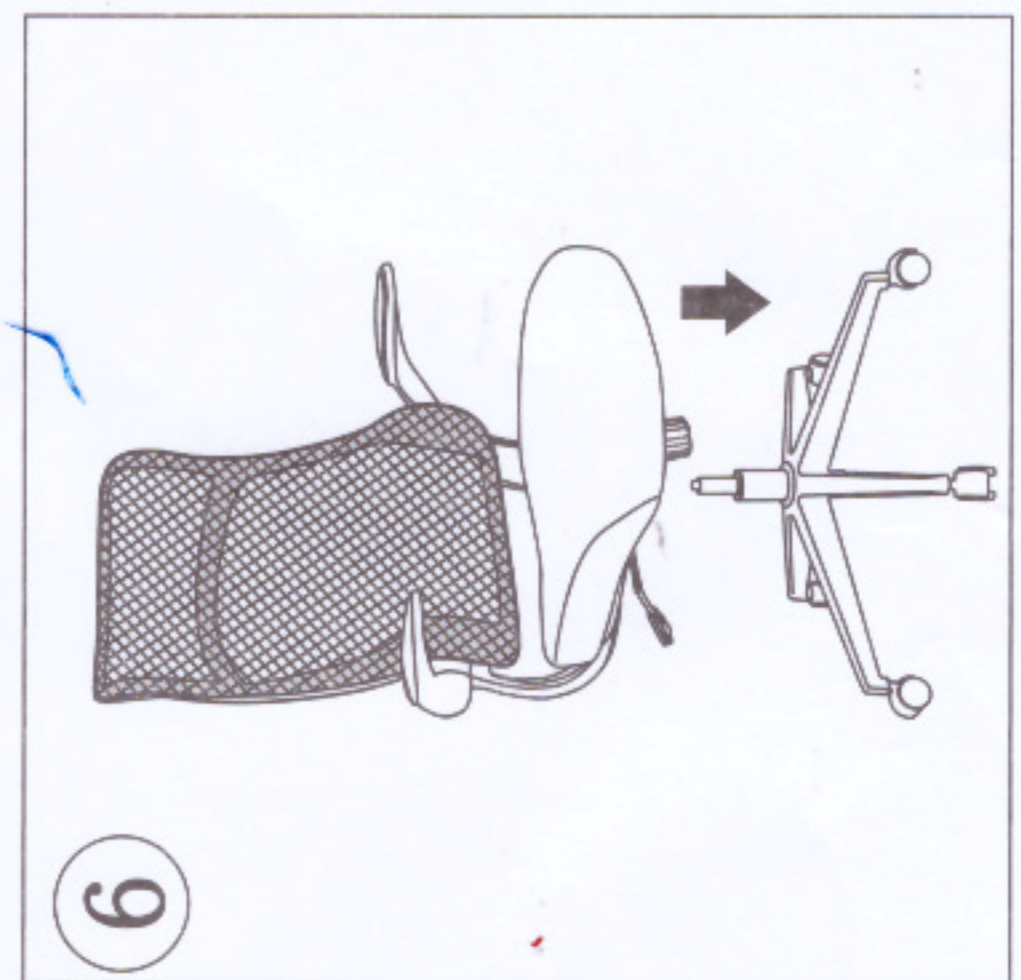
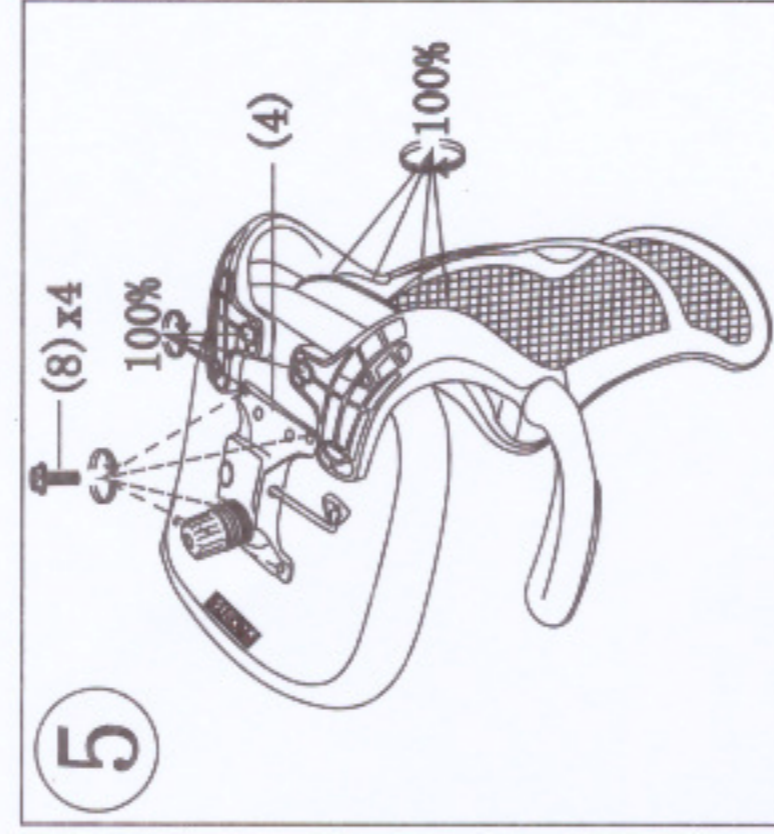
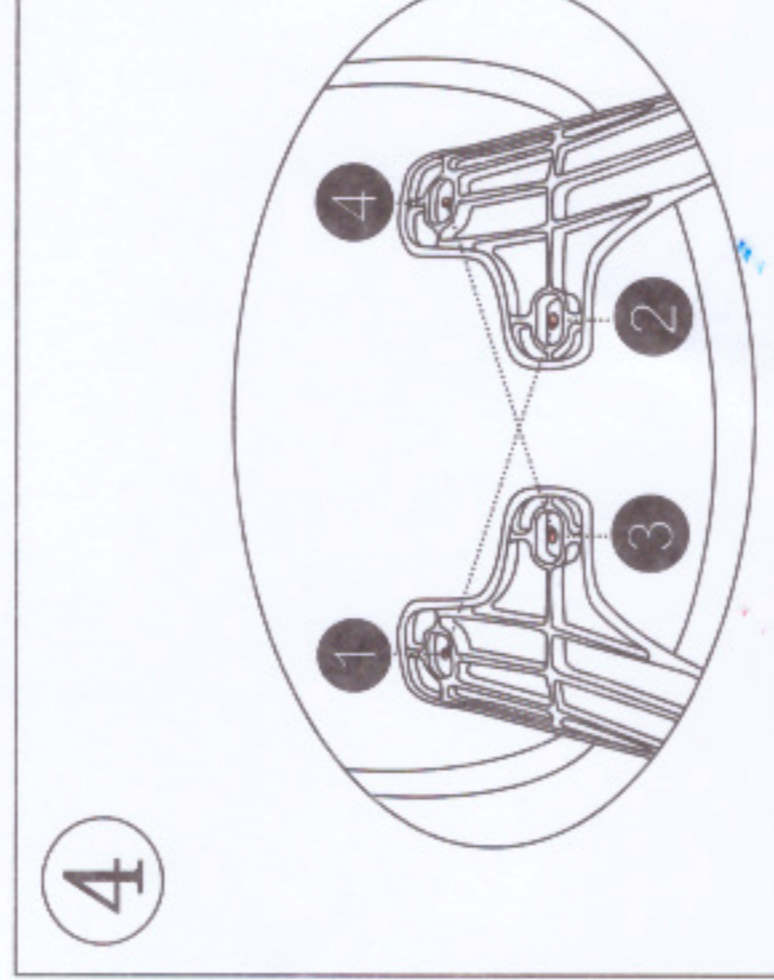
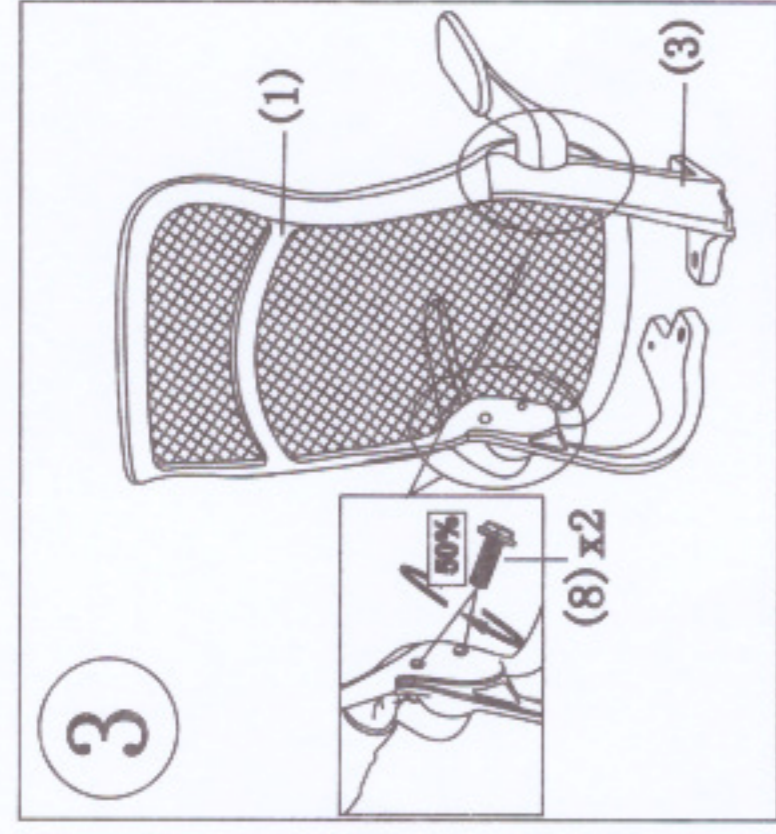
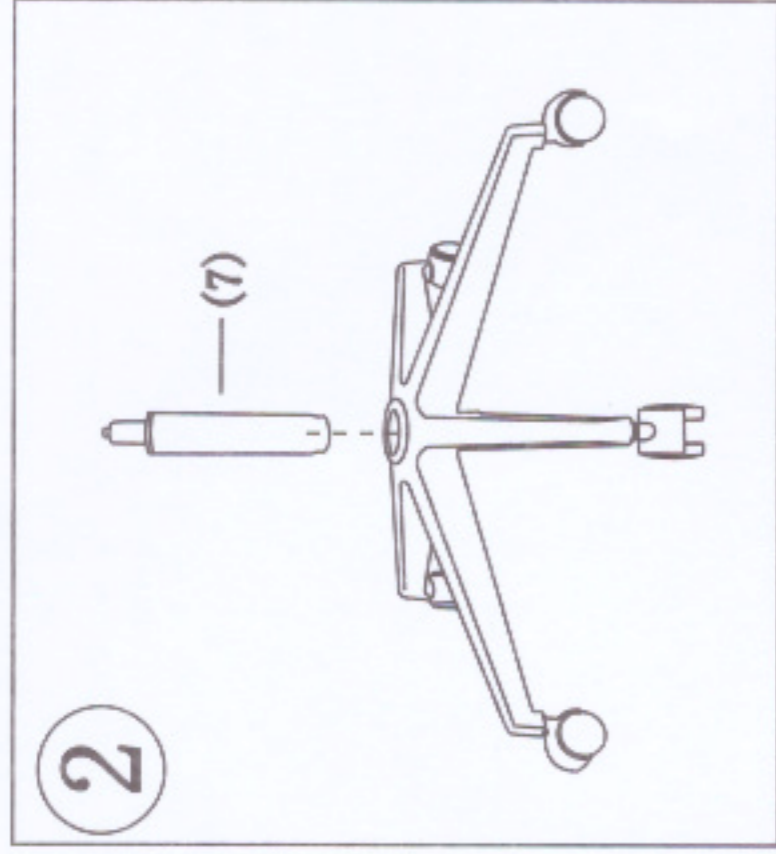
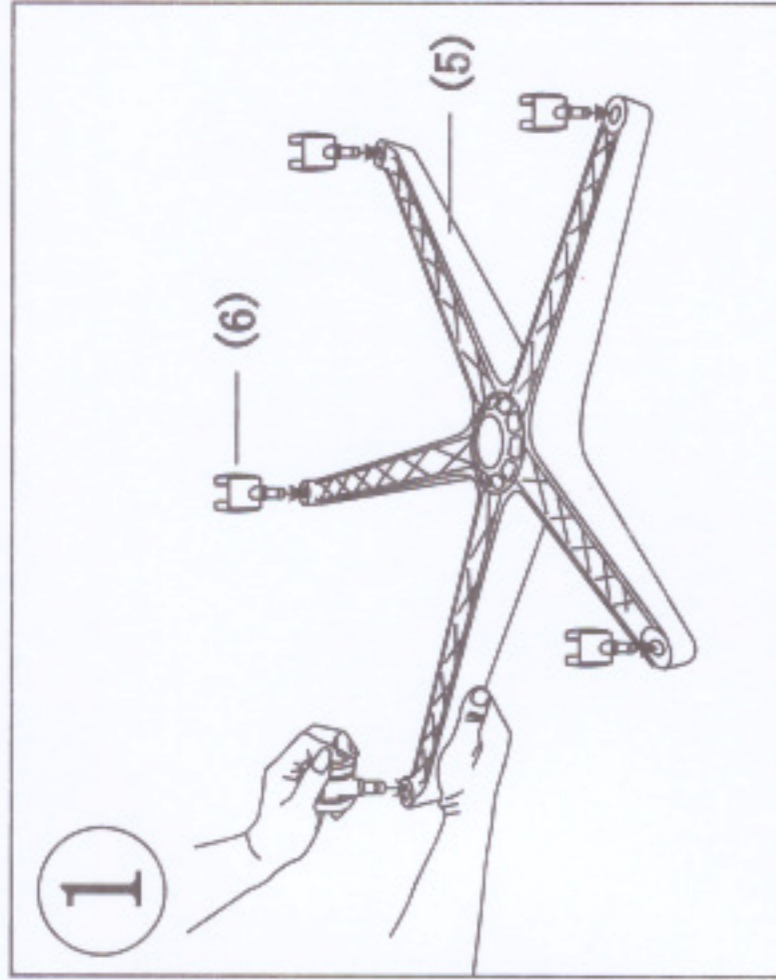
Questions? Please call 1-800-443-5117.

Customer Service available 8:30 - 5:00 Central Time, Monday - Friday