













Assemble on cardboard or carpet for protection during assembly. 2-person assembly team suggested.

COMPONENTS

1  MX2 RCT2412 A 2 Pcs	2  MX ML1200 2 PCS	3  MX MB1120 4 Pcs	4  MX2 CBCT 1 Pc
--	--	--	--

HARDWARE

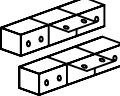
A  #6 x 16mm P/H Cross Recessed Screw 8 Pcs	B  CSK 3.5 X 16 8 Pcs	C  JCBC M6 X 50 8 Pcs	D  L-KEY 1PC	E  JCBC M6 X 50 6 Pcs	F  JCBC M6 X 35 4 Pcs	G  FLAT WASHER 1/4 4 Pcs	H  L-KEY 1 Pcs	I  BEAM CONNECTOR 2 Pcs
---	---	---	--	---	--	--	--	---

PACKED WITH MX ML1200

PACKED WITH MX MB1120

PACKED WITH MX2 CBCT

STEP 1:

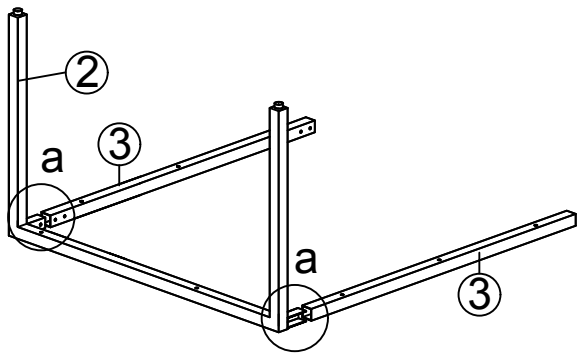

STEP 2:

DO NOT TIGHTEN

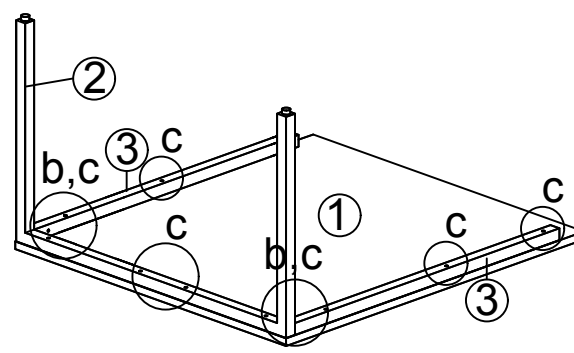

STEP 3:

TIGHTEN AFTER FITTING TABLE TOP

