

1

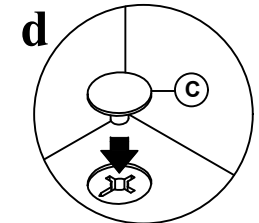

2

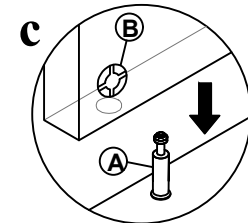
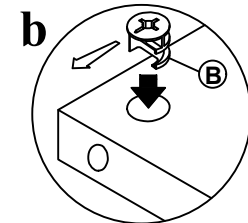
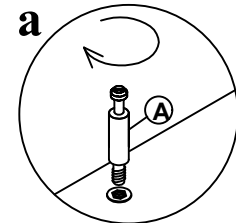
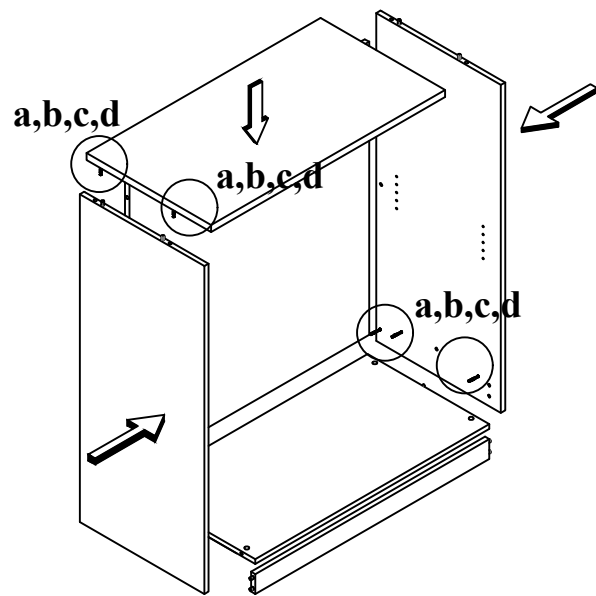
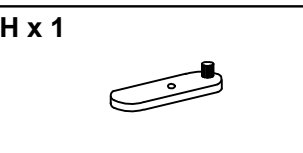
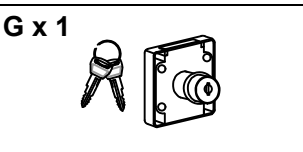
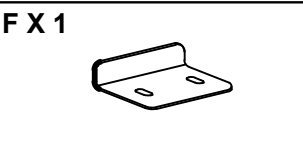
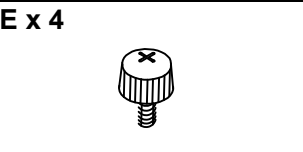
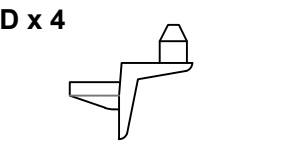
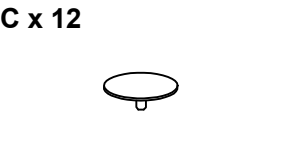
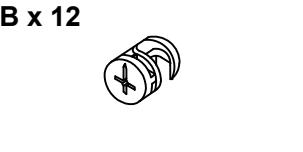
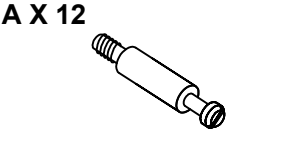
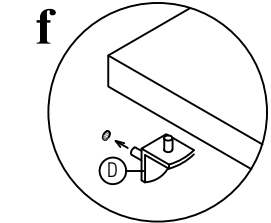
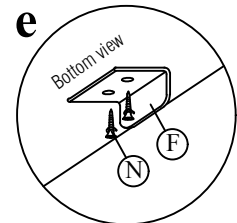
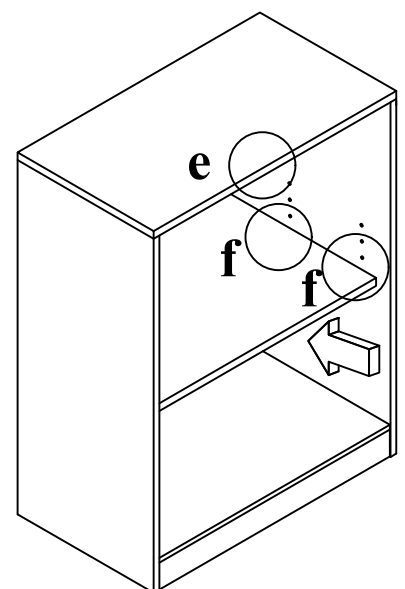

I x 4



3

J x 2

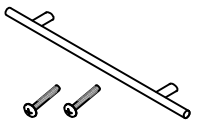

K x 4

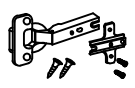

L x 4 (M3.5 x 18mm)



M x 9 (M3.5 x 16mm)



N x 2 (M3.5 x 12mm)



O x 1

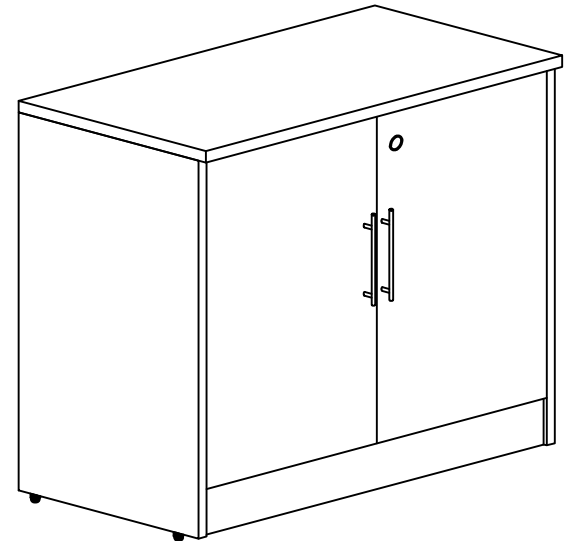
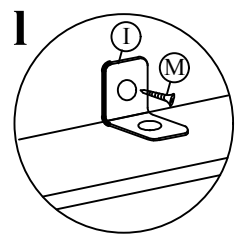
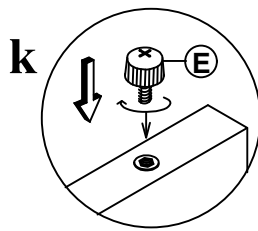
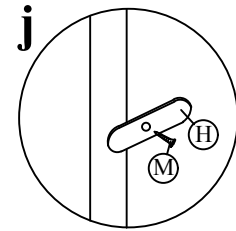
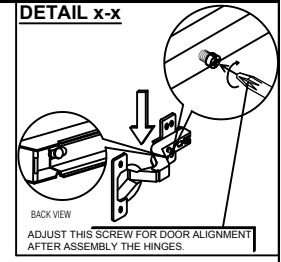
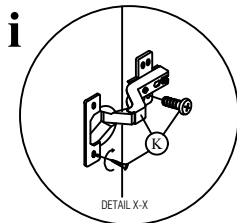
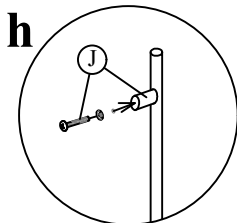
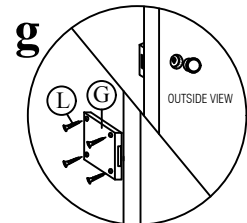
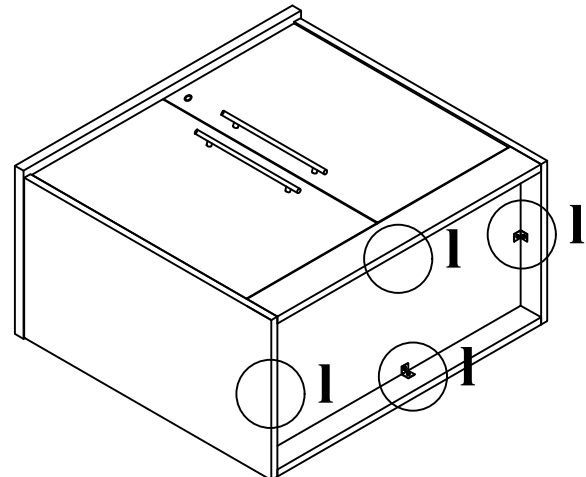
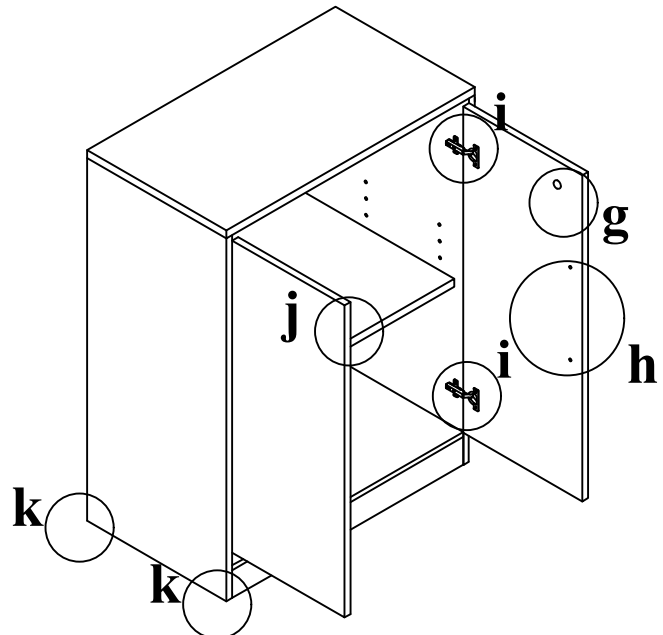

MVP OH

A x 10

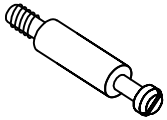

B x 10



C x 10



D x 8

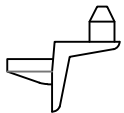

E x 1



1

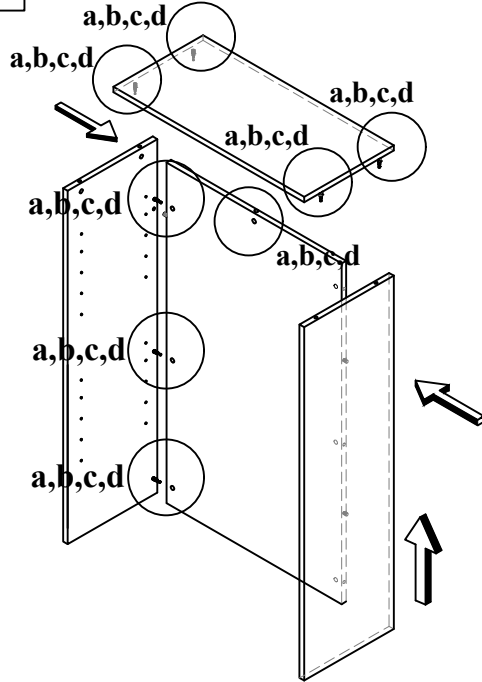

a

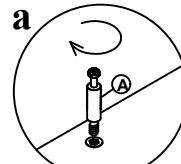

b

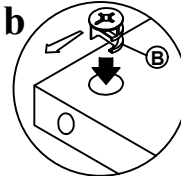

c

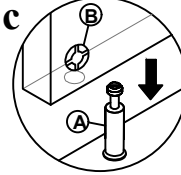

d

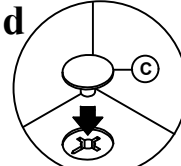

2

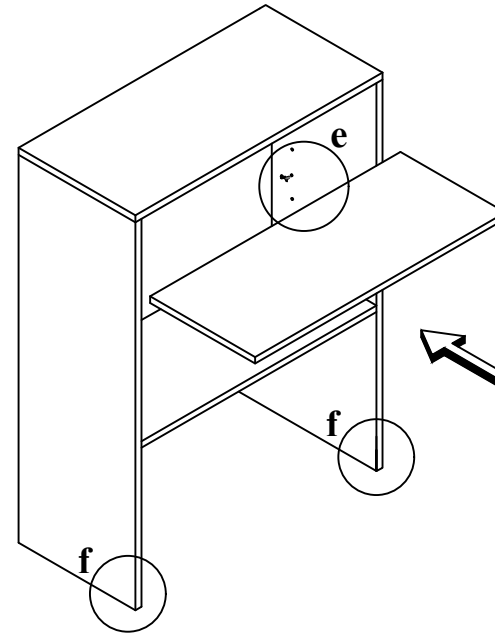

e

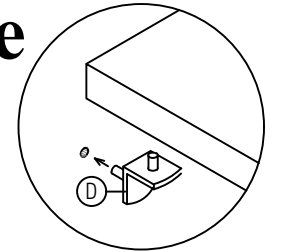

f

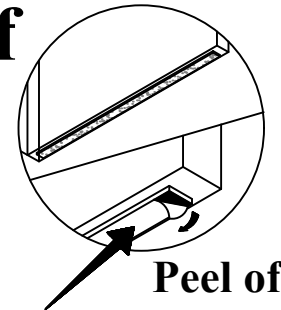

Peel off

