

# Flip Top Training Table Assembly Instructions

Table Base Assembly Diagram

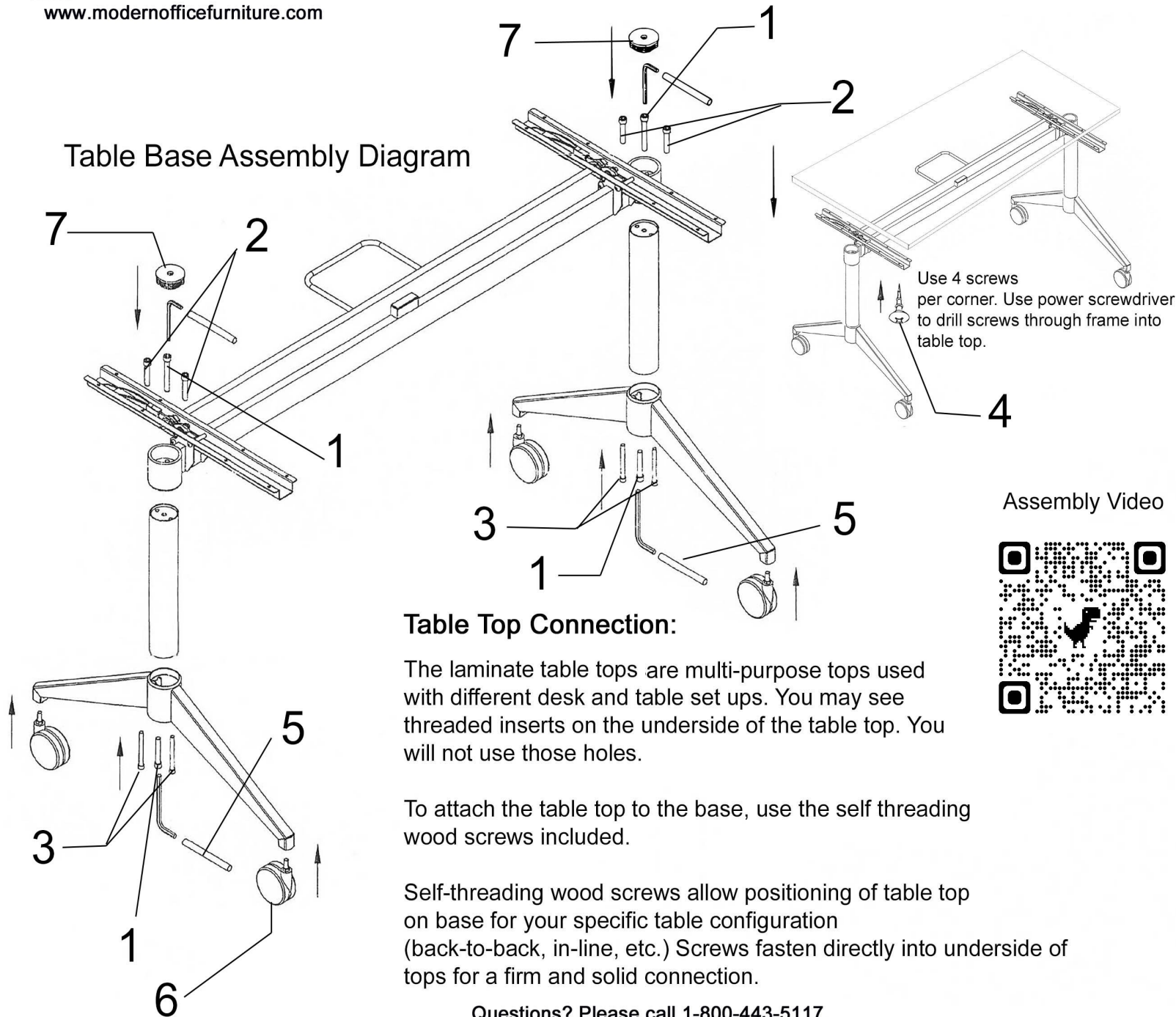

## Table Top Connection:







The laminate table tops are multi-purpose tops used with different desk and table set ups. You may see threaded inserts on the underside of the table top. You will not use those holes.

To attach the table top to the base, use the self threading wood screws included.

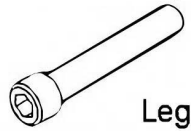
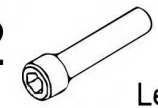
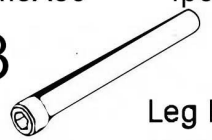
Self-threading wood screws allow positioning of table top on base for your specific table configuration (back-to-back, in-line, etc.) Screws fasten directly into underside of tops for a firm and solid connection.

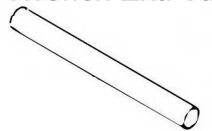
Questions? Please call 1-800-443-5117.

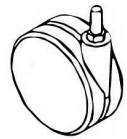
Customer Service available 8:30 - 5:00 Central Time, Monday - Friday

M10x60	4pcs	<b>#1</b>		Leg Bolt
M8x50	4pcs	<b>#2</b>		Leg Bolt
M8X80	4pcs	<b>#3</b>		Leg Bolt
Wood Screws	16 pcs	<b>#4</b>		
Allen Wrench Ext. Tube		<b>#5</b>		1 pc
M10 Allen Wrench M8 Allen Wrench				1 pc ea.
Caster	4 pcs	<b>#6</b>		
Cap	2 pcs	<b>#7</b>		

Assembly Video

