



WorkTrend Conference Table / Desk

WORK3672-WHITE/CHAR/MAPLE/MOCHA/MWAL/CHERRY
NTTWORKLEG



Included Hardware:

| Part |
|------------------------------------------------------------------------------------------------------------------------------------------|
| <p>Qty 16</p>  <p>Machine Screw</p> |
|  <p>Double-Sided Tape (for workstations only)</p> |

Tools Needed:

-Phillips Screwdriver or
Power Screwdriver

- 2 people

Close up of Leg attachment

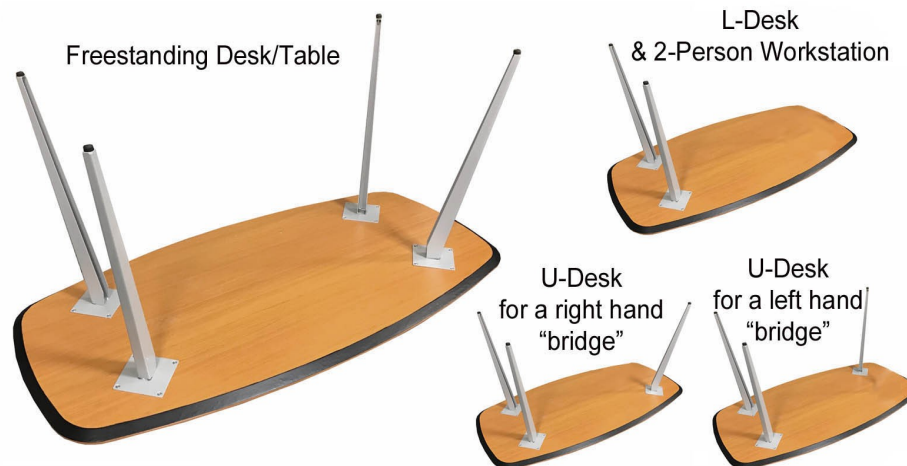

1.) Set Table Top upside down on carpeted surface or on cardboard box for protection during assembly.

2.) Attach Angled Legs with Machine Screws provided, 4 per Leg. If assembling an L-Desk or 2-Person Shared Desk, only two Legs are included. If assembling a U-Desk, 3 Legs are included. 4 Legs are included with the Freestanding Desk/Table.

If assembling an L-Shaped Desk, U-Shaped Desk or 2-Person Shared Desk, skip Steps 3 & 4 and go directly to Step 5.

3.) With a helper, carefully turn the table upright. **DO NOT DRAG TABLE!** Lift table with a helper to put in position.

4.) Table can be leveled with built-in leveling glides on legs, if needed.

Questions? Please call 1-800-443-5117.

Customer Service available 8:30 - 5:00 Central Time, Monday - Friday

Follow the steps below once the workstation shell has been assembled and is in position:

5.) See the diagrams below to guide you on how to place your Desk Top on your workstation.

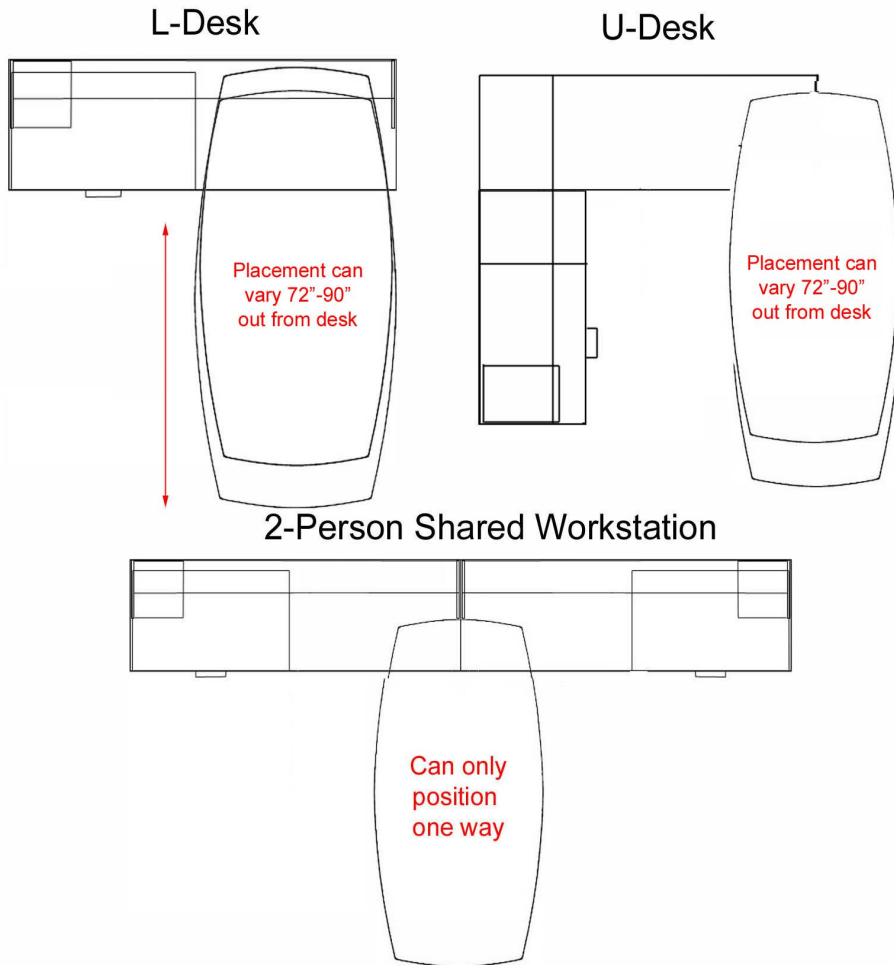

6.) Placement:

For L-Desks and 2-Person Workstations, Set the open end of the Desk Top on the Workstation Shell and determine how far out you would like desk to extend outward. This can extend a total of 75" to 90" from the back of the Workstation Shell. Use two people for positioning of top.

For U-Desks, rest the open corner of the Desk Top upon the Workstation Shell. This can be positioned as desired, but for an even appearance the outer edge of the Desk Top should align with the back edge of the Workstation Shell. Then, carefully position so the Desk Top is parallel to the rear return section of the U-Shaped Workstation. Use two people for positioning of top.

7.) Adjust the leveling glides so that the Desk Top sits completely flat on the adjoining desks.

8.) Once you have determined your ideal position, using the 2-sided foam adhesive provided, attach two full length strips of tape to the Workstation Shell surface. Press Desk Top down and within approximately 24 hours this will form a permanent bond.

Questions? Please call 1-800-443-5117.

Customer Service available 8:30 - 5:00 Central Time, Monday - Friday

Desk/Credenza Shell Assembly Instructions

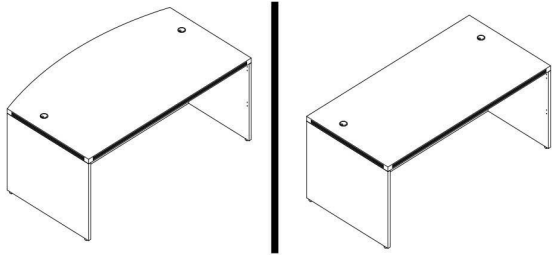

Applies to:

(BK/CH/FL/MJ/ML/WH) 2001/2002/2043/2089/3624/7124

List of Hardware:

| Part | Part |
|-------------------------------------------------------------------------------------------------|-------------------------------------------------------------------------------------------------------|
|  Wood Dowel |  Cap |
|  Cam Pin |  Leveling Glide |
|  Cam Lock |  Grommet |

Tools Needed:

- Phillips Screwdriver
- A helper!

1.) Assemble on carpet or cardboard to protect parts during assembly. Assembly will require 2 people for safety.

2.) Locate left & right side panels. Screw in the leveling glides by hand. Then, insert wood dowels & cam pins. The wood dowels fit into the slightly larger holes, compared to the cam pin holes

3.) Locate front panel and insert all cam locks on the left & right sides. Then, align one of the side panels and connect the panel by inserting the cam pins into the cam locks and the dowels into the corresponding holes. (see diagram on next page). Twist the cam locks with a Phillips Screwdriver to secure.

Special Note:

Location & number of cam pin, cam lock and dowel holes may vary.

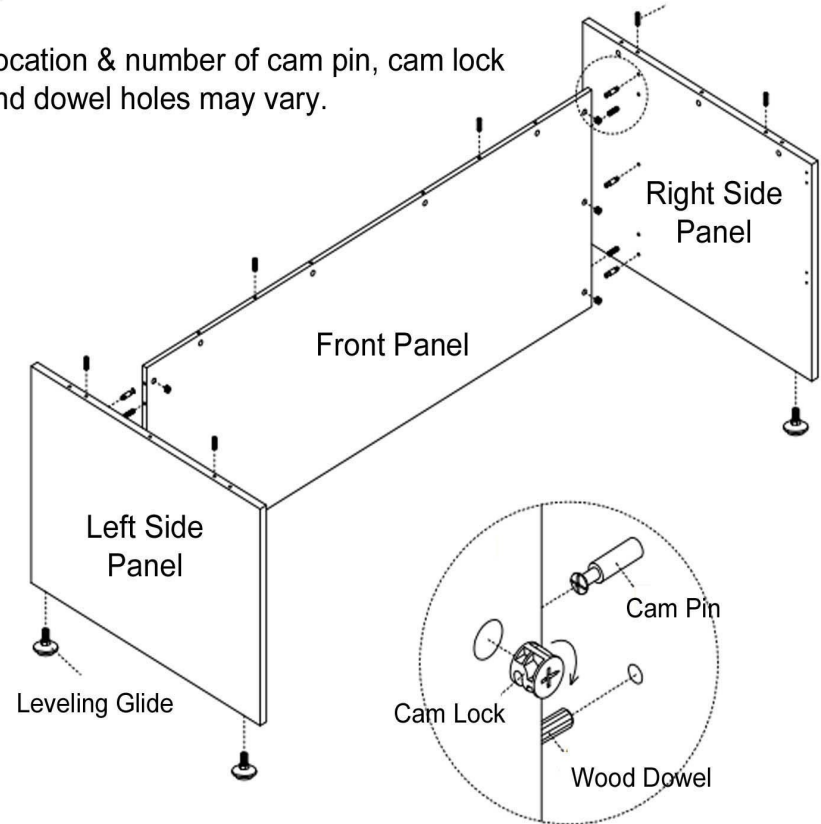

4.) Next, insert all cam pins, dowels and cam locks on the top edges of the side panels and front panels. Locate the desktop and with a helper, carefully set the desktop on top of the assembly shown above. Twist cam locks to secure the connection.

5.) Your last step is to insert the grommet(s) provided into the desktop. Cover the cam locks with the caps provided.

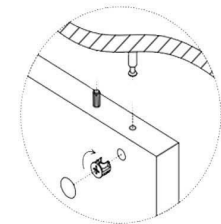
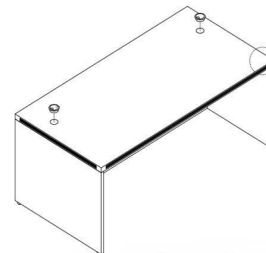

Questions? Please call 1-800-443-5117.

Customer Service available 8:30 - 5:00 Central Time, Monday - Friday



2, 3 & 4 Drawer Lateral File Assembly Instructions

Applies towards:

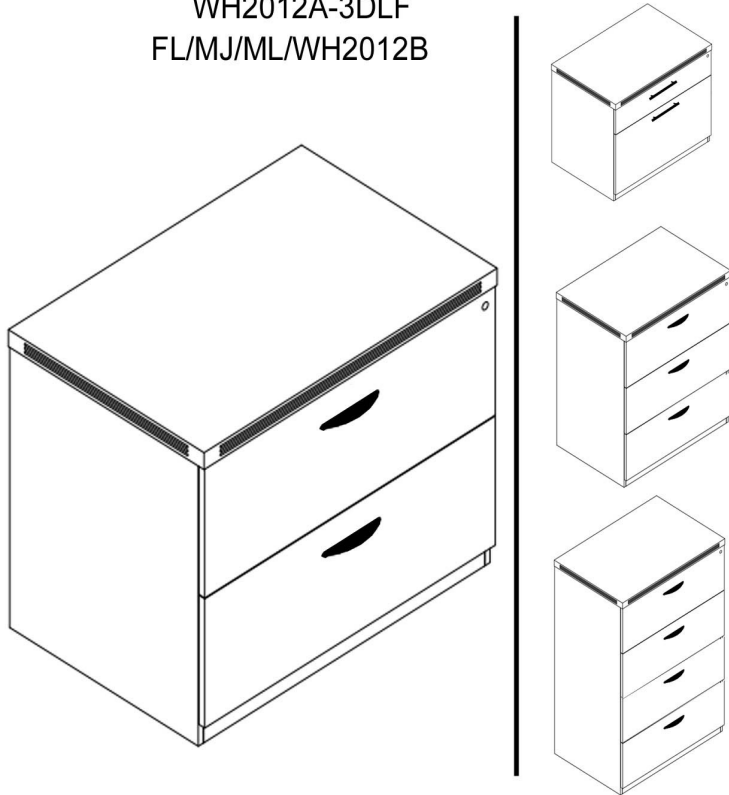
BK/FL/MJ/ML/WH2012
WH2012A
LF3622-MWAL
LF3622-WH
WH2012A-3DLF
FL/MJ/ML/WH2012B

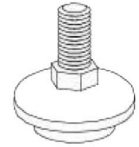

List of Hardware:

| Part | Part |
|---------------------------------------------------------------------------------------------------------------------------------------|----------------------------------------------------------------------------------------------------------------------------|
| <p>Drawer Pull Screw</p>  <p>2 per drawer pull</p> | <p>Drawer Pull</p>  <p>1 per drawer</p> |
|  <p>1 set of keys</p> |  <p>4 Leveling Glides</p> |

1.) Install 4 leveling glides. Keep the front two leveling glides 1/4" taller than the back back two, which means your file will be slightly tilted back. This is the proper way to level a lateral file cabinet. It keeps any unlocked file drawers from creeping open and distributes the weight more evenly.

2.) Use the screws to attach drawer pulls.

Questions? Please call 1-800-443-5117.

Customer Service available 8:30 - 5:00 Central Time, Monday - Friday

White Storage Cube Assembly Instructions

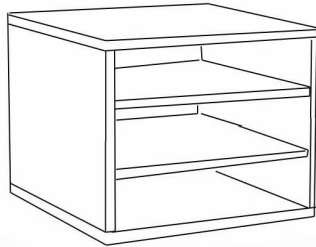

APPLIES TO:
WH2040

List of Hardware:



1.) Screw in & insert all cam pins, cam locks and wood dowels in both Side Panels, Shelves, Top Surface & Bottom Panel.

2.) Start with assembling this unit on its side by selecting one of the two Side Panels. Connect the Back Panel first. Use your screwdriver to twist the cam locks to secure the connection like in Figure 1.

Tools Needed:

-Phillips Screwdriver

3.) Next, attach both Fixed Shelves to the Side Panel and Back Panel

4.) Then, attach the other Side Panel.

5.) Attach Top Surface and Bottom Panel

6.) Use the white stickers to cover the cam locks.

Special Note:

Location & number of cam pin, cam lock and dowel holes may vary.

Figure 1

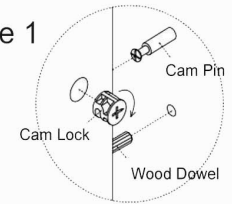

Exploded diagram of parts

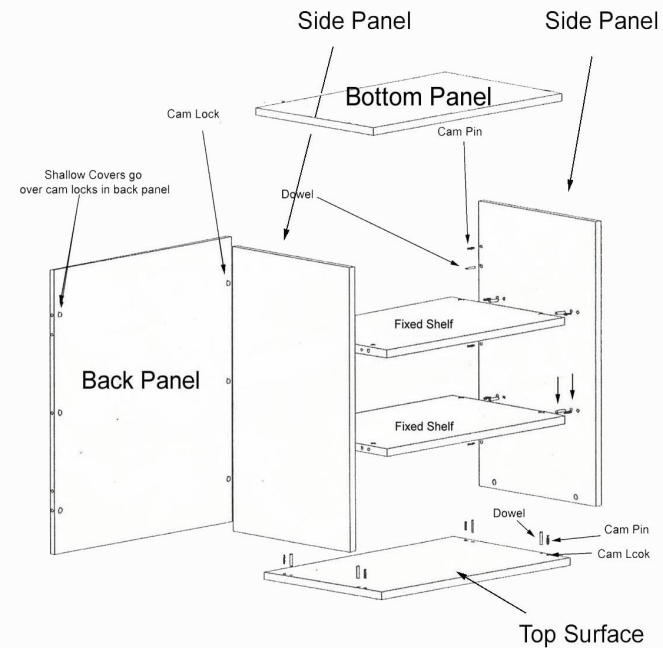

Questions? Please call 1-800-443-5117.





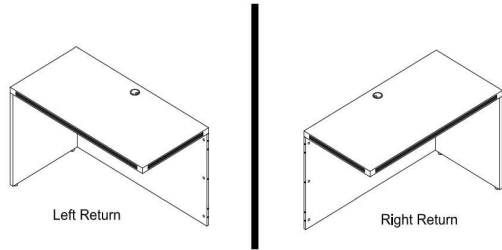





Customer Service available 8:30 - 5:00 Central Time, Monday - Friday

Reversible Desk Return Assembly Instructions



Applies to:
BK/CH/FL/MJ/ML/WH2045

List of Hardware:

| Part | Part | Part |
|---------------------------------------------------------------------------------------------------|----------------------------------------------------------------------------------------------------|---------------------------------------------------------------------------------------------------------------|
|  Wood Dowel |  Shallow Cover |  Worksurface Bracket |
|  Cam Pin |  Deep Cover |  Side Panel Brackets (2) |
|  Cam Lock |  Grommet |  M6 Screw |
|  Wood Screw | |  Leveling Glide |

Tools Needed:

- Phillips Screwdriver
- Power Screwdriver
- A Helper

- 1.) Assemble on carpet or cardboard to protect parts during assembly. Assembly will require 2 people for safety.
- 2.) Determine if the return will be left or right handed (see diagram next page). Locate Side Panel & End Panel and arrange like shown in drawing. Insert leveling glides, then insert all cam pins, cam locks and wood dowels. Then connect the panels by inserting the dowels into the holes on opposite panel and inserting cam pins into cam locks (see diagram). Then, twist the cam locks with a Phillips Screwdriver to secure connection.
- 3.) Next, locate the Desktop and insert hardware. Then, set the desktop on the lower assembly and twist cams to securely connect.

Special Note:

Location & number of cam pin, cam lock and dowel holes may vary.

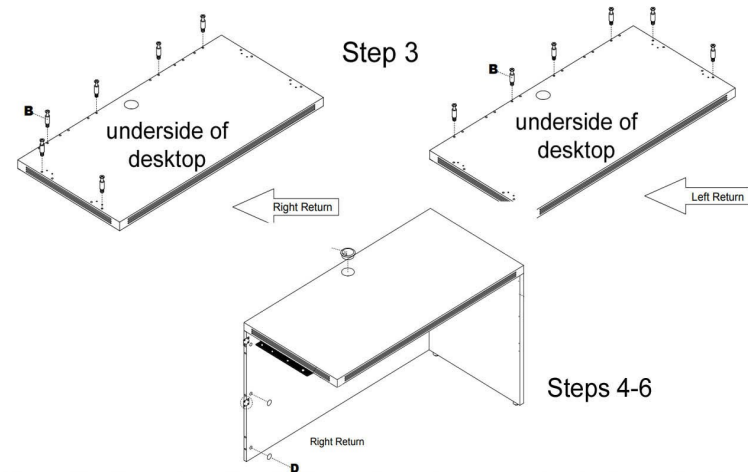
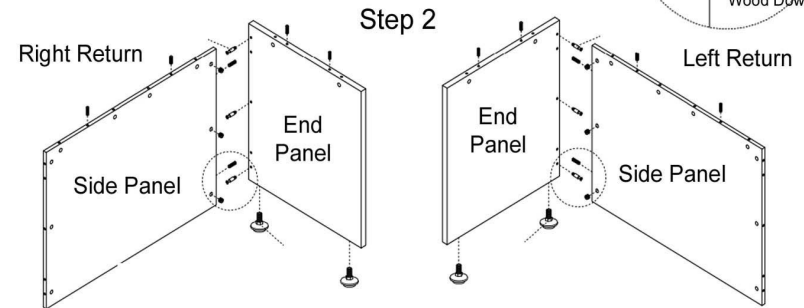
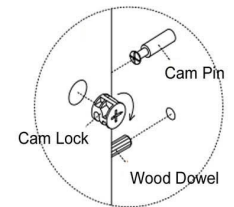

- 4.) Now it's time to attach the return to your desk. Locate the large flat bracket and M6 machine screws (it may be attached to the desktop already. If not, center the bracket over the edge and install 4 of the screws). With a helper, have one person hold the return desk stable while the other screws the machine screws into the desk.
- 5.) Once installed & leveled, use the wood screws to install the offset side panel brackets. This will further secure the side panel, but is an optional step. A power screwdriver is helpful.
- 6.) Lastly, insert the grommet into the desktop and use the caps provided to cover the cam locks.

Questions? Please call 1-800-443-5117.

Customer Service available 8:30 - 5:00 Central Time, Monday - Friday

4-Door Hutch Assembly Instructions

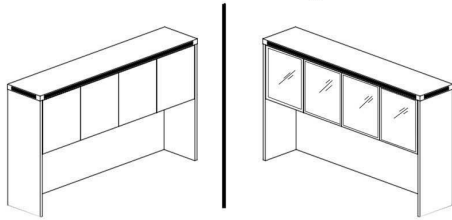









Applies to:
BK/CH/FL/MJ/ML/WH2044
MJ2025-CHL

Questions? Please call 1-800-443-5117.

Customer Service available 8:30 - 5:00 Central Time, Monday - Friday

List of Hardware:

| Part | Part | Part |
|-------------------------------------------------------------------------------------|-------------------------------------------------------------------------------------|----------------------------------------------------------------------------------------------|
|  |  | Qty 4  |
| Wood Dowel | Cam Lock Cap | Outside Door Hinge |
|  | | Qty 4  |
| Cam Pin | | Inside Door Hinge |
|  |  | Qty 8  |
| Cam Lock | Grommet | Hinge Plate |

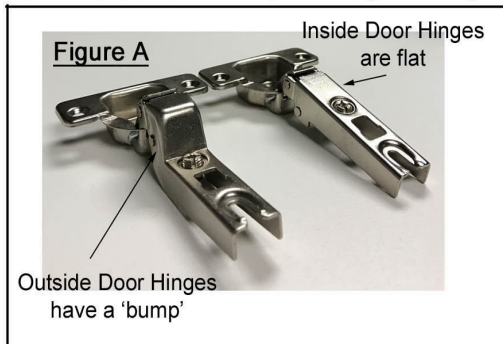

- 1.) Locate the Back Panel, Left & Right Side Panels and Center Shelf. Insert all wooden dowels, cam pins and cam locks. Connect Back Panel to the Center Shelf. Then connect the Left Side Panel, then Right Side Panel. Once all panels are connected, use your screwdriver to twist the cam locks to secure the connections.
- 2.) Connect the Middle Support Panel in same method.
- 3.) Attach Top Surface in same method.
- 4.) Attach all 8 Hinge Plates to the inside walls of the hutch. Use two per door. The holes are piloted. **DO NOT TIGHTEN DOWN THE SCREWS ALL OF THE WAY. LEAVE WIGGLE ROOM!**

Tools Needed:

- Phillips Screwdriver
- A Helper

Special Note:

Location & number of cam pin, cam lock and dowel holes may vary.

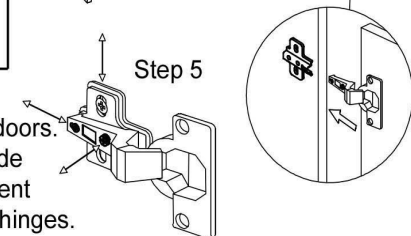
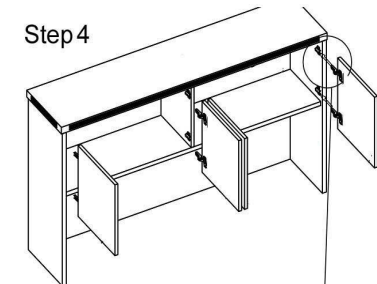
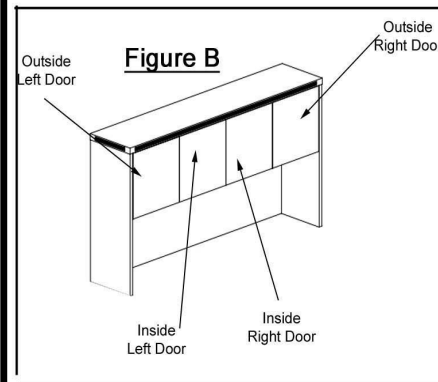
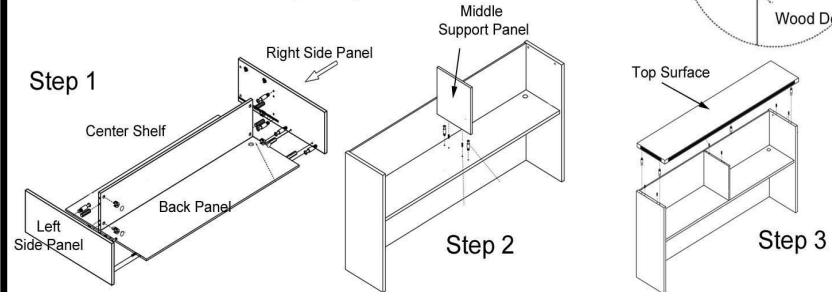
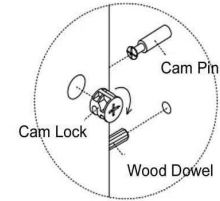

- 4.) Your next step is to attach the hutch doors. See Figure "B" which identifies the Outside Doors and Inside Doors. There are different hinges that connect the inside & outside hinges. See Figure "A" to help identify. Attach two hinges per door. Use the hinges with the 'bump' on the Outside Left & Right Doors and the flat hinges on the Inside Left & Right Doors. The holes are piloted. Use the screws provided. Once the hinges are attached, slide the hinges over the Hinge Brackets, fitting the screw head of the Hinge Bracket in the slot of the Hinge. Once fitted, slightly tighten the set screw. Now, set your hutch on your desk. Use the double-sided tape to securely adhere to desktop.
- 5.) Next, it is time to adjust the doors so that they properly align. Using your screwdriver, turn the Set Screw on the hinge to adjust the depth and the screws on the hinge plate to move the door up/down.
- 6.) Last step is to install Cam Lock Caps and Grommet cover.

Video on Hinge Door Adjustment available at link:

<http://www.modernofficefurniture.com/office-furniture-assembly-instructions.html>

"How to Adjust Hinges on 4-Door Hutch"