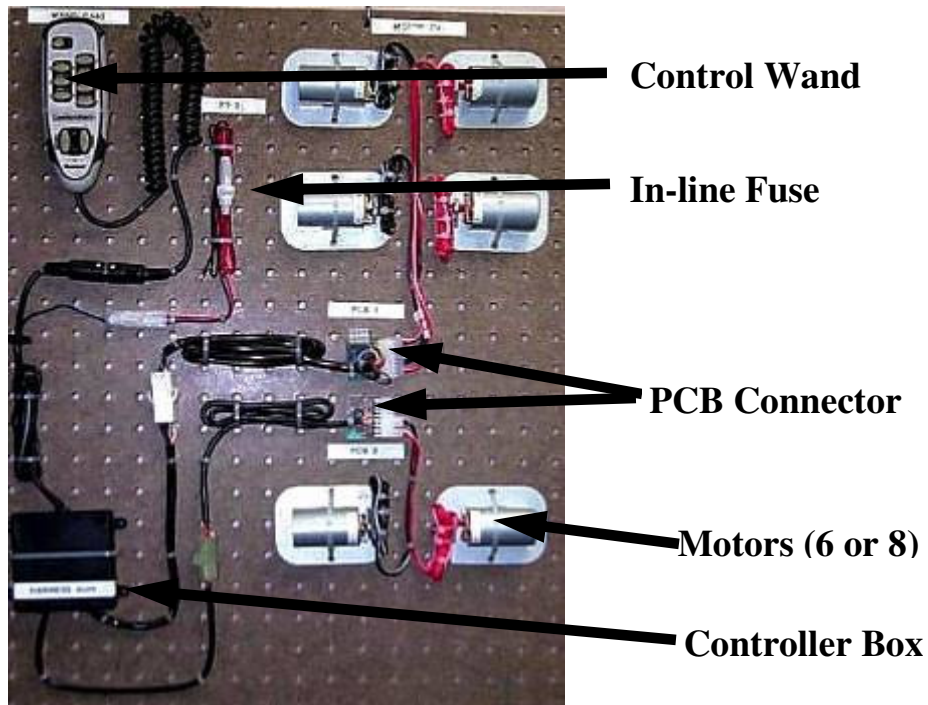

Table of Contents

- I Required tools
- II System Configuration
- III Motor Placement Bottom
- IV Motor Placement Back
- V Motor Installation into Foam
- VI Needle Punch Application
- VII Lumbar Heat Element
- VIII Printed Circuit Board
- IX Wiring placement
- X System Power Connection
- XI Control Wand Attachment
- XII Troubleshooting

System Components



I. Required Tools

- * Ruler
- * Marker
- * Tie Wraps
- * Cutters
- * Foam Spray Glue
- * Tracing Template
- * Utility Blade (1x2)
- * Screwdriver
- * Hog Rings
- * Hog Ring Tool
- * Needle Punch
- * 1/4" Foam (optional)



II. System Configuration

RoadComfort™ components have been engineered for quick and easy installation. This installation manual depicts a general installation RoadComfort™ system into a factory automotive seat. The specific guidelines of the motor placement have been determined for optimal effectiveness and comfort of the vibrotactile massage system. Any variance to these measurements greater than 1” may alter the effectiveness of the system. **If the generic placement dimensions conflict with the seat design (foam/trim), please contact Relaxor’s Technical Help Line at 1-562-447-1780 ext. 216 to guide you in the correct placement of the motors.**

The system comes in either a 4-zone / 8 motor configuration or 3-zone / 6 motor configuration. The motors can be configured with 6 motors in the back and 2 motors in the bottom, 4 motors in the back and 4 motors in the bottom or with 4 motors in the back and 2 motors in the bottom. The configuration of the motors is determined by the desired massage area and by the configuration of the seat back and cushion.

This manual demonstrates the installation of a 4 motor back / 4 motor bottom (4X4) and a 6 motor back / 2 motor bottom (6X2) system.

III. Motor Placement-Bottom

2-Motor Bottom

Remove the seat bottom cover to expose the motor placement area. Determine the center line of the foam cushion and mark a line on it. Measure 4" from the leading edge of the cushion and 5" from the center line. Position the tracing template so the axis of the motors runs parallel to the occupants legs (as shown below)

Motor Cavity Cutout Template

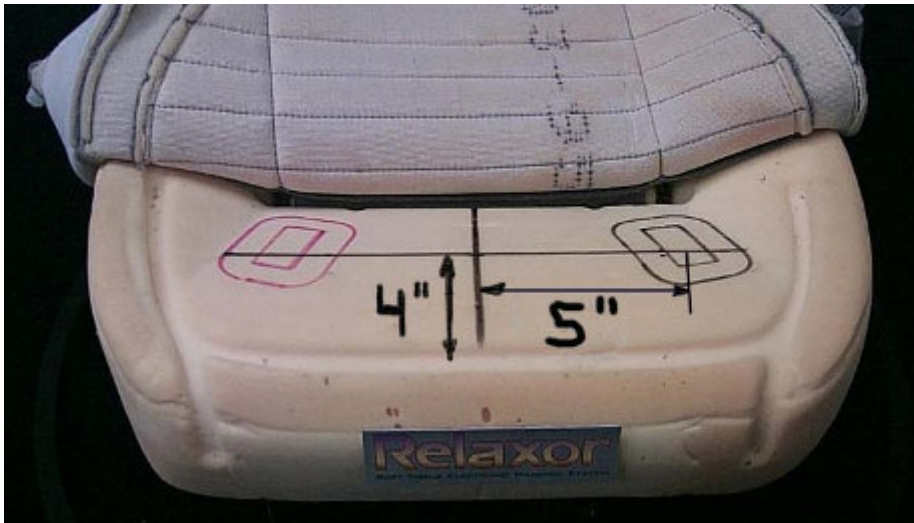
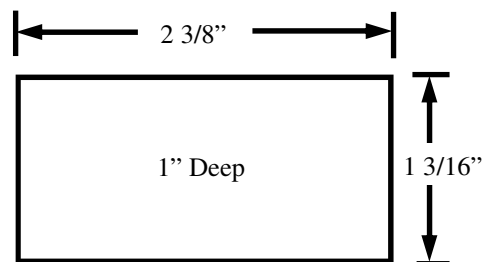

III. Motor Placement-Bottom

4-Motor Bottom (4X4 Configuration)

Remove the seat bottom cover to expose the motor placement area. Determine the center line of the foam cushion and mark a line on it. Measure 4" from the leading edge of the cushion and 5" from the center line. Position the tracing template so the axis of the motors runs parallel to the occupants legs (as shown below) and then trace the outline of the front motors. Repeat for the rear motors by measuring 8.5" from the leading edge and 3.5" from the center line and trace the outline of the motors.

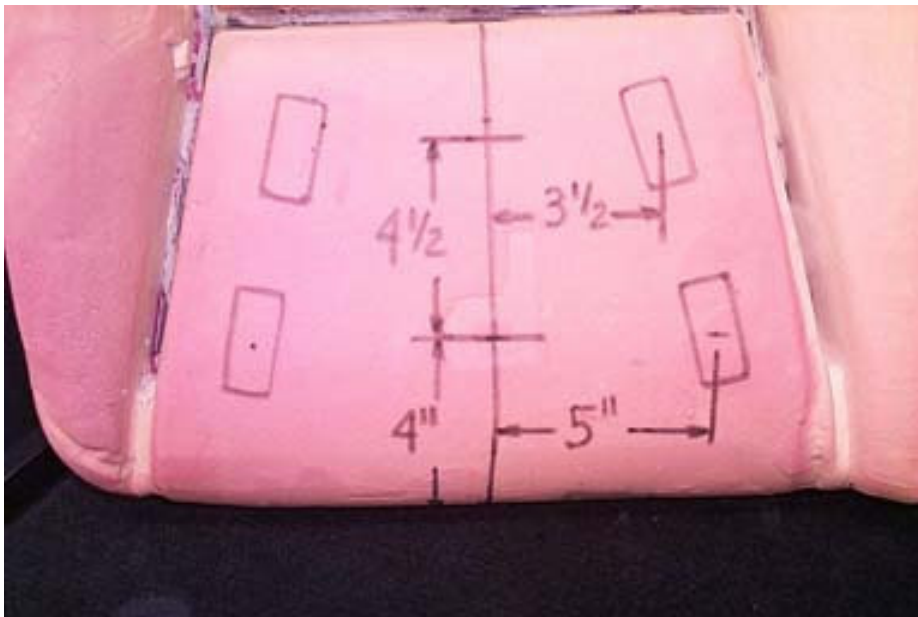

IV. Motor Placement-Back

4-Motor Back

Remove the seat back cover to expose the motor placement area. With a scale, draw in the centerline of the seat back. Measure 5" from the seat cushion and 2 1/2" to each side and mark the point. Measure 11" from the seat cushion and 2 1/2" to each side and mark that point. Center the template and trace in the motor cutouts.

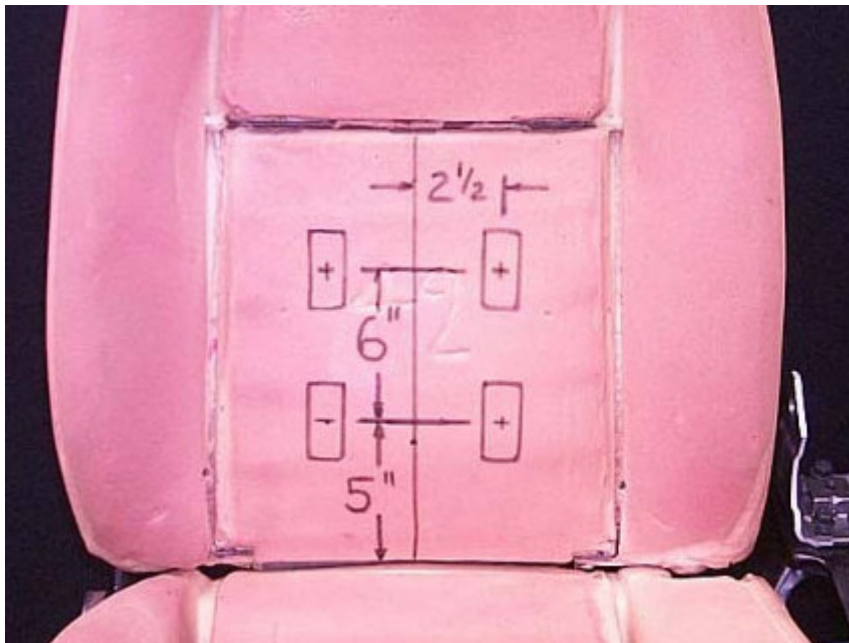

IV. Motor Placement-Back

6-Motor Back

With a scale, draw in the centerline of the seat back. Measure 5" from the seat cushion and 2 1/2" to each side and mark the point. Measure 9 1/2" and 14" from the seat cushion and 2 1/2" to each side and mark the points. Center the template and trace in the motor cutouts.

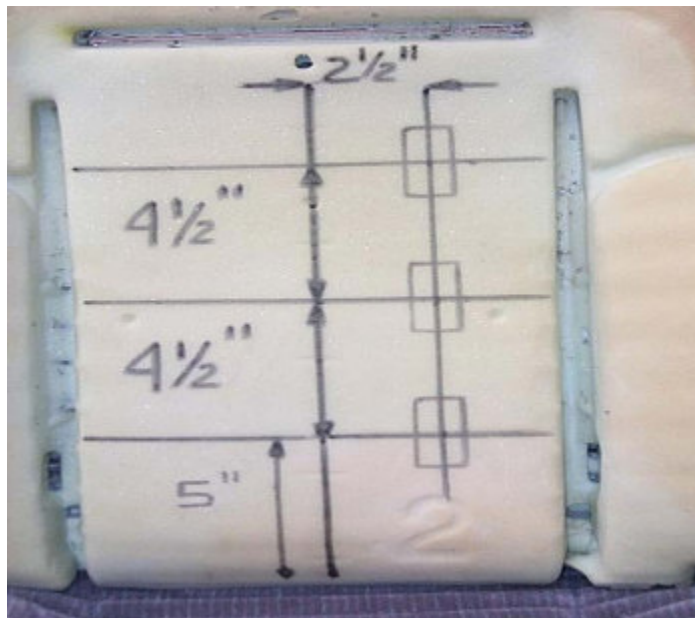

V. Motor Installation Into Foam

Foam Cutout

To cut the massage motor cavity, place the blade on the long side of the foam at the trace outline and cut into the foam until the blade is flush with foam (approximately 1" deep). Repeat on opposite side.

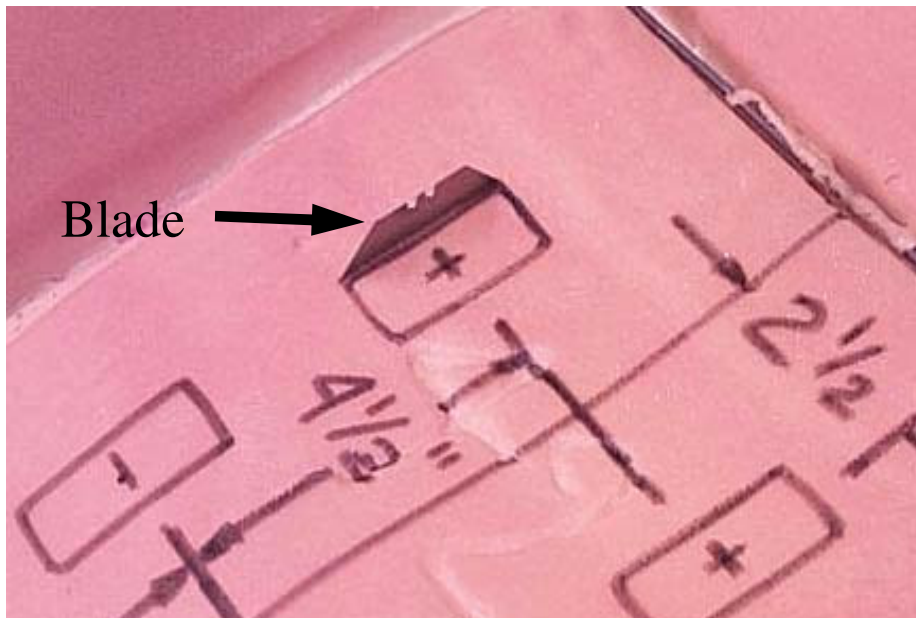

V. Motor Installation Into Foam

Foam Cutout

Insert the blade vertically into the foam and cut approximately 1" into the foam. Repeat on opposite side.

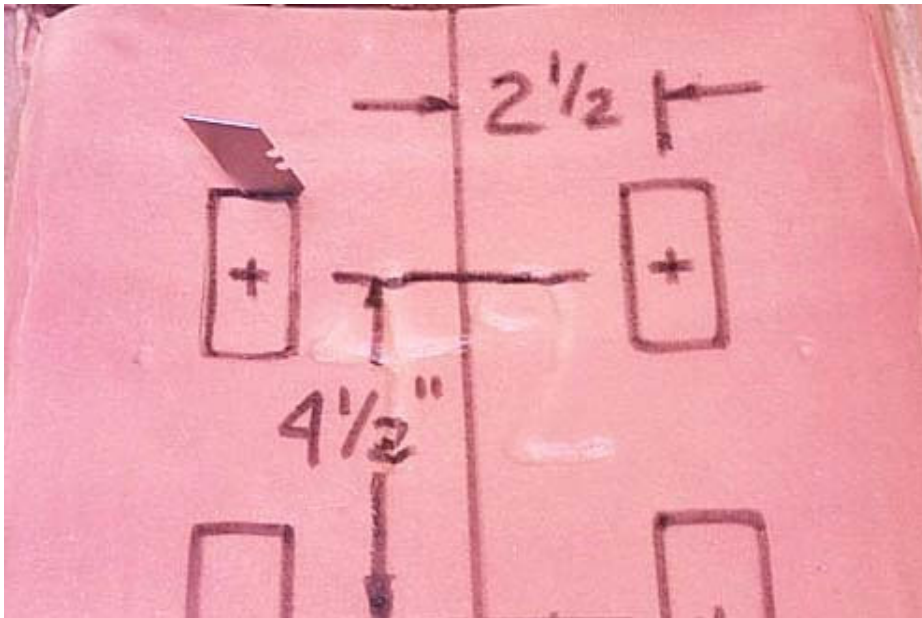

V. Motor Installation Into Foam

Foam Cutout

Cut out the foam to receive the shape of the motor housing by pulling back the long cut of the foam and placing the blade on an angle and cut towards the center. Repeat this on the other side and remove the foam cutout.

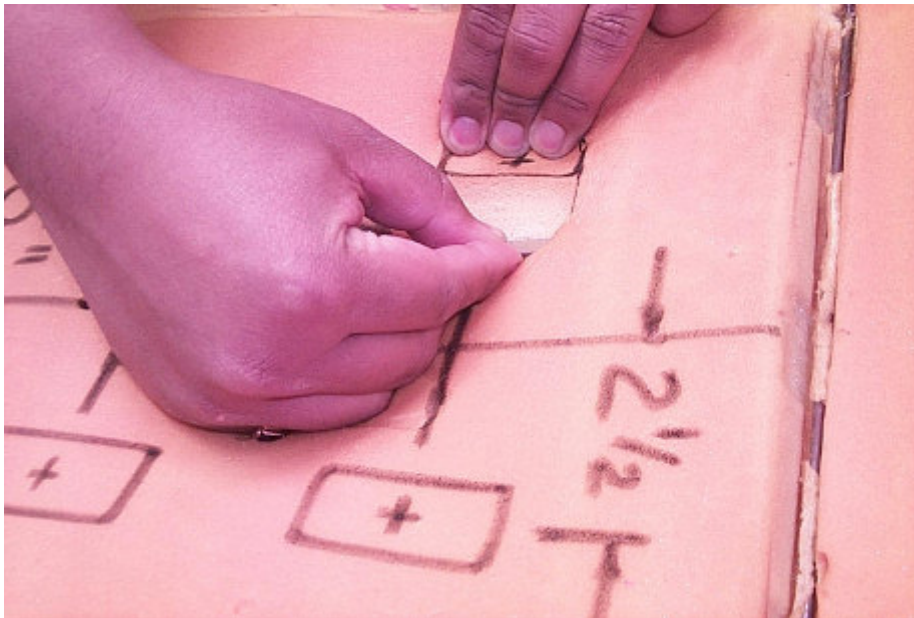
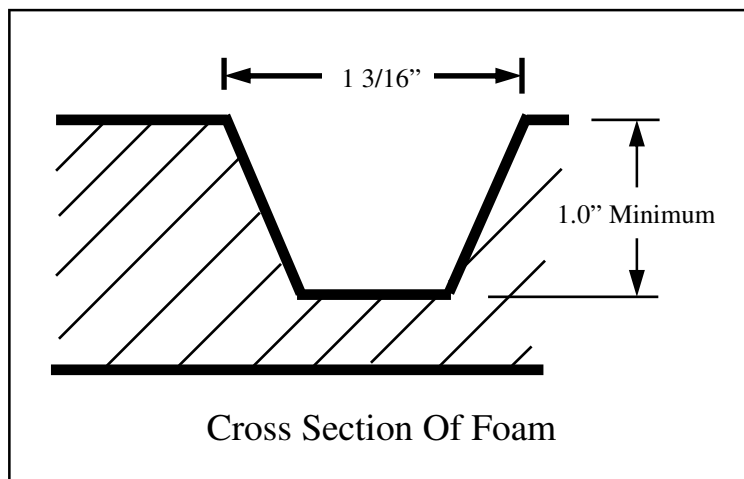

V. Motor Installation Into Foam

Motor Wire Foam Cut

With the knife blade, cut a slot into the forward facing edge of the foam cavity. This is where the wire will pass through to the back side of the foam cushion. The slot must be cut into the front facing edge of the cutout on the seat cushion or towards the top of the seat back cushion.

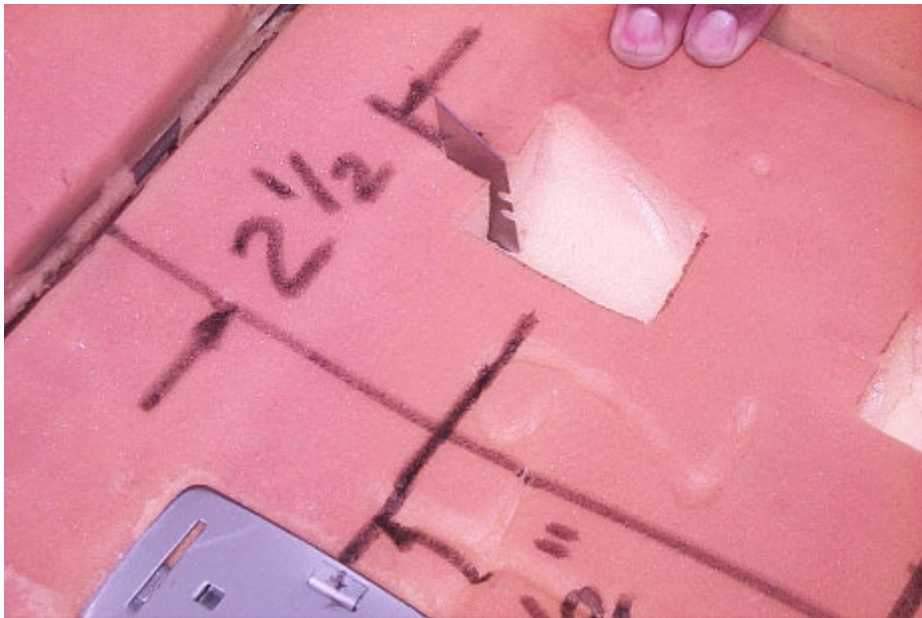

V. Motor Installation Into Foam

Install the motors with the corresponding tagged connectors in the zones specified below.

4-Zone System

Zone 1: Top of back cushion (M1R,M1L)

Zone 2: Middle of back cushion (M2R, M2L)

Zone 3: Bottom of back cushion or rear of seat cushion (M3R, M3L)

Zone 4: Front of seat cushion (M4R, M4L)

3 Zone System:

Zone 1: Middle of back cushion (M1R, M1L)

Zone 2: Bottom of back cushion (M2R, M2L)

Zone 3: Front of seat cushion (M3R, M3L)

Pass The Motor Wires Through The Foam Making Sure That The Motor And Wire Connections Are Facing Towards The Front Of The Seat Cushion Or Towards The Top Of The Seat Back Cushion

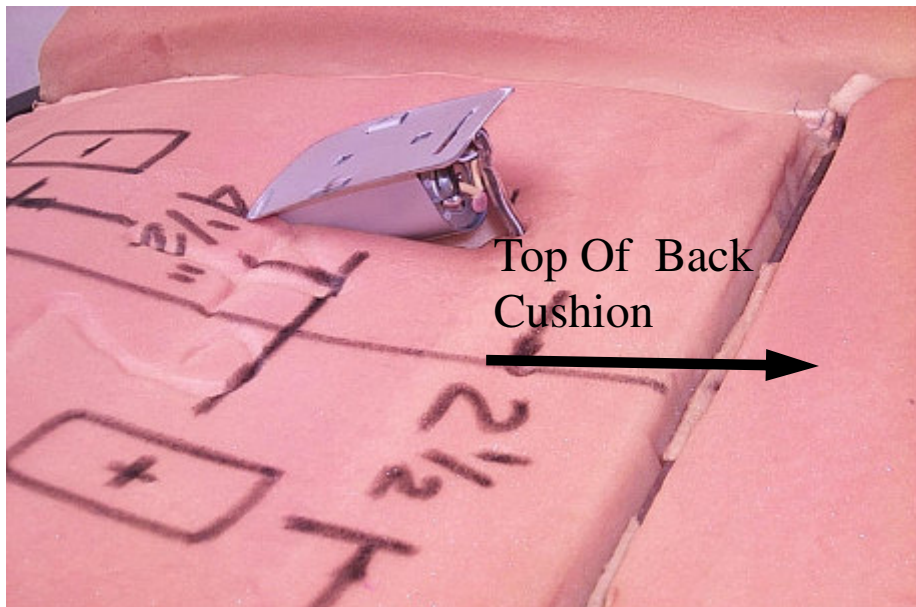

V. Motor Installation Into Foam

Gluing Motors

Using spray glue, apply into the foam cavity and onto the backside of the motor plate and wait 30 seconds. Place motor into foam cavity and gently pull the motor wires to insure a tight fit. Apply pressure to the top plate and hold against the foam for 15 seconds.

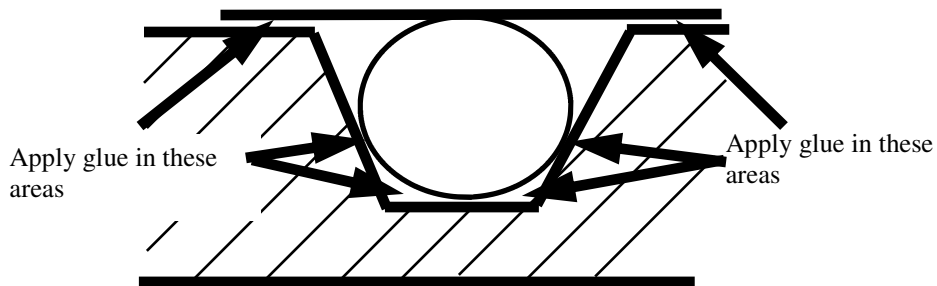

Cross Section Of Foam

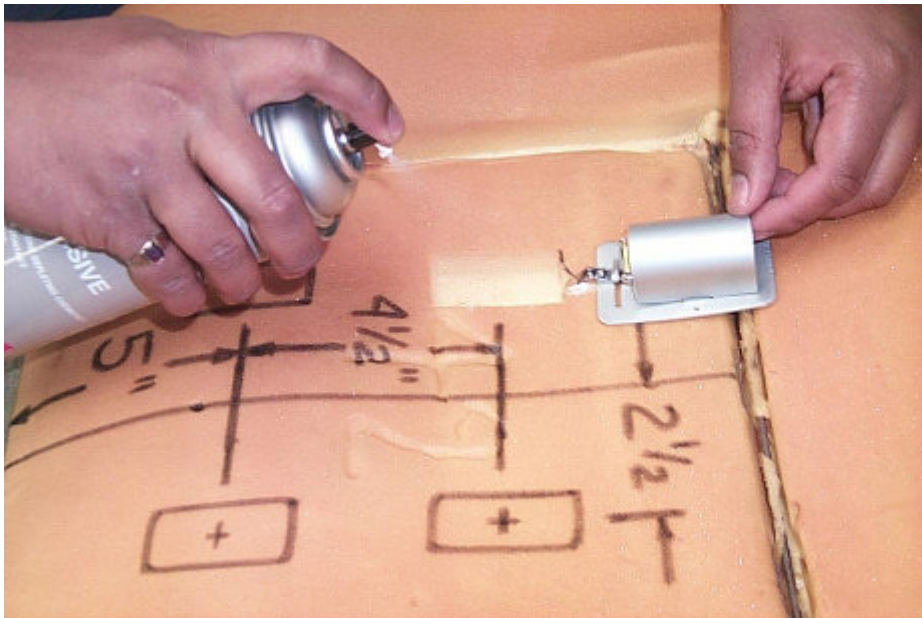

V. Motor Installation Into Foam

Wire Sleevings Trim

Turn the foam cushion over to expose the back side and make certain that the wires are snug. Trim any excess wire sleevings that protrudes above the foam surface.

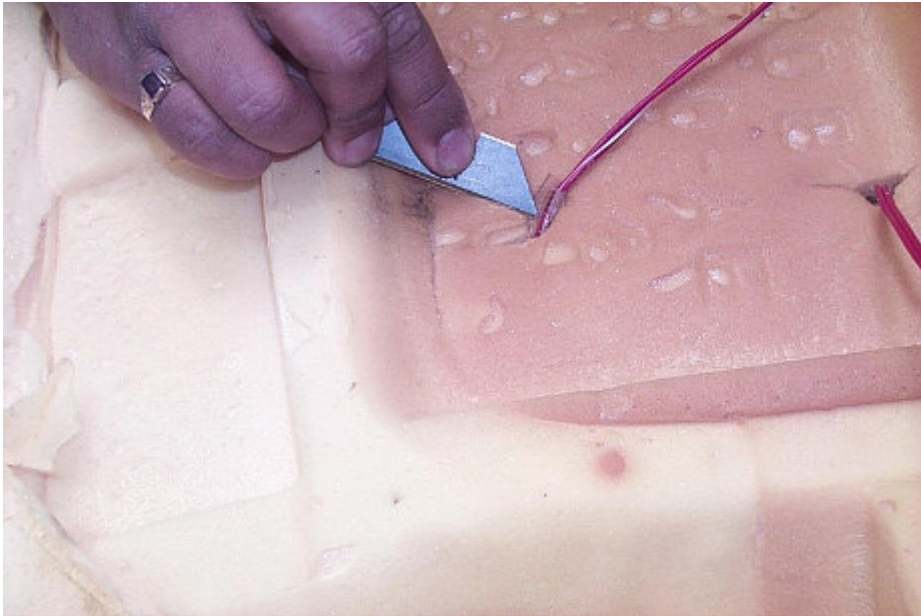

V. Motor Installation Into Foam

Completed Bottom Cushion

The photo below shows the completed installation of the motors in the seat cushion (4 Motor Example).

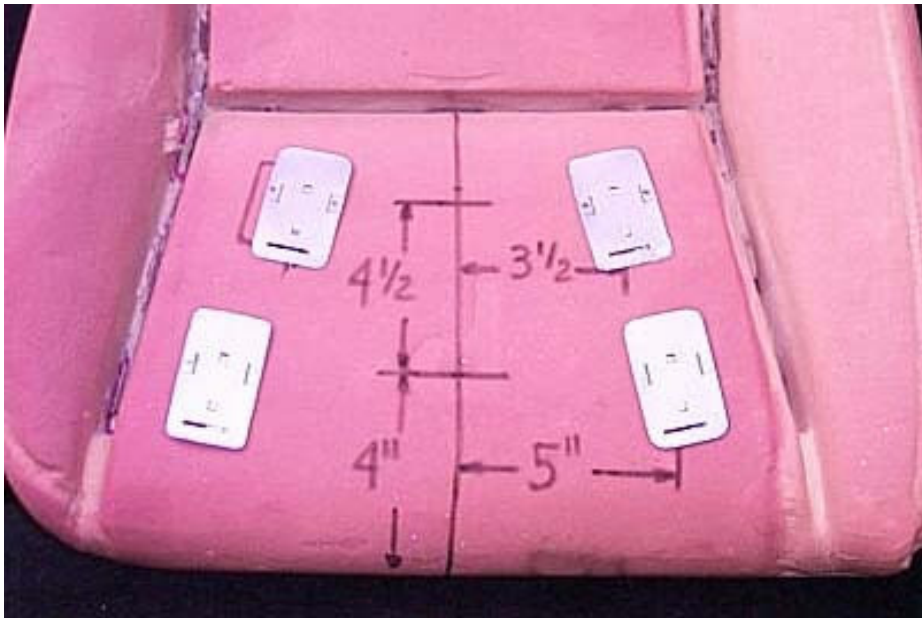

V. Motor Installation Into Foam

Completed Back Cushion

The photo below shows the completed installation of the motors in the seat back (4 Motor Example).

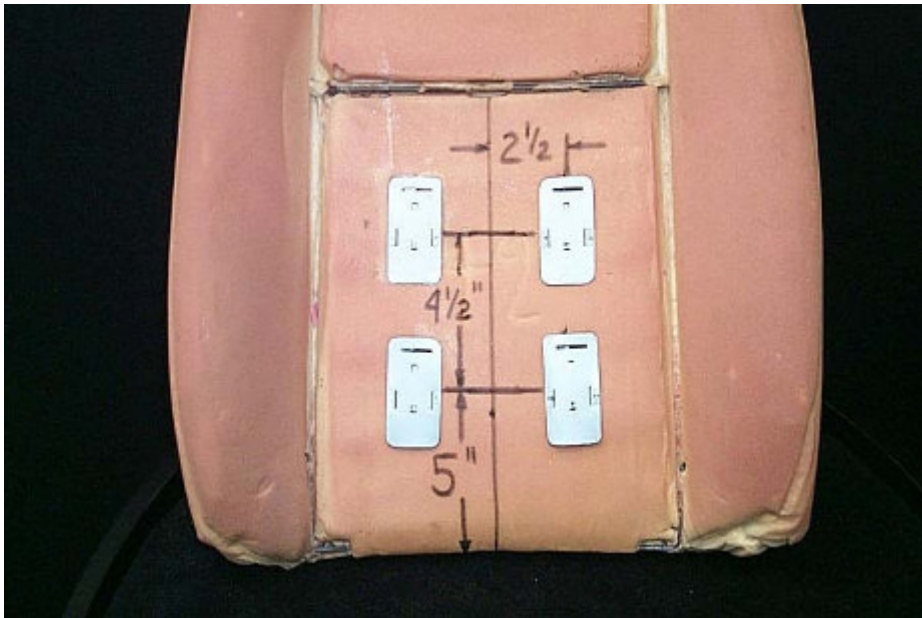

VI. Needle Punch Application

To insure proper comfort, there must be sufficient padding between the motors and the seat cover. In most cases, the cover has an integrated plus pad attached. In this case, the needle punch would be adhered to the surface of the foam as shown below. If the cover has no plus pad, 1/4" open cell foam with the same I.L.D. as the foam pad would be added with the needle punch.

Place the needle punch pad onto the foam cushion and trace around the edge of the foam or tie down channels as shown below. Using scissors, cut out the needle punch and adhere to the surface of the foam with the spray adhesive.

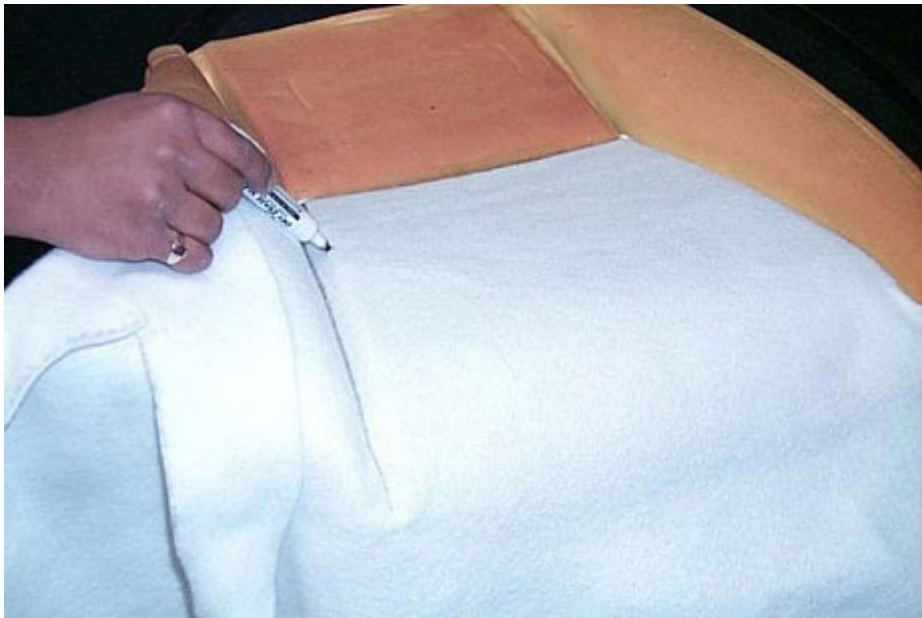

VI. Needle Punch Application

Seat Bottom Needle Punch

The photo below shows the final installation of the needle punch on the seat bottom.

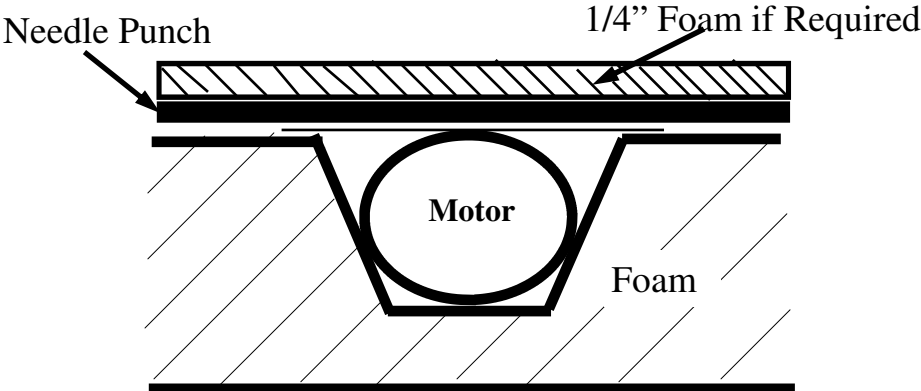

Cross Section Of Foam

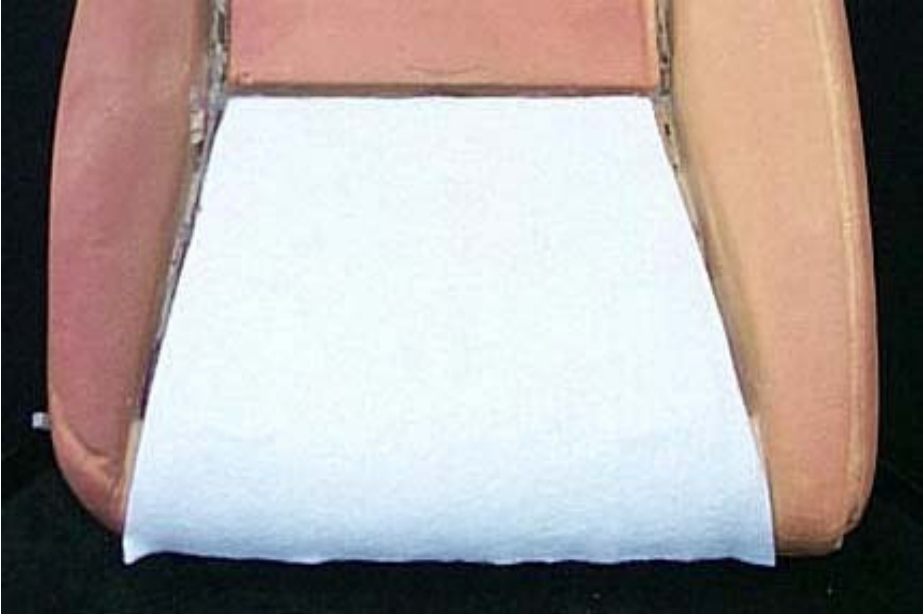

VI. Needle Punch Application

Seat Back Needle Punch

The photo below shows the final installation of the needle punch on the seat back.

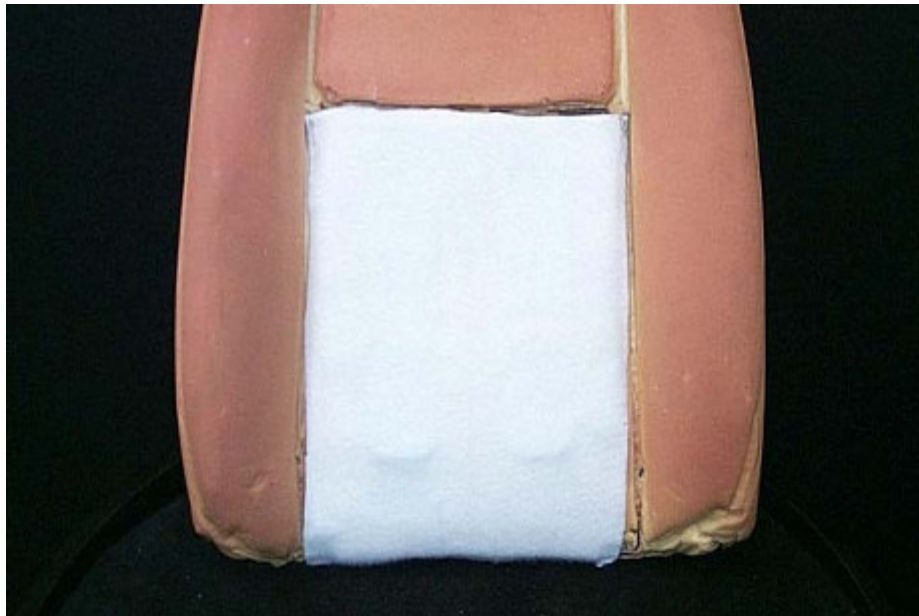

VII. Lumbar Heat Element

Heater Thermostat Cutout

Determine the center line of the seat back and draw a 2 1/2" vertical line that is 4" up from the seat bottom. This will be the location for the lumbar heat element thermostat. Cut a slit into the foam approximately 1" deep.

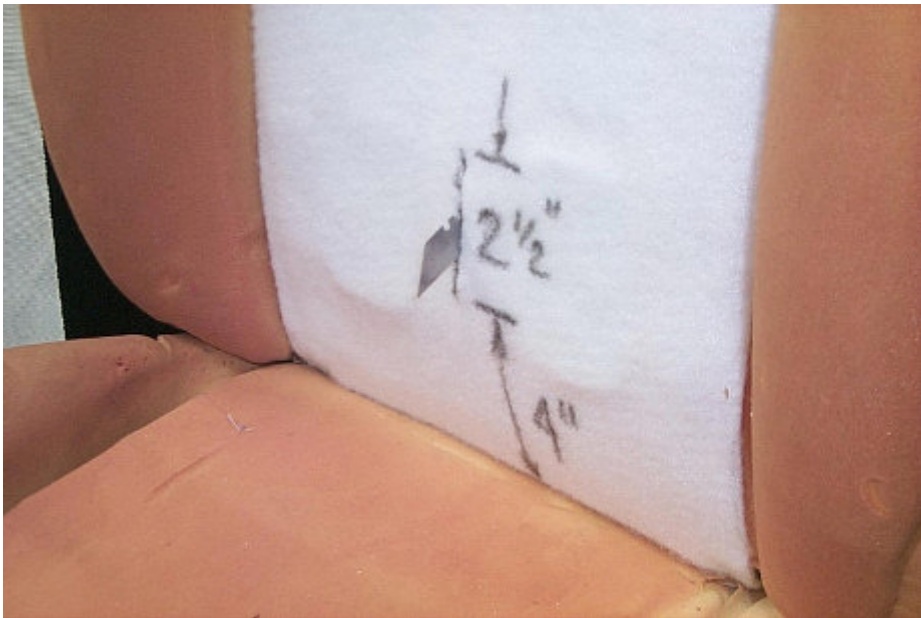

VII. Lumbar Heat Element

Heater Pad Location

Locate the heater pad on the seat back. With the utility blade, slice through the needle punch through the foam at the side of the foam cushion as shown below. Pass the heater wire through the back cushion.

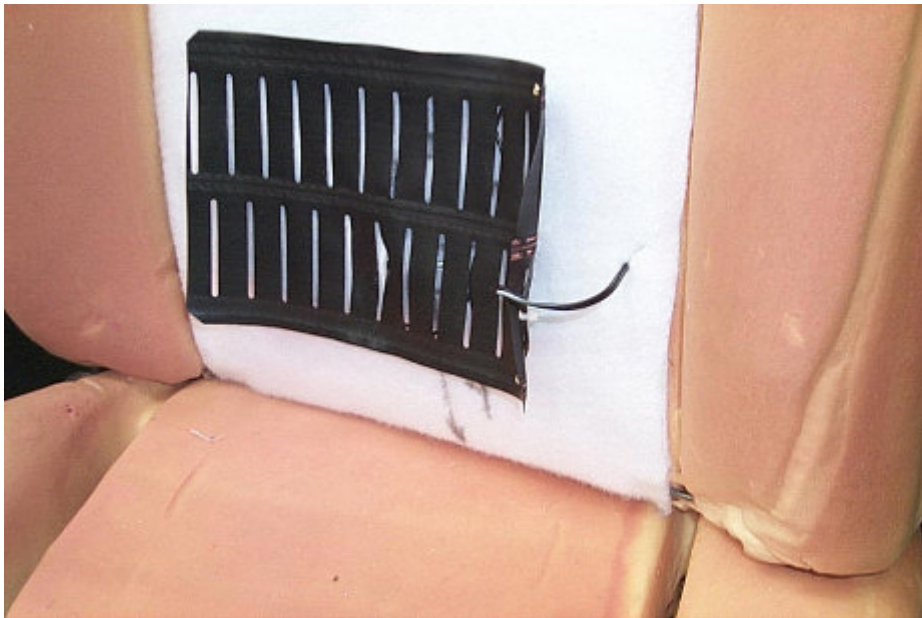

VII. Lumbar Heat Element

Heat Element Gluing

Apply the spray glue on the needle punch material and to the heat element. Position the Heater pad thermostat so it slips into the vertical slit and attach to the foam. Apply pressure to the mat and hold for 30 seconds.



VIII. Printed Circuit Board

Printed Circuit Board Connection

Attach the motor wires to the PCB connector (below), matching the corresponding numbered wires to the numbers on the printed circuit board. Insulate the PCB by imbedding the PCB into the back of the back foam cushion and cover with needle punch or wrap the PCB with electrical tape.

CAUTION:

Do not leave wires or PCB between seat foam and seat frame or suspension, as this may cause the wires to pinch and Short Circuit the system.

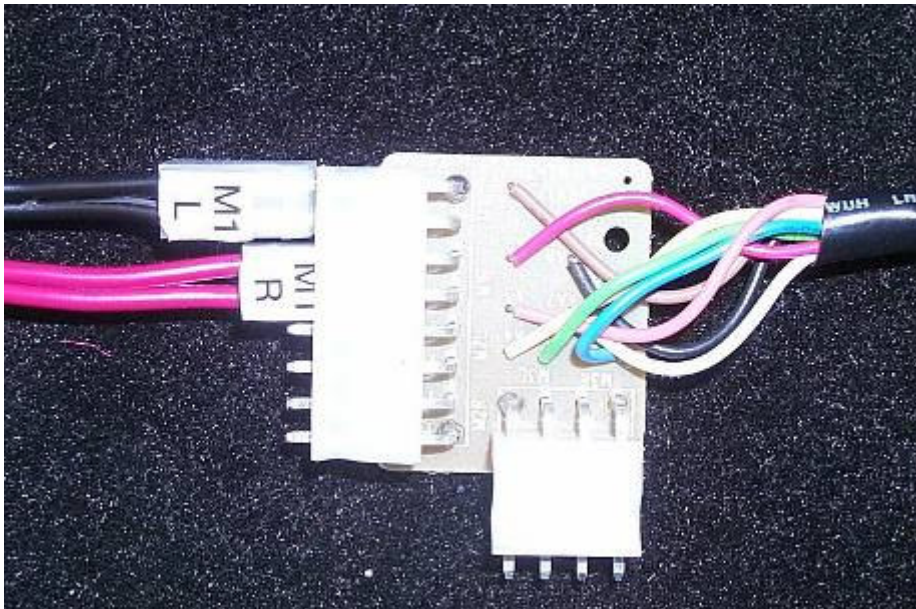

VIII. Printed Circuit Board

PCB Placement Back: Cut out a 2 1/2" X 2 1/2" X 1/2" deep square into the foam and glue in the PCB connector. Cut 1/2" slices into the foam and embed the wires into the foam. Cut a piece of needle punch and adhere it over the entire PCB area for added protection. Bundle and organize the remaining wires. Re-Cover the seat back.

PCB Placement Bottom: Insulate the PCB with electrical tape to insure that the PCB does not short circuit to the seat frame components. Attach the PCB to the underside of the seat frame components with tie wraps as shown on the next page.

CAUTION: Do not leave wires or PCB between seat foam and seat frame or suspension, as this may cause the wires to pinch and Short Circuit the system.

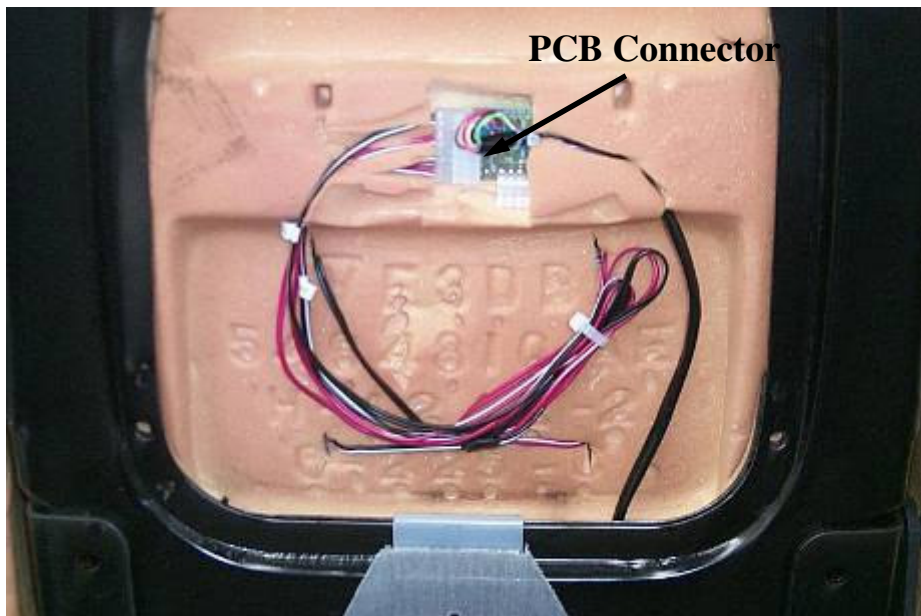

IX. Wiring Placement

Seat Bottom Cushion

Route the wires down the seat back and pass them to the rear of the bottom seat cover. Cut an entry hole at the rear of the bottom seat cover and pass the wire harness through or tuck the harness around the rear of the seat cushion. Attach the controller box to the seat frame components with tie wraps and connect all wiring and the controller wand. Bundle up and organize the loose wiring with tie wraps as shown below.

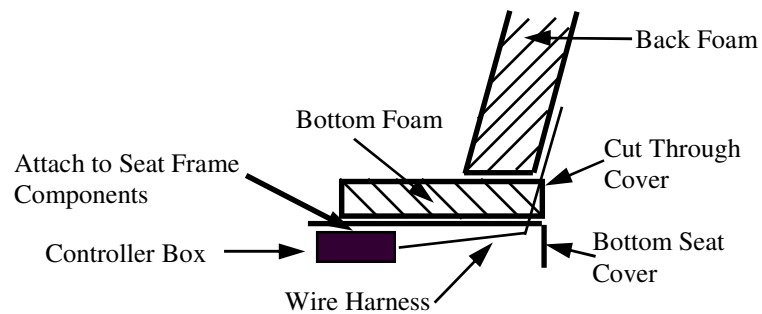

X. System Power Connection

System Connection

Connect the power wire harness to the **White 2-pin Connector** power connector at the control box as shown below.

Connect the control wand to the control box by lining up the white dots on the connectors and joining the **Black 8-pin Connector** together.

Connect the **White 9 pin PCB** connectors together.

Connect the **Green 6 pin PCB** connector together.

Connect the **White 2 pin** heater connector (optional)

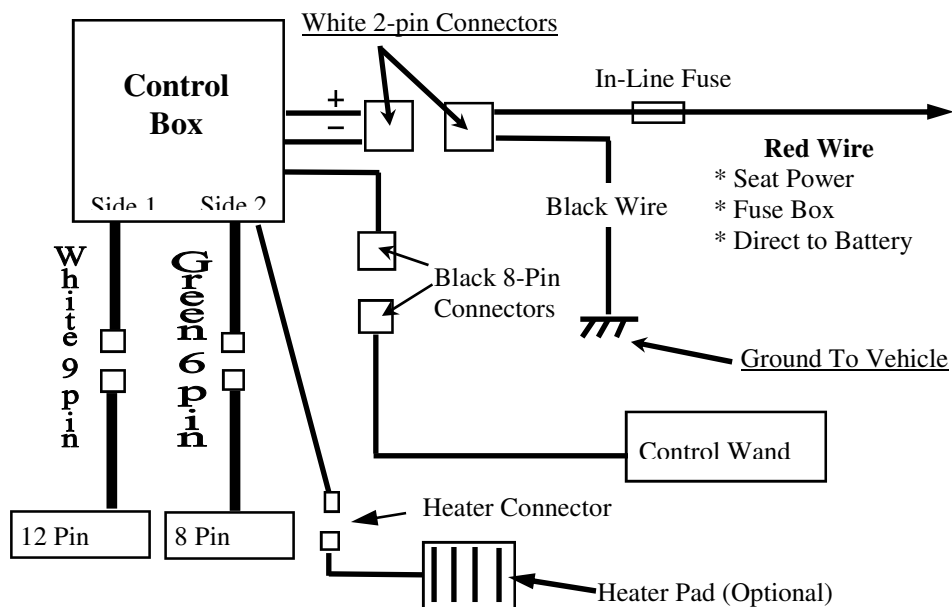

X. System Power Connection

Power Connection To Vehicle

If the vehicle is equipped with an Anti-Theft Radio, the radio code must be recorded prior to disconnecting the battery.

Disconnect the **NEGATIVE BATTERY CABLE** before installing the massage system.

Connect the power harness to a harness extension and run it under the carpet and along the scuff plate toward the fuse box.

Run the power wire to fuse box power.

Install the negative wire to the OEM ground screw and secure in place.

Power Seat Connect Option

If available, connect the red wire (**positive**) to the power seat mechanism power wire.

Fuse Box Wiring

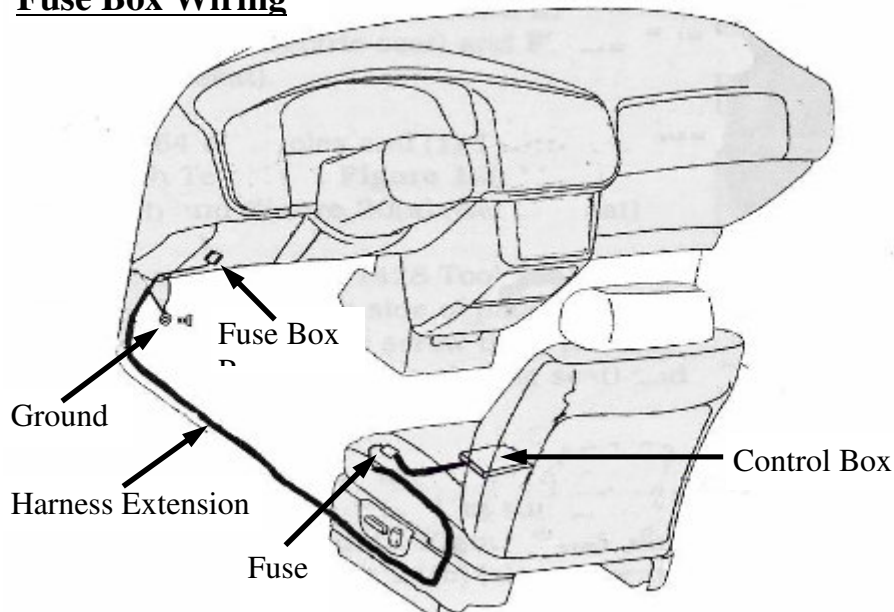

XI. Control Wand Attachment

Wand Tray Installation

Using the optional control wand tray, position and trace the outline on the side of the seat foam or desired mounting location. Remove the material, spray the adhesive into the pocket area and onto the back of the control wand tray, place the wand tray in the pocket and hold for thirty seconds.

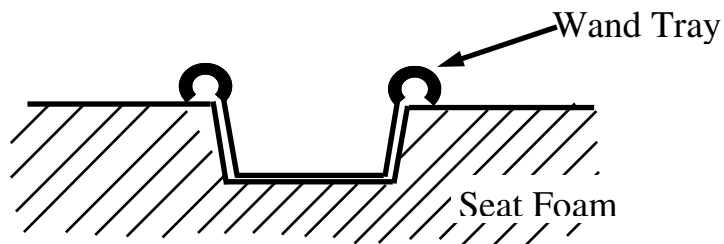

XI. Control Wand Attachment

Control Wand Attachment

To mount the wand, use Velcro on the back of the wand and any general location near the operator. The general locations are: seat belt (shown below), center console or to the side of the seat.



XII. Troubleshooting

System Does Not Function:

Verify that the wand is securely connected.

Verify that the power connector is securely connected.

If the power connection is secure, check the voltage at the connector and verify that the polarity is correct. If the polarity is reversed, the system will not operate.

Check fuse. Replace fuse if blown.

If fuse blows, check all wiring for possible short to ground on metal seat frame and components.

Massage Zone Not Cycling Properly:

Check the PCB connector and verify that the connections are secure.

Technical Help (1-562-447-1780)

Customer Service: Ext. 200

Quality Control: Ext. 216