

Hydronic Omnipanel Specifications

Model : TW21

Height : 61.1"

A Connection CL to Wall : 2.8"

Bracket to Bracket : 49.5"

Z Connection Wall to Panel : 2.0"

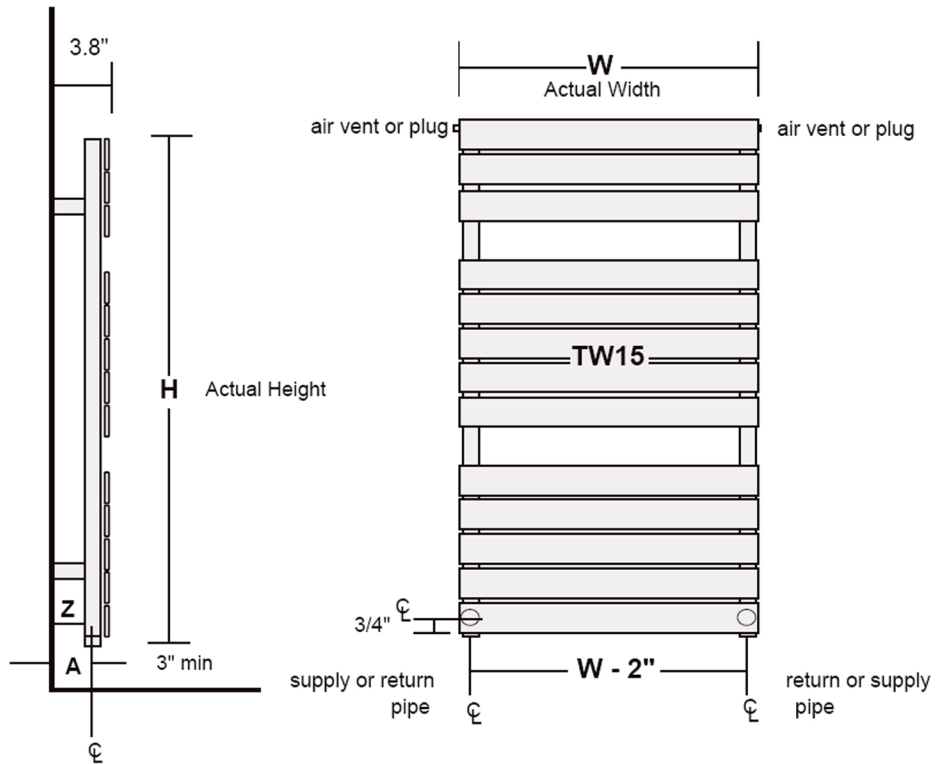

Mounting Bracket Locations

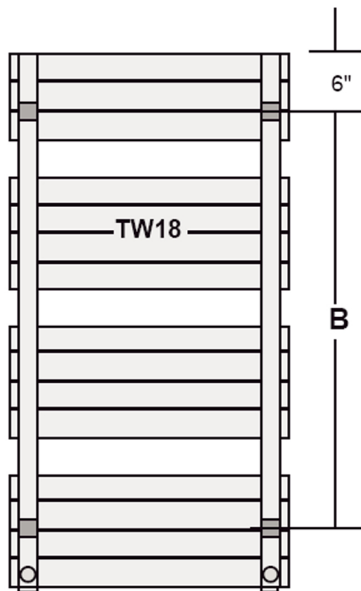

Actual Width W	16 in	20 in	24 in	30 in	36 in
Pipe CL to CL	14 in	18 in	22 in	28 in	34 in

Runtal North America, Inc.
 187 Neck Road
 PO Box 8278
 Ward Hill, MA 01835
 1-800-526-2621
 In Canada: 1-888-829-4901
 Fax 1-978-372-7140
<http://www.runtalnorthamerica.com>
info@runtalnorthamerica.com