



**WIRE ROPE  
ELECTRIC  
HOISTS**

**SHAW-BOX®**

Over time, companies come and go, but one has remained the leader in the overhead materials handling business for over a century. The company where it all started is still setting the industry standards today.

In 1888, Alton J. Shaw developed the first electric overhead traveling crane. Soon after, the Shaw Electric Crane Company was born in Muskegon, Michigan. From the outset, the Shaw Crane Company remained committed to pioneering new technology in response to changing industry demands.

In 1932, the Shaw Crane Company merged with the Alfred E. Box Crane and Hoist Corporation, inventors of the first electric cable hoist. Together, the two companies continued to lead, revolutionizing the way heavy materials are handled. The LOAD LIFTER electric hoist, first pioneered in 1921, has evolved into today's legendary Series 700 and 800 wire rope hoists. Other innovations included the first portable electric and lever-operated chain hoists, the development of built-in overload protection devices, air and worm gear hoist technology, and a wide range of

advanced trolleys, bridge components, and accessories.

Shaw-Box experienced tremendous growth after its acquisition in 1964 by Dresser Industries. In 1986, the company was purchased again, by Lift-Tech International. This alliance, together with Lift-Tech's Canadian Operations, has enabled Lift-Tech to strengthen its position as a dominant force in the industry.

Today, Lift-Tech is one of the leading crane and hoist manufacturers in the world, a position maintained

through a commitment to the most rigorous quality standards and continuous innovation and improvement. Lift-Tech products set the industry standard for productivity, efficiency, and durability industry tested and performance-proven for over a century.

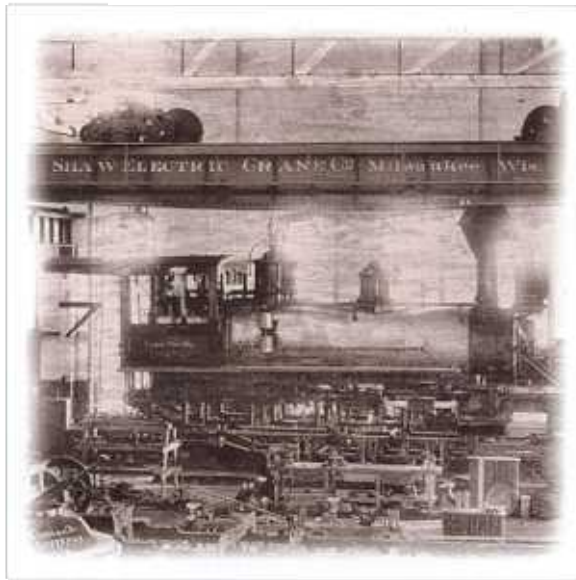

*Crane No. 3 built in 1888 for the Union Pacific Railway and still in use today.*

Recently, the cornerstone of the original Shaw Crane Company building was uncovered on the site where our modern eleven-acre facility still sits. And at last report, Alton Shaw's third crane, purchased by the Union Pacific Railroad in 1888, is still in use today. One-hundred years can tell you a lot about a company.

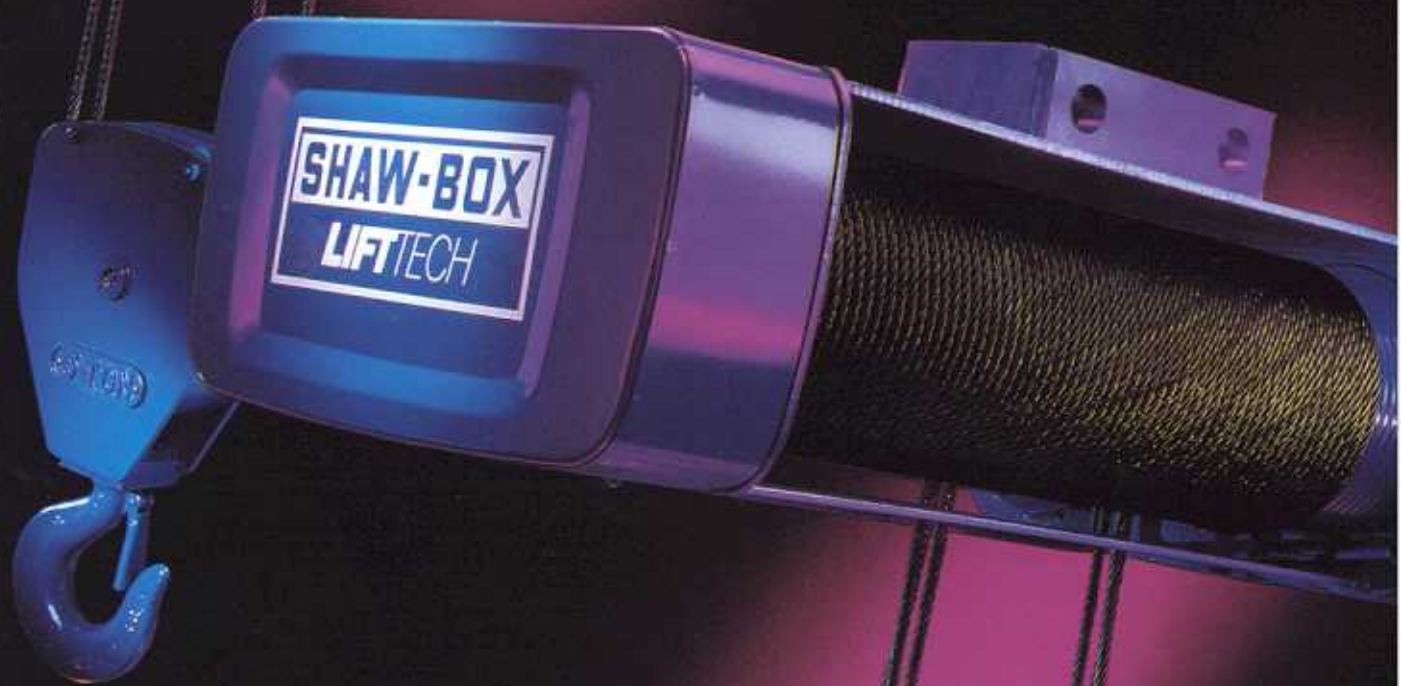
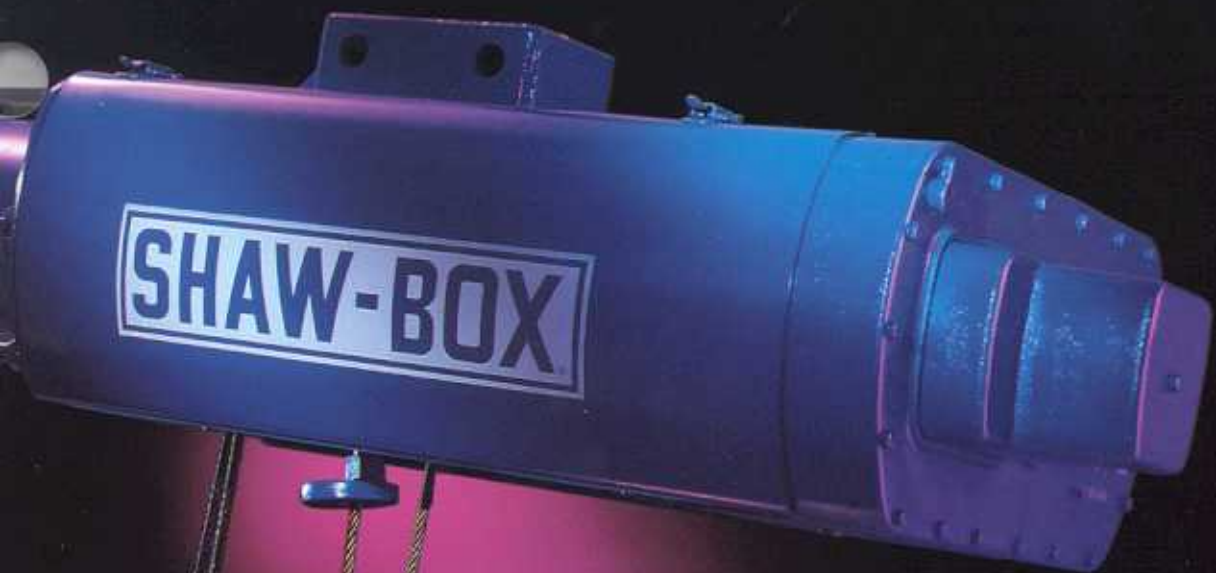

## SERIES 800

SHAW-BOX 800 Series wire rope hoists are ideally suited for virtually any lifting application of up to five tons. Their modular design and versatility provide a wide range of capacities, lifts, hoisting speeds, and control options, making it possible to select the most efficient hoist for the job without wasted capacity or overkill.

The compact design and closer end approaches of the standard 800 Series hoist allows an unusually high hook lift, as compared to many so-called low headroom hoists, without resorting to design compromises. 800 Series hoists maximize hook coverage within an existing facility, reducing or eliminating the need for costly rebuilding or remodeling.

800 Series hoists are available in two basic models: single reeved and true vertical lift, with either air or electric power. The heavy-duty wire rope and drum-type hoist line has a steel mounting lug integral with the one-piece welded frame, and is designed for stationary mounting from an overhead structure, or with any of our monorail trolley options. Standard features of this rugged

hoist line include a heavy welded steel frame, powerful drive motor, totally enclosed oil bath lubricated drive train, and dual brake reliability.

### FEATURES

- 1 Easily accessible control enclosure facilitates maintenance
- 2 D.C. disc motor brake for smooth braking action
- 3 High torque, heavy-duty hoist motor for smooth hoisting action
- 4 Block operated upper limit stop to limit upward hook travel
- 5 Convenient one-handed push-button control for easy operation of all motions
- 6 115 volts at push button for operator safety
- 7 Push-button cable with built-in strain reliever cable as used on single speed hoist applications. (All others use a separate steel strain reliever cable.)
- 8 Improved plow steel pre-formed cable for maximum strength and life
- 9 Full-swiveling, heat-treated forged steel hook with spring loaded latch
- 10 Shrouded lower block to help prevent pinched fingers
- 11 Alloy aluminum gear case and cover is light-weight yet rugged
- 12 Oil level plug permits easy inspection of oil level
- 13 Anti-friction bearings throughout for a long lasting hoist drive train
- 14 Positive action mechanical load lowering control brake, also acts as a part of the hoist holding brake system
- 15 Triple reduction helical/spur gearing operates in oil bath lube for maximum gearing life
- 16 Deep grooved, large diameter rope drum helps prevent rope overwrap for longer wire rope life
- 17 Heavy welded steel frame ensures precise fit for long hoisting machinery life

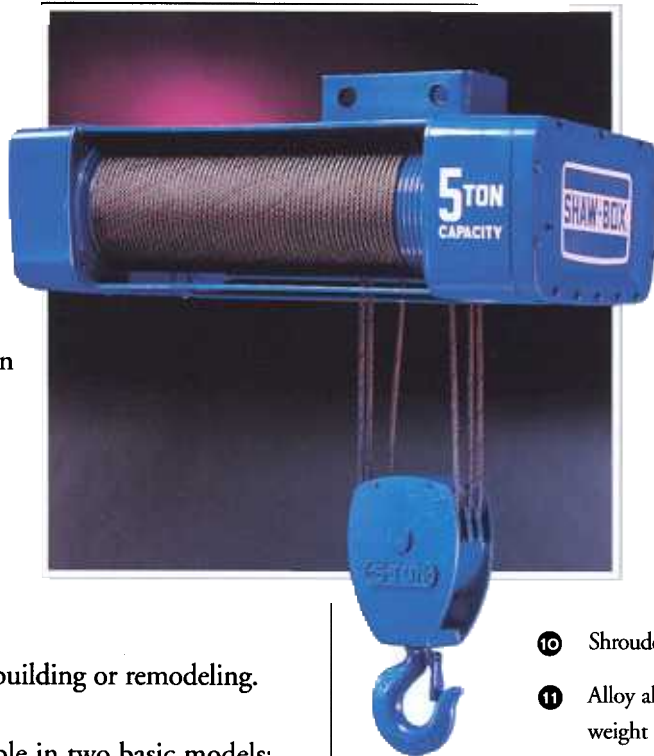

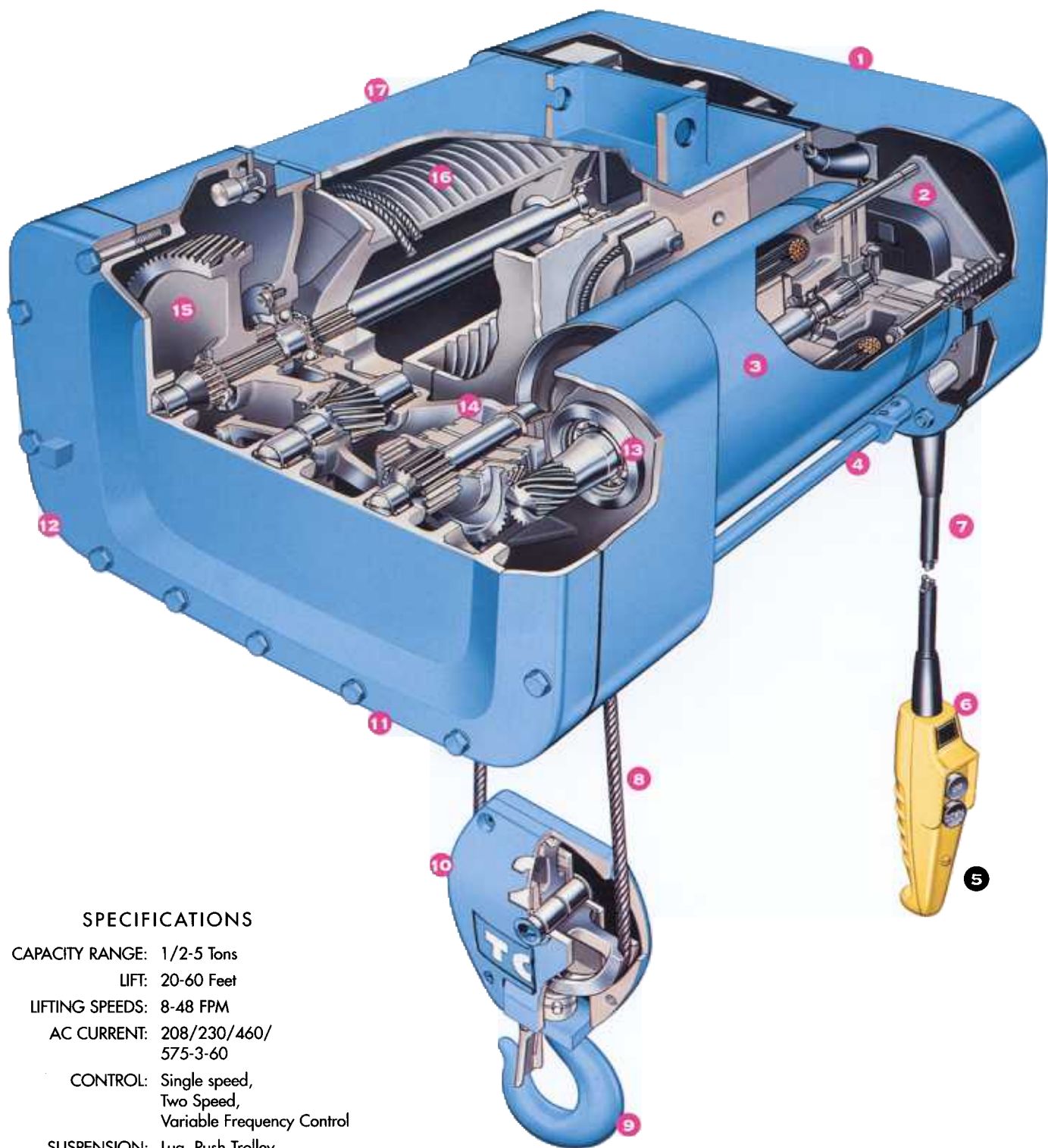

## SPECIFICATIONS

CAPACITY RANGE: 1/2-5 Tons

LIFT: 20-60 Feet

LIFTING SPEEDS: 8-48 FPM

AC CURRENT: 208/230/460/  
575-3-60

CONTROL: Single speed,  
Two Speed,  
Variable Frequency Control

SUSPENSION: Lug, Push Trolley,  
Hand Geared Trolley  
and Motor Driven  
Trolley

## SERIES 700

SHAW-BOX 700 Series wire rope hoists are designed and manufactured for heavy-duty service. This workhorse is built to deliver, day-in and day-out, under tough operating conditions. 700 Series hoists are built to take even the most demanding job cycles in stride, yet can be relied upon to handle your most delicate loads with precision control.

Their compact design, with high hook lift and closer end approaches, maximizes hook coverage within an existing facility, reducing or eliminating the need for costly rebuilding or remodeling. 700 Series hoists achieve an unusually high hook lift, without resorting to design compromises.

This line offers the greatest range of lifting speeds, controls, headroom and mounting options of any hoists on the market today. 700 Series hoists are available in both electric and air powered models. Options include standard and low headroom, deck and base mounted models, with a choice of single reeving or true vertical lift.

The lug is integral with the all-steel, one-piece welded

frame, and is designed for stationary mounting from an overhead structure or with any of our trolley options.

### FEATURES

- 1 One-piece welded steel frame ensures precise fit and long hoisting machinery life
- 2 Alloy aluminum gear case and cover is lightweight yet rugged
- 3 Direct acting D.C. brake solenoid for smooth braking action
- 4 Multiple disc motor brake for long life and maximum braking efficiency
- 5 Bearings supported in an independent gear case spider give a precise fit, and allow removal of the gear case cover without disassembly of the gearing
- 6 Hinged control panel cover permits easy access to the control components
- 7 Improved plow steel preformed wire rope for maximum strength and life
- 8 Full-swiveling, heat-treated forged steel hook with spring loaded latch
- 9 Shrouded lower block to help prevent pinched fingers
- 10 Push-button control pendant for easy one-handed operation
- 11 Rugged, low-maintenance magnetic contactor control
- 12 High torque, heavy-duty hoist motor for smooth load handling
- 13 Watershed and gaskets for tight frame cover seal and protection of internal components
- 14 Integrally welded mounting lug permits various trolley attachment options
- 15 Block operated limit switch limits upward hook travel
- 16 Rope anchor, easily accessible for inspection and maintenance
- 17 Deep grooved, large diameter rope drum helps prevent rope overwrap for longer rope life
- 18 Double reduction helical gearing provides a smooth, quiet drive train
- 19 Positive action mechanical load lowering control brake, also acts as a part of the hoist holding brake system

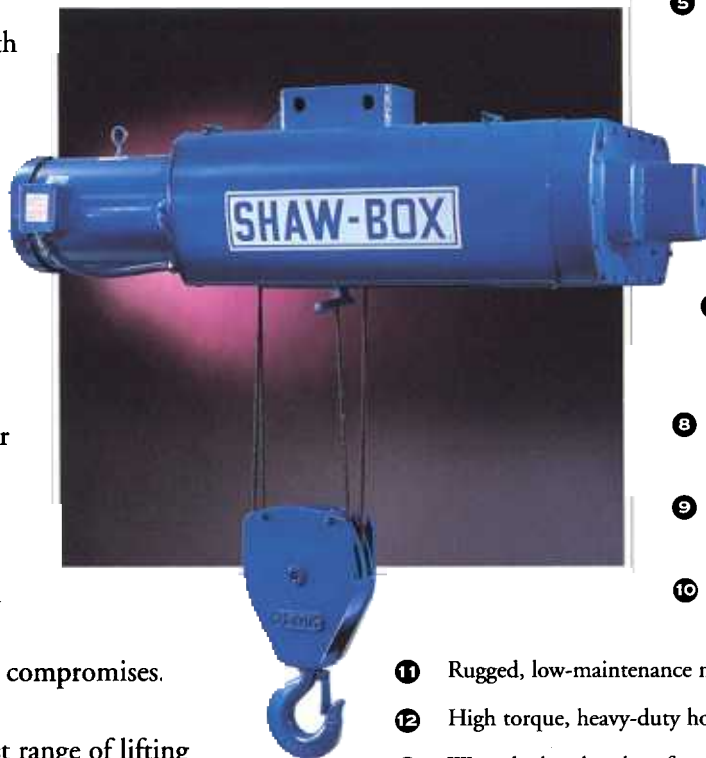

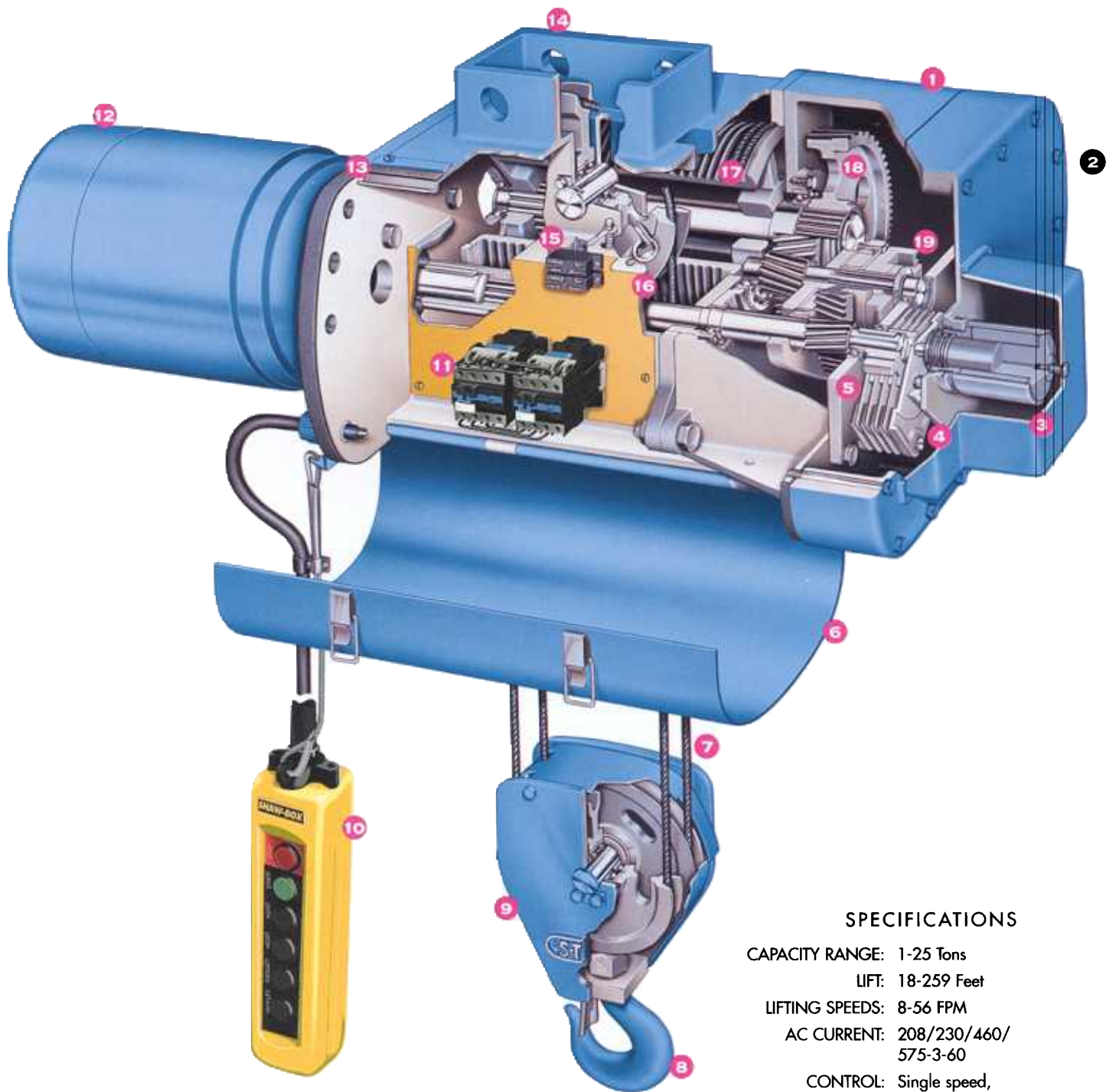

## SPECIFICATIONS

CAPACITY RANGE: 1-25 Tons

LIFT: 18-259 Feet

LIFTING SPEEDS: 8-56 FPM

AC CURRENT: 208/230/460/  
575-3-60

CONTROL: Single speed,  
Two speed,  
Variable Frequency Control

SUSPENSION: Lug, Push Trolley,  
Hand Geared Trolley,  
Motor Driven Trolley,  
Deck and Base

# SERIES 700/800 STANDARD FEATURES

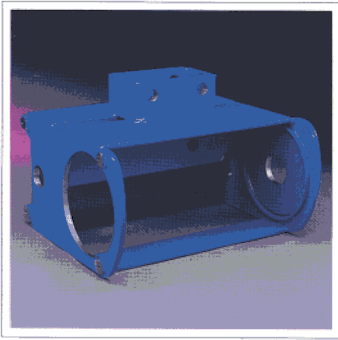

## Welded Steel Frame

*One-piece welded frame, fabricated from rolled steel sections, precision machined for long life and accurate bearing and component alignment. (700 Series frame illustrated)*



## Automatic Load Brake

*Weston self-adjusting type, operates in the oil bath of the hoist gear case for smooth lowering control. Capable of holding the load independent of the hoist motor brake. (700 Series load brake illustrated)*

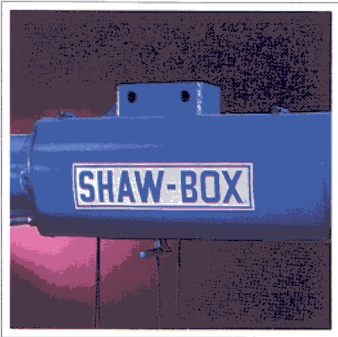

## Lug Suspension

*Permits the hoist to be mounted in a permanent location. (Mounting hardware not included)*

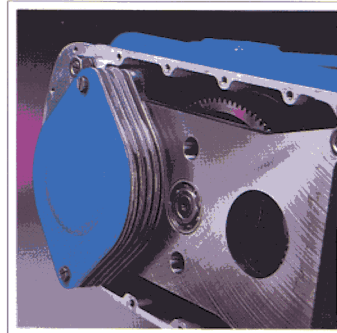

## Hoist Motor Brake

*Short stroke, 150% torque spring-set D.C. rectified disc type brake provides quiet operation and long life. (700 Series multiple disc brake illustrated)*



## Precision Machined Gearing

*For uniform tooth mesh and large contact surface. Operates in a totally enclosed, oil bath lubricated gear case. Gear trains consist of two or three reductions, using helical and/or spur gearing.*

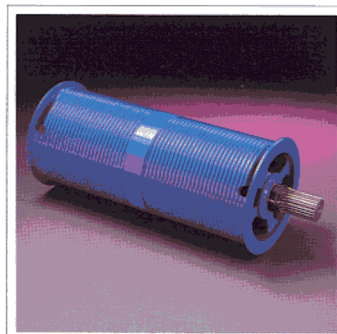

## Machined Rope Drum

*Large diameter, welded construction — deep grooved and precision machined to give maximum rope life. Pictured is a right and left hand grooved true vertical lift drum.*





### **Dead End Rope Anchor**

*Used on single reeved hoists. Easily accessible and part of the one-piece welded frame, it securely anchors the rope compression thimble fitting which is swaged to the rope ends. True vertical lift hoists have both ends of the steel rope dead ended to the rope drum.*

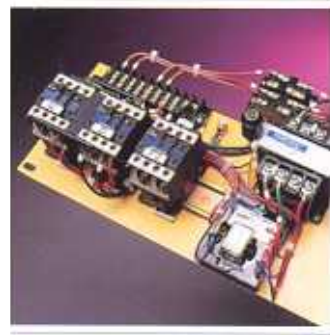

### **Heavy-Duty Controls**

*Designed for a clean, open layout to maximize performance and ease of maintenance. Contactors are oversized for increased life. Panels are housed in a dust resistant compartment designed for easy access and serviceability. (700 Series hoist control illustrated)*



### **Shrouded Lower Block**

*Helps prevent fingers from being pinched between rope and sheaves and prevents dirt buildup. All hooks are provided with spring loaded safety latches.*



### **Hoist Motors**

*High starting torque type, designed specifically for hoisting, with permanently lubricated ball bearings. Motors are totally enclosed, non-ventilated (T.E.N.V.) with class F insulation, and provided with an automatic reset, temperature actuated switch in the windings to provide over current protection.*

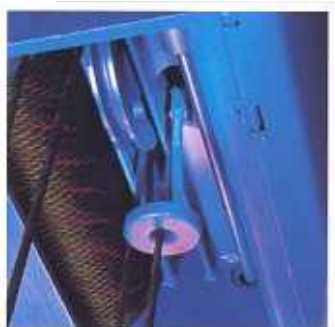

### **Block Operated Limit Switch**

*For additional protection of operator, hoist, and load. Positive acting, momentarily reverses the hoisting motion if lower block drifts too high. (700 Series block limit switch illustrated)*

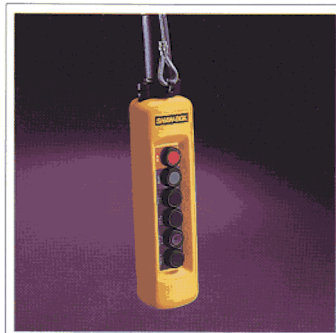

### **Convenient Push-Button Control**

*All motions can be controlled from a convenient, easy to operate push-button control station suspended from the hoist. An external strain reliever cable extends cable life and prevents pulling the control cable from the hoist electrical connection on four button and larger stations.*

# SERIES 700/800 OPTIONAL FEATURES

## Push Trolley Suspension

*Push trolleys are used for mounting hoists on monorails or single girder crane bridges. Operator can quickly move loads by pushing on the load.*



## Deck Mounted Hoists

*Used for applications that require a stationary hoist, or for construction of a top-running trolley.*

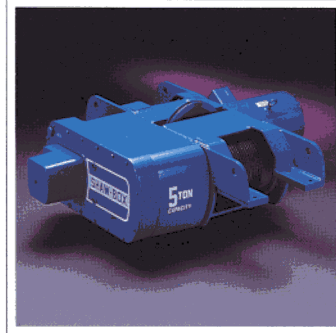

## Hand Geared Trolley Suspension

*For moving loads where accurate spotting is essential or when operator should not touch the load.*



## Top Running Double Girder Trolleys

*Provides a combination of lower headroom, higher hook lift, and closer end approaches. Maximizes hook coverage within existing facility, without costly remodeling or rebuilding.*

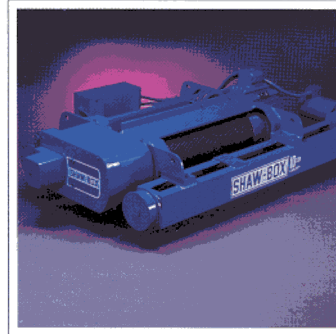

## Motor Driven Trolley Suspension

*Used for moving loads quickly over long distances and where accurate load spotting is needed. Control push buttons can be suspended from hoist or crane bridge.*



## Air Operated Hoists

*Air operation is available for all SHAW-BOX hoists where precise spotting or slow hoisting speeds are required, or where an electrically powered hoist may not be suitable. (Illustrated is an air-piston motor driven 700 Series hoist)*



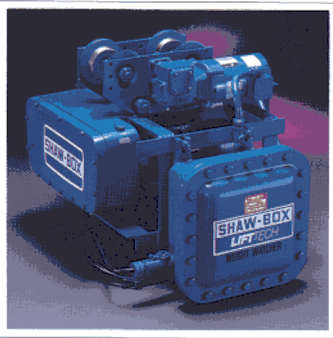

### Explosion Proof Hoists

*In addition to normal operating conditions, all SHAW-BOX hoists may be customized for operation in hazardous locations. Lift-Tech designs each hazardous location hoist to meet or exceed National Electrical Code standards. (800 Series explosion proof hoist illustrated)*



### Variable Frequency Control

*Can be provided for any SHAW-BOX hoist or trolley motion where precise spotting or slow hoisting speeds are required. Available in two, three, or five step control, or two step infinitely variable.*



### Spark Resistant Features

*Bronze and high bronze alloys incorporated in key components such as hooks, lower blocks and wheels, along with stainless steel wire rope, help prevent incidental sparking in hazardous locations.*



### Weight Watcher Overload Control

*A factory set mechanical overload clutch built into the hoist drive train prevents lifting excessive overloads. (700 Series overload clutch illustrated with the cover removed)*



### Special Application Motors

*For special applications such as 60 minute rating, mill and chemical duty, and tropical proofing are available on many hoist models.*

### Other Options:

- Low Headroom Hoists
- Radio Control
- Screw Type Limit Switches
- Power Circuit Limit Switches
- Hot Metal Applications
- Magnet Applications
- Epoxy Paint
- NEMA 12, 3R, or 4 Control Enclosures
- Panel Heaters
- Motor Heaters
- Over Capacity Lift Protection
- Warning Lights/Horns
- Patented Track Wheels
- Double Hook Hoists



## ***SHAW-BOX***<sup>®</sup>

**Yale•Lift-Tech, division of  
Columbus McKinnon Corp.**  
414 West Broadway Avenue  
P.O. Box 769  
Muskegon, MI 49443-0769

Customer Service: **Phone** (800) 742-9269  
**Fax** (800) 742-9270