

Polaris Ranger Quick-Mount 4500lb. Winch Kit



Product Instructions | Part No: 26-3000

Application: Polaris Ranger, verify accessory fitment at Kolpin.com.

Before You Begin: Read these instructions and check to be sure all parts and tools are accounted for. Please retain these installation instructions for future reference and parts ordering information.

Note: You must order power cables kit 85095 separately to connect battery to contactor for models:

2014-2019 RGR Crew XP 900	2017-2018 RGR Crew XP 1000	2015-2018 RGR Crew Diesel	2015-2016 RGR Crew XP 570
---------------------------	----------------------------	---------------------------	---------------------------

Note: If any hardware is missing, do not return to the store. Call us to help, Toll Free 1-877-956-5746.

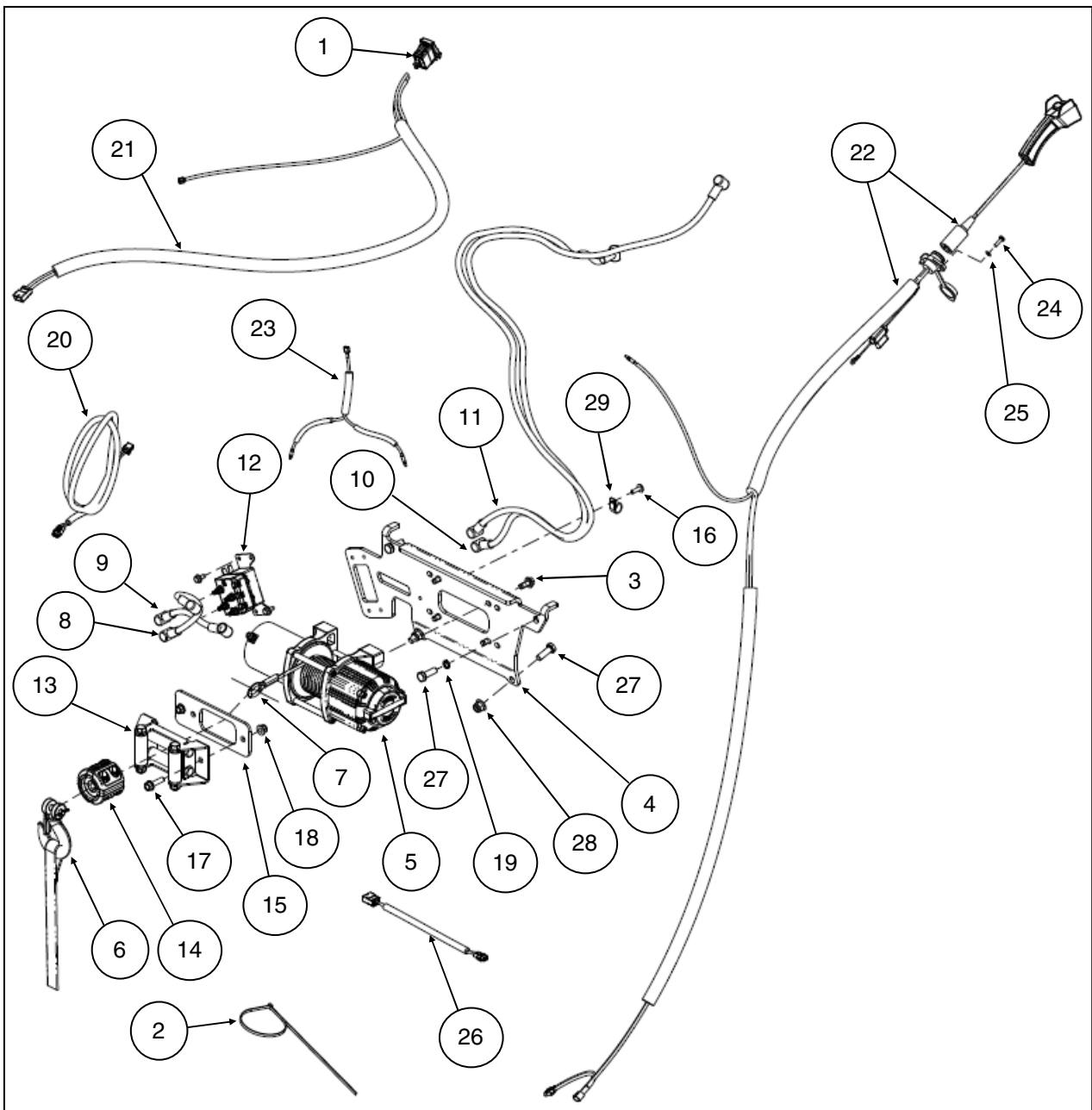

This Kit includes:

Item	Qty	Part Description	Part Number
1	1	Dash Switch, Panel Mount	4015688
2	10	Cable Ties, Nylon	-
3	4	Hex Flange Screw, Zinc Plated, M8 x 1.25 - 20mm LG	-
4	1	Mounting Bracket	25-3400
5	1	Winch - Kolpin, 4500lb.	25-9450R
6	1	Hook, Winch Latch	RPR0108
7	1	Winch Cable, Synthetic - 4500lb.	85064
8	1	Winch Connection Cable, Yellow 6 GA (120mm)	-
9	1	Winch Connection Cable, Blue 6 GA (80mm)	-
10	1	Power Connection Cable, Black 6 GA (1728mm)	-
11	1	Power Connection Cable, Red 6 GA (1651mm)	-
12	1	Contactor, Solenoid, 12V	85068
13	1	Roller Fairlead	85069
14	1	Rubber Winch Stopper	85080
15	1	Fairlead Adapter Plate	CYC6425
16	3	Hex Flange Tap Screw, Zinc Plated, M6 x 1.0 - 15mm LG	7518513
17	3	Hex Flange Screw, Zinc Plated, M8 x 1.25 - 30mm LG	7520234
18	3	Hex Flange Locknut, Zinc Plated, M8 x 1.25	7547317
19	2	Spring Lock Washer, Zinc Plated, M10	-
20	1	Ranger Vehicle Dash Switch-Contactor Extension Harness	-
21	1	Ranger Vehicle Dash Switch Pigtail Harness	-
22	1	Ranger Vehicle Corded Remote Switch & Harness	-
23	1	Ranger Vehicle Accessory Power Splitter Harness	-
24	2	Pan Head Screw, Zinc Plated, #10 x 0.75" LG	-
25	2	Flat Washer, Zinc Plated, M5	-
26	1	Ranger Vehicle Contactor Pigtail Harness	-
27	4	Hex Screw, Zinc Plated, M10 x 1.5 - 30mm LG	-
28	2	Hex Flange Locknut, Zinc Plated, M10 - 1.5	-
29	1	Wire Clamp, Black Vinyl Coat Metal, 3/4"	-
30	1	Instruction Guide (not shown)	-
-	-	Service Free Spool Handle Knob (not included in kit)	85072

Tools Required:

- Safety Glasses
- Socket Set, Metric
- Wrench Set, Metric
- Drill or cutting tools for plastic
- Socket Set, Torx Bit
- Torque Wrench
- Pliers
- 1" Hole Saw or Drill Bit
- Electric Drill or Dremel tool

Assembly Time: Approximately 30 minutes

Note: The 26-3000 kit comes mostly assembled from the factory. Some assembly is required.

Older Generation Ranger / Newer Generation Ranger Note: The 26-3000 kit will fit the older generation and newer generation Ranger vehicles. The instructions will guide through commonly shared steps and model-specific steps where noted.

Important: Your Kolpin Ranger Quick-Mount Winch Kit is exclusively designed for your vehicle. Please read the installation instructions thoroughly before beginning. Installation is easier if the vehicle is clean and free of debris. For your safety, and to ensure a satisfactory installation, perform all installation steps correctly in the sequence shown. Additional time may be required to accommodate other installed accessories.

RANGER PREPARATION:

1. Shift vehicle transmission into "PARK". Turn ignition key to "OFF" position and remove from vehicle ignition.
2. Flip up and/or remove passenger (or right rear passenger) seat bottom (also flip-up drivers set for newer gen) and remove under seat storage compartment tray by pulling it in upward direction.
3. Disconnect black negative (-) cable from battery first, then disconnect red positive (+) cable from battery.

⚠ WARNING ⚠

ALWAYS disconnect black negative (-) cable from battery **FIRST**. Failure to do so will result in high current electrical arc, and may result in battery explosion if tool touches grounded frame. Death or serious injury may occur.

4. Remove the hood from vehicle to gain access.
5. **Newer gen Ranger:** Remove lower grille by carefully depressing two tabs at top of grille, tip grille outward. Then lift grille out of two lower side tabs in upper fascia as shown. (See illustration 1-1). **Note, bumper hidden for clarity.**
6. Remove the front bumper for your vehicle model by removing four screws (two upper and two lower) and four nuts (two upper and two lower) as shown. (See illustrations 1-2 and 1-3). **Note, the bumper is heavy, provide adequate support before removing final screws. Additional note, screws pass through bumper support brackets, these brackets will be referenced in step 12.**

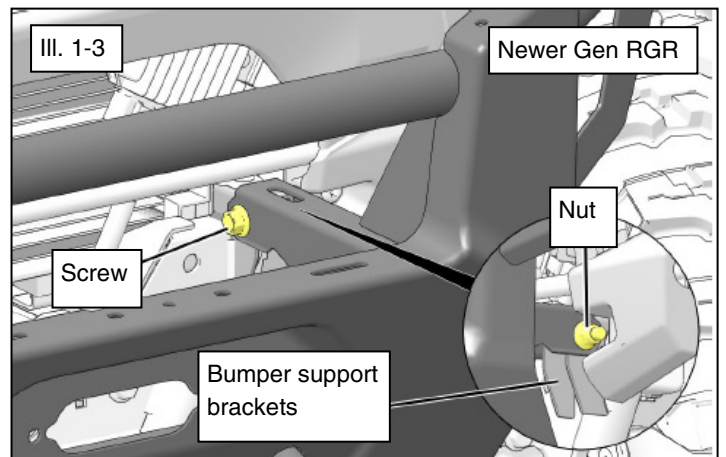
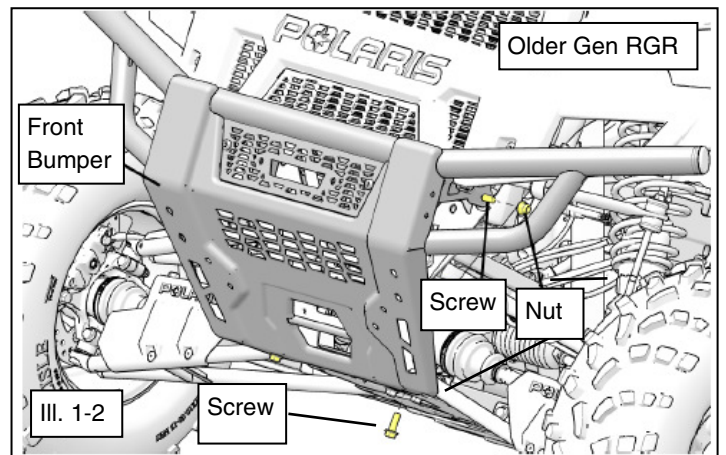
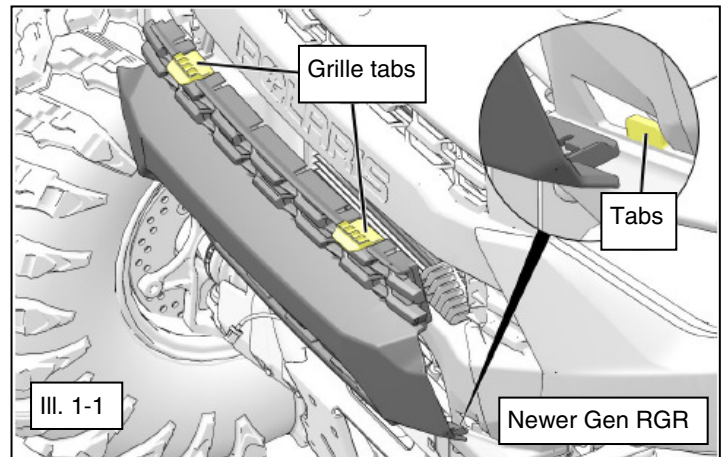

RANGER PREPARATION (continued):

7. **Older gen Ranger:** Remove four push dart fasteners from center floor section as shown and retain for re-install later. (See illustration 1-4).
8. **Newer gen Ranger:** Remove upper dash cupholder by removing two push pin rivets as shown, then sliding cupholder rearward. Retain rivets for reinstall later. (See illustration 1-5).
9. **Older gen Ranger:** Remove upper dash panel by removing four push pin rivets as shown. Retain rivets for reinstall later. (See illustration 1-6).
10. Remove the Ranger winch assembly from the packaging.

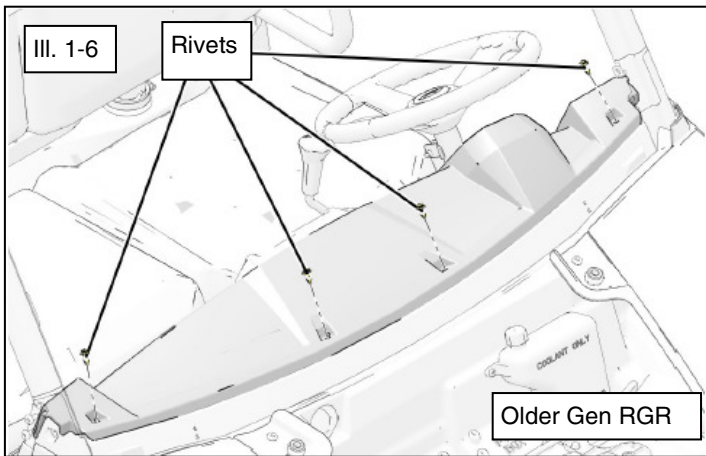
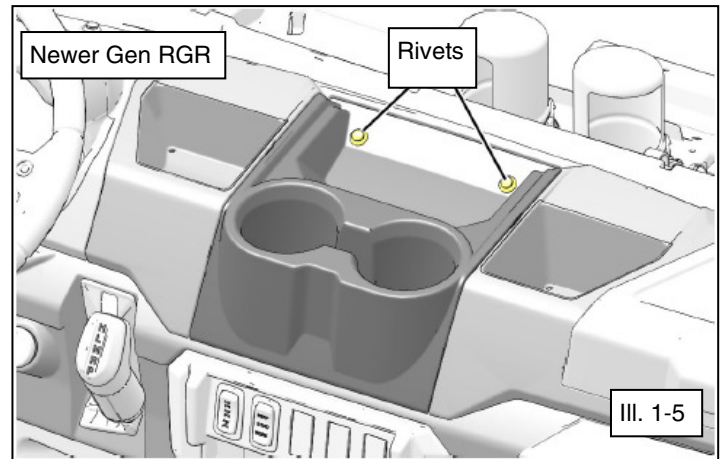
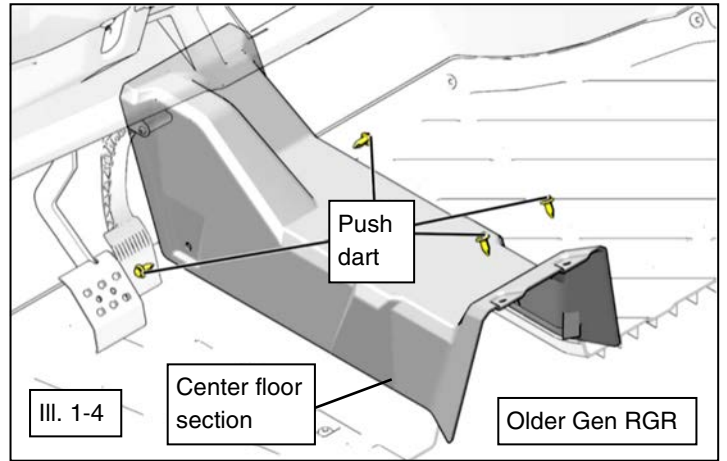

RANGER WINCH INSTALLATION:

NOTE: See the *Electrical Connections Reference Guide* section of the instruction manual for detailed photos of each part and their respective connections.

11. Locate the red and black wires (items #10 and #11) on the winch assembly. If they are secured in a bundle with plastic tie, cut the tie to allow the cables to be routed through the front frame window shown below.

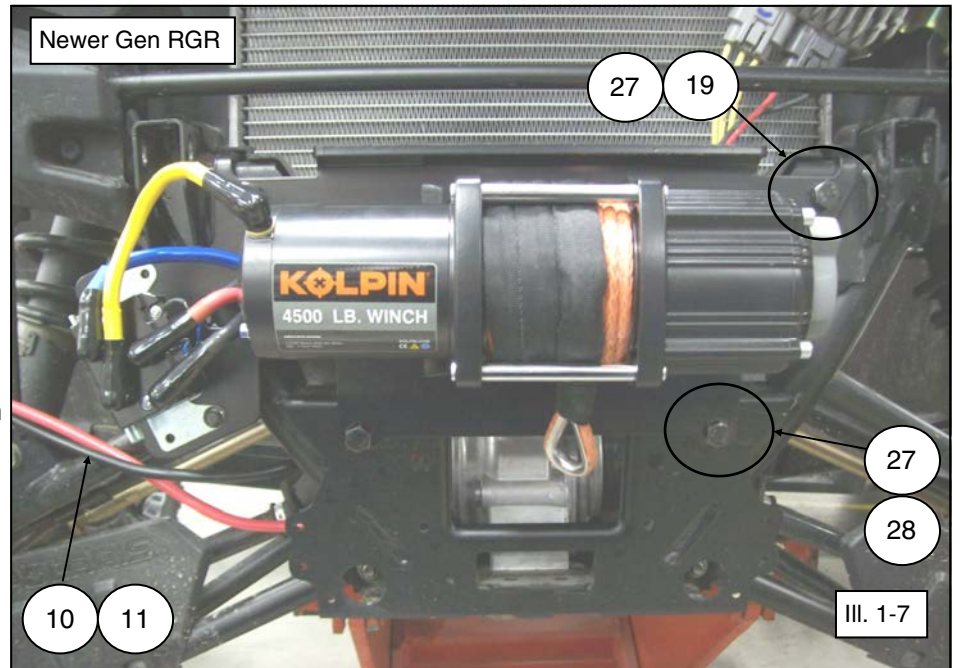

**RANGER WINCH INSTALLATION
(continued):**

12. Install by hanging the hooks of the winch assembly on vehicle front support structure, centered between two bumper support brackets as noted in previous step 6. (See illustrations 1-7 and 1-8).

13. At UPPER fasteners holes, loosely install M10 screws (item #27) through lock washers (item #19) and then REARWARD through winch assembly into vehicle support structure. Do not tighten at this step.

14. At LOWER fastener holes, install M10 screws (item #27) FORWARD through vehicle front support structure and winch assembly, then secure with M10 locknuts (item #28).

15. Tighten all M10 fasteners to specification.

 = T
10MM FASTENER TORQUE: 34 ft. lbs. (46 Nm)

16. Re-install lower grille if removed.

17. Using OEM hardware, re-install front bumper.

18. Tighten fasteners to specification.

 = T
FRONT BUMPER FASTENER TORQUE: 40 ft. lbs. (50 Nm)

19. Assemble the mounting bracket to the front bumper using the M8 bolts (item #17) as shown. Insert the bolts thru the bracket and bumper and then place the fairlead adapter plate (item #15) and roller fairlead (item #13) onto the threads. Fasten with M8 locknuts (item #18). (See illustrations 1-9 and 1-10). **Note, make sure that the bigger roller is positioned on the bottom.**

20. Tighten the M8 fasteners to torque specification.

21. Route the synthetic rope cable thru the roller fairlead and attach the clevis hook (item #6) and rubber bumper (item #14) onto the thimble end as shown. (See illustration 1-9).

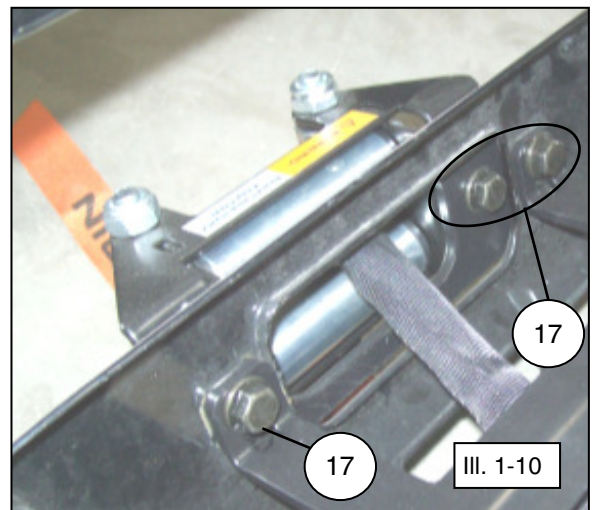
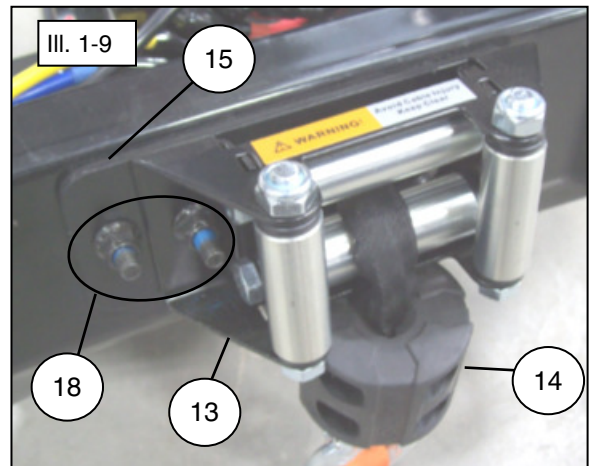
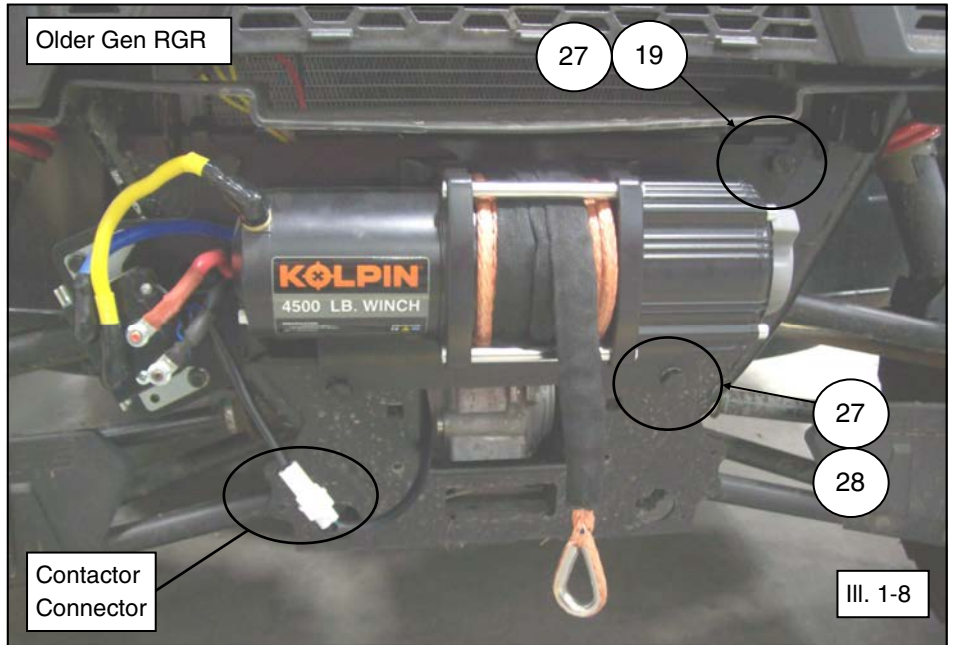

 = T
8MM FASTENER TORQUE: 17 ft. lbs. (23 Nm)

RANGER POWER CABLES INSTALLATION:

22. Route red and black power cables (items #10 and #11) from winch assembly up through front gearcase area and back towards battery (up along radiator towards busbar under hood for newer gen) following the vehicle main wire harness as shown. Use cable ties (item #2) to secure the harness as shown. (See illustrations 1-11, 1-12, 1-13 and 1-14). **Note, do not connect cables to battery and bus bar terminals at this time.**

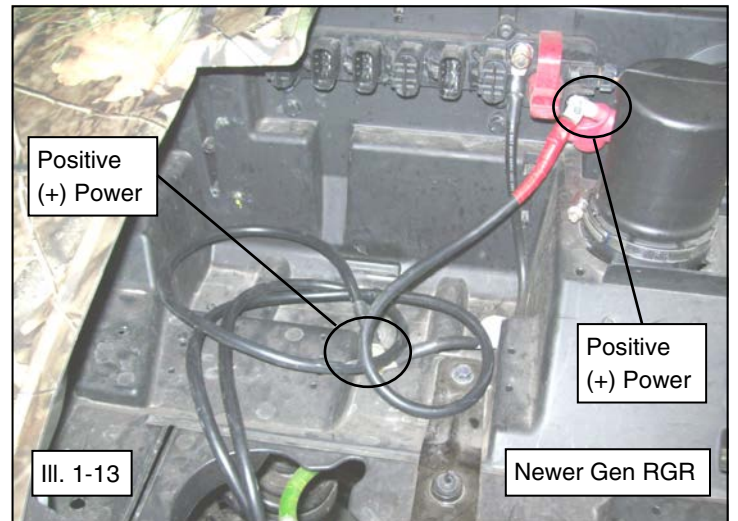
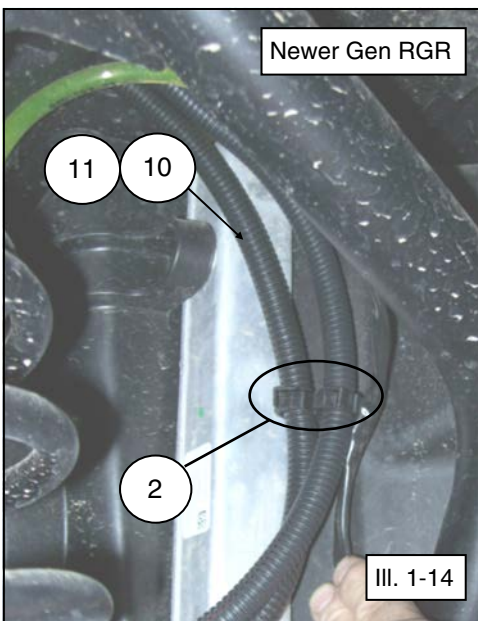
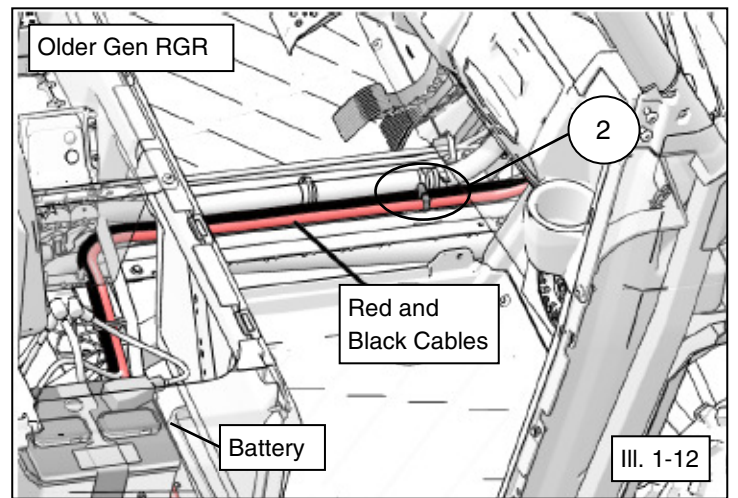
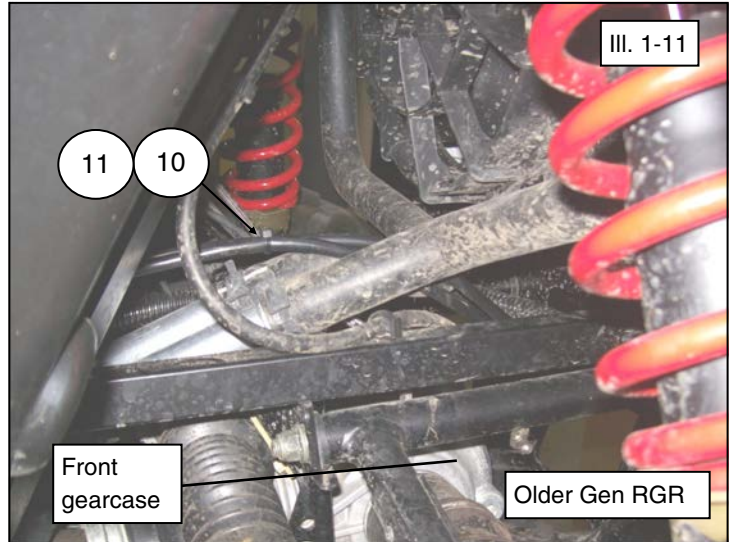

**RANGER CORDED REMOTE SWITCH
INSTALLATION:**

NOTE: See the *Electrical Connections Reference Guide* section of the instruction manual for detailed photos of each part and their respective connections.

23. Install remote switch on vehicle dash. From inside the cab, drill a 1" (25mm) diameter hole into the dash storage panel as shown, centered between dots embossed on dash. Drill two holes for screws with 1/4" (5mm) drill bit over embossed dots as shown in figures. (See illustrations 1-15 and 1-16).

24. Feed the corded remote harness thru the large hole and install the dash socket (item #22) using the supplied M5 flat washers (item #25) and small screws (item #24) into the dash as shown. (See illustration 1-17).

25. Torque screws to the specification listed, being careful not to overtighten.

 = T
SWITCH SCREW FASTENER TORQUE: 2 ft. lbs. (2.7 Nm)

26. Locate the area where the wire harness will pass thru the dash wall. Route the supplied Ranger vehicle harness (item #22) through the firewall (through the rubber grommet) towards front gearcase area. (See illustration 1-18 and 1-20).

27. **Older gen Ranger:** The firewall location is a round area of 1-11/16" (43mm) diameter that must be removed by cutting along the perimeter scribe line with a sharp tool. Remove the round plastic cut out as shown in figure. Install the grommet (PN 5414440). Vehicle hardware kit contains the grommet. Cut the grommet (PN 5414440) to allow wire harness through. Attach the supplied red fused wire from harness kit (item #22) to the 12V accessory keyed power terminal post under the hood as shown. Then connect red wires together using the accessory splitter (item #23). (See illustration 1-18). **Note, the power accessory splitter harness will also be used to connect to the Dash Mount switch.**

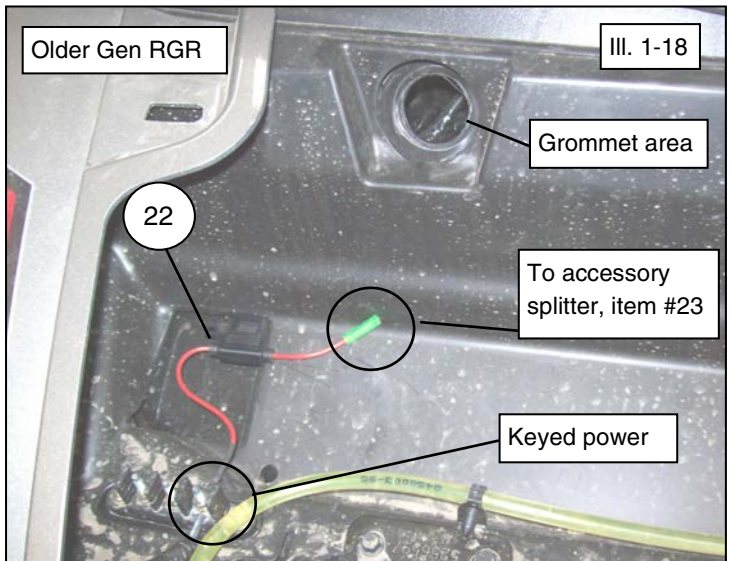
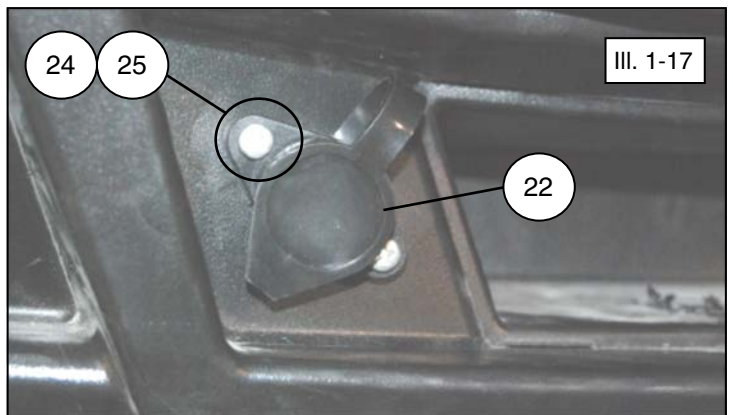
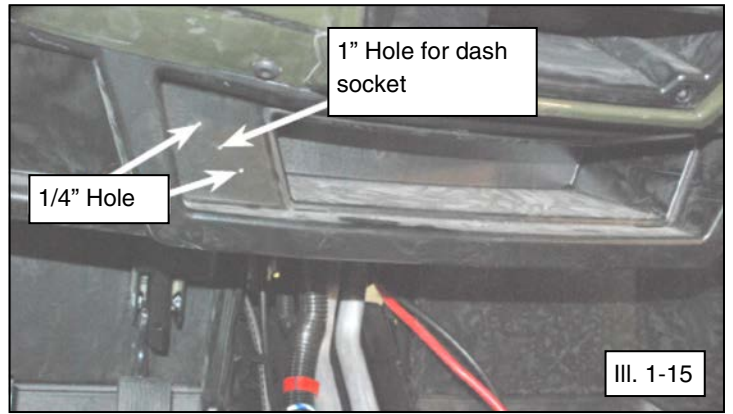

**RANGER CORDED REMOTE SWITCH
INSTALLATION (continued):**

28. *Newer gen Ranger:* From inside cab, locate dash wire bundle from under the removed cup holder piece. Remove the dummy cap for the vehicle winch control connector. Connect the Ranger Vehicle Dash Switch Pigtail Harness (item #21) into the main vehicle harness as shown. Then connect red wire from pigtail (item #21) to corded remote harness (item #22). (See illustrations 1-19, 1-20, 1-21). **Note, the dash switch pigtail connects to vehicle 12V accessory keyed power and will also be used for the dash switch control.**

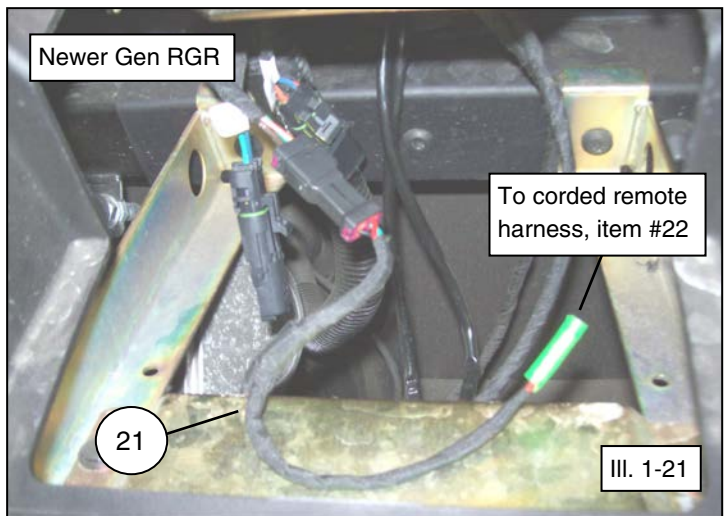
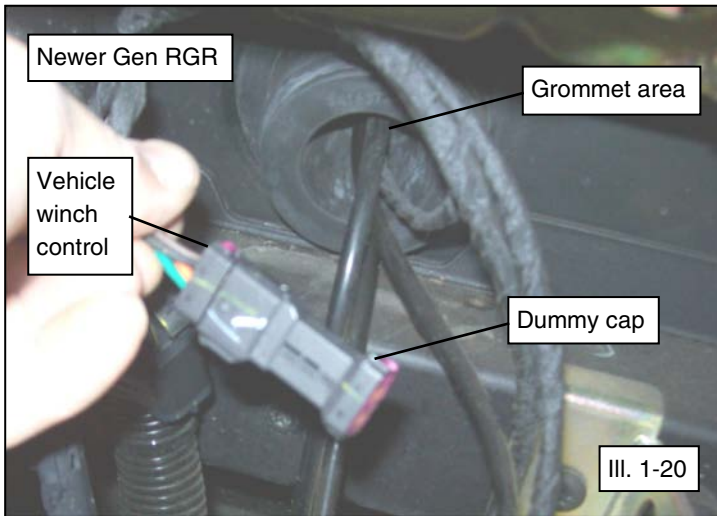
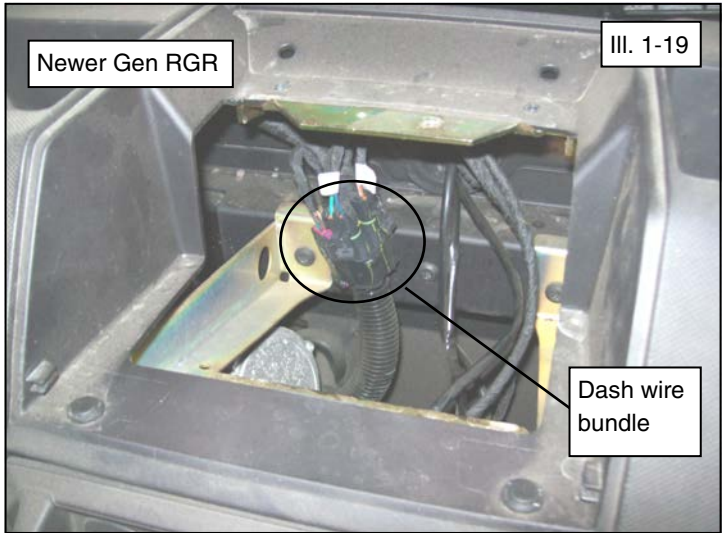

29. Connect the white harness connector to the winch contactor connector as shown. Access is gained by reaching thru the front bumper and thru the front gearcase access window to reach white contactor connector. Use cable ties (item #2) to secure the harnesses. (See illustration 1-8).

RANGER DASH MOUNT SWITCH INSTALLATION:

NOTE: See the Electrical Connections Reference Guide section of the instruction manual for detailed photos of each part and their respective connections.

30. Install dash mount switch (item #1) to desired location on your dash. Check to see if your vehicle has marked rectangular predefined switch location and trim area out. If not, use the cut-out dimensions shown below to cut-out the switch location in your desired location. (See illustrations 1-22 and 1-23).

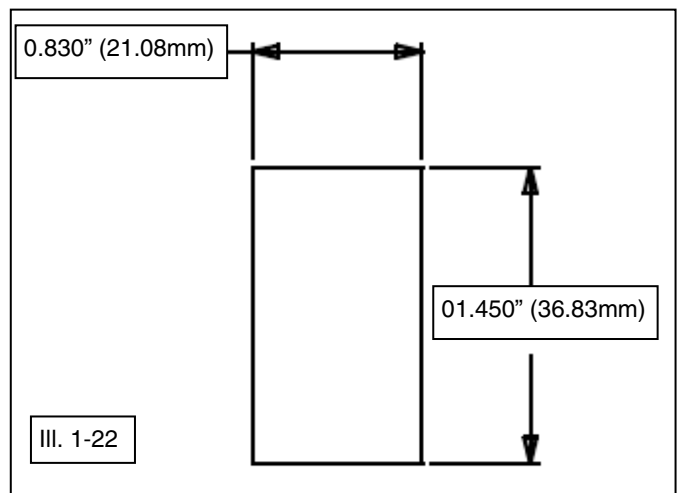

RANGER DASH MOUNT SWITCH INSTALLATION (continued):

31. Connect the dash mount switch (item #1) to the Ranger Vehicle Dash Switch Harness (item #21). Connect green wire to the “Out” pin, red wire to the middle pin and black wire to the “In” pin as shown. (See illustration 1-24).
32. Insert the dash switch harness and switch assembly thru the panel hole as shown. The switch will clip into the dash panel. (See illustration 1-25).
33. **Older gen Ranger:** From inside the dash, connect the red lead wire from dash switch harness into the Accessory Power Splitter Harness (item #23) red wire receptacle, as mentioned in previous step 27. Then route and connect the Ranger Vehicle Dash Switch-Contactor Extension Harness (item #20) into the pigtail (item #21) and the white connector will plug into the winch contactor. (See illustrations 1-8 and 1-26).

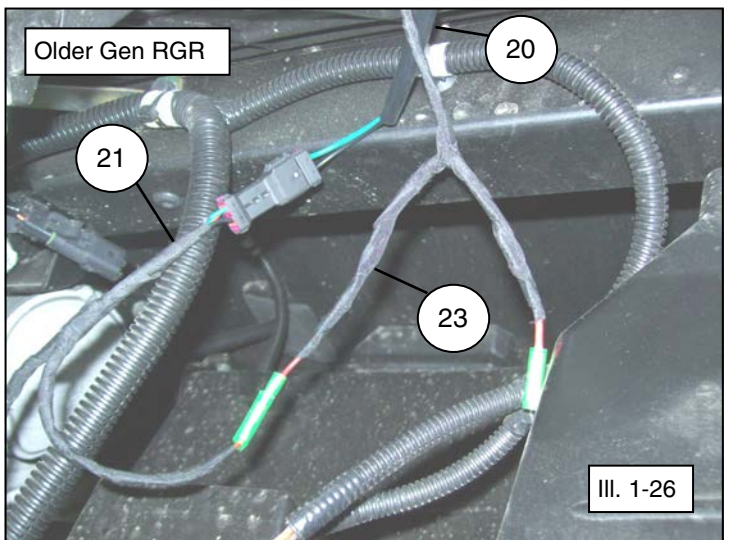
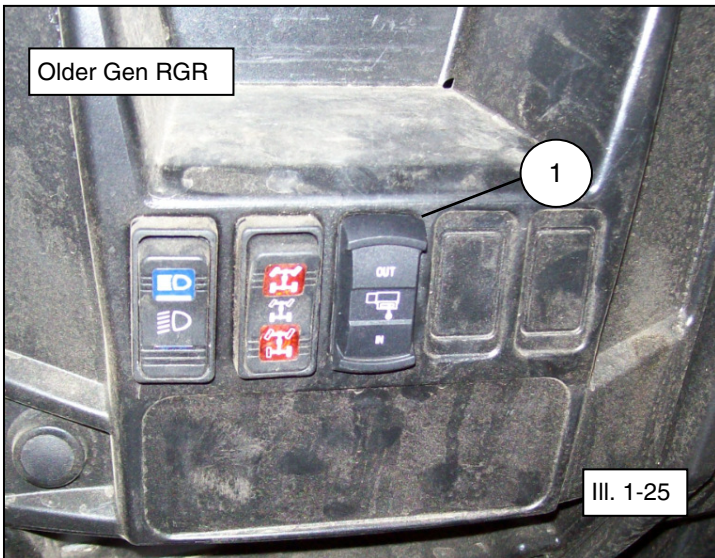
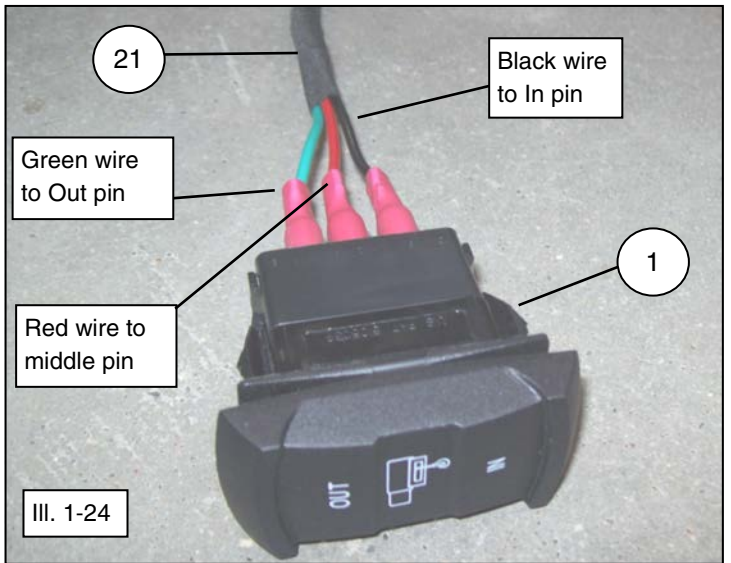

RANGER DASH MOUNT SWITCH INSTALLATION (continued):

34. **Newer gen Ranger:** From the winch contactor, connect the corded remote switch white connector pigtail (item #22) into the Ranger Vehicle Contactor Pigtail harness white connector (item #26). Then connect the pigtail into the main vehicle harness located near front gearcase. (See illustrations 1-27 and 1-28).

RANGER FINAL INSPECTION:

35. Confirm that all wiring is correct.
36. Confirm that there are no exposed wires or terminals.
37. All loose wires need to be wrapped tight, and secured away from moving parts and heat sources.

RANGER REINSTALLATION:

38. Re-install the dash panel and center floor section if removed previously.
39. Reconnect the main vehicle power cables and the winch power red (positive) and black (negative) cables to battery terminals at this time using original hardware.
40. Re-install the seat compartment and seats.
41. Re-install the front hood.
42. Connect the corded winch remote switch (item #22) to the dash socket.
43. With vehicle key in the ON position, check winch for proper operation.

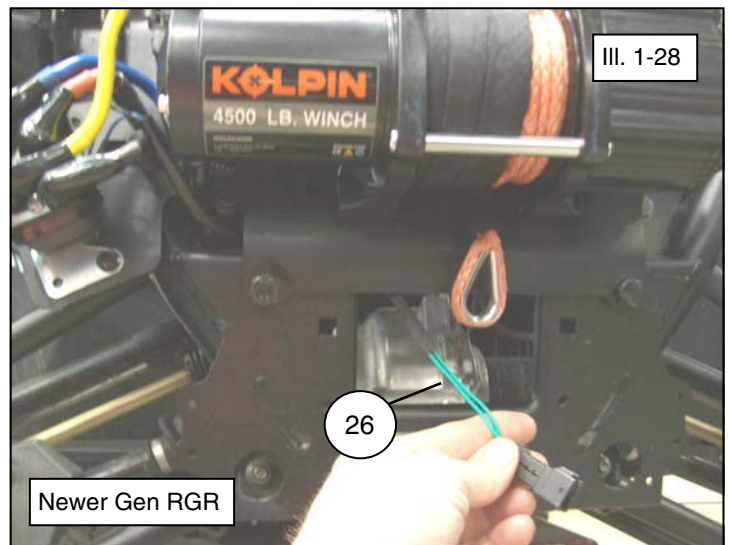
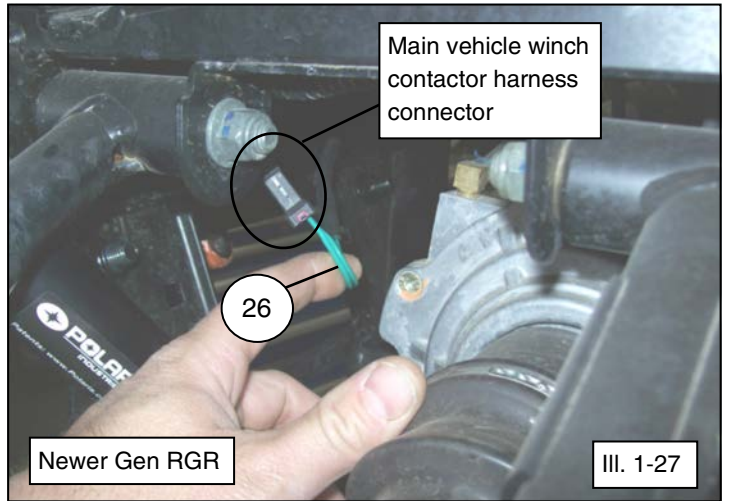

GEAR SELECTION:

Your winch is equipped with two different gear settings: "FREE" and "LOCK".

1. FREE: Used to rapidly extend the rope/cable (faster than when in the "LOCK" position).
2. LOCK: Used to recover the rope/cable.

To shift between FREE and LOCK relieve all tension from the rope/cable, then rotate gear selector knob (located on end of winch) clockwise to engage LOCK mode, or counter-clockwise to engage FREE mode.

Note, see kit contents for replacement knob PN.

SWITCH OPERATION:

When properly installed, the handlebar switch allows you to operate the winch while seated on the vehicle. Proper switch operation is shown. (See illustration 1-30).

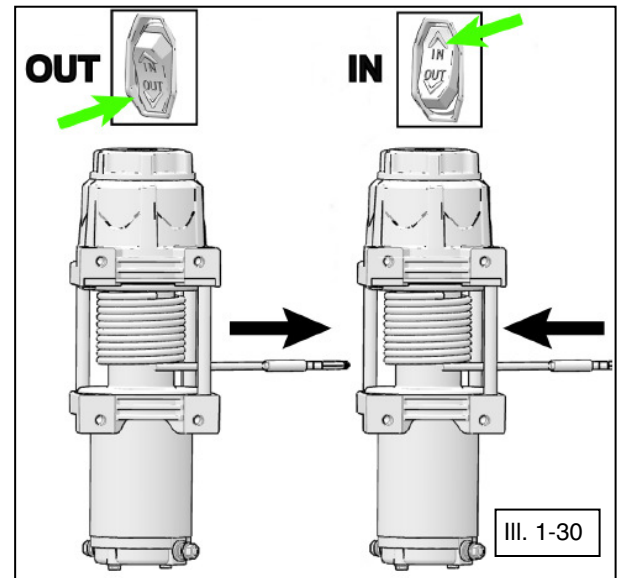
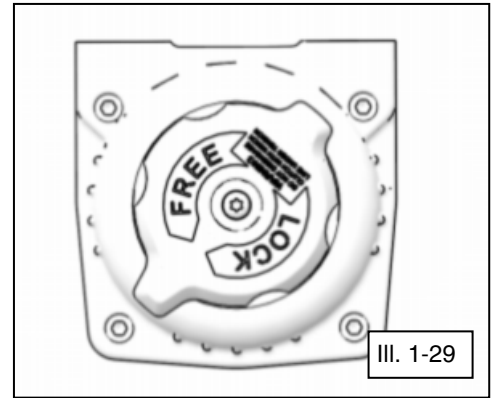

For additional assistance, please contact Kolpin customer service department at (877) 956-5746 or (763) 478-5800 or email customerservice@kolpin.com

Five Year Mechanical Limited Warranty and Three Year Electrical Limited Warranty

For the period of five (5) years from the purchase date, Kolpin will replace for the original purchaser, free of charge, any mechanical part or mechanical parts found upon examination by Kolpin to be defective in material, workmanship, or both. For the period of three (3) years from the purchase date, Kolpin will replace for the original purchaser, free of charge, any electrical part or electrical parts found upon examination by Kolpin to be defective in material, workmanship, or both.

All transportation costs incurred submitting product to Kolpin for warranty consideration must be borne by the purchaser. If Kolpin determines that the product must be returned to the factory for credit, please call 1-877-956-5746 for a Return Merchandise Authorization (RMA) number and shipping instructions.

This warranty does not apply to parts that have been damaged by accident, alteration, abuse, improper maintenance, normal wear, or other causes beyond the manufacturer's control. In order to protect you and your ATV, certain parts of the winch/plow system and/or hardware are designed to fail when the equipment is over-stressed. Parts that are lost due to loosening and improper maintenance are not covered under warranty. This warranty does not cover removal or reinstallation labor fees of the winch/plow system and related components.

Peripheral products such as engines, electric motors, and actuators may carry an original manufacturer's warranty. Most hardware is general in nature and is easily obtained locally. Be sure to replace with minimum metric class 8.8 specification.

Kolpin Outdoors, Inc.

www.kolpin.com

TROUBLESHOOTING

If your winch is not functioning properly, below is a short guide that can help you diagnose and correct the problem.

Symptom	Possible Causes	Recommended Solution
Winch will not operate	Contactors not receiving power	Turn vehicle key on.
	Connections between components not in proper order	Check connections. Connect wired handlebar switch connection from vehicle main wire harness directly to contactor to make sure a direct connection will operate the winch. If connections are not in the order shown in the pictures in the last page, the whole system may not function or only certain parts of it will function.
	Loose battery cable connections	Tighten nuts on all cable connections.
	Keyed power circuit (orange wires) not properly powered	Check fusebox for 10A accessory circuit. Check voltage in certain places, especially orange wires coming out of the main harness by the steering post.
	Contactors malfunctioning	Tap contactor to loosen contacts. Apply 12 volts to coil terminals directly. A clicking indicates proper activation.
	Defective switch assembly	Replace switch assembly.
	Defective motor	Check for voltage at armature port with switch pressed. If voltage is present, replace winch assembly.
	Nested and bounded cable within winch assembly	Move free spool knob to the "free spool" position. Manually pull cable out of winch until end is met and then re-spool cable back into winch.
	Water has entered motor	Allow to drain and dry. Run in short bursts without load until completely dry.
Winch makes noise but rope does not move	Contactors powered, but not winch	If you can hear a clicking sound when you press the winch control but the winch does not make any sounds, check the connections between the winch and the contactor.
	Winch not in proper gear	Move free spool knob to the "locked spool" position, then recheck. If problem persists, a qualified technician needs to check and repair.
Winch operates too slowly	Winch improperly loaded	Check that the winch is clear and the rope is not bound up and that there is no load pulling on the rope.
	Insufficient current or voltage	The battery is weak, recharge. Run winch with vehicle motor running (battery should have a strong charge).
	Loose or corroded battery cable connections	Clean, tighten, or replace.
Winch overheating	Winch running time too long	Allow winch to cool down periodically.
Winch operates in one direction only	Defective or stuck contactor	Tap contactor to loosen contacts.
		Repair or replace contactor.
	Defective switch assembly	Replace switch assembly.
	Defective brake assembly	Replace winch assembly.

Note: If any hardware is missing, do not return to the store. Call us to help, Toll Free 1-877-956-5746.

NOTE

For further technical support, contact our help line at 1-877-956-5746.

ELECTRICAL CONNECTION REFERENCE GUIDE:

2018 & Newer Ranger 1000 Equipped with Pulse Bar:

Winch with Roller Fairlead, Dash Switch and Corded Remote Switch

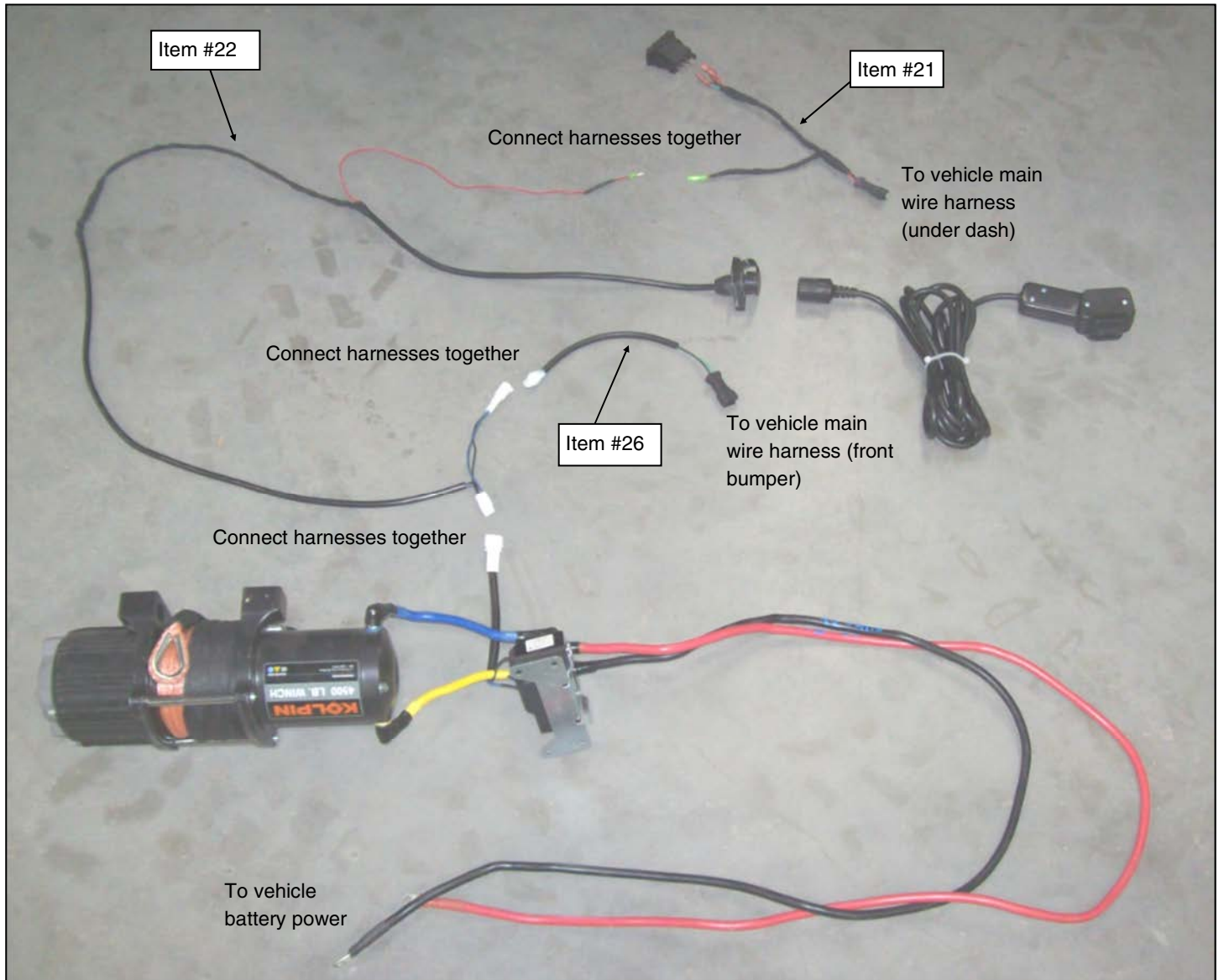

ELECTRICAL CONNECTION REFERENCE GUIDE (continued):

2018 & Newer Ranger 1000 Equipped with Pulse Bar:

Winch with Roller Fairlead and Dash Switch

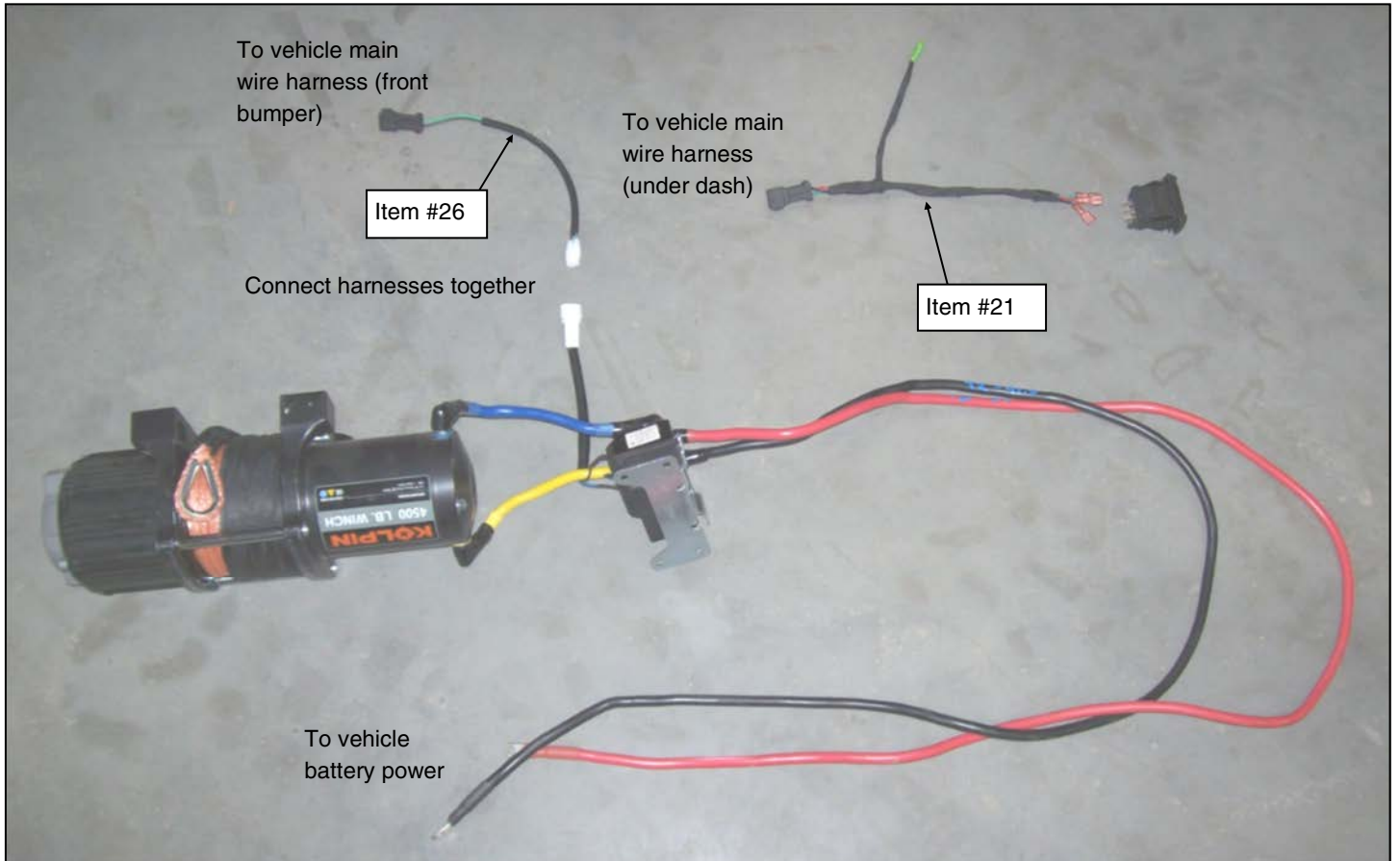

ELECTRICAL CONNECTION REFERENCE GUIDE (continued):

2018 & Newer Ranger 1000 Equipped with Pulse Bar:
Winch with Roller Fairlead and Corded Remote Switch

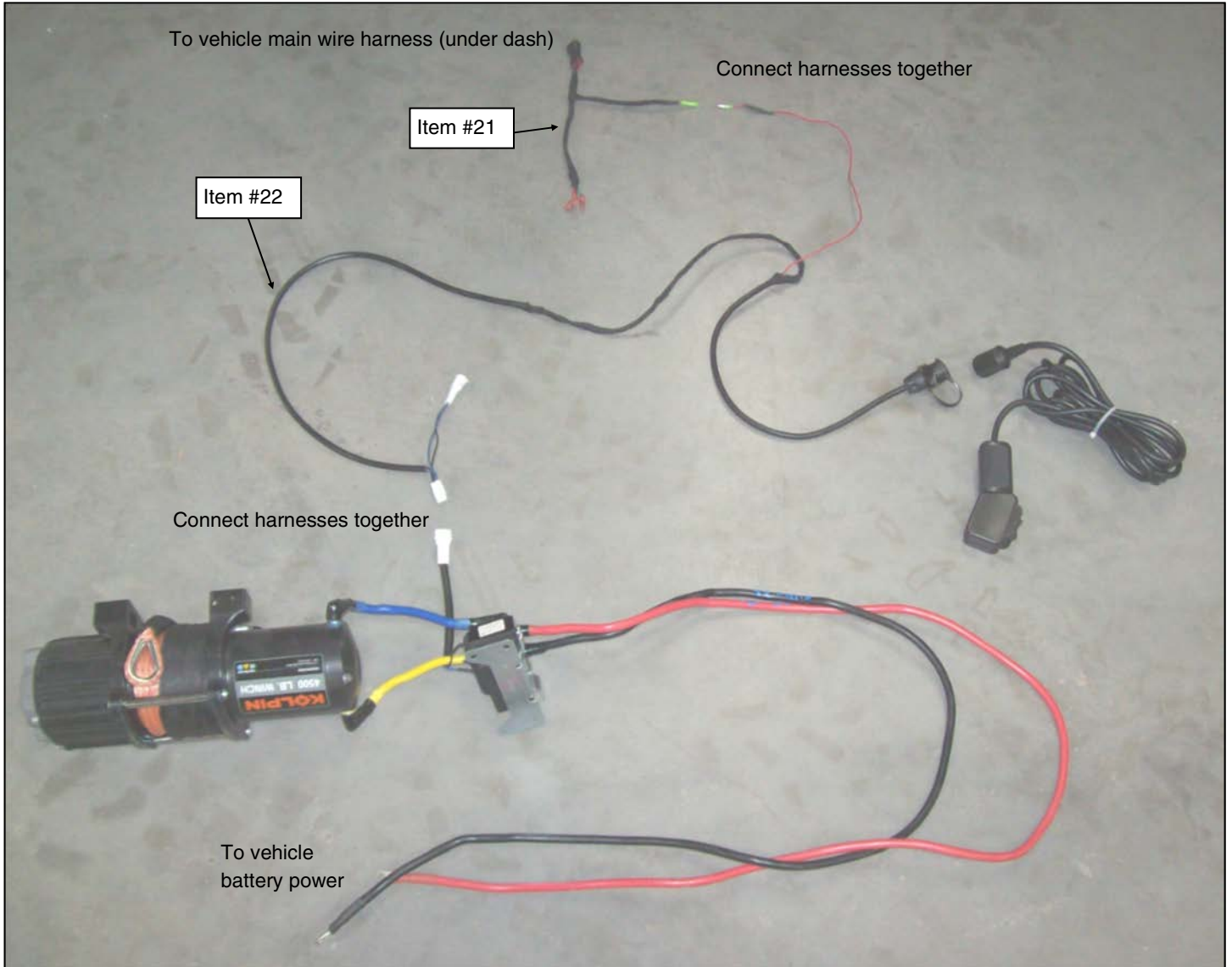

ELECTRICAL CONNECTION REFERENCE GUIDE (continued):

2013 & Newer Ranger XP 570 / XP 900 with standard 3-post terminal busbar (not Equipped with Pulse Bar):
Winch with Roller Fairlead, Dash Switch and Corded Remote Switch

