

USER'S MANUAL

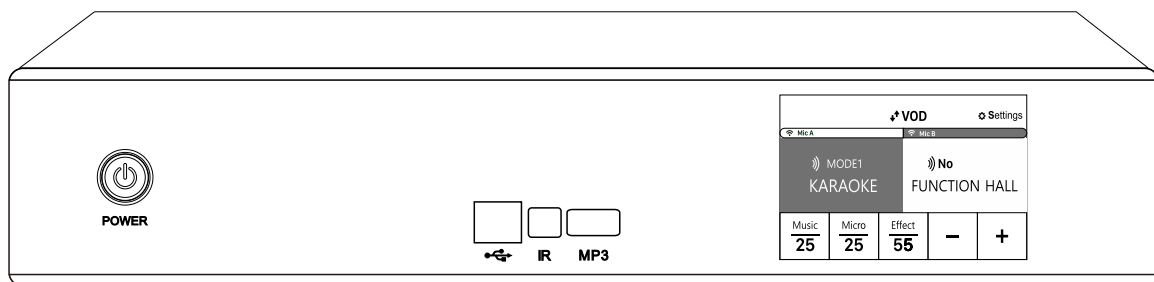

Preface

Thank you for purchasing our products. Before operating this machine, please read this instruction manual thoroughly so that you can understand how to use this equipment correctly. After you have read this manual, please keep it in a safe place for future reference.

Important Safety Instruction

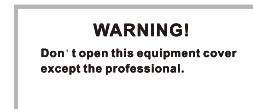
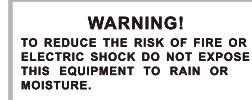

During thunderstorms or if you do not plan to use the device for a long time, unplug the device from the power source to prevent any damage. Do not place the device where it is vulnerable to dripping or spraying. For example, do not place containers containing liquids on the device to prevent the device from getting wet. If the equipment experiences water infiltration, disconnect the power immediately and take the equipment to the dealer or the manufacturer for maintenance. In order to ensure the normal operation of the equipment, do not block the heat dissipation holes and fan holes of the machine. Do not install the device near heat sources such as radiators, electric heaters, stoves or other devices (including amplifiers) that generate heat. If the device fails, contact your dealer or manufacturer.

Simple Fault and Overhaul

Note:

In order to avoid unnecessary losses to you during transportation, when the machine fails, it is not necessarily a problem with the machine. Therefore, please check the following methods before you submit for repair. After the fault is determined, you can package the machine and return it to our company. We will provide you with enthusiastic repair services.

Phenomenon	Cause	Solution
No sound output and the display is off	The power socket has no power supply	Check the power supply system
	The socket is not well plugged	Please connect the power socket well and maintain good contact.
	The AC voltage fuse is burnt.	Unplug the power socket and exchange with the fuse of the same specification.
No sound output but the display is on	The output acoustics has no good signal connection	Reconnect and maintain good contact
	The main sound is set to the minimum	Reset as the setting means in the Instruction Manual
	The machine is set as mute.	Cancel mute
	The signal source has no signal output	Check the signal source
Have only one channel for sound output	The speaker output signal line on one side is not well connected	Reconnect and ensure good contact
	One input signal is wrongly connected or not connected	Reconnect and ensure good contact
	Damaged signal line	Replace and reconnect, ensure good contact

Front Panel Instruction

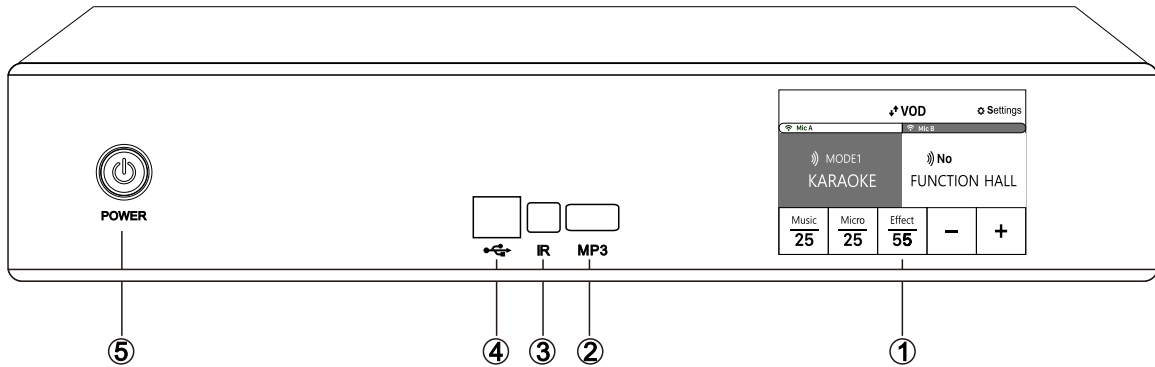

- 1 . Touch screen display
- 2 . MP 3 play interface
- 3 . Infrared remoted port
- 4 . USB interface connect to computer
- 5 . power switch

After press power switch , the screen will display "loading..." about 3 second , when we see the colorful screen , which means the soft start work is completed .

Function Description of the Touch Screen

Turn-on interface, connect to the power supply. After turning on the power switch, the equipment has the default display interface, which is shown in the below diagram;

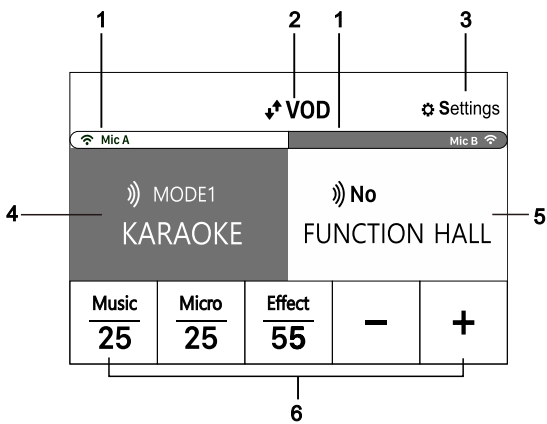

1. Wireless microphone signal indication:
When the wireless microphone is turned on, and frequency are matched ,the bar is highlighted.

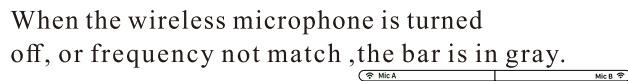
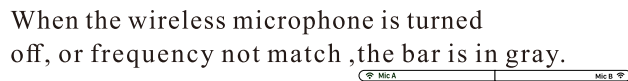

When the wireless microphone is turned off, or frequency not match ,the bar is in gray.

2. Display the present input signal source. Touching this area enters the input signal selection interface.

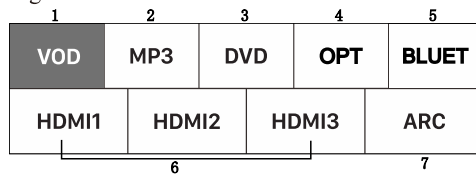

- 1) VOD: VOD signal input
- 2) MP 3 signal input
- 3) DVD: CD\DVD\VCD signal input
- 4) optical fiber signal input
- 5) Bluetooth signal input
- 6) HDMI1/2/3 signal input
- 7) ARC: TV audio signal return input

3. Touch setting enters the parameter setting interface

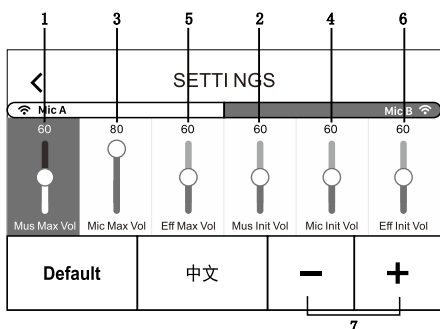

- 1) Music max volume: 0 - 80
- 2) Music start-up volume: 0 - 80
- 3) Microphone max volume: 0 - 80
- 4) Microphone start-up volume: 0 - 80
- 5) Effect max volume: 0 - 80
- 6) Effect start-up volume: 0 - 80
- 7) Volume setting: increase/decrease

4. KARAOKE mode selection, it will pop up when you touch this area: Mode1 / Mode2 / Mode3 / Mode4, the selected mode will be highlighted. After 5 seconds without any operation, it will return to the startup interface automatically.

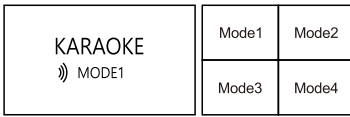

5. FUNCTION HALL mode selection. It will pop up Big Hall/Mid Hall/Small Hall/Conference. the selected mode will be highlighted. After 5 seconds without any operation, it will automatically return to the startup interface.



6. Music, microphone and effect volume display and volume adjustment selection. Touch and hold this area 3 seconds will be mute (red figures). Touch and hold 3 seconds to stop mute mode. Touch the corresponding area, select “+/-” to adjust the volume after showing the yellow frame.

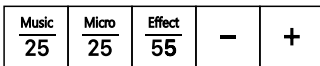

seconds Will be

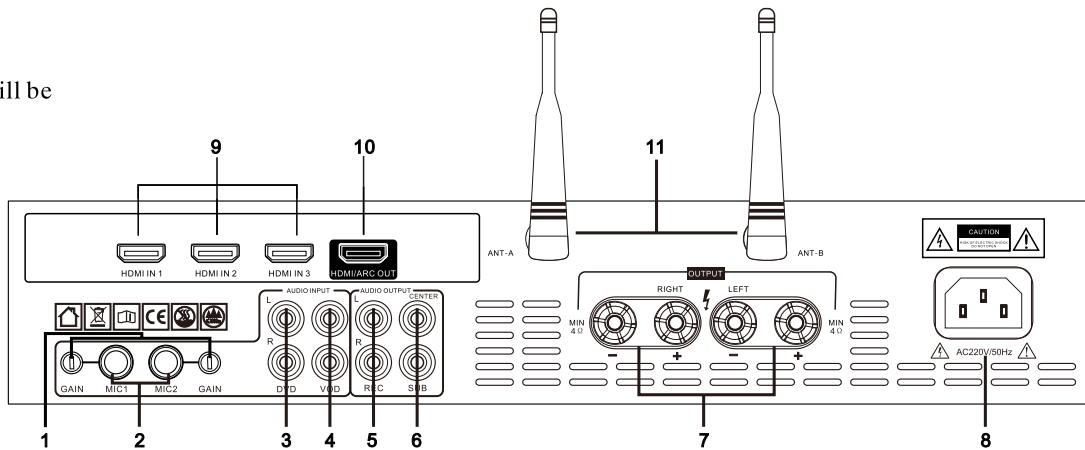

1. MIC1/MIC2 Gain
2. MIC1/MIC2 Input interface
3. DVD Audio input interface
4. VOD Audio input interface
5. REC Audio output interface: L/R main output interface
- 6.Center/Sub Output interface
7. Professional speaker output interface
Connect way: Red +; Black -
8. Power source input interface
9. HDMI Input interface
- 10.HDMI/RAC Output Interface
11. Wireless microphone antennas interface

Function of remote controller:

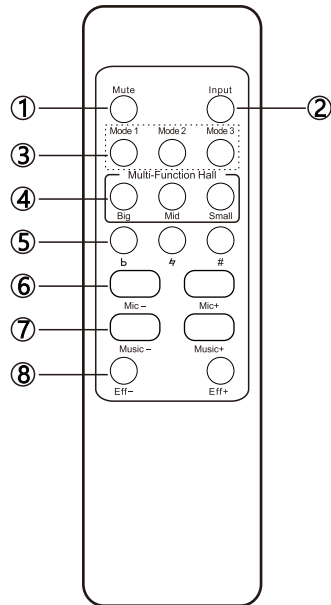

1. Mute button
2. Input signal selection button
3. Karaoke mode selection button
4. Multi-Function Hall mode selection
5. Tone change/decline/reset/rise
6. Microphone volume increase and decrease
7. Music volume increase and decrease
8. Effect volume increase and decrease

Technical parameters:

Output interface	Binding
Frequency response	20Hz-20kHz, ± 1.5 dB
Balance input impedance	10k Ω /un-Balanced
SNR	≥ 95 dB
T.H.D	≤ 0.2
Rated output power 8 ohm 1KHz degree of separation	> 70 dB
Damping factor f=1KHz 8 OHMS	> 240
Conversion speed	15V/ μ S
Protection	Soft Start, Short Circuit, Limiter, DC Fault, AC Line Fuse, Thermal Cut

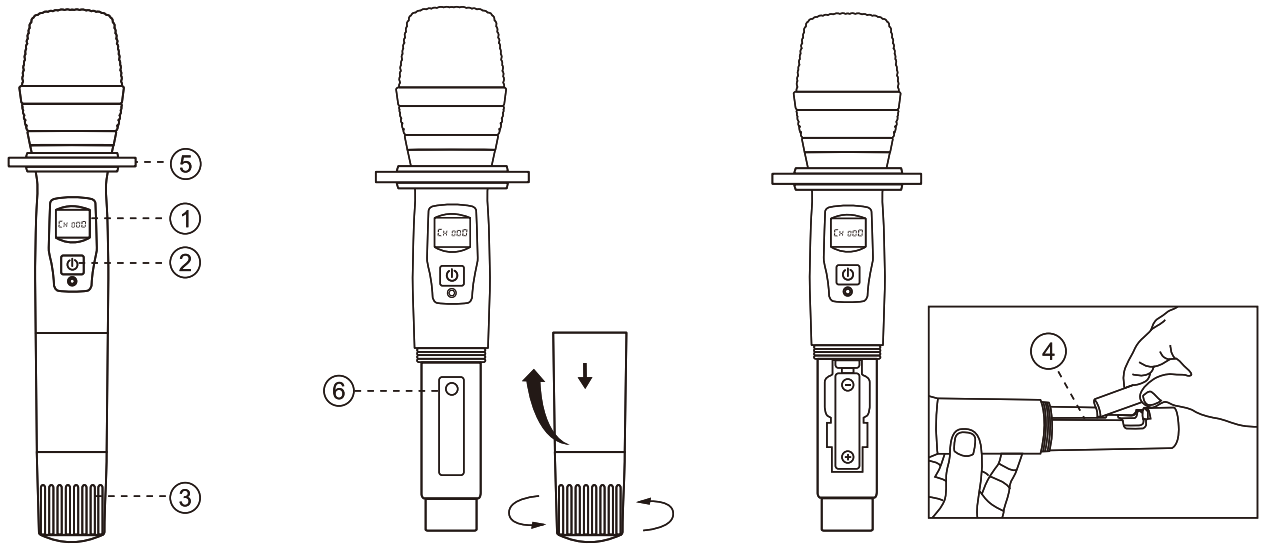

1. Structure of the Microphone

- ① LCD ② Power ③ Tail ④ Battery cabin ⑤ Stop ring ⑥ Digital frequency alignment button

2. Digital frequency alignment

Press the power switch about 3 seconds , power turn on , open the mic tube and press the digital frequency alignment button , will see screen flashing . After choose a frequency , press the power switch again to confirm the frequency , will see screen stop flashing , then put the microphone horizontal close to the device's IR port about 3 seconds , frequency sync successfully .(if fail , please just repeat above action) .Total 200 channels(A channle : 001CH~100CH ; Bchannel : 101CH~200CH)

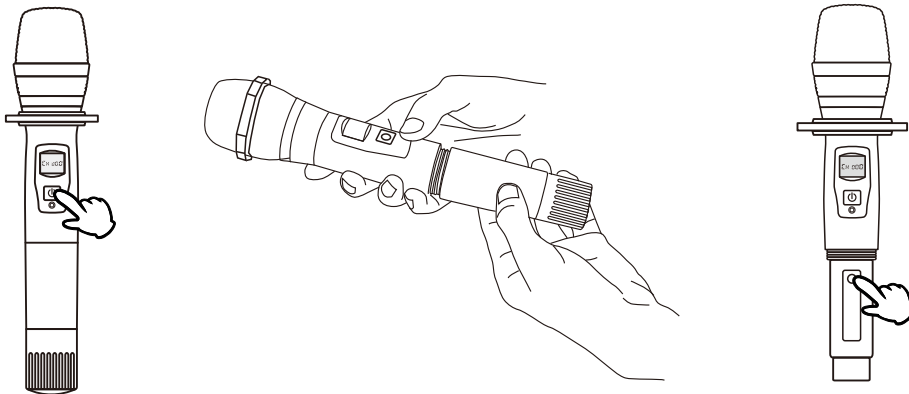

3. Turn on and turn off

Press the power switch about 3 seconds , the microphone LCD screen will light up and display working channel , working frequency and battery status .Please pay attention to the battery status , if electric quantity too low , LCD screen will display "LOW BAT" , to remind user to change a new pair of battery to make sure microphone works normally . Basically a new pair of battery woking life on this micorphone is 6-8 hours .Press again the power switch about 3 seconds , the LCD screen will display "OFF" , and then microphone will be turned off .Please remove the batteries when microphone don't need work for a long time to prevent battery leakage from corroding the circuit board and damage the microphone .

