

USER MANUAL

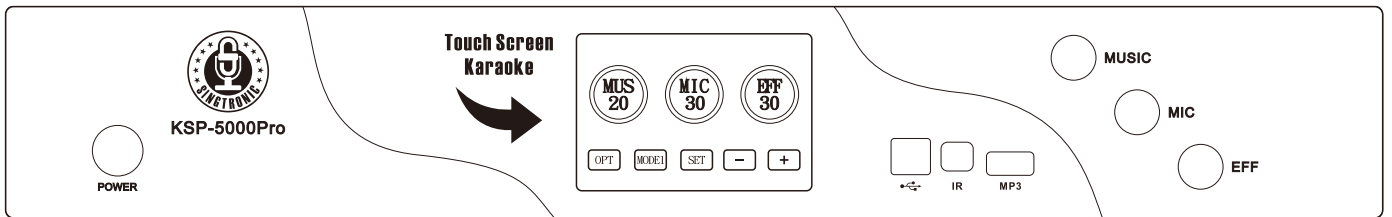

Preface

Thank you for purchasing our products. Before operating this machine, please read this instruction manual thoroughly so that you can understand how to use this equipment correctly. After you have read this manual, please keep it in a safe place for future reference.

Important Safety Instruction

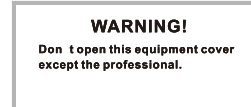
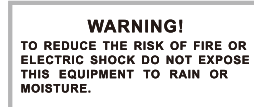

During thunderstorms or if you do not plan to use the device for a long time, unplug the device from the power source to prevent any damage. Do not place the device where it is vulnerable to dripping or spraying. For example, do not place containers containing liquids on the device to prevent the device from getting wet or getting water. If the equipment experiences water infiltration, disconnect the power immediately and take the equipment to the dealer or the manufacturer for maintenance. In order to ensure the normal operation of the equipment, do not block the heat dissipation holes and fan holes of the machine. Do not install the device near heat sources such as radiators, electric heaters, stoves or other devices (including amplifiers) that generate heat. If the device fails, contact your dealer or manufacturer.

Simple Fault and Overhaul

Note:

In order to avoid unnecessary losses to you during transportation, when the machine fails, it is not necessarily a problem with the machine. Therefore, please check the following methods before you submit for repair. After the fault is determined, you can package the machine and return it to our company. We will provide you with enthusiastic repair services.

Phenomenon	Cause	Solution
No sound output and the display is off	The power socket has no power supply	Check the power supply system
	The socket is not well plugged	Please connect the power socket well and maintain good contact.
	The AC voltage fuse is burnt.	Unplug the power socket and exchange with the fuse of the same specification.
No sound output but the display is on	The output acoustics has no good signal connection	Reconnect and maintain good contact
	The main sound is set to the minimum	Reset as the setting means in the Instruction Manual
	The machine is set as mute.	Cancel mute
	The signal source has no signal output	Check the signal source
Have only one channel for sound output	The speaker output signal line on one side is not well connected	Reconnect and ensure good contact
	One input signal is wrongly connected or not connected	Reconnect and ensure good contact
	Damaged signal line	Replace and reconnect, ensure good contact

Function Description of the Front Panel

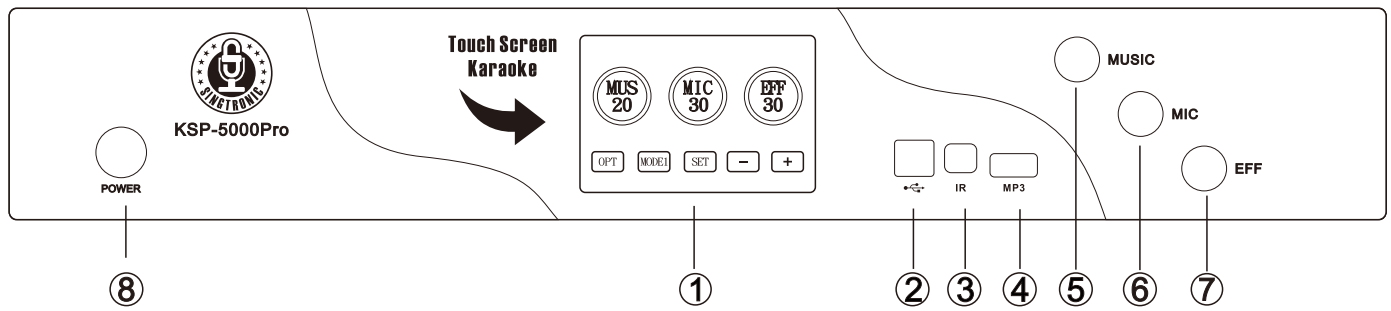

- 1 . Touch screen display
- 2 . USB interface connect to computer
- 3 . Infrared remoted port
- 4 . MP 3 play interface
- 5 . Music volume control
- 6 . Microphone volume control
- 7 . Effect volume control
- 8 . power switch

After press power switch , the screen will display "loading..." about 3 second , when we see the colorful screen , which means the soft start work is completed .

Function Description of the Touch Screen

Turn-on interface, connect to the power supply. After turning on the power switch, the equipment has the default display interface, which is shown in the below diagram;

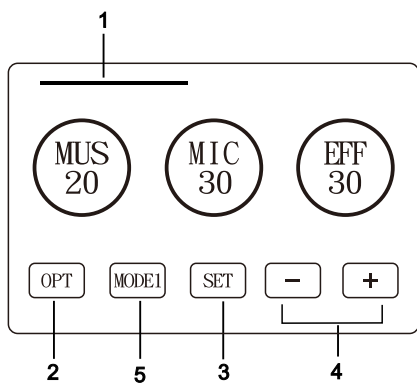

1. Wireless microphone signal indication:

When the wireless microphone is turned on, and frequency are matched ,the bar is highlighted.

When the wireless microphone is turned off, or frequency not match ,the bar is disappeared.

2. Display the present input signal source. Touching this area enters the input signal selection interface.

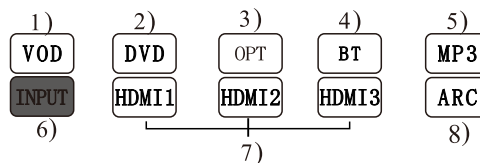

- 1) VOD:VOD signal input
- 2) DVD:CD\DVD\VCD signal input
- 3) OPT: optical signal input
- 4) BT: Bluetooth signal input
- 5) MP 3 signal input
- 6) INPUT: Indicates the current page content
- 7) HDMI1、 2、 3 signal input
- 8) ARC:TV audio signal return

3. Touch setting enters into the parameter setting interface

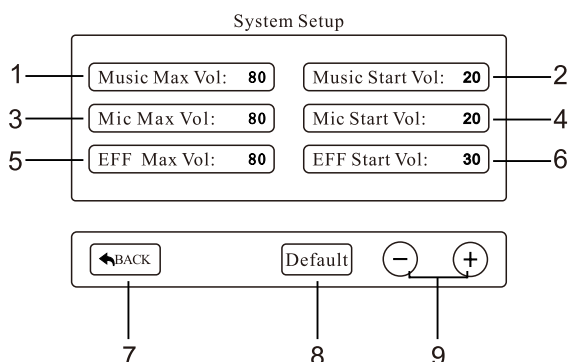

- 1) Music max volume: 0 - 80
- 2) Music start-up volume: 0 - 80
- 3) Microphone max volume: 0 - 80
- 4) Microphone start-up volume: 0 - 80
- 5) Effect max volume: 0 - 80
- 6) Effect start-up volume: 0 - 80
- 7) BACK:return to home page
- 8) Default: choose to recover the factory setting or not
- 9) Volume setting: increase/decrease

4. Music, microphone and effect volume display and volume adjustment selection. Touch the corresponding area, select “+/-” to adjust the volume after showing the yellow frame.

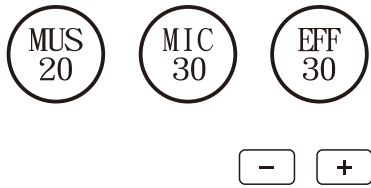

5. **MODE1** mode selection, it will pop up when you touch this area: MODE1/MODE2/MODE3/MODE4/MODE5/MODE6/MODE7/MODE8, the selected mode will be highlighted. After 5 seconds without any operation, it will automatically return to the startup interface.

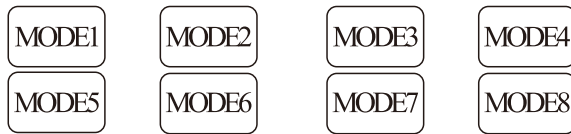

Introduction of rear panel

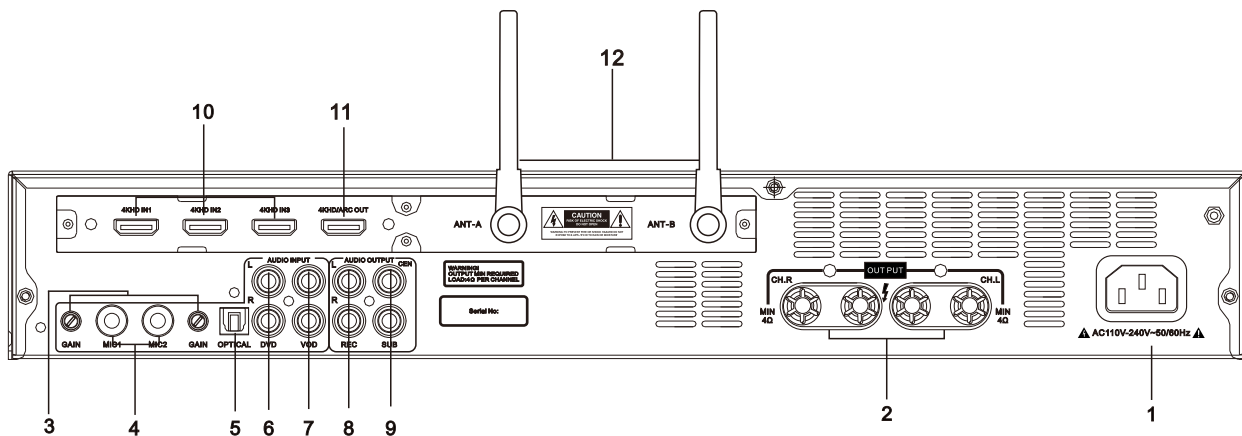

1. Power source input socket
2. The connection means of the professional wiring column is red+ black-.
3. MIC 1 / MIC 2 gain control
4. MIC 1 / MIC 2 input socket
5. Optical audio input socket
6. DVD audio input socket
7. VOD audio input socket
8. REC audio output socket: L/ R main output socket
9. CED/ultra-low sound output socket
10. 4KHD/ ARC OUT socket: For connecting an 4KHD-compatible TV and outputting video / TV audio signal return
11. 4KHD(1 - 3) socket: For connecting an 4KHD-compatible playback device and inputting video / audio signals
12. Wireless microphone receiving antenna

Function of remote controller:

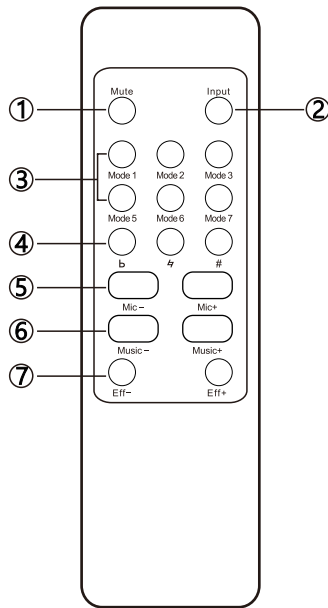

- 1. Mute button
- 2. Input signal selection button
- 3. Mode selection buttons
- 4. Tone change: decline/reset/rise
- 5. Microphone volume increase or decrease
- 6. Music volume increase or decrease
- 7. Effect volume increase or decrease

Technical parameters:

Output interface	Binding
Frequency response	20Hz-30kHz, ±1.5dB
Input sensitivity	0.5V
Balance input impedance	10kΩ/un-Balanced
SNR	≥95dB
Distortion	≤0.2
Rated output power 8 ohm 1KHz degree of separation	>70 dB
Damping factor f=1KHz 8 OHMS	>240
Conversion speed	15V/uS
Protection	Soft Start, Short Circuit, Limiter, DC Fault, AC Line Fuse, Thermal Cut
Cooling system	Fan

External Equipment Connecting Diagram

When connecting the speaker connector, please confirm the +,-polarity and the left (L) and right (R) channels, and do not connect the reverse cable. The speaker connector should be careful not to come off and come into contact with other terminals or the rear panel. In addition, please be careful not to contact the polarity of the speaker connector or the cable of the channel.

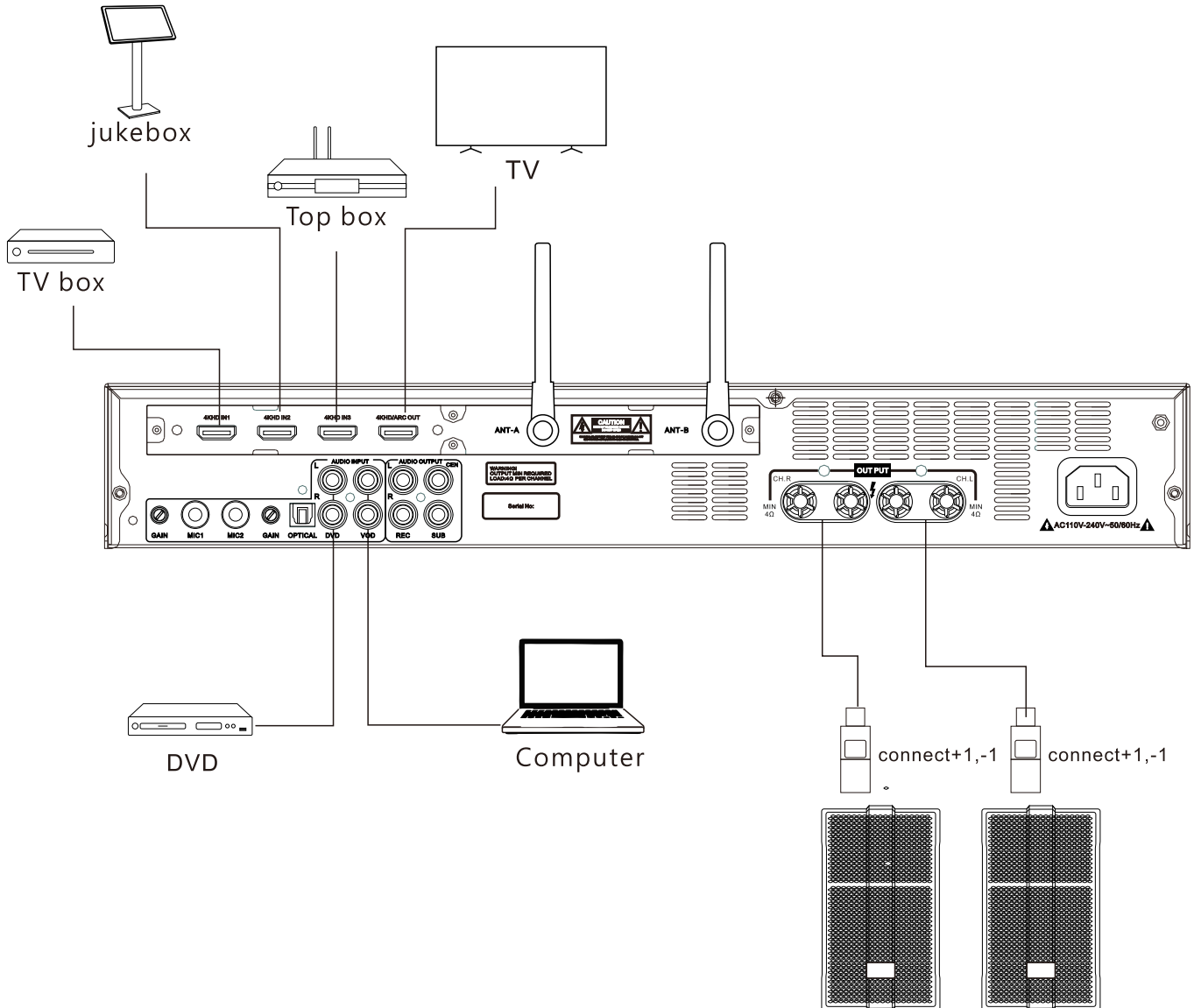

About speaker impedance

If the high-power output for a long time is lower than the speaker (such as 4Ω) of the rated impedance ($6 \sim 8\Omega$), the built-in protection circuit will automatically start. After the protection circuit is activated, please unplug the power cord, maintain good ventilation, and reconnect the power after reducing the temperature.

In connecting the signal cable

When connecting the signal cable, after unplugging the power cord of the device, please note that the left channel (L: white) and rear channel (R: red) of the connection terminal may have some differences with the equipment. Please refer to the instruction manual of the product before connecting to make sure to connect correctly. If the left and right signal cables are reversed, the stereo effect will be reduced.

Introduction of the Microphone Function

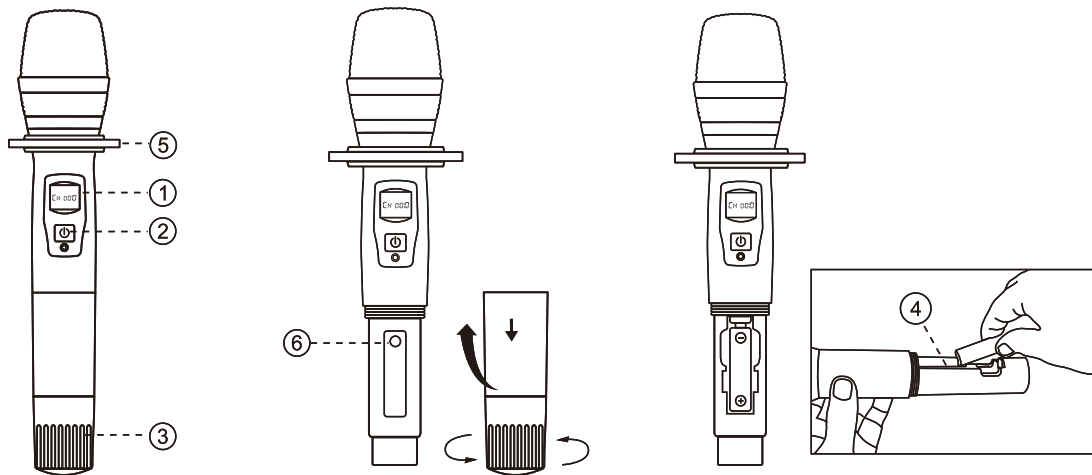

1. Structure of the Microphone

- ① LCD ② Power ③ Tail ④ Battery cabin ⑤ Stop ring ⑥ Digital frequency alignment button

2. Frequency synchronization

Microphone has total 200 channels .A channel : 001~100CH ;B channel:101~200CH .A/B channel frequency synchronization method as below :

Unscrew the tailpipe ,turn on the handheld mic power ,screen light up .press the digital frequency alignment button,screen flashed,Frquency will gradually increased ,confirm the frequency by power switch , align the microphone with the IR port on amplifier quickly, and better distance within 5cm,at this time, if A/B mic bar on amplifier screen lighted up , means frequency sync sucessfully ; if A/B mic bar not lighted up , means frequency sync fail ,Please repeat above operation

If 1 microphone sync to A channel , then the other one shouc choose 101~200ch to match to B channel.Conversely ,if the microphone sync to B channel , then the other one should choose 001~100CH.

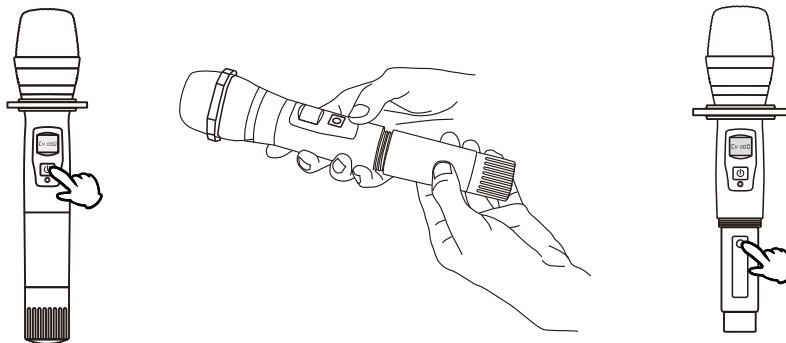

3. Turn on and turn off

Press the power switch down for about 2 seconds, the microphone display will light up and the LCD screen will display related working information, including the operating frequency (channel), battery power and other information. Every time you turn on the battery, you must pay attention to the battery power display status, and choose whether to replace the battery according to the actual time to be used. Under normal circumstances, a pair of ordinary AA batteries can be used normally for 8 hours. When the battery power is 1 division, the display will flash the low voltage prompt "LOW BAT", indicating that the battery power is a bout to run out, please replace the battery. In addition, the backlight of the display screen will automatically turn off in a few seconds after the microphone is turned on to enter the energy saving mode. If you need to view the display information during use, you can press the power switch once. Press and hold the power switch for about 3 seconds, the display will show "OFF", and then the microphone will be turned off. When the microphone is not ready for use for a long time, please remove the battery to prevent the battery leakage from corroding the circuit board and damaging the microphone.

