

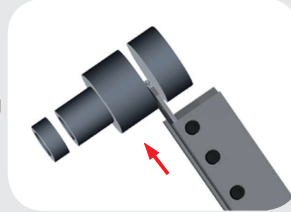

External Parting Blade

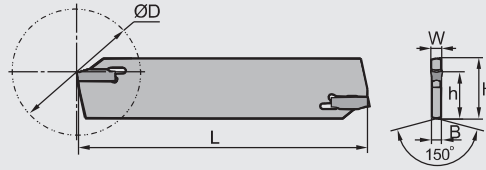

Type	Dimension(inch)						Inserts	Wrench
	L	H	h	B	W	ØDmax		
QEES26N	4.331	1.024	0.748	0.079	0.098	2.362	ZPES02502-MG	W50RL
QEFS26N	4.331	1.024	0.748	0.094	0.118	2.362	ZPFS0302-MG	
QEGS26N	4.331	1.024	0.748	0.126	0.157	2.756	ZPGS0402-MG	
QEHS26N	4.331	1.024	0.748	0.157	0.197	2.756	ZPHS0503-MG	
QEKs26N	4.331	1.024	0.748	0.197	0.236	2.756	ZPKS0604-MG	
QEES32N	5.906	1.260	0.969	0.079	0.098	3.937	ZPES02502-MG	
QEFS32N	5.906	1.260	0.969	0.094	0.118	3.937	ZPFS0302-MG	
QEGS32N	5.906	1.260	0.969	0.126	0.157	4.724	ZPGS0402-MG	
QEHS32N	5.906	1.260	0.969	0.157	0.197	4.724	ZPHS0503-MG	
QEKs32N	5.906	1.260	0.969	0.197	0.236	4.724	ZPKS0604-MG	

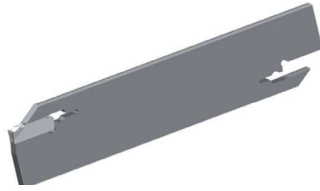

B

Face Grooving and Turning Tools

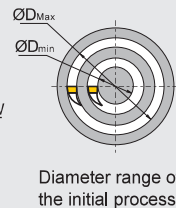
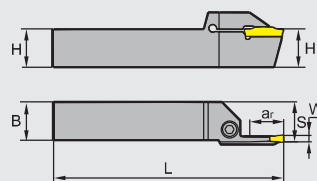

L hand



Type	Dimension(inch)						Inserts	Screw	Wrench
	H×B	L	S	W	ar	ØD (min-max)			
QFFD16-03DR/L10-48H	1.000×1.000	6	1.024	0.118	0.394	1.890-2.598	ZTFD0303-MG	GB70-85-M6×20	WH50L
QFFD16-03DR/L17-48H	1.000×1.000	6	1.024	0.118	0.669	1.890-2.598			
QFFD16-03DR/L10-60H	1.000×1.000	6	1.024	0.118	0.394	2.362-3.150			
QFFD16-03DR/L17-60H	1.000×1.000	6	1.024	0.118	0.669	2.362-3.150			
QFFD16-03DR/L10-74H	1.000×1.000	6	1.024	0.118	0.394	2.913-4.331			
QFFD16-03DR/L17-74H	1.000×1.000	6	1.024	0.118	0.669	2.913-4.331			

Face Grooving and Turning Tools

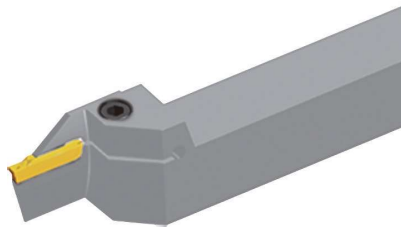

L hand

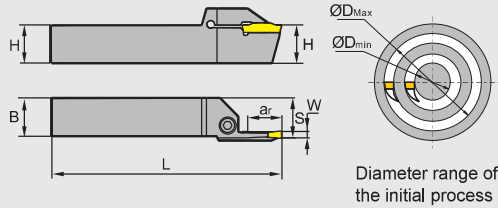

Diameter range of the initial process

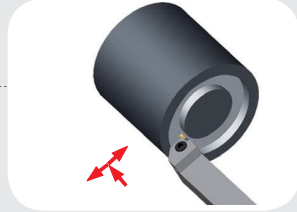

B

Type	Dimension(inch)						Inserts	Screw	Wrench
	H×B	L	S	W	ar	ØD (min-max)			
QFFD16-03DR/L10-100H	1.000×1.000	6	1.024	0.118	0.394	3.937-5.906	ZTFD0303-MG	GB70-85-M6×20	WH50L
QFFD16-03DR/L17-100H	1.000×1.000	6	1.024	0.118	0.669	3.937-5.906			
QFGD16-04DR/L13-52H	1.000×1.000	6	1.024	0.157	0.512	2.047-2.835	ZTGD0404-MG		
QFGD16-04DR/L22-52H	1.000×1.000	6	1.024	0.157	0.866	2.047-2.835			
QFGD16-04DR/L13-64H	1.000×1.000	6	1.024	0.157	0.512	2.520-3.937			
QFGD16-04DR/L22-64H	1.000×1.000	6	1.024	0.157	0.866	2.520-3.937			
QFGD16-04DR/L13-90H	1.000×1.000	6	1.024	0.157	0.512	3.543-5.512			
QFGD16-04DR/L22-90H	1.000×1.000	6	1.024	0.157	0.866	3.543-5.512			
QFGD16-04DR/L13-130H	1.000×1.000	6	1.024	0.157	0.512	5.118-9.055			
QFGD16-04DR/L22-130H	1.000×1.000	6	1.024	0.157	0.866	5.118-9.055			
QFHD16-05DR/L13-58H	1.000×1.000	6	1.024	0.197	0.512	2.238-3.780	ZTHD0504-MG		
QFHD16-05DR/L22-58H	1.000×1.000	6	1.024	0.197	0.866	2.238-3.780			
QFHD16-05DR/L13-86H	1.000×1.000	6	1.024	0.197	0.512	3.386-5.512			
QFHD16-05DR/L22-86H	1.000×1.000	6	1.024	0.197	0.866	3.386-5.512			
QFHD16-05DR/L13-130H	1.000×1.000	6	1.024	0.197	0.512	5.118-7.874			
QFHD16-05DR/L22-130H	1.000×1.000	6	1.024	0.197	0.866	5.118-7.874			
QFHD16-05DR/L13-185H	1.000×1.000	6	1.024	0.197	0.512	7.283-15.748			
QFHD16-05DR/L22-185H	1.000×1.000	6	1.024	0.197	0.866	7.283-15.748			
QFHS16-05DR/L30-185H	1.000×1.000	6	1.024	0.197	1.181	7.283-15.748	ZTHS0504-MG		
QFKD16-06DR/L13-60H	1.000×1.000	6	1.024	0.236	0.512	2.362-3.937	ZTKD0608-MG		
QFKD16-06DR/L22-60H	1.000×1.000	6	1.024	0.236	0.866	2.362-3.937			
QFKD16-06DR/L13-88H	1.000×1.000	6	1.024	0.236	0.512	3.465-7.087			
QFKD16-06DR/L22-88H	1.000×1.000	6	1.024	0.236	0.866	3.465-7.087			
QFKD16-06DR/L13-160H	1.000×1.000	6	1.024	0.236	0.512	6.299-15.748			
QFKD16-06DR/L22-160H	1.000×1.000	6	1.024	0.236	0.866	6.299-15.748			
QFKS16-06DR/L30-160H	1.000×1.000	6	1.024	0.236	1.181	6.299-15.748	ZTKS0608-MG		
QFLD16-08DR/L25-75H	1.000×1.000	6	1.063	0.315	0.984	2.953-5.906	ZTLD0808-MM		
QFLD16-08DR/L25-140H	1.000×1.000	6	1.063	0.315	0.984	5.512-15.748			
QFLD20-08ER/L28-140H	1.250×1.250	7	1.181	0.315	1.102	5.512-15.748			

Face Grooving and Turning Tools

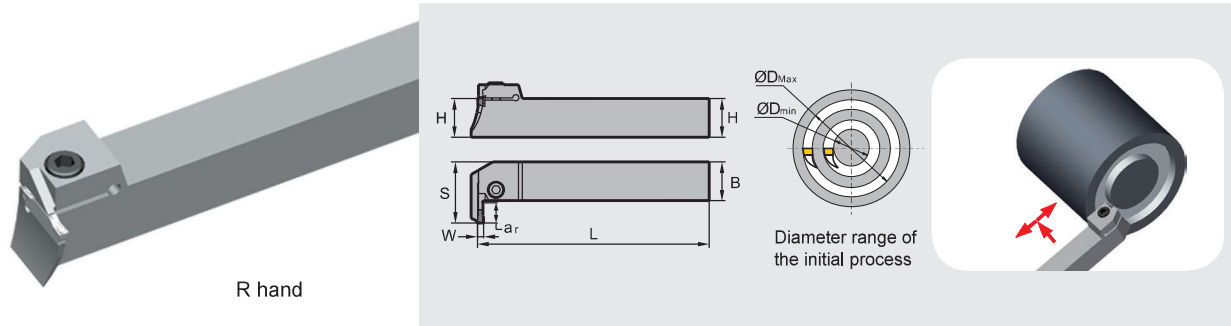

Type	Dimension(inch)						ØD (min-max)	Inserts	Screw	Wrench
	H×B	L	S	W	ar					
QFFD16-03DR/L10-48L	1.000×1.000	6	1.024	0.118	0.394	1.890-2.598	ZTFD0303-MG	GB70-85-M6×20	WH50L	
QFFD16-03DR/L17-48L	1.000×1.000	6	1.024	0.118	0.669	1.890-2.598				
QFFD16-03DR/L10-60L	1.000×1.000	6	1.024	0.118	0.394	2.362-3.150				
QFFD16-03DR/L17-60L	1.000×1.000	6	1.024	0.118	0.669	2.362-3.150				
QFFD16-03DR/L10-74L	1.000×1.000	6	1.024	0.118	0.394	2.913-4.331				
QFFD16-03DR/L17-74L	1.000×1.000	6	1.024	0.118	0.669	2.913-4.331				
QFFD16-03DR/L10-100L	1.000×1.000	6	1.024	0.118	0.394	3.937-5.906				
QFFD16-03DR/L17-100L	1.000×1.000	6	1.024	0.118	0.669	3.937-5.906				
QFGD16-04DR/L13-52L	1.000×1.000	6	1.024	0.157	0.512	2.047-2.835	ZTGD0404-MG			
QFGD16-04DR/L22-52L	1.000×1.000	6	1.024	0.157	0.866	2.047-2.835				
QFGD16-04DR/L13-64L	1.000×1.000	6	1.024	0.157	0.512	2.520-3.937				
QFGD16-04DR/L22-64L	1.000×1.000	6	1.024	0.157	0.866	2.520-3.937				
QFGD16-04DR/L13-90L	1.000×1.000	6	1.024	0.157	0.512	3.543-5.512				
QFGD16-04DR/L22-90L	1.000×1.000	6	1.024	0.157	0.866	3.543-5.512				
QFGD16-04DR/L13-130L	1.000×1.000	6	1.024	0.157	0.512	5.118-9.055				
QFGD16-04DR/L22-130L	1.000×1.000	6	1.024	0.157	0.866	5.118-9.055				
QFHD16-05DR/L13-58L	1.000×1.000	6	1.024	0.197	0.512	2.238-3.780	ZTHD0504-MG			
QFHD16-05DR/L22-58L	1.000×1.000	6	1.024	0.197	0.866	2.238-3.780				
QFHD16-05DR/L13-86L	1.000×1.000	6	1.024	0.197	0.512	3.386-5.512				
QFHD16-05DR/L22-86L	1.000×1.000	6	1.024	0.197	0.866	3.386-5.512				
QFHD16-05DR/L13-130L	1.000×1.000	6	1.024	0.197	0.512	5.118-7.874				
QFHD16-05DR/L22-130L	1.000×1.000	6	1.024	0.197	0.866	5.118-7.874				
QFHD16-05DR/L13-185L	1.000×1.000	6	1.024	0.197	0.512	7.283-15.748				
QFHD16-05DR/L22-185L	1.000×1.000	6	1.024	0.197	0.866	7.283-15.748				
QFHS16-05DR/L30-185L	1.000×1.000	6	1.024	0.197	1.181	7.283-15.748	ZTHS0504-MG			
QFKD16-06DR/L13-60L	1.000×1.000	6	1.024	0.236	0.512	2.362-3.937	ZTKD0608-MG			
QFKD16-06DR/L22-60L	1.000×1.000	6	1.024	0.236	0.866	2.362-3.937				
QFKD16-06DR/L13-88L	1.000×1.000	6	1.024	0.236	0.512	3.465-7.087				
QFKD16-06DR/L22-88L	1.000×1.000	6	1.024	0.236	0.866	3.465-7.087				
QFKD16-06DR/L13-160L	1.000×1.000	6	1.024	0.236	0.512	6.299-15.748				
QFKD16-06DR/L22-160L	1.000×1.000	6	1.024	0.236	0.866	6.299-15.748				
QFKS16-06DR/L30-160L	1.000×1.000	6	1.024	0.236	1.181	6.299-15.748	ZTKS0608-MG			

B