



Wall Mount

Models: 2400



Installation, Operation, and Maintenance Instructions

.....
Please read all instructions before attempting installation or operation of these units
.....

SAVE THESE INSTRUCTIONS FOR FUTURE USE

PUBLICATION No.
5 0 1 7 5 2 9 3 6

Revised
December 7, 2011



2400 Wall Mount



TABLE OF CONTENTS

<u>Section</u>	<u>Page No.</u>
Introduction	2
Notice to Installers	3
Cautions and Warnings	4
Model Information	5
Parts List	6
Kits List (Kits contained within the Parts List)	7
Tools Required	9
Wood Pad Installation	10
Unit Installation	12
Operation Guidelines	16
Maintenance	17
Maintenance Check Sheet	18



2400 Wall Mount



INTRODUCTION

Thank you for your purchase of our Model 2400 Wall Mounted Backstop. To ensure that our equipment will provide years of use to you, we are including this installation, operation, and maintenance guide. This guide will provide information on the proper assembly and installation methods, operating procedures, and preventative maintenance of your wall mounted backstop.

Please do not substitute for factory parts!

Please contact your customer service representative and allow them to determine if substitute parts are acceptable.

It is recommended that an individual who has been properly trained perform assembly and set up of the backstop. No one under the age of 18 should attempt assembly or set up of the unit, unless properly supervised.

To prevent normal wear and tear from shortening the life of the unit, preventative maintenance inspections and repairs should be performed at least once per year. If the units are subject to high or unusual usage, inspections should be scheduled to occur more frequently. If items are found to be nonconforming, replacements can be ordered from the factory or one of our authorized dealers. When contacting Gared Sports or Performance Sports Systems, please have information regarding the dealer/installer who sold the unit, the name of the project, and any applicable warranty information.



2400 Wall Mount



NOTICE TO INSTALLERS

The following instructions are meant as a guide only. This guide is intended to assist you with the installation and operation of the Model 2400 Wall Mounted Backstop. Jobsite conditions will be different for each project, and conditions may change during the project. Any suggestions or tips contained herein are for general information, and may not apply to your particular installation.

Please contact Gared/ PSS for additional information if you are unsure how to proceed with the installation at any time, or if jobsite or building conditions change before or during this installation, thus affecting the correct installation of this unit.

It is imperative to inspect all material being used in this installation BEFORE you begin. Confirm that materials and parts received correspond to those listed on the packing list and production drawings. If any materials or parts have been damaged during shipping or are missing as a result of shipping, you must file a freight claim with the delivering freight company. Missing or damaged material must also be noted on the Bill of Lading at the time of delivery.

If materials or parts are determined to be missing due to factory error or oversight, contact Gared/ PSS immediately at 800-325-2682/ 800-848-8034.

Follow all local safety codes and OSHA regulations. Gared/ PSS will not be held liable, in any way, for improper installation or faulty workmanship at the jobsite.

Before proceeding with assembly, **READ ALL INSTRUCTIONS AND ASSEMBLY PROCEDURES**. Make sure all parts have been received and are not damaged.

This backstop has been manufactured in accordance with the specifications provided by the Owner/Architect.



CAUTIONS AND WARNINGS

Read and understand the following warnings to prevent possible personal injury and potential damage to the equipment during assembly, setup, and operation.

⚠ DANGER

DO NOT CLIMB ON GOAL, BANKBOARD OR BACKSTOP.

THIS UNIT IS DESIGNED FOR A SPECIFIC OPERATING WEIGHT AND THE ADDED WEIGHT COULD CAUSE DAMAGE AND/OR SERIOUS INJURY TO PERSONNEL.

2036-31-00

⚠ CAUTION

DO NOT STAND OR SIT ON UNIT DURING OPERATION

126453735

⚠ CAUTION

ONLY TRAINED AND AUTHORIZED PERSONNEL SHOULD OPERATE THIS EQUIPMENT. OPERATION BY UNTRAINED OR UNAUTHORIZED PERSONNEL MAY RESULT IN DAMAGE TO THE BACKSTOP OR BACKSTOP STRUCTURE AND/OR INJURY TO ANYONE NEAR THE BACKSTOP.

ALWAYS MAKE SURE AREA AROUND AND BELOW THE BACKSTOP IS CLEAR OF PERSONNEL AND OBSTACLES BEFORE OPERATING THE DEVICE.

NEVER STAND DIRECTLY UNDER THE BACKSTOP DURING OPERATION.

OPERATOR MUST KEEP BACKSTOP IN VIEW AT ALL TIMES DURING OPERATION.

KEY SWITCH OR CONTROL PAD MUST BE MOUNTED IN CLEAR VIEW OF THE BACKSTOP.

NEVER LEAVE KEY IN KEY SWITCH UNATTENDED.

NEVER HANG FROM SIDES OR BOTTOM OF BACKSTOP DURING OPERATION OR WHEN BACKSTOP IS IN THE LOWERED POSITION.

CAUTION SHOULD BE EXERCISED AT ALL TIMES WHEN OPERATING THE BACKSTOP.

ALWAYS FOLLOW PROPER SAFETY RULES.

⚠ WARNING

Failure to follow proper installation procedures can result in damage to goal and possible injury to personnel.
Read and understand all installation instructions before proceeding.

MODEL INFORMATION

MODEL NUMBER DEFINITION

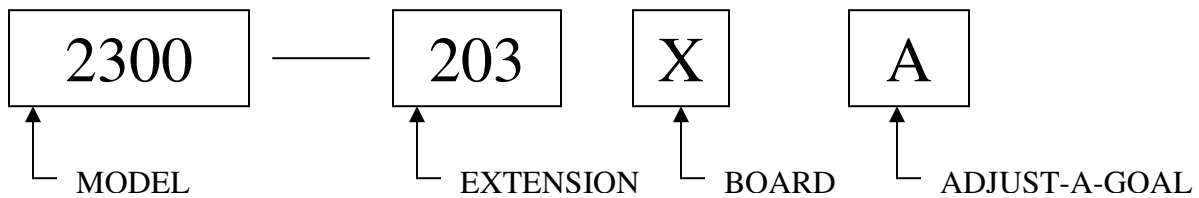

MODEL

- 2300 – 4 point stationary
- 2350 – 3 point stationary
- 2400 – 4 point fold up
- 2500 – 4 point side fold

EXTENSION

- 203 – 2' to 3' (see installation drawings for exceptions)
- 304 – 3' to 4' (see installation drawings for exceptions)
- 406 – 4' to 6' (see installation drawings for exceptions)
- 609 – 6' to 9' (see installation drawings for exceptions)
- 912 – 9' to 12' (see installation drawings for exceptions)

BOARD

- 0 – FAN SHAPED MOUNTING (NARROW FRAME – 35")
- 4 – RECTANGULAR BOARD MOUNTING (WIDE FRAME – 63")

ADJUST-A-GOAL

- A – With Adjust-A-Goal
- Blank – Without Adjust-A-Goal



2400 Wall Mount
PARTS LIST

2400 FOLD UP WALL MOUNT			EXTENSION		
PART NUMBER:	QTY:	DESCRIPTION:	4-6'	6-9'	9-12'
1040-30-00	10 ft	4/O STRAIGHT COIL CHAIN- ZINC	X		
1040-30-00	17 ft	4/O STRAIGHT COIL CHAIN- ZINC		X	
1040-30-00	24 ft	4/O STRAIGHT COIL CHAIN- ZINC			X
154151696	1 ea	HARDWARE KIT, WALL MOUNT UNITS	X	X	X
154151698	1 ea	CHAIN SUPPORT KIT	X	X	X
154151699	1 ea	SINGLE BRACE KIT	X	X	
154151700	1 ea	DOUBLE BRACE KIT			X
154151701	1 ea	FOLD - UP ADDER KIT	X	X	X
501752936	1 ea	MANUAL, 2400 FOLD UP WALL MOUNT	X	X	X
504151652	4 ea	PIPE, FU. INNER, 4-6'	X		
504151655	4 ea	PIPE, FU. OUTER, 4-6'	X		
504151653	4 ea	PIPE, FU. INNER, 6-9'		X	
504151656	4 ea	PIPE, FU. OUTER, 6-9'		X	
504151654	4 ea	PIPE, FU. INNER, 9-12'			X
504151657	4 ea	PIPE, FU. OUTER, 9-12'			X
504151670	2 ea	STRAP BRACING, 48" (NARROW FRAME)	X		
504151672	2 ea	STRAP BRACING, 69" (WIDE FRAME)	X		
504151671	2 ea	STRAP BRACING, 60" (NARROW FRAME)		X	
504151673	2 ea	STRAP BRACING, 78" (WIDE FRAME)		X	
504151670	4 ea	STRAP BRACING, 48" (NARROW FRAME)			X
504151672	4 ea	STRAP BRACING, 69" (WIDE FRAME)			X
504151790	1 ea	CROSS TUBE, FOLD UP FAN (NARROW FRAME)	X	X	X
504151791	1 ea	CROSS TUBE, FOLD UP RECT (WIDE FRAME)	X	X	X

2400 FOLD UP WALL MOUNT - WOOD PADS			FRAME SIZE
PART NUMBER:	QTY:	DESCRIPTION:	
504151591	3 ea	WOOD PAD, 3.5" HC, 48"	NARROW FRAME UNITS
504151590	3 ea	WOOD PAD, 3.5" HC, 72"	WIDE FRAME UNITS

2400 FOLD UP WALL MOUNT - W/ AAG			FRAME SIZE
PART NUMBER:	QTY:	DESCRIPTION:	
153954405	1 ea	KIT, FAN BOARD TO AAG	NARROW FRAME UNITS
153954404	1 ea	KIT, RECT BOARD TO AAG	WIDE FRAME UNITS
154155287	1 ea	NARROW AAG TO WM FRAME KIT	NARROW FRAME UNITS
154155281	1 ea	KIT, AAG TO WM MTG, 4PT RECT	WIDE FRAME UNITS

NOTE: SEE SHEETS 7, 8, AND 9 FOR KIT PARTS.



2400 Wall Mount
[KITS LIST](#)

HARDWARE KIT, WALL MOUNT UNITS		PART NO. 154151696
QTY.	PART NO.	DESCRIPTION
1	1000-26-00	BANK BOLT HARDWARE KIT
1	1001-26-00	GLASS BOARD GOAL BOLT KIT
2	501-6-16-56	BOLT, CARRIAGE 3/8"x 3 1/2"
4	502-6-16-56Z	BOLT, HEX HEAD 3/8"-16 x 3 1/2"
8	501-6-16-32	BOLT, CARRIAGE 3/8"-16 x 2"
4	502-6-16-40	BOLT, HEX HEAD 3/8"-16 x 2 1/2"
8	502-8-13-56	BOLT, HEX HEAD 1/2"-13 x 3 1/2"
16	504151706	BUSHING, FOLDING UNITS
4	512-6-16-6	SET SCREW, ALLEN FLT PT 3/8"x 3/8"
4	545-6-16Z	NUT, NYLON LOCK NUT 3/8"
8	545-8-13	NUT, NYLON LOCK 1/2"-13 COARSE
8	548-6-16	NUT, WHIZLOCK 3/8"

CHAIN SUPPORT KIT		PART NO. 154151698
QTY.	PART NO.	DESCRIPTION
6	1113-30-00	5/16" QUICK LINK
4	501-6-16-32	BOLT, CARRIAGE 3/8"-16 x 2"
2	504151595	BRACKET, UPPER CHAIN/ PULLEY MOUNT
4	548-6-16	NUT, WHIZLOCK 3/8"
2	7011-11-00	3/8" TURNBUCKLE W/ BOTH EYES

KIT, FOLD UP ADDER		PART NO. 154151701
QTY.	PART NO.	DESCRIPTION
1 ea	1005-07-00	#5 SWIVEL EYE BLOCK (3 1/2" PULLEY)
1 ea	1113-30-00	5/16" QUICK LINK
1 ea	1114-30-00	1/4" QUICK LINK
.5 ea	151651766	KIT, #92 STRAP CLAMP
1 ea	151651776	KIT, WALL MOUNTED PULLEY
1 ea	151652223	KIT, #105 TEE CLAMP
1 ea	154151703	MANUAL WINCH ADDER KIT
75 ft	3025-30-00	1/4" GALV. AIRCRAFT CABLE 7x19
2 ea	3225-30-00	1/4" CABLE CLAMP (FORGED CLIP)
2 ea	501-6-16-32	BOLT, CARRIAGE 3/8"-16 x 2"
1 ea	504151595	BRACKET, UPPER CHAIN/PULLEY MOUNT
4 ea	504151598	HINGE, UPFOLD SHORT
4 ea	504151600	HINGE, WOODPAD SHORT
2 ea	504151755	PLATE, BOARD BRACKET
2 ea	548-6-16	NUT, WHIZLOCK 3/8"



2400 Wall Mount



SINGLE BRACE KIT		PART NO. 154151699
QTY.	PART NO.	DESCRIPTION
2	1093-02-08	#93 STRAP CLAMP ASSEMBLY
1	151651766	KIT, #92 STRAP CLAMP
4	501651854	SPACER BUSHING, 2 1/8" TO 2 3/8"
1	502-6-16-16	BOLT, HEX HEAD 3/8"-16 x 1"
1	548-6-16	NUT, WHIZLOCK 3/8"

DOUBLE BRACE KIT		PART NO. 154151700
QTY.	PART NO.	DESCRIPTION
6	1093-02-08	#93 STRAP CLAMP ASSEMBLY
1	151651766	KIT, #92 STRAP CLAMP
12	501651854	SPACER BUSHING, 2 1/8" TO 2 3/8"
2	502-6-16-16	BOLT, HEX HEAD 3/8"-16 x 1"
2	548-6-16	NUT, WHIZLOCK 3/8"

KIT, RECTANGLE BOARD TO AAG		PART NO. 153954404
QTY.	PART NO.	DESCRIPTION
1	1000-26-00	BANK BOLT HARDWARE KIT
2	501-6-16-56	BOLT, CARRIAGE 3/8" x 3 1/2"
4	502-6-16-16	BOLT, HEX HEAD 3/8"-16 x 1"
2	502-6-16-56Z	BOLT, HEX HEAD 3/8"-16 x 3 1/2"
4	502-8-13-24	BOLT, HEX HEAD 1/2"-13 x 1 1/2"
2	503852349	BRACKET, ADJUSTABLE BOARD MOUNT
1	503853428	WELDMENT, DIRECT MOUNT EXTENSION
1	504151666	SUPPORT ANGLE, WM 63" CENTER
8	548-6-16	NUT, WHIZLOCK 3/8"
4	548-8-13	NUT, HEX, SERRATED FLANGE 1/2"-13

KIT, FAN BOARD TO AAG		PART NO. 153954405
QTY.	PART NO.	DESCRIPTION
1	1000-26-00	BANK BOLT HARDWARE KIT
4	502-6-16-16	BOLT, HEX HEAD 3/8"-16 x 1"
2	501-6-16-56	BOLT, CARRIAGE 3/8"x 3 1/2"
2	502-6-16-56Z	BOLT, HEX HEAD 3/8"-16 x 3 1/2"
4	502-8-13-24	BOLT, HEX HEAD 1/2"-13 x 1 1/2"
2	503852349	BRACKET, ADJUSTABLE BOARD MOUNT
1	503853428	WELDMENT, DIRECT MOUNT EXTENSION
1	504151667	SUPPORT ANGLE, WM 35" CENTER
8	548-6-16	NUT, WHIZLOCK 3/8"
4	548-8-13	NUT, HEX, SERRATED FLANGE 1/2"-13



2400 Wall Mount



KIT, AAG TO WM MTG, 4PT RECT		PART NO. 154155281
QTY.	PART NO.	DESCRIPTION
8	502-6-16-24	BOLT, HEX HEAD 3/8"-16 x 1 1/2"
4	502-8-13-32	BOLT, HEX HEAD 1/2"-13 x 2"
4	502-8-13-44	BOLT, HEX HEAD 1/2"-13 x 2 3/4"
1	504155373	FRAME, WIDE AAG TO WM ADAPTER BRACKET
8	548-6-16	NUT, WHIZLOCK 3/8"
4	548-8-13	NUT, HEX, SERRATED FLANGE 1/2"-13

KIT, NARROW AAG TO WALLMOUNT FRAME		PART NO. 154155287
QTY.	PART NO.	DESCRIPTION
8	502-6-16-24	BOLT, HEX HEAD 3/8"-16 x 1 1/2"
4	502-8-13-32	BOLT, HEX HEAD 1/2"-13 x 2"
4	502-8-13-44	BOLT, HEX HEAD 1/2"-13 x 2 3/4"
1	504155374	FRAME AAG, WM ADAPTER NARROW BRACKET
8	548-6-16	NUT, WHIZLOCK 3/8"
4	548-8-13	NUT, HEX, SERRATED FLANGE 1/2"-13

TOOLS REQUIRED

Electric Drill
 Drill bits – 9/16", 5/8"
 Hammer
 Wrenches – 1/2", 9/16", 11/16, and 3/4"
 Ratchet Wrenches with 1/2", 9/16", 11/16, and 3/4" sockets
 File
 4' Level
 25' Tape measure
 Duct Tape
 Block of wood (for tapping)
 Broom
 Shop-Vac
 Utility Knife
 Extra rope or chain

WOOD PAD INSTALLATION

Instructions for 2400 Up Fold Wall Mounts

- 1) Wood pads are provided for use in anchoring the units to the walls.
- 2) Verify all dimensions and locations with the General Contractor using the latest architectural prints before beginning. Also, verify floor thickness if not working over a finished floor. **NOTE: All production drawing dimensions override any dimensions contained within this manual.**
- 3) Mark the centerline of the unit on the wall utilizing the best method available.
- 4) Mark the centerline of the wood pad. Wood pads for rectangular boards are 72" wide, with predrilled bracket locations spaced 63" center to center. Wood pads for fan shaped boards are 48" wide, with predrilled bracket locations spaced 35" center to center. Anchors should be spaced to allow installation of chain and structure brackets without interference. The recommended layout is to have one anchor on each end of the wood pad (center approximately 1 13/16" from the outer most edge of the wood pad) and two evenly spaced in the center of the wood pad (see Figure 1).
- 5) Next mark anchor locations on the wood pad and drill through.
- 6) Use the holes drilled in the wood pad as a template to mark the anchor holes on the wall. Mark and drill the anchor holes in the wall. PSS recommends pads be bolted through the wall with through bolts and anchor plates. When it is not possible to bolt through the wall contact the structural engineer of the building for advice.

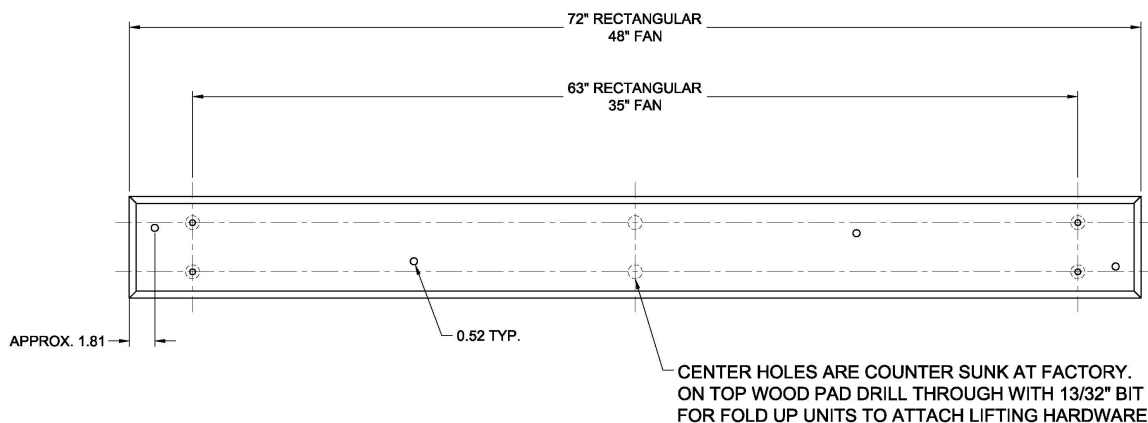
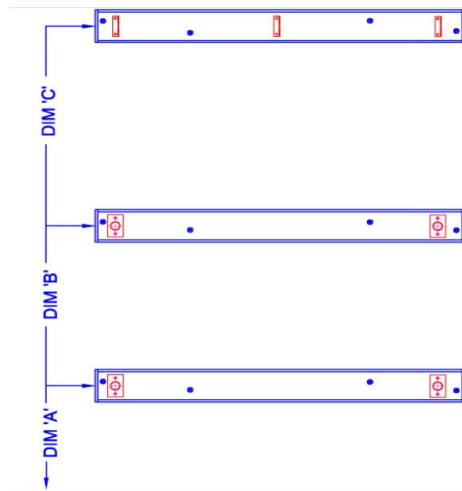

Figure 1 Generic wood pad drawing with recommended anchor locations.

NOTE: Anchor holes must not be drilled in line with each other or existing bracket holes.

- 7) Attach the brackets to the wood pad. Brackets for the chains should be spaced the same as the pipe supports. **NOTE: Attach the quick links and chains to the brackets prior to anchoring the wood pads to the wall.**
- 8) After all brackets are in place, anchor the wood pads in place on the wall, making sure to place the wood pads for chains and supports in the correct locations (per Figure 2).



NOTE: Wood pad dimensions for reference only. See production drawing for final A, B, and C dimensions. If production drawing cannot be located please contact the factory.

UNITS INSTALLED WITH OR WITHOUT AAG		
	DIM "A"	DIM "B"
Rectangular or Wide Mounting		
LXP 4200	9'-8 7/8" (2.97M)	36" (0.91M)
AFRG 42	9'-8 7/8" (2.97M)	36" (0.91M)
AFRG48	9'-2 11/16" (2.81M)	42" (1.07M)
RG	9'-2 11/16" (2.81M)	42" (1.07M)
1401B	9'-2 11/16" (2.81M)	42" (1.07M)
1272PS	9'-7" (2.91M)	36" (0.91M)
1442B	9'-7 11/16" (2.94M)	36" (0.91M)
BB72A38	9'-6 5/8" (2.91M)	36" (0.91M)
Fan or Narrow Mounting		
1342B	10'-1 7/8" (3.10M)	20" (0.51M)
1301B	10'-1 5/8" (3.09M)	20" (0.51M)
FSGII	10'-1 5/8" (3.09M)	20" (0.51M)
1750B	9'-9 7/16" (2.98M)	20" (0.51M)
1270B	10'-0 7/16" (3.05M)	20" (0.51M)
1272B	10'-0 7/16" (3.05M)	20" (0.51M)
1260B	10'-0 7/16" (3.05M)	20" (0.51M)
3050RG	10'-1 7/16" (3.09M)	20" (0.51M)
1245T	9'-9 13/16" (2.99M)	20" (0.51M)

ALL UNITS	
FOB EXTENSION	DIM "C"
0'-2' (0.0M-0.61M)	NONE
2'-4' (0.61M-1.22M)	24" (0.61M)
4'-6' (1.22M-1.83M)	35" (0.89M)
6'-9' (1.83M-2.74M)	56" (1.42M)
9'-12' (2.74M-3.66M)	79" (2.00M)
OVER 12'	*SEE JOB

Figure 2

UNIT INSTALLATION

- 1) Prepare the extension tubes by inserting bushings (as shown in Figure 3).

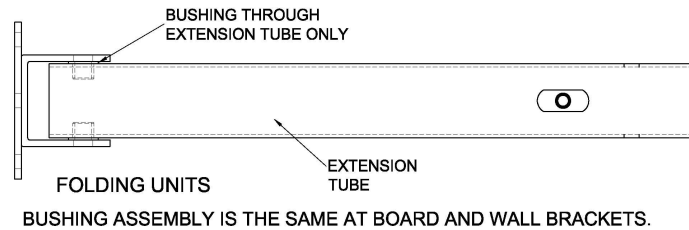
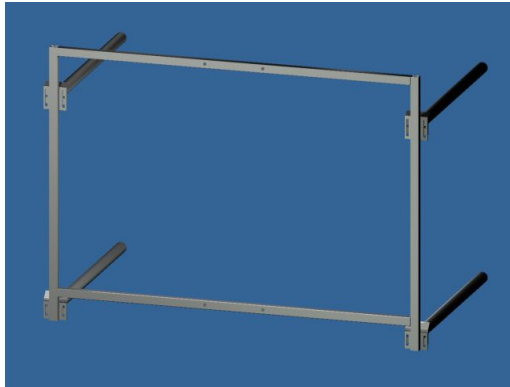

Figure 3. Bushing installation (looking down on extension).

- 2) To attach the outer extension tubes to the wall brackets, use a hex bolt and nylon lock nut as indicated on the production drawing. **Ensure that the tube will rotate through its full range of motion after tightening the nut. Do not over tighten the nut.**
- 3) The next step is to place the inner extension tubes into the outer extension tubes. **WARNING: The extension tubes must be temporarily roped or chained off in order to hold them in place.**

Steps (4) and (5) apply to installations with an Adjust-a-Goal. Refer to instructions received with AAG, for mounting board to AAG only. If you did not receive instructions please contact factory. If your installation does not have an Adjust-a-Goal, please skip to step (6).

- 4) The Adjust-a-Goal should be assembled prior to mounting to the extension arms and prior to mounting the board.
- 5) While assembling the AAG on the ground, the AAG mounting frame can be installed on the ends of the extension tubes. Utilize eight of the 3/8"-16 x 1 1/4" hex head bolts with washers and whiz lock nuts to attach the support plates of the frame to the end brackets of the extension tubes (refer to figure 4).



Wide



Narrow

Figure 4. Attach AAG mounting frame to extension tubes.

- 6) Connect the chains from the upper wood pad to the board mounting plate, utilizing the quick links provided.
- 7) At this point, it is equally acceptable to attach the board or hoist the adjust-a-goal into place at the end of the extension arms. **The wall mount must be supported as this is done.** If you are attaching the board, utilize the 3/8"-16 x 1" carriage bolts at the top support angle and the 3/8"-16 x 3.5" carriage bolts at the DME. To attach the adjust-a-goal, use (4) 1/2"-13 x 2" machine bolts and 1/2"-13 whiz-lock nuts.
- 8) After the board has been secured to the extension tubes, the board can be set to the proper distance from the wall, as specified by the latest architectural drawings.
- 9) To temporarily retain the extension tubes at the proper length, tighten the setscrews provided in the welded on T-nut (see Figure 5). At this time, the board should also be squared and leveled.

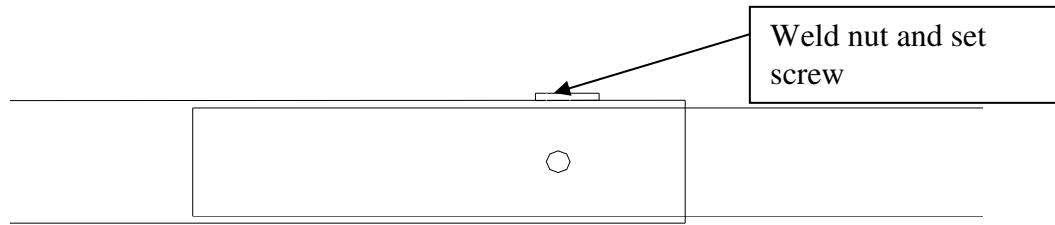

Figure 5. Close up of mating between inner and outer tubes, showing weld nut.

- 10) To permanently set the length of the extension arms, drill 3/8" holes through the inner tube at the predrilled location on the outer extension arms. Secure the inner tube to the outer tube with the provided hex head bolts and Whiz-Lock nuts (3/8"-16x 2 1/2").
- 11) Re-tighten the chains from the upper wood pad to the support angle, utilizing the quick links provided.
- 12) A 1.9" O.D. cross brace tube is provided, this is installed on the upper set of extension tubes about 3" or so from the bank end of the inner tube with (2) #105 T-clamps.
- 13) When installing the cross brace on the upper tubes, add a #92 clamp with quick link at the centerline of the unit. The winch cable will be attached at this point.
- 14) Run the winch cable through the pulley on the upper wood pad and down to the #92 clamp. Loop the cable through the quick link and secure it with cable clamps.
- 15) To further brace the unit, the strap bracing should be installed on the lower extension arms. To complete this, the #93 clamps with bushings should be attached to the outer extension pipes. On the inner pipes, as close to the outer pipe as possible, attach #92 clamps. Before tightening down the carriage bolts, install the strap bracing on each clamp (as shown in Figure 6). Secure the two braces together with a hex bolt and lock nut.

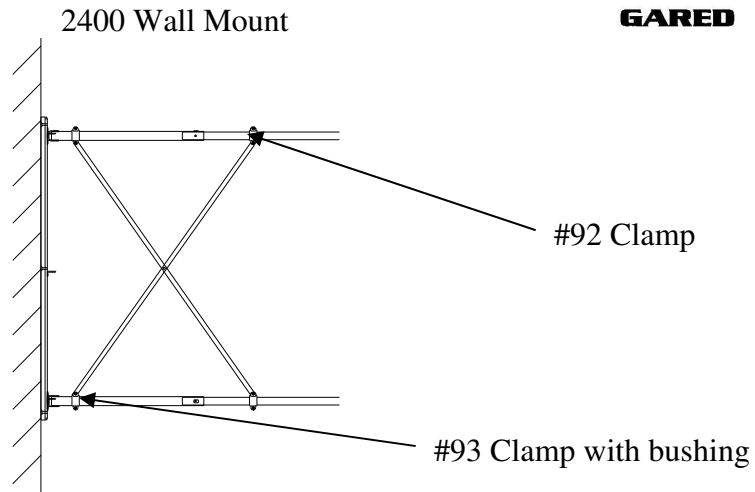

Figure 6. Cross bracing example.

- 16) The second pulley should be installed to one side or the other of the unit, in line with the first pulley. Attach the provided bracket to the 24" wood pad and mount to the wall vertically (as shown in Figure 7). Utilize a 5/16" quick link to connect the pulley to the bracket.

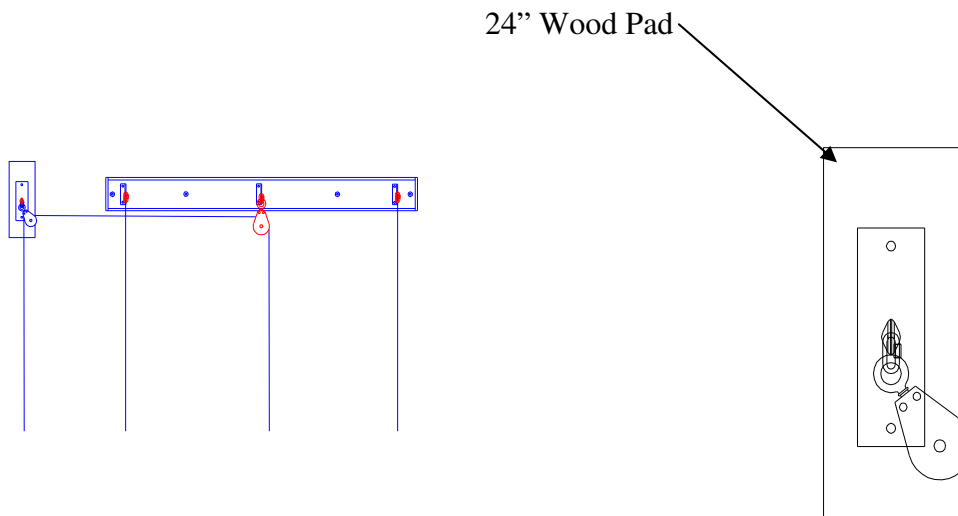

Figure 7 Example of second pulley location and attachments.

- 17) At this point, the winch should be installed on the wall. Draw the cable straight down from the second pulley and mark the location for the center of the winch.
- 18) Anchor the winch to the wall with the provided wood pad.



2400 Wall Mount



- 19) Wind the winch so that the cable is tight. Verify that the unit will fold up and down without binding to verify installation is complete.
- 20) Retighten the chains. Support may be removed.

OPERATION GUIDELINES

- 1) For all folding backstops, only a trained adult should operate the manual and electric winches.
- 2) Keep the areas below and around the units clear while they are in motion.
- 3) Do not over turn the manual winches. This could result in the supports running into each other and binding the unit. Also, do not allow slack in the cable to develop, as this could pose a safety hazard.
- 4) Always use the equipment in the manner intended. Gared Sports/ PSS does not assume any liability for improperly used or improperly maintained equipment.



2400 Wall Mount



MAINTENANCE

- 1) General inspection of equipment should be performed when the unit is used to ensure no catastrophic failures have occurred during the course of use between yearly inspections.
- 2) It is recommended that yearly inspections be conducted to determine if any bolts, chain links, or other hardware has become worn or loosened. A sample check sheet has been provided for you in this guide.
- 3) During yearly inspections, all moving parts should be inspected while in operation. Key points to look for include rotation points where bushings contact metal, winches, pulleys and quick links, and the cable. The cable should be carefully inspected for any fraying or degradation of the apparent quality of the cable.
- 4) Any loose bolts or nuts should be tightened.
- 5) Check sliding components (AAG) for wear and lubricate as needed.



MAINTENANCE CHECK SHEET

Date: _____

Unit: _____

Wood Pads / Anchors

-Wood pads, splitting, chipping, etc. OK Repair Replace

-Anchors/Bolts OK Repair Replace

Unit Supports / Brackets / Hinges

-Tubes; dents, stress spots, etc. OK Repair Replace

-Bolts; loose, deformed, etc. OK Repair Replace

-Brackets/Hinges; bent, not rotating, etc. OK Repair Replace

Chains

-Chains; deforming, broken/bent links OK Repair Replace

-Hardware; Quick links OK Repair Replace

Sliding Components; AAG (IF APPLICABLE)

-Lubrication OK Repair



Performance Sports Systems
9200 E. 146th Street
Noblesville, IN 46060

800-848-8034
www.perfsports.com



Gared Holdings, LLC

Gared Sports
707 North 2nd Street
St. Louis, MO 63102

800-325-2682
www.garedsports.com