

# STD-4B+ Mailboxes and Private Delivery Horizontal

## Product Overview

Used most commonly in townhomes, apartments, and university housing, horizontal and vertical mailboxes were the standard in centralized mail equipment for decades. Governed by USPS STD-4B+ regulations, these installations are prevalent throughout the nation; however, since the adoption of the STD-4C regulation, this equipment may no longer be used for Postal Delivery in new construction or major remodel projects (see pages 4 - 5 for additional details).

A major remodel refers to the adjustment of the rough opening of the current mailboxes. If this opening is not changed during the remodel, these horizontal mailboxes may simply be replaced one-for-one in order to maintain Postal Delivery. However, any adjustment to the rough opening in the wall will require that new STD-4C mailbox equipment be utilized. (It is highly

recommended that local Postal Officials be consulted to ensure mail delivery is not disrupted.) In addition, serious consideration should be given to the complete replacement of these older mailbox products as the level of security which accompanies them is not as high as it is in new STD-4C or CBU equipment, nor are the compartment sizes as large.

As the design standard for centralized mailbox installations since 1934, Florence is proud to continue to offer quality replacement options for all your centralized mailbox needs. Simply measure the existing rough opening used, determine the number of resident compartments needed, and then visit our industry exclusive online configurator to determine the best product solution for your project...no matter the original manufacturer.



Custom Home Accessories, Inc.  
1.800.265.0041 • [www.mailboxes.info](http://www.mailboxes.info)





## Suggested Applications

- Residential
- Multi-Family
- Industrial
- Dormitories
- Office Mail Room
- Government Agencies
- Colleges/Universities
- K-12 Schools
- Financial Institutions
- Military Bases
- Healthcare Facilities

## In this section:



1600-8x5

# Horizontal Mailboxes

## *for Postal and Private Delivery*



## Mailboxes for Replacement and Private Applications

Florence has been designing and manufacturing mailboxes for centralized delivery since 1934 and is proud to continue to offer four different lines of horizontal mailboxes to fit all your postal replacement and private delivery applications.

Each horizontal series has an extensive array of features and options and are all highly configurable to best suit your specific project. Built to USPS STD-4B+, these mailboxes are an economical solution for your centralized mail delivery needs.

## Product Features

- Smooth anodized aluminum finish
- Recess-mounted units with front- or rear-loading access
- Configurable unit height and width options
- 5-pin cylinder tenant cam lock with two keys (1,000 key changes)
- Clear plastic number slots for tenant ID cards

### Did you know?

Provide a face-lift for your older horizontal mailbox installation with replacement parts such as doors, locks, keys and hardware from Florence.

## Optional Features

- Ten architectural powder coat color finishes (see page 43)
- Integrated parcel locker and mail collection boxes
- Rear cover options available for rear-loading access units
- Vision windows (standard and oversized) for private applications
- Multiple lock options; including customer-supplied opportunities for private applications
- Multiple ID options including engraving (see page 22 for engraved font options)
- Snap-on outer trim kits and/or decorative inner trim kits for unit installation





## Postal Mail Delivery



If USPS Letter Carriers deliver mail to each existing tenant compartment in a horizontal mailbox installation, STD-4B+ equipment may only be used to replace the installation if no modification of the existing wall opening will be made. However, if the rough opening dimensions are changed, new STD-4C equipment will be required (see pages 4-5). Be sure to check with local Postal Officials prior to planning mailbox installation to ensure local requirements and proper placement are met.



## Private Mail Delivery



Private mail delivery is when the mail is delivered to one centralized business location by the USPS letter carrier and then the facility manager or entrusted individual distributes the mail to all the individual tenant compartments. (Most commonly used in university dorm settings). Mailboxes for private delivery do not have to conform to current postal regulations and therefore often vary in size from standard USPS Approved equipment. A broader range of options are also available for private delivery applications.

Note: Horizontal mailbox installations (whether for postal or private delivery) should be protected from direct exposure to the weather; Florence Manufacturing is not responsible for damage caused by weather conditions as these products are rated for indoor use only.

## Color Options

*Anodized Aluminum is standard for horizontal mailboxes.*

*You may also customize your mailbox with 10 different architectural powder coat flat finishes.*

Anodized Aluminum Metal Finish	<b>Black</b> PMS Black 6C	<b>Gold</b> PMS 871C	<b>Sandstone</b> PMS 7501C
	<b>Blonde Gold</b> PMS 7536C	<b>Gold Speck</b> PMS 7-5C	<b>Antique Bronze</b> PMS 8622C
<b>Silver Speck</b> PMS 877C	<b>Dark Bronze</b> PMS Black 7C	<b>Postal Grey</b> PMS 413C	<b>Antique Copper</b> PMS 876C

# Horizontal Mailboxes

## Features and Options

### Standard Lock Details



**K30809**  
Standard tenant cam lock for 1400/1500, 1450/1550, and 1600/1700 series.



**K1111-116**  
Standard tenant cam lock for American Device 2600 series.

All standard tenant cam locks come with two keys (1,000 key changes); additional keys are available (sold separately).

For lock maintenance, graphite type lubricants only are recommended on all product locks. For additional assistance with locks, contact your local locksmith.

### Optional Lock Details

Select any of the following lock options for private delivery applications.

#### Combination Lock



30815

#### Thumb-latch Lock



30799

#### Spring-latch Locks

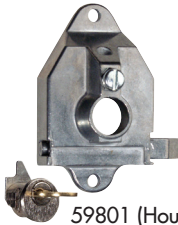

59801 (Housing)  
30803 (Lock)



1111-114  
(2600 Series)

### Customer-Supplied Locks

The following manufactured, customer-supplied locks (listed by cylinder number) are compatible with Florence mailboxes (lock sample must be sent to confirm functionality prior to ordering):

<b>Arrow</b>	AD615
<b>Best</b>	A7117
<b>Falcon</b>	6060,A11485,A11491,C982
<b>Sargent</b>	4101
<b>Schlage</b>	20-066,20-067,20-069
<b>Weiser</b>	11485,11491
<b>Yale</b>	C1810

### Identification Options

Select plastic number slots or engraving options only for Postal Delivery; all ID options are available for private delivery applications.



Plastic Number Slot with or without Engraved Tabs (5/8" H x 2" W)

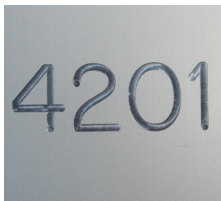

Engraving (3/4" H) (font options on page 22)



Engraved with Color Fill (Black or White)



Clear Vision Windows (5/8" H x 2" W)



Oversized Vision Window with Engraving (1" H x 2" W)

## Front-load vs. Rear-load



### Front-loading Horizontal Modules

In order for the USPS Letter Carriers to access all tenant compartments within a unit simultaneously, front-loading units are built with gates that swing open on one continuous hinge. As these units must also include a master access door for the carrier to open, it reduces the number of available tenant doors in each unit by one.



### Rear-loading Horizontal Modules

Units which require mail delivery to the rear of the unit can be used in either postal or private delivery. The rear of the unit must open into a secured room/no public access. Rear-load units can be prepared with a lift-off cover, hinged cover, or no cover. (To aid in access to the secure room, Florence also provides key keepers. See page 63 for options and details.)

## Selecting a Size



Horizontal mailboxes are popular due to the various unit heights and widths available. If all units in an existing installation are to be replaced, simply measure the rough opening of the wall the mailboxes are currently mounted into, determine the number of tenant compartments needed, and visit the online industry-exclusive Florence configurator. By entering the outside dimensions, or requesting a specific number of rows, a suitable replacement installation can quickly and easily be found.

## Security Upgrade Kit

If replacing the entire existing STD-4B horizontal installation to improve security is not an option, simply install a security upgrade kit. This Florence exclusive product will improve unit strength and provide greater resistance to the most common methods of attack by bringing the unit into STD-4B+ compliance. Easy to install, this USPS Approved kit takes only a few tools and a little time and is designed to harden both the Postal Arrow Lock and Master Gate Door. (As all new horizontal mailboxes are manufactured to USPS STD-4B+ security standards, they already include this upgrade kit.)

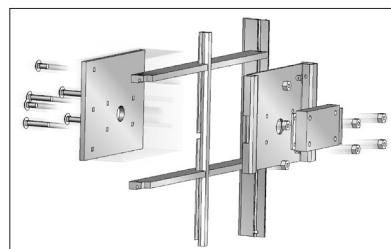

# Horizontal Mailboxes

*for Postal Delivery*



140075HSA (front loading)

## 1400/1500 Series

As an indoor solution, these traditional-style mailboxes have been used for decades and are most popular in apartment complexes, and university / military housing due to their highly configurable nature. While this series is prepped for Postal Delivery, it can also easily be converted for Private Delivery making it an extremely adaptable solution.

### Product Features

- Anodized aluminum finish; ten powder coat color finishes optional (see page 43 for color swatches)
- 5-pin cylinder tenant cam lock with two keys (1,000 key changes)
- Clear plastic number slots
- Front-loading units prepared for USPS installed Arrow Lock; rear-loading unit optional
- 15-1/2" deep compartments
- Recess-mounted only

## Optional Directories

### D400

- Side-mount directory for 1400/1500
- Designed to hold up to 200 names
  - D400-1 40 name capacity
  - D400-2 80 name capacity
  - D400-3 120 name capacity
  - D400-4 160 name capacity
  - D400-5 200 name capacity



D400-4A

### D500

- Top-mount directory for 1400/1500
- Available in 3, 4, or 5 units wide
- Designed to hold up to 40 names
  - D500-3 24 name capacity
  - D500-4 32 name capacity
  - D500-5 40 name capacity



D500-5A

### D600

- Side-mount directory for 1400/1500
- Available in 4, 5, 6, or 7 units high
- Designed to hold up to 70 names
  - D600-4 40 name capacity
  - D600-5 50 name capacity
  - D600-6 60 name capacity
  - D600-7 70 name capacity



D600-4A

Note: All optional Directories are smooth aluminum construction that match horizontal door finish options selected. (See page 43 for architectural powder coat color finish options).

## Florence 1400/1500 Standard Horizontal Dimensions (front- and rear-load)

HEIGHT DIMENSION 5 UNITS HIGH Actual 2' 4", Rough* Opening 2' 4-1/4"			
Number of tenants		Model Number(s) and Quantities	Rough* Wall Opening Width
Front Load	Rear Load		
14	15	(1) 1500-53	1' 9"
19	20	(1) 1500-54	2' 3-1/2"
24	25	(1) 1500-55	2' 9-7/8"
38	40	(2) 1500-54	4' 6-3/4"
43	45	(1) 1500-54 (1) 1500-55	5' 1-1/8"
48	50	(2) 1500-55	5' 7-1/2"
62	65	(2) 1500-54 (1) 1500-55	7' 4-3/8"
72	75	(3) 1500-55	8' 5-1/8"
76	80	(4) 1500-54	9' 1-1/4"
81	85	(3) 1500-54 (1) 1500-55	9' 7-5/8"
91	95	(1) 1500-54 (3) 1500-55	10' 8-3/8"
96	100	(4) 1500-55	11' 2-3/4"
105	110	(3) 1500-54 (2) 1500-55	12' 5-1/4"
124	130	(4) 1500-54 (2) 1500-55	14' 8-1/2"
129	135	(3) 1500-54 (3) 1500-55	15' 2-7/8"
139	145	(1) 1500-54 (5) 1500-55	16' 3-5/8"
158	165	(2) 1500-54 (5) 1500-55	18' 6-7/8"
163	170	(1) 1500-54 (6) 1500-55	19' 1-1/4"
182	190	(2) 1500-54 (6) 1500-55	21' 4-1/2"
192	200	(8) 1500-55	22' 5-1/4"
196	205	(4) 1500-54 (5) 1500-55	23' 1-3/8"
211	220	(1) 1500-54 (8) 1500-55	24' 8-1/2"
216	225	(9) 1500-55	25' 2-7/8"

Dimensions apply to both 1400 and 1500 series.

\*To figure the actual width, deduct 1/4" from the rough opening dimension. Orders for non-standard mailbox configurations may not be accepted or may result in longer lead times.

Note: Horizontal mailbox installations should be protected from direct exposure to the weather; Florence Manufacturing is not responsible for damage caused by weather conditions as these products are rated for indoor use only.

HEIGHT DIMENSION 6 UNITS HIGH Actual 2' 9-3/8", Rough* Opening 2' 9-5/8"			
Number of tenants		Model Number(s) and Quantities	Rough* Wall Opening Width
Front Load	Rear Load		
23	24	(1) 1500-64	2' 3-1/2"
29	30	(1) 1500-65	2' 9-7/8"
34	36	(2) 1500-63	3' 5-3/4"
46	48	(2) 1500-64	4' 6-3/4"
52	54	(1) 1500-64 (1) 1500-65	5' 1-1/8"
58	60	(2) 1500-65	5' 7-1/2"
63	66	(1) 1500-63 (2) 1500-64	6' 3-1/2"
69	72	(3) 1500-64	6' 10"
75	78	(2) 1500-64 (1) 1500-65	7' 4-3/8"
87	90	(3) 1500-65	8' 5-1/8"
92	96	(4) 1500-64	9' 1-1/4"
98	102	(3) 1500-64 (1) 1500-65	9' 7-5/8"
104	108	(2) 1500-64 (2) 1500-65	10' 2"
110	114	(1) 1500-64 (3) 1500-65	10' 8-3/8"
116	120	(4) 1500-65	11' 2-3/4"
133	138	(2) 1500-64 (3) 1500-65	12' 11-5/8"
139	144	(1) 1500-64 (4) 1500-65	13' 6"
145	150	(5) 1500-65	14' 0-3/8"
150	156	(4) 1500-64 (2) 1500-65	14' 8-1/2"
156	162	(3) 1500-64 (3) 1500-65	15' 2-7/8"
174	180	(6) 1500-65	16' 10"
185	192	(3) 1500-64 (4) 1500-65	18' 0-1/2"
191	198	(2) 1500-64 (5) 1500-65	18' 6-7/8"
197	204	(1) 1500-64 (6) 1500-65	19' 1-1/4"
214	222	(3) 1500-64 (5) 1500-65	20' 10-1/8"
220	228	(2) 1500-64 (6) 1500-65	21' 4-1/2"
226	234	(1) 1500-64 (7) 1500-65	21' 10-7/8"
232	240	(8) 1500-65	22' 5-1/4"
239	248	(4) 1500-64 (5) 1500-65	23' 1-3/8"
249	258	(2) 1500-64 (7) 1500-65	24' 2-1/8"
255	264	(1) 1500-64 (8) 1500-65	24' 8-1/2"
261	270	(9) 1500-65	25' 2-7/8"

HEIGHT DIMENSION 7 UNITS HIGH Actual 3' 2-3/4", Rough* Opening 3' 3"			
Number of tenants		Model Number(s) and Quantities	Rough* Wall Opening Width
Front Load	Rear Load		
20	21	(1) 1500-73	1' 9"
27	28	(1) 1500-74	2' 3-1/2"
34	35	(1) 1500-75	2' 9-7/8"
40	42	(2) 1500-73	3' 5-3/4"
47	49	(1) 1500-73 (1) 1500-74	4' 0-1/4"
54	56	(2) 1500-74	4' 6-3/4"
61	63	(1) 1500-74 (1) 1500-75	5' 1-1/8"
68	70	(2) 1500-75	5' 7-1/2"
74	77	(1) 1500-73 (2) 1500-74	6' 3-1/2"
81	84	(3) 1500-74	6' 10"
88	91	(2) 1500-74 (1) 1500-75	7' 4-3/8"
95	98	(1) 1500-74 (2) 1500-75	7' 10-3/4"
102	105	(3) 1500-75	8' 5-1/8"
108	112	(4) 1500-74	9' 1-1/4"
115	119	(3) 1500-74 (1) 1500-75	9' 7-5/8"
122	126	(2) 1500-74 (2) 1500-75	10' 2"
129	133	(1) 1500-74 (3) 1500-75	10' 8-3/8"
136	140	(4) 1500-75	11' 2-3/4"
142	147	(4) 1500-74 (1) 1500-75	11' 10-7/8"
149	154	(3) 1500-74 (2) 1500-75	12' 5-1/4"
156	161	(2) 1500-74 (3) 1500-75	12' 11-5/8"
163	168	(1) 1500-74 (4) 1500-75	13' 6"
170	175	(5) 1500-75	14' 0-3/8"
176	182	(4) 1500-74 (2) 1500-75	14' 8-1/2"
183	189	(3) 1500-74 (3) 1500-75	15' 2-7/8"
190	196	(2) 1500-74 (4) 1500-75	15' 9-1/4"
197	203	(1) 1500-74 (5) 1500-75	16' 3-5/8"
204	210	(6) 1500-75	16' 10"
210	217	(4) 1500-74 (3) 1500-75	17' 6-1/8"
217	224	(3) 1500-74 (4) 1500-75	18' 0-1/2"
224	231	(2) 1500-74 (5) 1500-75	18' 6-7/8"
231	238	(1) 1500-74 (6) 1500-75	19' 1-1/4"
238	245	(7) 1500-75	19' 7-5/8"
244	252	(4) 1500-74 (4) 1500-75	20' 3-3/4"
251	259	(3) 1500-74 (5) 1500-75	20' 10-1/8"
258	266	(2) 1500-74 (6) 1500-75	21' 4-1/2"
265	273	(1) 1500-74 (7) 1500-75	21' 10-7/8"
272	280	(8) 1500-75	22' 5-1/4"
278	287	(4) 1500-74 (5) 1500-75	23' 1-3/8"
285	294	(3) 1500-74 (6) 1500-75	23' 7-3/4"
292	301	(2) 1500-74 (7) 1500-75	24' 2-1/8"
299	308	(1) 1500-74 (8) 1500-75	24' 8-1/2"
306	315	(9) 1500-75	25' 2-7/8"

### Custom Configurations Available Online

As all horizontal products can be configured for each individual project, only standard sizes are provided here. Visit the industry-exclusive online Configurator to complete your project. Contact Customer Service if your installation requires configurations outside those listed here as Florence's Engineering department can work to design a customized installation specific to your needs.

### 1400/1500 Door Sizes

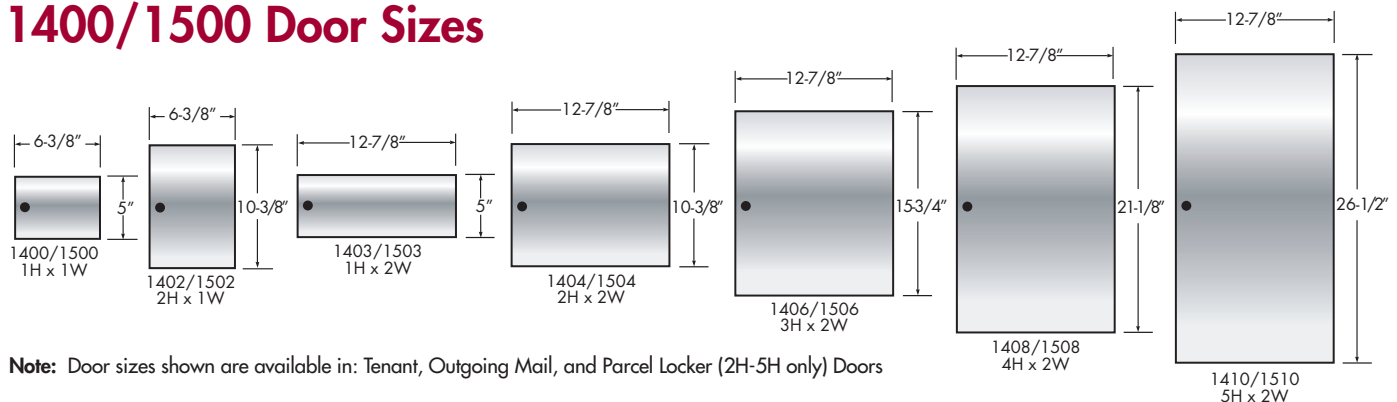

Note: Door sizes shown are available in: Tenant, Outgoing Mail, and Parcel Locker (2H-5H only) Doors



# Horizontal Mailboxes

for Postal Delivery



260074HSA  
(front loading)

## American Device 2600 Series

Created especially for use in higher risk and vandal-prone areas, the indoor American Device 2600 series features a high security vault-type design. Boasting an optional three-point locking system and an interlocking feature on the hinge-pin side of the door makes it virtually tamper-proof.

### Product Features

- Anodized aluminum finish; ten powder coat color finishes optional (see page 43 for color swatches)
- 5-pin cylinder tenant cam lock with two keys (1,000 key changes)
- Clear plastic number slots
- Front-loading units prepared for USPS installed Arrow Lock; rear-loading unit optional
- 15-1/2" deep compartments
- Recess-mounted only

### Optional Directory

Smooth aluminum construction matches horizontal door finish options selected.



D2600-5A

#### D2600

- Top-mount directory
- Available in 3, 4, or 5 units wide

### Optional Lock

Only the 2600 series offers an optional three-point vault lock for added security on all tenant doors.

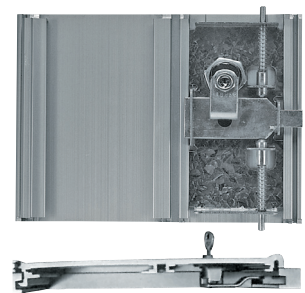

K1111-114

### 2600 Door Sizes

**Note:** Door sizes shown are available in: Tenant Doors, Outgoing Mail, and Parcel Locker Doors (2H-3H only).

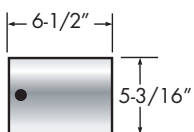

2600A  
1H x 1W

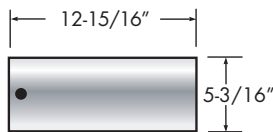

2603B  
1H x 2W

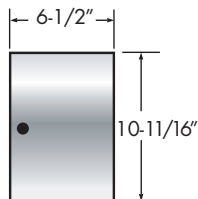

2602C  
2H x 1W

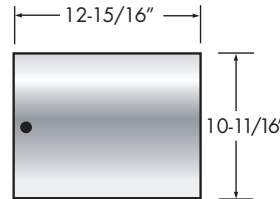

2604D  
2H x 2W

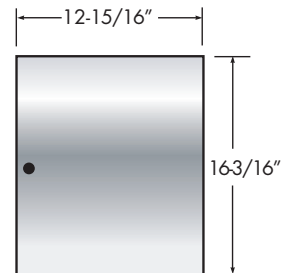

2606  
3H x 2W



## American Device 2600 Horizontal Dimensions (front- and rear-load)

**FRONT-LOAD**

5 UNITS HIGH	Height Dimensions, inches		6 UNITS HIGH	Height Dimensions, inches		7 UNITS HIGH	Height Dimensions, inches		Width Dimensions, Inches		
	Cabinet Net	28		Cabinet Net	33-1/2		Cabinet Net	39			
	Overall Trim	29-3/4		36-5/8	Overall Trim		35-1/4	42-1/8	Overall Trim	40-3/4	47-5/8
Rough Opening	28-3/4	35-5/8	Rough Opening	34-1/4	41-1/8	Rough Opening	39-3/4	46-5/8			
Number of Tenants*	Order Model Number	Arrangement and Number* of Compartments in Each Cabinet	Number of Tenants*	Order Model Number	Arrangement and Number* of Compartments in Each Cabinet	Number of Tenants*	Order Model Number	Arrangement and Number* of Compartments in Each Cabinet	Number of Postal Master Locks Required	Overall Trim Width	Rough Opening Width
14	2600F5-15	15	17	2600F6-18	18	20	2600F7-21	21	1	22-3/4	21-3/4
19	2600F5-20	20	23	2600F6-24	24	27	2600F7-28	28	1	29-1/4	28-1/4
24	2600F5-25	25	29	2600F6-30	30	34	2600F7-35	35	1	35-3/4	34-3/4
28	2600F5-30	15-15	34	2600F6-36	18-18	40	2600F7-42	21-21	2	45-1/2	44-1/2
33	2600F5-35	15-20	40	2600F6-42	18-24	47	2600F7-49	21-28	2	52	51
38	2600F5-40	20-20	46	2600F6-48	24-24	54	2600F7-56	28-28	2	58-1/2	57-1/2
43	2600F5-45	20-25	52	2600F6-54	24-30	61	2600F7-63	28-35	2	65	64
48	2600F5-50	25-25	58	2600F6-60	30-30	68	2600F7-70	35-35	2	71-1/2	70-1/2
52	2600F5-55	20-20-15	63	2600F6-66	24-24-18	74	2600F7-77	28-28-21	3	81-1/4	80-1/4
57	2600F5-60	20-20-20	69	2600F6-72	24-24-24	81	2600F7-84	28-28-28	3	87-3/4	86-3/4
62	2600F5-65	20-20-25	75	2600F6-78	24-24-30	88	2600F7-91	28-28-35	3	94-1/4	93-1/4
67	2600F5-70	20-25-25	81	2600F6-84	24-30-30	95	2600F7-98	28-35-35	3	99-3/4	99-3/4
72	2600F5-75	25-25-25	87	2600F6-90	30-30-30	102	2600F7-105	35-35-35	3	107-1/4	106-1/4
76	2600F5-80	20-20-20-20	92	2600F6-96	24-24-24-24	108	2600F7-112	28-28-28-28	4	117	116
81	2600F5-85	20-20-20-25	98	2600F6-102	24-24-24-30	115	2600F7-119	28-28-28-35	4	123-1/2	122-1/2
86	2600F5-90	20-20-25-25	104	2600F6-108	24-24-30-30	122	2600F7-126	28-28-35-35	4	130	129
91	2600F5-95	20-25-25-25	110	2600F6-114	24-30-30-30	129	2600F7-133	28-35-35-35	4	136-1/2	135-1/2
96	2600F5-100	25-25-25-25	116	2600F6-120	30-30-30-30	136	2600F7-140	35-35-35-35	4	143	142
100	2600F5-105	25-25-25-15-15	121	2600F6-126	24-24-24-24-30	142	2600F7-147	28-28-28-28-35	5	152-3/4	151-3/4
105	2600F5-110	25-25-25-20-15	127	2600F6-132	24-24-24-30-30	149	2600F7-154	28-28-28-35-35	5	159-1/4	158-1/4
110	2600F5-115	25-25-25-20-20	133	2600F6-138	24-24-30-30-30	156	2600F7-161	28-28-35-35-35	5	165-3/4	164-3/4
115	2600F5-120	25-25-25-25-20	139	2600F6-144	24-30-30-30-30	163	2600F7-168	28-35-35-35-35	5	172-1/4	171-1/4
120	2600F5-125	25-25-25-25-25	145	2600F6-150	30-30-30-30-30	170	2600F7-175	35-35-35-35-35	5	178-3/4	177-3/4
124	2600F5-130	25-25-25-25-15-15	150	2600F6-156	24-24-24-24-30-30	176	2600F7-182	28-28-28-28-35-35	6	188-1/2	187-1/2
129	2600F5-135	25-25-25-25-20-15	156	2600F6-162	24-24-24-30-30-30	183	2600F7-189	28-28-28-35-35-35	6	195	194
134	2600F5-140	25-25-25-25-20-20	162	2600F6-168	24-24-30-30-30-30	190	2600F7-196	28-28-35-35-35-35	6	201-1/2	200-1/2
139	2600F5-145	25-25-25-25-25-20	168	2600F6-174	24-30-30-30-30-30	197	2600F7-203	28-35-35-35-35-35	6	208	207
144	2600F5-150	25-25-25-25-25-25	174	2600F6-180	30-30-30-30-30-30	204	2600F7-210	35-35-35-35-35-35	6	214-1/2	213-1/2

**REAR-LOAD**

5 UNITS HIGH	Height Dimensions, inches		6 UNITS HIGH	Height Dimensions, inches		7 UNITS HIGH	Height Dimensions, inches		Width Dimensions, Inches		
	Cabinet Net	28		Cabinet Net	33-1/2		Cabinet Net	39			
	Overall Trim	31-3/4		Overall Trim	37-1/4		Overall Trim	42-3/4			
Rough Opening	29-1/2	Rough Opening	35	Rough Opening	40-1/2						
Number of Tenants	Order Model Number	Arrangement and Number of Compartments in Each Cabinet	Number of Tenants	Order Model Number	Arrangement and Number of Compartments in Each Cabinet	Number of Tenants	Order Model Number	Arrangement and Number of Compartments in Each Cabinet	Cabinet Net Width	Overall Trim Width	Rough Opening Width
15	2600R5-15	15	18	2600R6-18	18	21	2600R7-21	21	20	23-3/4	21-1/2
20	2600R5-20	20	24	2600R6-24	24	28	2600R7-28	28	26-1/2	30-1/4	28
25	2600R5-25	25	30	2600R6-30	30	35	2600R7-35	35	33	36-3/4	34-1/2
30	2600R5-30	15-15	36	2600R6-36	18-18	42	2600R7-42	21-21	40	43-3/4	41-1/2
35	2600R5-35	15-20	42	2600R6-42	18-24	49	2600R7-49	21-28	46-1/2	50-1/4	48
40	2600R5-40	20-20	48	2600R6-48	24-24	56	2600R7-56	28-28	53	56-3/4	54-1/2
45	2600R5-45	20-25	54	2600R6-54	24-30	63	2600R7-63	28-35	59-1/2	63-1/4	61
50	2600R5-50	25-25	60	2600R6-60	30-30	70	2600R7-70	35-35	66	69-3/4	67-1/2
55	2600R5-55	20-20-15	66	2600R6-66	24-24-18	77	2600R7-77	28-28-21	73	76-3/4	74-1/2
60	2600R5-60	20-20-20	72	2600R6-72	24-24-24	84	2600R7-84	28-28-28	79-1/2	83-1/4	81
65	2600R5-65	20-20-25	78	2600R6-78	24-24-30	91	2600R7-91	28-28-35	86	89-3/4	87-1/2
70	2600R5-70	20-25-25	84	2600R6-84	24-30-30	98	2600R7-98	28-35-35	92-1/2	96-1/4	94
75	2600R5-75	25-25-25	90	2600R6-90	30-30-30	105	2600R7-105	35-35-35	99	102-3/4	100-1/2
80	2600R5-80	20-20-20-20	96	2600R6-96	24-24-24-24	112	2600R7-112	28-28-28-28	106	109-3/4	107-1/2
85	2600R5-85	20-20-20-25	102	2600R6-102	24-24-24-30	119	2600R7-119	28-28-28-35	112-1/2	116-1/4	114
90	2600R5-90	20-20-25-25	108	2600R6-108	24-24-30-30	126	2600R7-126	28-28-35-35	119	122-3/4	120-1/2
95	2600R5-95	20-25-25-25	114	2600R6-114	24-30-30-30	133	2600R7-133	28-35-35-35	125-1/2	129-1/4	127
100	2600R5-100	25-25-25-25	120	2600R6-120	30-30-30-30	140	2600R7-140	35-35-35-35	132	135-3/4	133-1/2
105	2600R5-105	25-25-25-15-15	126	2600R6-126	24-24-24-24-30	147	2600R7-147	28-28-28-28-35	139	142-3/4	140-1/2
110	2600R5-110	25-25-25-20-15	132	2600R6-132	24-24-24-30-30	154	2600R7-154	28-28-28-35-35	145-1/2	149-1/4	147
115	2600R5-115	25-25-25-20-20	138	2600R6-138	24-24-30-30-30	161	2600R7-161	28-28-35-35-35	152	155-3/4	153-1/2
120	2600R5-120	25-25-25-25-20	144	2600R6-144	24-30-30-30-30	168	2600R7-168	28-35-35-35-35	158-1/2	162-1/4	160
125	2600R5-125	25-25-25-25-25	150	2600R6-150	30-30-30-30-30	175	2600R7-175	35-35-35-35-35	165	168-3/4	166-1/2
130	2600R5-130	25-25-25-25-15-15	156	2600R6-156	24-24-24-24-30-30	182	2600R7-182	28-28-28-28-35-35	172	175-3/4	173-1/2
135	2600R5-135	25-25-25-25-20-15	162	2600R6-162	24-24-24-30-30-30	189	2600R7-189	28-28-28-35-35-35	178-1/2	182-1/4	180
140	2600R5-140	25-25-25-25-20-20	168	2600R6-168	24-24-30-30-30-30	196	2600R7-196	28-28-35-35-35-35	185	188-3/4	186-1/2
145	2600R5-145	25-25-25-25-25-20	174	2600R6-174	24-30-30-30-30-30	203	2600R7-203	28-35-35-35-35-35	191-1/2	195-1/4	193
150	2600R5-150	25-25-25-25-25-25	180	2600R6-180	30-30-30-30-30-30	210	2600R7-210	35-35-35-35-35-35	198	201-3/4	199-1/2

# Horizontal Mailboxes

## for Private Delivery



1450125HSA (front loading)

## 1450/1550 Series

Popular in university settings, this indoor solution provides wonderful flexibility in creating an installation to fit specific project needs due to its highly configurable nature. Whether the setting calls for front-loading (1450 series) or rear-loading units (1550 series), Florence builds security into each option to ensure tenants receive a quality product built to last.

### Product Features

- Front- or Rear-load; recess-mounted only
- 5-pin cylinder tenant cam lock with two keys (1,000 key changes)
- Clear plastic number slots
- 15-1/2" deep compartments
- Front-loading units include private lock for master access
- Anodized aluminum finish

### Optional Features

- Snap-on outer trim kit
- Decorative inner trim kit for multiple unit installations
- Ten architectural powder coat color finishes (see page 43)
- Optional combination lock or use of customer-supplied locks

#### Did you know?

Florence has the largest network of distributors throughout the nation to provide unsurpassed local sales and customer service.

## 1450/1550 Door Sizes

Note: Door sizes shown are available in: Tenant, Outgoing Mail, and Parcel Locker (3H-5H only) Doors.

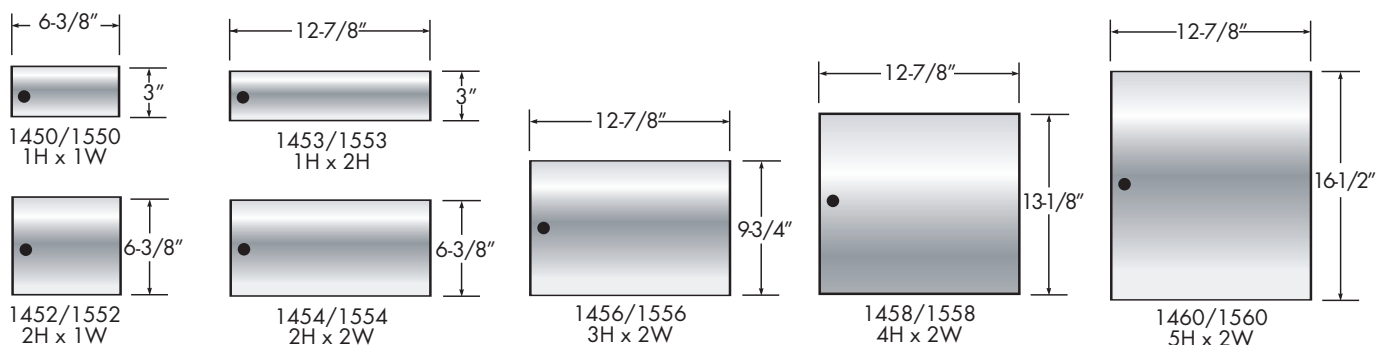

## Florence 1450/1550 Standard Horizontal Dimensions

HEIGHT DIMENSION 9 UNITS HIGH Actual 2' 7-1/2", Rough* Opening 2' 7-3/4"			
Number of tenants		Model Number(s) and Quantities	Rough* Wall Opening Width
Front Load	Rear Load		
26	27	(1) 1550-93	1' 9"
35	36	(1) 1500-94	2' 3-1/2"
44	45	(1) 1550-95	2' 9-7/8"
61	63	(1) 1550-93 (1) 1550-94	4' 0-1/4"
70	72	(2) 1550-94	4' 6-3/4"
79	81	(1) 1550-94 (1) 1550-95	5' 1-1/8"
88	90	(2) 1550-95	5' 7-1/2"
96	99	(1) 1550-93 (2) 1550-94	6' 3-1/2"
114	117	(2) 1550-94 (1) 1550-95	7' 4-3/8"
123	126	(1) 1550-94 (2) 1550-95	7' 10-3/4"
132	135	(3) 1550-95	8' 5-1/8"
140	144	(4) 1550-94	9' 1-1/4"
149	153	(3) 1550-94 (1) 1550-95	9' 7-5/8"
158	162	(2) 1550-94 (2) 1550-95	10' 2"
167	171	(1) 1550-94 (3) 1550-95	10' 8-3/8"
184	189	(4) 1550-94 (1) 1550-95	11' 10-7/8"
193	198	(3) 1550-94 (2) 1550-95	12' 5-1/4"
202	207	(2) 1550-94 (3) 1550-95	12' 11-5/8"
211	216	(1) 1550-94 (4) 1550-95	13' 6"
220	225	(5) 1550-95	14' 0-3/8"
228	234	(4) 1550-94 (2) 1550-95	14' 8-1/2"
237	243	(3) 1550-94 (3) 1550-95	15' 2-7/8"
246	252	(2) 1550-94 (4) 1550-95	15' 9-1/4"
255	261	(1) 1550-94 (5) 1550-95	16' 3-5/8"
264	270	(6) 1550-95	16' 10"

HEIGHT DIMENSION 10 UNITS HIGH Actual 2' 10-7/8", Rough* Opening 2' 11-1/8"			
Number of tenants		Model Number(s) and Quantities	Rough* Wall Opening Width
Front Load	Rear Load		
29	30	(1) 1550-103	1' 9"
39	40	(1) 1550-104	2' 3-1/2"
49	50	(1) 1550-105	2' 9-7/8"
68	70	(1) 1550-103 (1) 1550-104	4' 0-1/4"
78	80	(2) 1550-104	4' 6-3/4"
88	90	(1) 1550-104 (1) 1550-105	5' 1-1/8"
98	100	(2) 1550-105	5' 7-1/2"
117	120	(3) 1550-104	6' 10"
127	130	(2) 1550-104 (1) 1550-105	7' 4-3/8"
137	140	(1) 1550-104 (2) 1550-105	7' 10-3/4"
147	150	(3) 1550-105	8' 5-1/8"
156	160	(4) 1550-104	9' 1-1/4"
166	170	(3) 1550-104 (1) 1550-105	9' 7-5/8"
186	190	(1) 1550-104 (3) 1550-105	10' 8-3/8"
196	200	(4) 1550-105	11' 2-3/4"
205	210	(2) 1550-103 (3) 1550-105	11' 10-5/8"
225	230	(2) 1550-104 (3) 1550-105	12' 11-5/8"
245	250	(5) 1550-105	14' 0-3/8"
254	260	(2) 1550-103 (4) 1550-105	14' 8-1/4"
274	280	(2) 1550-104 (4) 1550-105	15' 9-1/4"
284	290	(1) 1550-104 (5) 1550-105	16' 3-5/8"

Note: Horizontal mailbox installations should be protected from direct exposure to the weather; Florence Manufacturing is not responsible for damage caused by weather conditions as these products are rated for indoor use only.

HEIGHT DIMENSION 11 UNITS HIGH Actual 3' 2-1/4", Rough* Opening 3' 2-1/2"			
Number of tenants		Model Number(s) and Quantities	Rough* Wall Opening Width
Front Load	Rear Load		
32	33	(1) 1550-113	1' 9"
43	44	(1) 1550-114	2' 3-1/2"
54	55	(1) 1550-115	2' 9-7/8"
64	66	(2) 1550-113	3' 5-3/4"
75	77	(1) 1550-113 (1) 1550-114	4' 0-1/4"
86	88	(2) 1550-114	4' 6-3/4"
97	99	(1) 1550-114 (1) 1550-115	5' 1-1/8"
108	110	(2) 1550-115	5' 7-1/2"
118	121	(1) 1550-113 (2) 1550-114	6' 3-1/2"
129	132	(3) 1550-114	6' 10"
140	143	(2) 1550-114 (1) 1550-115	7' 4-3/8"
151	154	(1) 1550-114 (2) 1550-115	7' 10-3/4"
162	165	(3) 1550-115	8' 5-1/8"
172	176	(4) 1550-114	9' 1-1/4"
183	187	(3) 1550-114 (1) 1550-115	9' 7-5/8"
194	198	(2) 1550-114 (2) 1550-115	10' 2"
205	209	(1) 1550-114 (3) 1550-115	10' 8-3/8"
216	220	(4) 1550-115	11' 2-3/4"
226	231	(2) 1550-113 (3) 1550-115	11' 10-5/8"
237	242	(3) 1550-114 (2) 1550-115	12' 5-1/4"
248	253	(2) 1550-114 (3) 1550-115	12' 11-5/8"
270	275	(5) 1550-115	14' 0-3/8"
280	286	(4) 1550-114 (2) 1550-115	14' 8-1/2"
291	297	(3) 1550-114 (3) 1550-115	15' 2-7/8"
302	308	(2) 1550-114 (4) 1550-115	15' 9-1/4"
313	319	(1) 1550-114 (5) 1550-115	16' 3-5/8"
324	330	(6) 1550-115	16' 10"

HEIGHT DIMENSION 12 UNITS HIGH Actual 3' 5-5/8", Rough* Opening 3' 5-7/8"			
Number of tenants		Model Number(s) and Quantities	Rough* Wall Opening Width
Front Load	Rear Load		
35	36	(1) 1550-123	1' 9"
47	48	(1) 1550-124	2' 3-1/2"
59	60	(1) 1550-125	2' 9-7/8"
82	84	(1) 1550-123 (1) 1550-124	4' 0-1/4"
94	96	(2) 1550-124	4' 6-3/4"
106	108	(1) 1550-124 (1) 1550-125	5' 1-1/8"
118	120	(2) 1550-125	5' 7-1/2"
141	144	(3) 1550-124	6' 10"
153	156	(2) 1550-124 (1) 1550-125	7' 4-3/8"
165	168	(1) 1550-124 (2) 1550-125	7' 10-3/4"
177	180	(3) 1550-125	8' 5-1/8"
188	192	(4) 1550-124	9' 1-1/4"
200	204	(3) 1550-124 (1) 1550-125	9' 7-5/8"
212	216	(2) 1550-124 (2) 1550-125	10' 2"
224	228	(1) 1550-124 (3) 1550-125	10' 8-3/8"
236	240	(4) 1550-125	11' 2-3/4"
247	252	(4) 1550-124 (1) 1550-125	11' 10-7/8"
259	264	(3) 1550-124 (2) 1550-125	12' 5-1/4"
271	276	(2) 1550-124 (3) 1550-125	12' 11-5/8"
283	288	(1) 1550-124 (4) 1550-125	13' 6"
295	300	(5) 1550-125	14' 0-3/8"
306	312	(4) 1550-124 (2) 1550-125	14' 8-1/2"
318	324	(3) 1550-124 (3) 1550-125	15' 2-7/8"
330	336	(2) 1550-124 (4) 1550-125	15' 9-1/4"
342	348	(1) 1550-124 (5) 1550-125	16' 3-5/8"
354	360	(6) 1550-125	16' 10"

## 1450/1550 Custom Sizes

As the most common standard sizes available are noted in the charts, additional custom cabinet sizes and door options are available online to create the perfect mailbox layout. Use the Minimum and Maximum values to determine if a custom option is right for your project and then visit the Florence exclusive online configurator to create the perfect installation.

Contact Customer Service if your installation requires configurations outside those listed here as Florence's Engineering department can work to design a customized installation specific to your needs.

**Minimum Rows High:** 5      1' 8-7/16" H  
**Maximum Rows High:** 12      3' 8-1/8" H

**Minimum Columns Wide:** 2      1' 2-7/8" W  
**Maximum Columns Wide:** 5      3' 0-1/8" W

**Minimum Tenant Doors (1Hx1W) Per Cabinet:** 10  
**Maximum Tenant Doors (1Hx1W) Per Cabinet:** 60



## Mailbox Replacement Parts



No matter how old your horizontal mailbox installation may be, chances are Florence can bring new life to the unit with replacement parts such as doors, locks, keys, and hardware. When the situation calls for simple repairs rather than replacing the entire unit, contact an Authorized Florence Dealer or visit our website for assistance.

# Horizontal Mailboxes

*for Private Delivery*



160085HSA  
(front loading)

## 1600/1700 Series

Keep your mail area organized with this highly configurable indoor solution. Available in front-loading (1600 series) or rear-loading (1700 series) units, personalize the installation with options to suit your project. Whether replacing older mailboxes, or creating a new private delivery center, Florence provides the same secure, quality product it has for decades.

### Product Features

- Front- or Rear-load; recess-mounted only
- 5-pin cylinder tenant cam lock with two keys (1,000 key changes)
- Clear plastic number slots
- 15-1/2" deep compartments
- Anodized aluminum finish

### Optional Features

- Snap-on outer trim kit
- Decorative inner trim kit for multiple unit installations
- Ten architectural powder coat color finishes (see page 43)
- Optional combination lock or use of customer-supplied locks

## 1600/1700 Door Sizes

**Note:** Door sizes shown are available in: Tenant, Outgoing Mail, and Parcel Locker (2H-4H only) Doors.

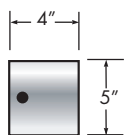

1600/1700  
1H x 1W

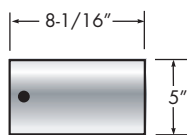

1603/1703  
1H x 2W

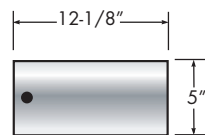

1605/1705  
1H x 3W

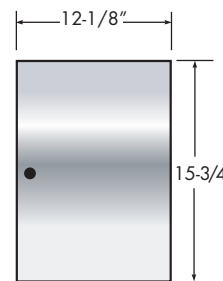

1609/1709  
3H x 3W

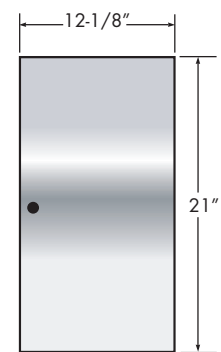

1611/1711  
4H x 3W

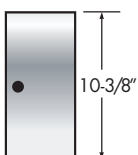

1602/1702  
2H x 1W

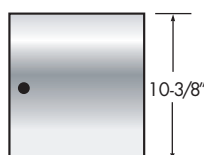

1604/1704  
2H x 2W

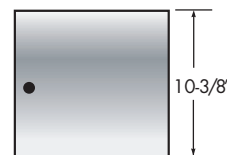

1607/1707  
2H x 3W

## Florence 1600/1700 Standard Horizontal Dimensions

HEIGHT DIMENSION 7 UNITS HIGH Actual 3' 2-3/4", Rough* Opening 3' 3"			
Number of tenants		Model Number(s) and Quantities	Rough* Wall Opening Width
Front Load	Rear Load		
20	21	(1) 1700-73	1' 2"
27	28	(1) 1700-74	1' 6-1/16"
34	35	(1) 1700-75	1' 10-1/8"
41	42	(1) 1700-76	2' 2-3/16"
47	49	(1) 1700-73 (1) 1700-74	2' 7-13/16"
54	56	(2) 1700-74	2' 11-7/8"
61	63	(1) 1700-74 (1) 1700-75	3' 3-15/16"
68	70	(2) 1700-75	3' 8"
75	77	(1) 1700-75 (1) 1700-76	4' 0-1/16"
82	84	(2) 1700-76	4' 4-1/8"
88	91	(2) 1700-74 (1) 1700-75	4' 9-3/4"
102	105	(3) 1700-75	5' 5-7/8"
116	119	(2) 1700-76 (1) 1700-75	6' 2"
129	133	(3) 1700-75 (1) 1700-74	6' 11-1/16"
136	140	(4) 1700-75	7' 3-3/4"
143	147	(3) 1700-75 (1) 1700-76	7' 7-13/16"
150	154	(2) 1700-75 (2) 1700-76	7' 11-7/8"
157	161	(3) 1700-76 (1) 1700-75	8' 3-15/16"
164	168	(4) 1700-76	8' 8"
177	182	(4) 1700-75 (1) 1700-76	9' 5-11/16"
184	189	(3) 1700-75 (2) 1700-76	9' 9-3/4"
191	196	(3) 1700-76 (2) 1700-75	10' 1-13/16"
198	203	(4) 1700-76 (1) 1700-75	10' 5-7/8"
205	210	(5) 1700-76	10' 9-15/16"

HEIGHT DIMENSION 8 UNITS HIGH Actual 3' 8-1/8", Rough* Opening 3' 8-3/8"			
Number of tenants		Model Number(s) and Quantities	Rough* Wall Opening Width
Front Load	Rear Load		
62	64	(2) 1700-84	2' 11-7/8"
70	72	(1) 1700-84 (1) 1700-85	3' 3-15/16"
78	80	(2) 1700-85	3' 8"
86	88	(1) 1700-85 (1) 1700-86	4' 0-1/16"
94	96	(2) 1700-86	4' 4-1/8"
101	104	(2) 1700-84 (1) 1700-85	4' 9-3/4"
109	112	(2) 1700-85 (1) 1700-84	5' 1-13/16"
117	120	(3) 1700-85	5' 5-7/8"
125	128	(2) 1700-85 (1) 1700-86	5' 9-15/16"
133	136	(2) 1700-86 (1) 1700-85	6' 2"
141	144	(3) 1700-86	6' 6-1/16"
148	152	(3) 1700-85 (1) 1700-84	6' 11-1/16"
156	160	(4) 1700-85	7' 3-3/4"
172	176	(2) 1700-85 (2) 1700-86	7' 11-7/8"
180	184	(3) 1700-86 (1) 1700-85	8' 3-15/16"
188	192	(4) 1700-86	8' 8"
203	208	(4) 1700-85 (1) 1700-86	9' 5-11/16"
211	216	(3) 1700-85 (2) 1700-86	9' 9-3/4"
219	224	(3) 1700-86 (2) 1700-85	10' 1-13/16"
227	232	(4) 1700-86 (1) 1700-85	10' 5-7/8"
242	248	(5) 1700-85 (1) 1700-86	11' 3-9/16"
250	256	(4) 1700-85 (2) 1700-86	11' 7-5/8"
258	264	(3) 1700-85 (3) 1700-86	11' 11-1/16"
266	272	(2) 1700-85 (4) 1700-86	12' 3-3/4"
274	280	(1) 1700-85 (5) 1700-86	12' 7-13/16"
282	288	(6) 1700-86	12' 11-7/8"

HEIGHT DIMENSION 9 UNITS HIGH Actual 4' 1-1/2", Rough* Opening 4' 1-3/4"			
Number of tenants		Model Number(s) and Quantities	Rough* Wall Opening Width
Front Load	Rear Load		
70	72	(2) 1700-94	2' 11-7/8"
79	81	(1) 1700-94 (1) 1700-95	3' 3-15/16"
88	90	(2) 1700-95	3' 8"
97	99	(1) 1700-95 (1) 1700-96	4' 0-1/16"
106	108	(2) 1700-96	4' 4-1/8"
114	117	(2) 1700-94 (1) 1700-95	4' 9-3/4"
123	126	(2) 1700-95 (1) 1700-94	5' 1-13/16"
132	135	(3) 1700-95	5' 5-7/8"
141	144	(2) 1700-95 (1) 1700-96	5' 9-15/16"
150	153	(2) 1700-96 (1) 1700-95	6' 2"
159	162	(3) 1700-96	6' 6-1/16"
167	171	(3) 1700-95 (1) 1700-94	6' 11-1/16"
185	189	(3) 1700-95 (1) 1700-96	7' 7-13/16"
194	198	(2) 1700-95 (2) 1700-96	7' 11-7/8"
203	207	(3) 1700-96 (1) 1700-95	8' 3-15/16"
212	216	(4) 1700-96	8' 8"
220	225	(5) 1700-95	9' 1-5/8"
229	234	(4) 1700-95 (1) 1700-96	9' 5-11/16"
238	243	(3) 1700-95 (2) 1700-96	9' 9-3/4"
247	252	(3) 1700-96 (2) 1700-95	10' 1-13/16"
256	261	(4) 1700-96 (1) 1700-95	10' 5-7/8"
265	270	(5) 1700-96	10' 9-15/16"

HEIGHT DIMENSION 10 UNITS HIGH Actual 4' 7", Rough* Opening 4' 7-1/4"			
Number of tenants		Model Number(s) and Quantities	Rough* Wall Opening Width
Front Load	Rear Load		
68	70	(1) 1700-103 (1) 1700-104	2' 7-13/16"
78	80	(2) 1700-104	2' 11-7/8"
88	90	(1) 1700-104 (1) 1700-105	3' 3-15/16"
98	100	(2) 1700-105	3' 8"
108	110	(1) 1700-105 (1) 1700-106	4' 0-1/16"
118	120	(2) 1700-106	4' 4-1/8"
127	130	(2) 1700-104 (1) 1700-105	4' 9-3/4"
137	140	(2) 1700-105 (1) 1700-104	5' 1-13/16"
147	150	(3) 1700-105	5' 5-7/8"
157	160	(2) 1700-105 (1) 1700-106	5' 9-15/16"
167	170	(2) 1700-106 (1) 1700-105	6' 2"
177	180	(3) 1700-106	6' 6-1/16"
186	190	(3) 1700-105 (1) 1700-104	6' 11-1/16"
196	200	(4) 1700-105	7' 3-3/4"
206	210	(3) 1700-105 (1) 1700-106	7' 7-13/16"
216	220	(2) 1700-105 (2) 1700-106	7' 11-7/8"
226	230	(3) 1700-106 (1) 1700-105	8' 3-15/16"
236	240	(4) 1700-106	8' 8"
245	250	(5) 1700-105	9' 1-5/8"
255	260	(4) 1700-105 (1) 1700-106	9' 5-11/16"
265	270	(3) 1700-105 (2) 1700-106	9' 9-3/4"
275	280	(3) 1700-106 (2) 1700-105	10' 1-13/16"
285	290	(4) 1700-106 (1) 1700-105	10' 5-7/8"
295	300	(5) 1700-106	10' 9-15/16"
304	310	(5) 1700-105 (1) 1700-106	11' 3-9/16"
314	320	(4) 1700-105 (2) 1700-106	11' 7-5/8"
324	330	(3) 1700-105 (3) 1700-106	11' 11-1/16"
334	340	(2) 1700-105 (4) 1700-106	12' 3-3/4"
344	350	(1) 1700-105 (5) 1700-106	12' 7-13/16"
354	360	(6) 1700-106	12' 11-7/8"

## 1600/1700 Custom Sizes

As the most common standard sizes available are noted in the charts, additional custom cabinet sizes and door options are available online to create the perfect mailbox layout. Use the Minimum and Maximum values to determine if a custom option is right for your project and then visit the Florence exclusive online configurator to create the perfect installation.

Contact Customer Service if your installation requires configurations outside those listed here as Florence's Engineering department can work to design a customized installation specific to your needs.

**Minimum Rows High:** 3      1' 7-5/8" H  
**Maximum Rows High:** 10      5' 8-1/4" H

**Minimum Columns Wide:** 2      1' 0-1/8" W  
**Maximum Columns Wide:** 6      2' 4-7/16" W

**Minimum Tenant Doors (1Hx1W) Per Cabinet:** 6  
**Maximum Tenant Doors (1Hx1W) Per Cabinet:** 60



Note: Horizontal mailbox installations should be protected from direct exposure to the weather; Florence Manufacturing is not responsible for damage caused by weather conditions as these products are rated for indoor use only.

## Request a Product Quote



Have a large project that needs to be bid? Simply complete a short online form and an Authorized Florence Dealer will quickly provide you with comprehensive project estimates, product recommendations, and/or volume pricing discounts. These product experts are often located in your backyard and happy to help with your project from conception to construction.

# Vertical Mailboxes

## for Postal Delivery



1250-5HA

## 1250 Series

Vertical mailboxes are most commonly used to replace older vertical mailboxes and are for Postal Delivery. As these units are top-loading, they should be protected from the weather.

### Standard Features

- Fully-recessed (6-3/4" D)
- Door Size: 16" H x 5-1/2" W
- Compartment Size: 16" H x 5-1/2" W x 6" D
- Clear anodized aluminum finish
- 5-pin cylinder tenant cam locks with two keys (1,000 key changes)
- Resident name and number ID card holders

### Optional Features

- Semi-recessed (3-3/4" D)
- Surface-mount with collar
- Pushbuttons
- Integral directories
- Integral collection doors
- Engraved ID options
- Ten architectural powder coat finishes



### 1250SMS Series

1250 series available in surface-mount option using SMS-125 collar



### 1255 Series

1255 series available with optional integrated 40 name directory



### 1260 Series

1260 series available with double-wide door and outgoing mail slot

### Color Options

Anodized Aluminum is standard for vertical mailboxes.

You may also customize your mailbox with 10 different architectural powder coat flat finishes.



# Vertical Mailboxes



1250-3HA



1250-4HA



1250-5HA



1250-6HA



1250-7HA

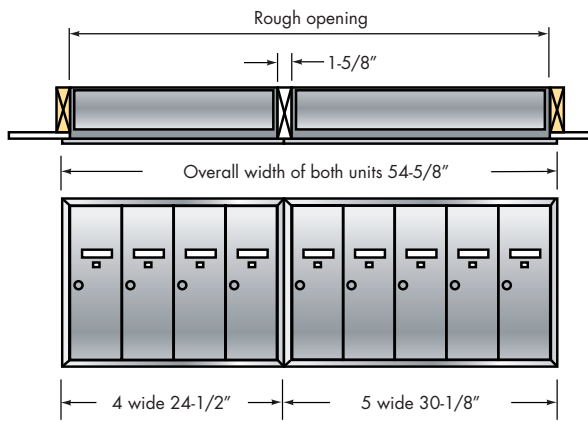
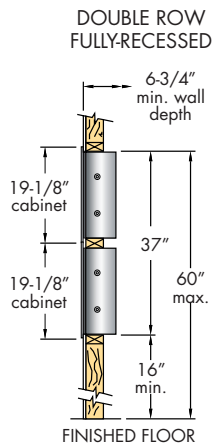
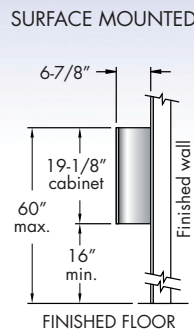
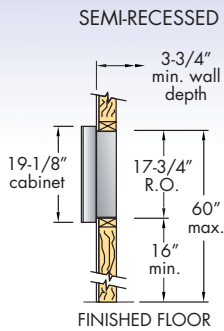
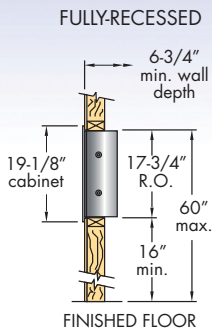

VERTICAL MAILBOX MODEL NUMBERS		
Number of Compartments	Standard Model Number	Surface Mount Model Number
3	12503H	12503SMSh
4	12504H	12504SMSh
5	12505H	12505SMSh
6	12506H	12506SMSh
7	12507H	12507SMSh

MOUNTING COLLAR MODEL NUMBERS		
Mailbox	Semi-Recess Mounted Collar	Surface Mounted Collar
12503H	SR1203	SMS1253
12504H	SR1204	SMS1254
12505H	SR1205	SMS1255
12506H	SR1206	SMS1256
12507H	SR1207	SMS1257

VERTICAL MAILBOX ALL CABINETS: 19-1/8" H 6-1/8" D				
Single Row	Double Row	Layout Per Row	Wall Cut Width	Overall Width
3	6	3	17-1/2"	19"
4	8	4	23"	24-1/2"
5	10	5	28-5/8"	30-1/8"
6	12	6	34-1/8"	35-5/8"
7	14	7	39-5/8"	41-1/8"
8	16	4-4	47-1/2"	49"
9	18	5-4	53-1/8"	54-5/8"
10	20	5-5	58-3/8"	60-1/4"
11	22	6-5	64-1/4"	65-3/4"
12	24	6-6	69-3/4"	71-1/4"
13	26	7-6	75-1/4"	76-3/4"
14	28	7-7	80-3/4"	82-1/4"
15	30	5-5-5	88-7/8"	90-3/8"
16	32	5-6-5	94-3/8"	95-7/8"
17	34	6-6-5	99-7/8"	101-3/8"
18	36	6-6-6	105-3/8"	106-7/8"
19	38	6-6-7	110-7/8"	112-3/8"
20	40	7-7-6	116-3/8"	117-7/8"
21	42	7-7-7	121-7/8"	123-3/8"
22	44	6-6-6-4	129-7/8"	131-3/8"
23	46	6-6-6-5	135-1/2"	137"
24	48	6-6-6-6	141"	142-1/2"
25	50	7-6-6-6	146-1/2"	148"
26	52	7-7-7-5	152"	153-1/2"
27	54	7-7-7-6	157-1/2"	159"
28	56	7-7-7-7	163"	164-1/2"
29	58	6-6-6-6-5	171-1/8"	172-5/8"
30	60	6-6-6-6-6	176-5/8"	178-1/8"

**Single Row**  
Wall Cut Depth = 6-3/4"  
Wall Cut Height = 17-3/4"  
Overall Height = 19-1/8"

**Double Row**  
Wall Cut Depth = 6-3/4"  
Wall Cut Height = 37"  
Overall Height = 39-1/4"

Note: Vertical mailbox installations should always be protected from direct exposure to the weather. Florence Manufacturing is not responsible for damage caused by weather conditions.

## Standard Lock

The 1250 vertical series comes standard with a K30809 lock.



K30809

## Optional Directory

- Designed for independent use or with vertical mailboxes
- Striated finish matches doors and trim of vertical mailboxes

Model #	Name Capacity	Dimensions
D300-1	40	19-1/8"H x 7-7/8"W
D300-2	80	19-1/8"H x 13-5/16"W
D300-3	120	19-1/8"H x 18-7/8"W
D300-4	160	19-1/8"H x 24-3/8"W
D300-5	200	19-1/8"H x 29-7/8"W



D300